

Low Signal Relay G6S

Surface Mount DPDT Relay

- High dielectric withstand voltage of 2,000 VAC between coil and contacts (standard type); 1,500 VAC between contacts of different polarity.
- Meets FCC Part 68 and Telcordia 2.5 kV surge withstand.
- European version certified for EN60950/EN41003 Supplementary Insulation at 250 V at Pollution Degree 2.
- Low power consumption of 140 mW (Non-latching)
- Available in through-hole and SMT terminals.
- Tape and reel or tube packaging.
- RoHS Compliant.

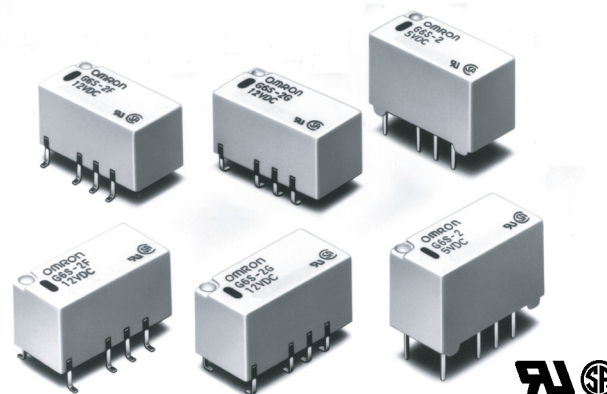

Ordering Information

Standard Version

Terminal	Model Contact form	Non-latching		Single coil latching	Dual coil latching
		Standard	European Version*		
Gull-wing	DPDT	G6S-2F	G6S-2F-Y	G6SU-2F	G6SK-2F
Inside "L"		G6S-2G	G6S-2G-Y	G6SU-2G	G6SK-2G
PCB through-hole		G6S-2	G6S-2-Y	G6SU-2	G6SK-2

* Certified for EN60950/EN41003 Supplementary Insulation at 250 V (pollution degree 2)

Notes: 1. When ordering, add the rated coil voltage to the model number.

Example: G6S-2F DC12
└─── Rated coil voltage

2. When ordering tape packing (surface mount models), add "-TR" to the model number.

Example: G6S-2F-TR DC12
└─── Tape packing

"-TR" is not part of the relay model number. Therefore, it is not marked on the relay case.

3. Dual coil latching models are available with a High-sensitivity coil. (140 mW; 200 mW for DC24)
 When ordering High-sensitivity dual coil latching models, add "-H" to the model number.

Example: G6SK-2G-H-TR DC5
└─── High-sensitivity coil

Model Number Legend

G6S - - - DC

1 2 3 4 5 6

1. Relay Function

- None: Non-latching
- U: Single coil latching
- K: Dual coil latching

3. Terminal Shape

- None: Through-hole
- F: Gull-wing surface mount
- G: Inside "L" surface mount

5. Packaging

- None: Tube packaging
- TR: Tape and reel packaging
(Surface mount models)

2. Contact Form

- 2: DPDT

4. Approved Standards

- None: UL/CSA
- Y: EN60950/EN41003
(Standard coil models - 5, 12, 24 VDC)

6. Rated Coil Voltage

- 3, 4.5, 5, 12, 24 VDC

Specification

■ Contact Data

Load	Resistive load (cos φ = 1)
Rated load	0.5 A at 125 VAC 2 A at 30 VDC
Contact material	Ag (Au clad)
Max. carry current	2 A
Max. operating voltage	250 VAC, 220 VDC
Max. operating current	2 A
Max. switching capacity	62.5 VA, 60 W
Min. permissible load	10 μA, 10 mVDC

Note: P level: $\lambda_{60} = 0.1 \times 10^{-6}$ /operation

This value was measured at a switching frequency of 120 operations/min and the criterion of contact resistance is 50 Ω. This value may vary depending on the operating environment. Always double-check relay suitability under actual operating conditions.

■ Coil Data

G6S - Standard Non-latching (G6S-2F, G6S-2G, G6S-2)

Rated voltage (VDC)	Rated current (mA)	Coil resistance (Ω)	Pick-up voltage	Dropout voltage	Maximum voltage	Power consumption (mW)
			% of rated voltage			
3	46.7	64.3	75% max.	10% min.	200% max. @ 23°C	Approx. 140
4.5	31.0	145				
5	28.1	178				
12	11.7	1,028				
24	8.3	2,880			170% max. @ 23°C	Approx. 200

G6SU - Standard Single Coil Latching (G6SU-2F, G6SU-2G, G6SU-2)

Rated voltage (VDC)	Rated current (mA)	Coil resistance (Ω)	Coil Inductance (H) (ref. value)		Set pick-up voltage	Reset pick-up voltage	Maximum voltage	Power consumption (mW)
			Armature OFF	Armature ON	% of rated voltage			
3	33.3	90	0.108	0.069	75% max.	75% max.	180% max. @ 23°C	Approx. 100
4.5	22.2	203	0.27	0.14				
5	20.0	250	0.36	0.18				
12	8.3	1,440	2.12	1.14				
24	6.3	3,840	5.80	3.79				Approx. 150

G6SK - Standard Dual Coil Latching (G6SK-2F, G6SK-2G, G6SK-2)

Rated voltage (VDC)	Rated current (mA)	Coil resistance (Ω)	Coil Inductance (H) (ref. value)				Set pick-up voltage	Reset pick-up voltage	Maximum voltage	Power consumption (mW)
			Set		Reset					
			Armature OFF	Armature ON	Armature OFF	Armature ON	% of rated voltage			
3	66.6	45	0.045	0.035	0.032	0.045	75% max.	75% max.	170% max. @ 23°C	Approx. 200
4.5	44.4	101	0.12	0.074	0.082	0.14				
5	40	125	0.14	0.088	0.098	0.16				
12	16.7	720	0.60	0.41	0.46	0.54				
24	12.5	1,920	1.98	1.23	1.34	2.23			140% max. @ 23°C	Approx. 300

G6S - European Version, Non-latching (G6S-2F-Y, G6S-2G-Y, G6S-2-Y)

Rated voltage (VDC)	Rated current (mA)	Coil resistance (Ω)	Pick-up voltage	Dropout voltage	Maximum voltage	Power consumption (mW)
			% of rated voltage			
5	40.0	125	75% max.	10% min.	170% max. @ 23°C	Approx. 200
12	16.7	720				
24	9.6	2,504				

Note: 1. The rated current and coil resistance are measured at a coil temperature of 23°C with a tolerance of ±10%.

2. The operating characteristics are measured at a coil temperature of 23°C.

3. Pick-up voltage will vary with temperature.

4. The maximum voltage is the highest voltage that can be imposed on the relay coil.

■ Characteristics

Contact resistance (See note 1)		75 mΩ max.
Operate (set) time (See note 2)		4 ms max. (mean value approx. 2.5 ms G6S; 2.0 ms G6SU, G6SK)
Release (reset) time (See note 2)		4 ms max. (mean value approx. 1.5 ms G6S; 2.0 ms G6SU, G6SK)
Bounce time		Approx. 0.5 ms
Max. operating frequency		Mechanical: 36,000 operations/hr Electrical: 1,800 operations/hr (under rated load)
Insulation resistance (See note 3)		1,000 MΩ min. (at 500 VDC)
Dielectric strength		2,000 VAC, 50/60 Hz for 1 minute (G6S, G6SU) between coil and contacts 1,000 VAC, 50/60 Hz for 1 minute (G6SK) between coil and contacts 1,500 VAC, 50/60 Hz for 1 minute between contacts of different poles 1,000 VAC, 50/60 Hz for 1 minute between contacts of same pole 500 VAC, 50/60 Hz for 1 minute between set and reset coils (G6SK)
Surge withstand voltage	Conforming to Telcordia specs.	2,500 V (2 x 10 μS) between coil and contacts for G6S and G6SU 2,500 V (2 x 10 μS) between contacts of different poles
	Conforming to FCC Part 68	1,500 V (10 x 160 μS) between coil and contacts for G6SK 1,500 V (10 x 160 μS) between contacts of same pole
Vibration	Mechanical durability	10 to 55 Hz; 5 mm double amplitude
	Malfunction durability	10 to 55 Hz; 3.3 mm double amplitude
Shock	Mechanical durability	1,000 m/s ² ; approx. 100 G
	Malfunction durability	750 m/s ² ; approx. 75 G
Ambient temperature		-40 to +85°C with no icing; -40 to +70°C with no icing (G6SK, DC24 coil)
Ambient Humidity		5% to 85% RH
Service life	Mechanical	100,000,000 operations min. (at 36,000 operations/hour)
	Electrical	100,000 operations min. (2A@30VDC, resistive; 1,200 ops/hr.) 100,000 operations min. (0.5A@125VAC, resistive) See "Characteristic Data"
Weight		Approx. 2g

- Note:**
1. The contact resistance was measured with 10 mA at 1 VDC with a voltage drop method.
 2. Values in parentheses are typical values unless otherwise stated.
 3. The insulation resistance was measured with a 500-VDC megohmmeter applied to the same parts as those used for checking the dielectric strength (except between the set and reset coil).
 4. Data shown are of initial value.

■ Characteristic Data

Service Life

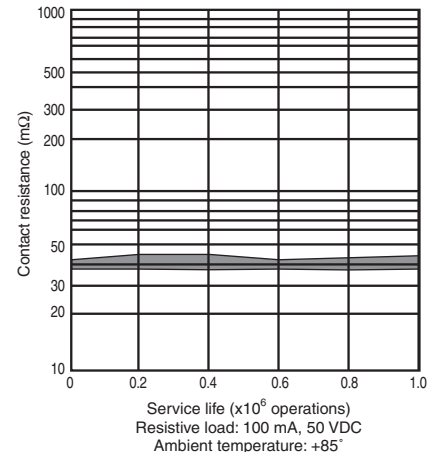
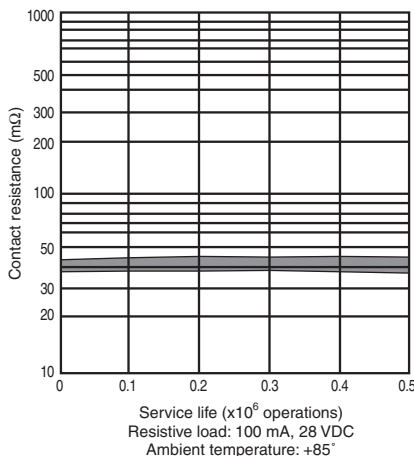
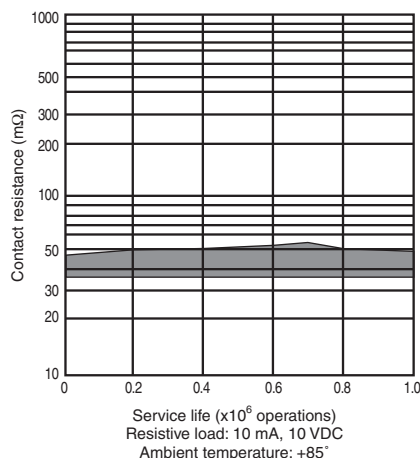

Maximum Switching Capacity

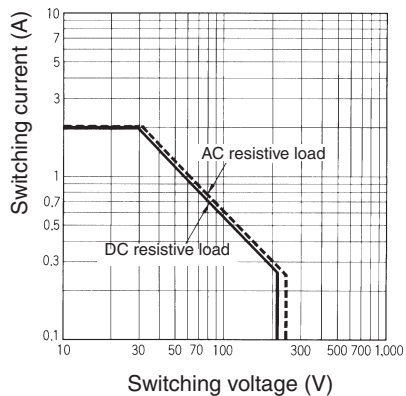

Ambient Temperature vs. Maximum Coil Voltage Non-latching

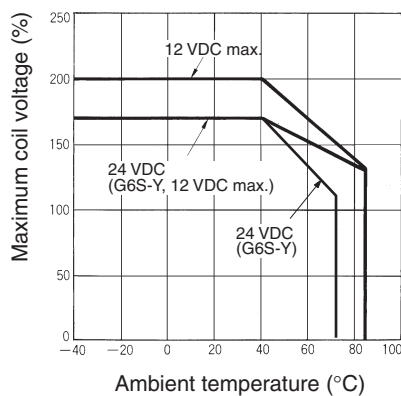

Single Coil Latching Dual Coil Latching

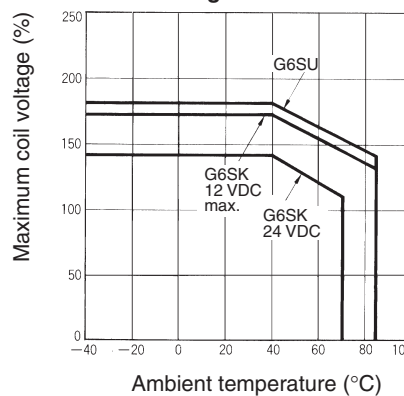

Note: The maximum coil voltage refers to the maximum value in a varying range of operating power voltage, not a continuous voltage.

Reference Data

Ambient Temperature vs. Switching Current Non-latching

Non-latching

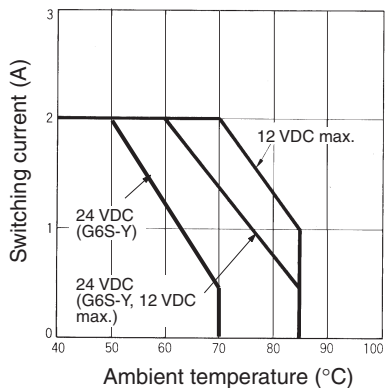

Single Coil Latching Dual Coil Latching

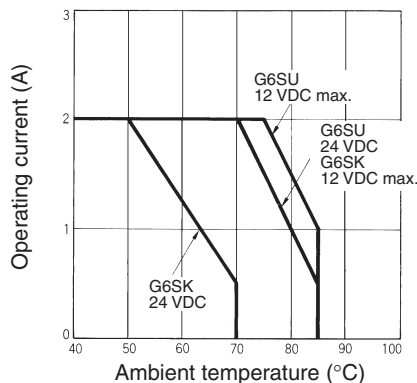

Electrical Service Life

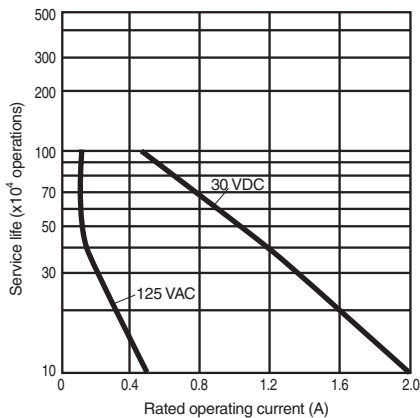

Dielectric Strength (Standard Version, Non-latching)

Detecting current: 1mA

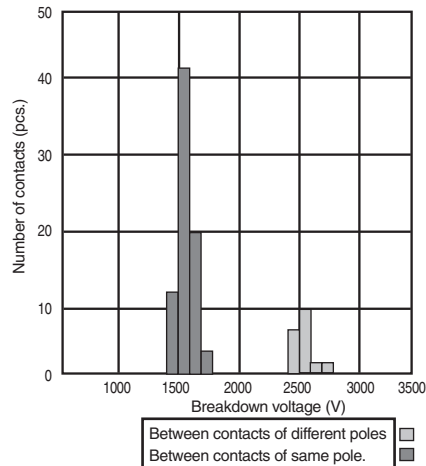
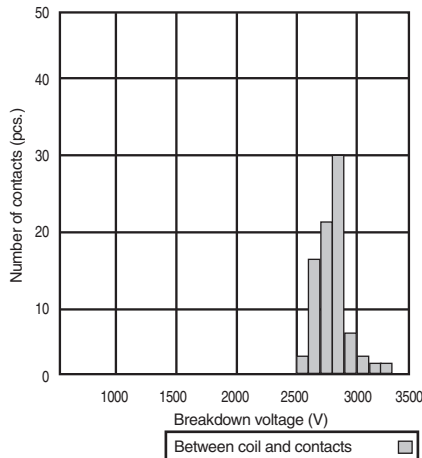

Impulse Withstand Voltage (Standard Version, Non-latching)

(2 x 10 μs)

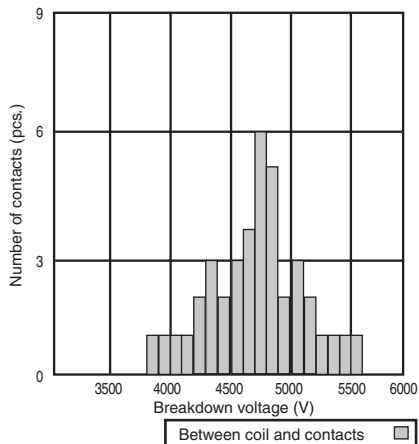

(10 x 160 μs)

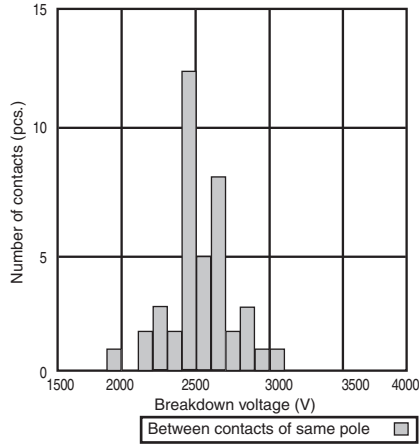

(10 x 160 μs)

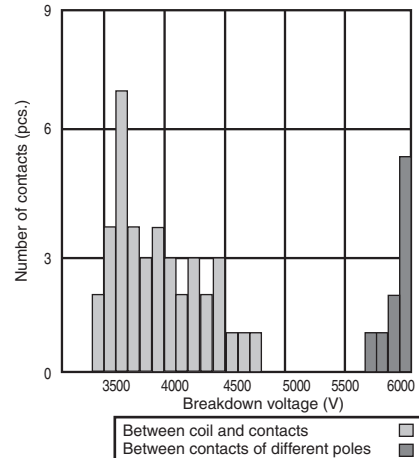

Impulse Withstand Voltage (European version)

(2 x 10 μs)

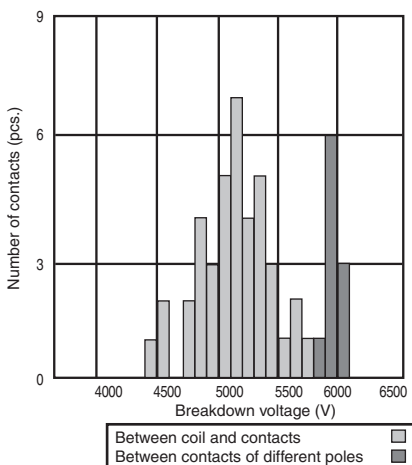

(10 x 160 μs)

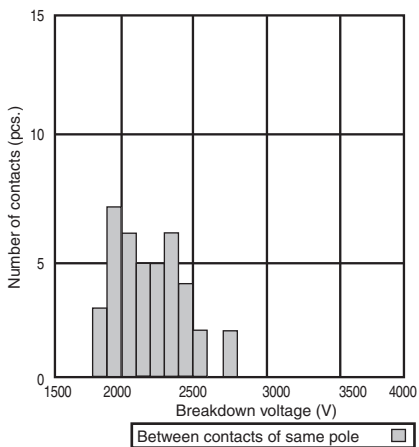

(10 x 160 μs)

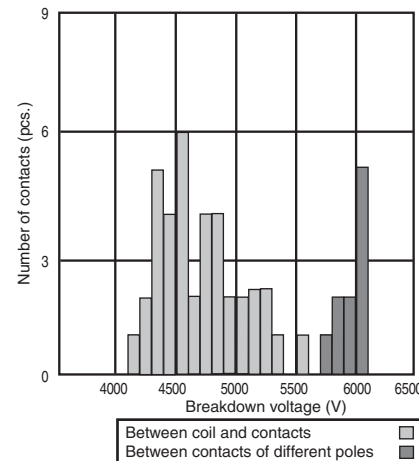

Dielectric Strength (European Version, Non-latching)

Detecting current: 1mA

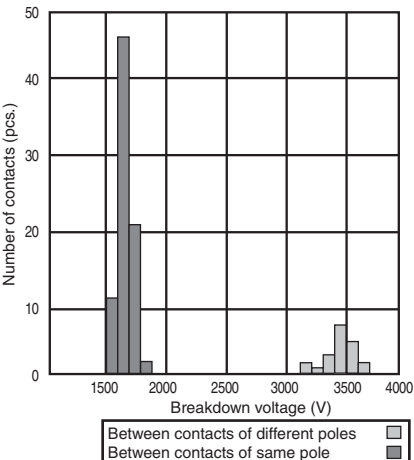
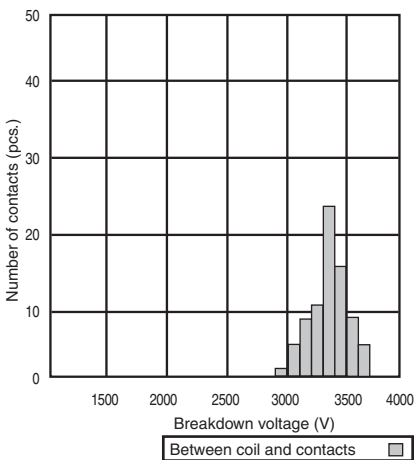

Dimensions

Note: 1. All units are in millimeters unless otherwise indicated.
 2. Coplanarity is 0.1 mm max.

Standard

G6S-2F, G6S-2F-Y

Tolerance: ± 0.3

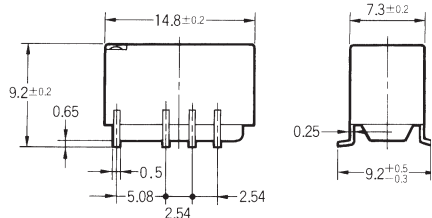
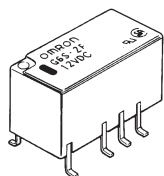

Terminal Arrangement/ Internal Connections (Top View)

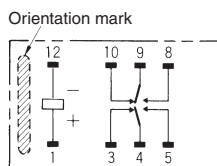

Footprint (Top View)

Tolerance: ± 0.1

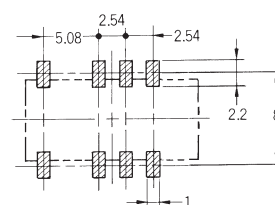

G6S-2G, G6S-2G-Y

Tolerance: ± 0.3

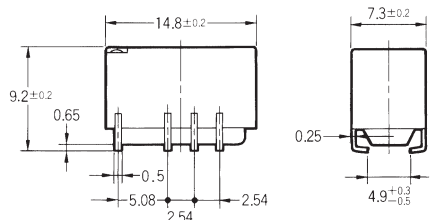
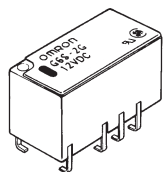

Terminal Arrangement/ Internal Connections (Top View)

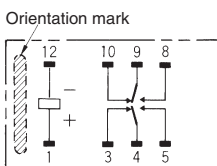

Footprint (Top View)

Tolerance: ± 0.1

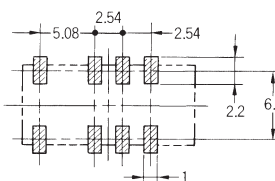

G6S-2, G6S-2-Y

Tolerance: ± 0.3

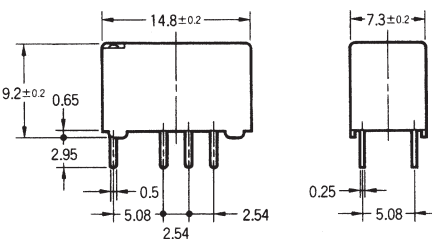
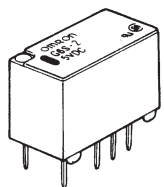

Terminal Arrangement/ Internal Connections (Bottom View)

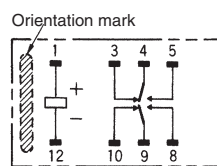

Footprint (Bottom View)

Tolerance: ± 0.1

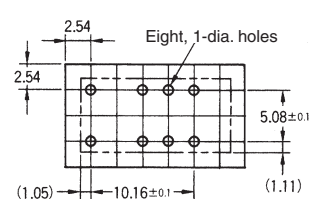

Single Coil Latching

G6SU-2F

Tolerance: ± 0.3

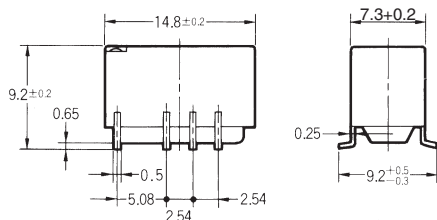
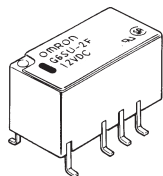

Terminal Arrangement/
Internal Connections
(Top View)

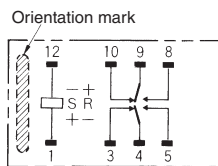

Footprint
(Top View)

Tolerance: ± 0.1

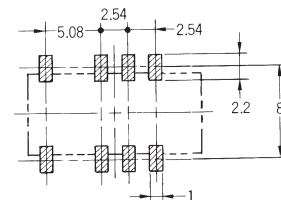

G6SU-2G

Tolerance: ± 0.3

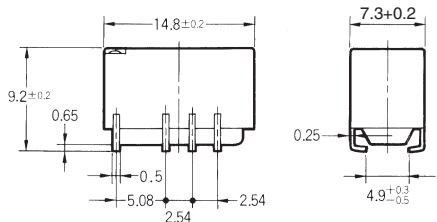
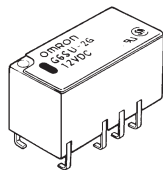

Terminal Arrangement/
Internal Connections
(Top View)

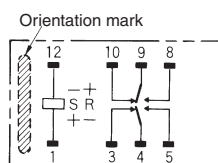

Footprint
(Top View)

Tolerance: ± 0.1

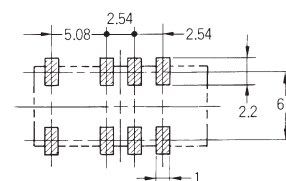

G6SU-2

Tolerance: ± 0.3

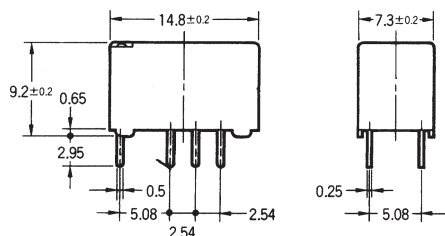
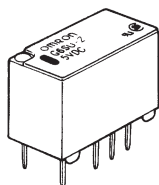

Terminal Arrangement/
Internal Connections
(Bottom View)

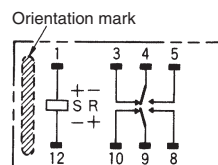

Footprint
(Bottom View)

Tolerance: ± 0.1

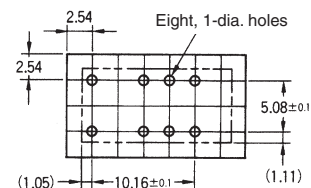

Dual Coil Latching

G6SK-2F

Tolerance: ± 0.3

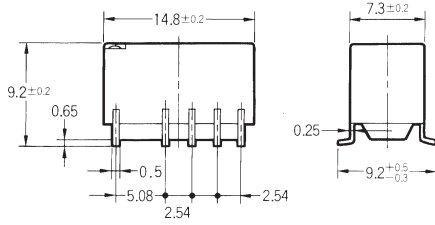
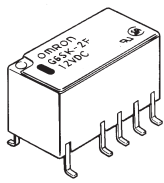

Terminal Arrangement/ Internal Connections (Top View)

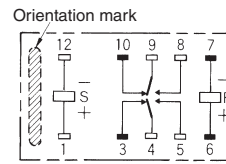

Footprint (Top View)

Tolerance: ± 0.1

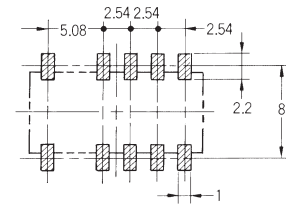

G6SK-2G

Tolerance: ± 0.3

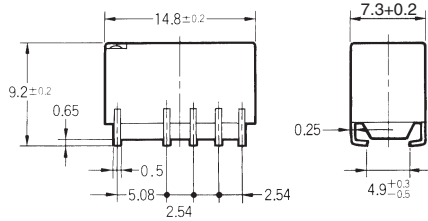
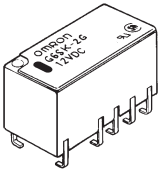

Terminal Arrangement/ Internal Connections (Top View)

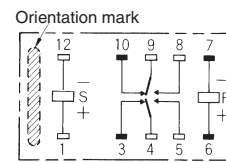

Footprint (Top View)

Tolerance: ± 0.1

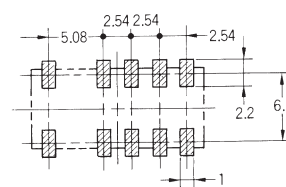

G6SK-2

Tolerance: ± 0.3

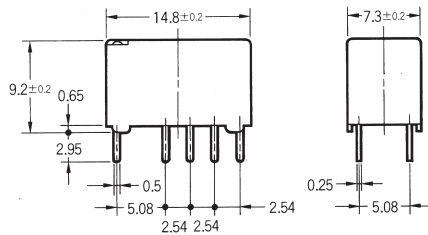
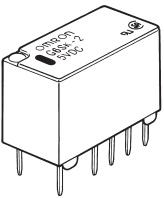

Terminal Arrangement/ Internal Connections (Bottom View)

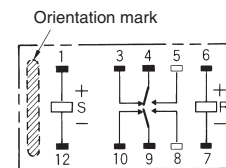

Footprint (Bottom View)

Tolerance: ± 0.1

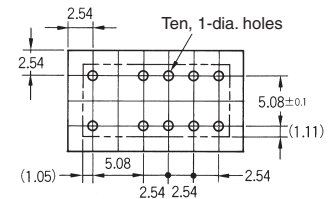

Recommended Soldering Method

(1) IRS Method (Mounting Solder: Lead)

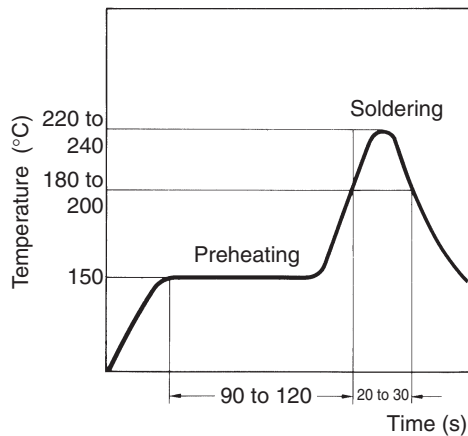

(2) IRS Method (Mounting Solder: Lead-free)

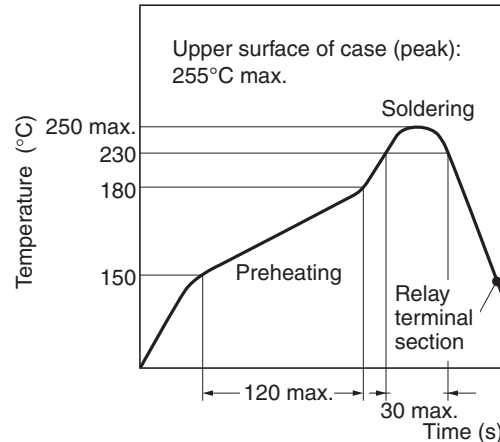

Note: The temperature profile indicates the temperature on the PCB.

Packaging

Tube packing	Standard nomenclature	50 pcs per anti-static tube
Tape packing (Surface mount versions)	When ordering, add "TR" before the rated coil voltage (e.g., G6S-2F-TR-DC12) Note: TR is not part of the relay model number and will not be marked on the relay.	

■ Tape and Reel Dimensions (Surface Mount Models)

- Tape type: TE2416R (Refer to EIAJ - Electronic Industrial Association of Japan)
- Reel type: R24E (Refer to EIAJ - Electronic Industrial Association of Japan)
- Relays per reel: 400
- Reels per packing carton: 2 (800 relays)

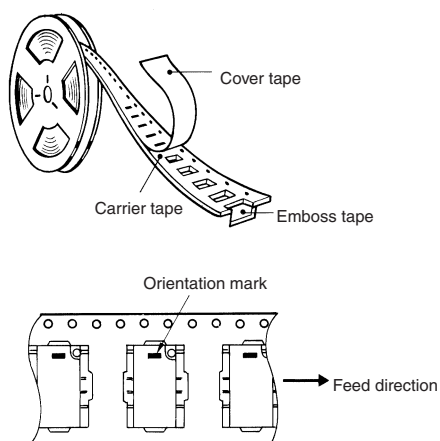
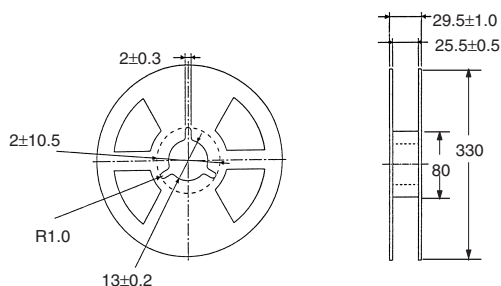

G6S-2F, G6SU-2F, G6SK-2F, G6S-2F-Y

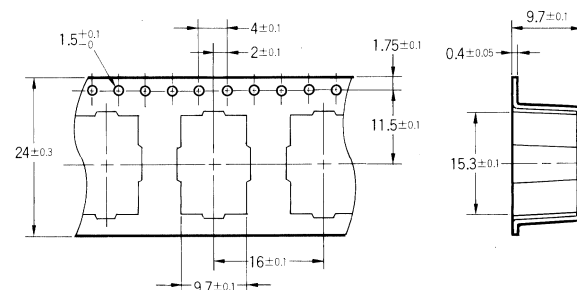

G6S-2G, G6SU-2G, G6SK-2G, G6S-2G-Y

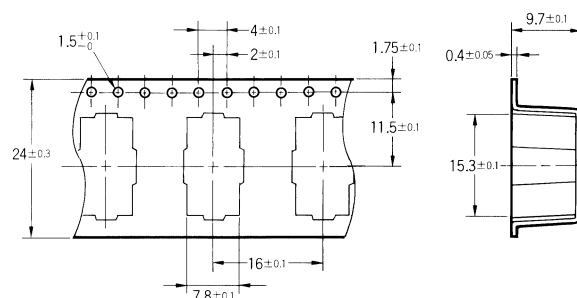

■ Approvals

UL Recognized (File No. E41515) / CSA Certified (File No. LR31928) - - Ambient Temp. = 40°C

Type	Contact form	Coil rating	Contact ratings	Number of test operations
G6S-2, G6S-2F, G6S-2G	DPDT	2 to 48 VDC	3 A at 30 VDC (Resistive)	6,000
G6SU-2, G6SU-2F, G6SU-2G		2 to 24 VDC	0.3 A at 110 VDC (Resistive)	
G6SK-2, G6SK-2F, G6SK-2G			0.5 A at 125 VAC (General Use)	
G6SK-2-Y, G6SK-2F-Y, G6SK-2G-Y				

EN60950 / EN41003

Type	Contact form	Isolation Category	Voltage
G6S-2-Y, G6S-2F-Y, G6S-2G-Y	DPDT	Supplementary Isolation	250 VAC

- Note:**
1. The rated values approved by each of the safety standards (e.g., UL and CSA) may be different from the performance characteristics individually defined in this catalog.
 2. In the interest of product improvement, specifications are subject to change.

Precautions

- Use a DC power supply with 5% or less ripple factor to operate the coil.
- Do not use the G6S where subject to strong external magnetic fields.
- Do not use the G6S where subject to magnetic particles or excessive amounts of dust.
- Do not reverse the polarity of the coil (+, -).

Correct use

Long-term Continuously ON Contacts

Using the Relay in a circuit where the Relay will be ON continuously for long periods (without switching) can lead to unstable contacts because the heat generated by the coil itself will affect the insulation, causing a film to develop on the contact surfaces. We recommend using a latching relay (magnetic-holding relay) in this kind of circuit. If a single-side stable model must be used in this kind of circuit, we recommend using a fail-safe circuit design that provides protection against contact failure or coil burnout.

Relay Handling

Use the Relay as soon as possible after opening the moisture-proof package. If the Relay is left for a long time after opening the moisture-proof package, the appearance may suffer and seal failure may occur after the solder mounting process. To store the Relay after opening the moisture-proof package, place it into the original package and sealed the package with adhesive tape.

When washing the product after soldering the Relay to a PCB, use a water-based solvent or alcohol-based solvent, and keep the solvent temperature to less than 40°C. Do not put the Relay in a cold cleaning bath immediately after soldering.

Claw Securing Force During Automatic Mounting

During automatic insertion of Relays, be sure to set the securing force of each claw to the following so that the Relay's characteristics will be maintained.

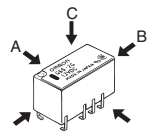

Dimension A: 1.96 N max.
 Dimension B: 4.90 N max.
 Dimension C: 1.96 N max.

- Latching types are delivered in the reset position. We recommend that a reset voltage be applied in advance to start operation.
- Do not drop the G6S or otherwise subject it to excessive shock.
- Remove the relay from the packing immediately prior to usage.

G6S (K) (-U) -2 Soldering

- Soldering temperature: Approx. 250°C (At 260°C if the DWS method is used.)
- Soldering time: Approx. 5 s max. (Approx. 2 s for the first time and approx. 3 s for the second time if the DWS method is used.)
- Be sure to adjust the level of the molten solder so that the solder will not overflow onto the PCB.

G6S (K) (-U) -2F Soldering

The thickness of cream solder to be applied should be within a range between 150 μm and 200 μm on Omron's recommended PCB pattern.

In order to perform correct soldering, it is recommended that the correct soldering conditions be maintained as shown below on the left side.

Correct Soldering

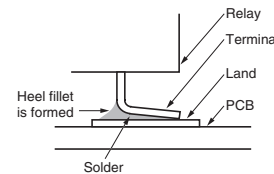

Incorrect Soldering

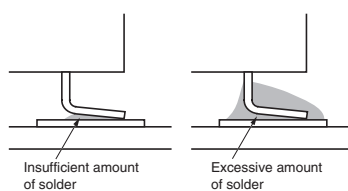

Visually check that the relay is properly soldered.



All sales are subject to Omron Electronic Components LLC standard terms and conditions of sale, which can be found at http://www.components.omron.com/components/web/webfiles.nsf/sales_terms.html

ALL DIMENSIONS SHOWN ARE IN MILLIMETERS.

To convert millimeters into inches, multiply by 0.03937. To convert grams into ounces, multiply by 0.03527.

OMRON[®]

**OMRON ELECTRONIC
COMPONENTS LLC**

55 E. Commerce Drive, Suite B
Schaumburg, IL 60173

847-882-2288

OMRON ON-LINE

Global - <http://www.omron.com>

USA - <http://www.components.omron.com>