

# G3VM-□WR

MOS FET Relays

P-SON 4-pin, High-Current and Low-ON-Resistance Type

## New Non-Leaded, High-Current P-SON Package

- Load voltage 30 V/60 V/100 V.
- 30 V relay: Continuous load current of 4.5 A max.
- 60 V relay: Continuous load current of 3 A max.
- 100 V relay: Continuous load current of 2 A max.
- High Ambient operating temperature: -40°C to +110°C

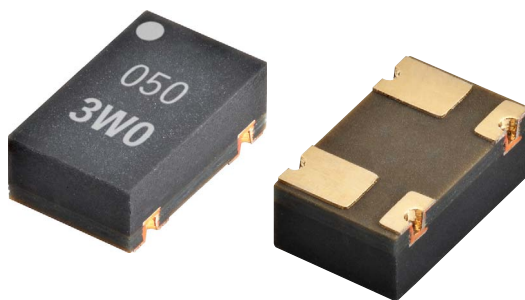

Note: The actual product is marked differently from the image shown above.

RoHS Compliant

### Application Examples

- Semiconductor test equipment
- Test & measurement equipment
- Communication equipment
- Data loggers

### Package (Unit : mm, average)

P-SON 4-pin

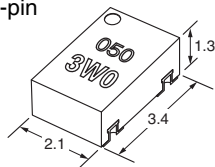

Note: The actual product is marked differently from the image shown above.

### Model Number Legend

G3VM-□□□□  
1 2 3 4

#### 1. Load voltage

- 3: 30 V
- 6: 60 V
- 10: 100 V

#### 2. Contact form

- 1: 1a (SPST-NO)

#### 3. Package type

- W: P-SON 4-pin

#### 4. Additional functions

- R: Low on-resistance

### Ordering Information

Package type	Contact form	Terminals	Load voltage (peak value) *	Continuous load current (peak value) *	Packing/Tape cut		Packing/Tape & reel	
					Model	Minimum package quantity	Model	Minimum package quantity
P-SON4	1a (SPST-NO)	Surface-mounting Terminals	30 V	4.5 A	G3VM-31WR	1 pc.	G3VM-31WR (TR05)	500 pcs.
			60 V	3 A	G3VM-61WR		G3VM-61WR (TR05)	
			100 V	2 A	G3VM-101WR		G3VM-101WR (TR05)	

\* The AC peak and DC value are given for the load voltage and continuous load current.

Note: When ordering tape packing, add "(TR05)" (500 pcs/reel) to the model number.

Ask your OMRON representative for orders under 500 pcs. We can supply products with the tape already cut.

Tape-cut P-SON is packaged without humidity resistance. Use manual soldering to mount them.

Refer to common precautions.

G3VM-□WR

P-SON

## Absolute Maximum Ratings (Ta = 25°C)

Item		Symbol	G3VM-31WR	G3VM-61WR	G3VM-101WR	Unit	Measurement conditions
Input	LED forward current	IF	30			mA	
	LED forward current reduction rate	ΔIF/°C	-0.3			mA/°C	Ta≥25°C
	LED reverse voltage	VR	6			V	
	Connection temperature	TJ	125			°C	
Output	Load voltage (AC peak/DC)	V <sub>OFF</sub>	30	60	100	V	
	Continuous load current (AC peak/DC)	Io	4.5	3	2	A	
	ON current reduction rate	ΔIo/°C	-45	-30	-20	mA/°C	Ta≥25°C
	Pulse ON current	I <sub>op</sub>	10	9	6	A	t=100 ms, Duty=1/10
	Connection temperature	TJ	125			°C	
Dielectric strength between I/O *		V <sub>I-O</sub>	500			V <sub>rms</sub>	AC for 1 min
Ambient operating temperature		Ta	-40 to +110			°C	With no icing or condensation
Ambient storage temperature		T <sub>stg</sub>	-40 to +125			°C	
Soldering temperature		-	260			°C	10 s

\* The dielectric strength between the input and output was checked by applying voltage between all pins as a group on the LED side and all pins as a group on the light-receiving side.

## Electrical Characteristics (Ta = 25°C)

Item		Symbol	G3VM-31WR	G3VM-61WR	G3VM-101WR	Unit	Measurement conditions
Input	LED forward voltage	Minimum	1.1			V	I <sub>F</sub> =10 mA
		Typical	1.22	1.22	1.22		
		Maximum	1.4				
	Reverse current	I <sub>R</sub>	10			μA	V <sub>R</sub> =5 V
	Capacity between terminals	C <sub>T</sub>	70			pF	V=0, f=1 MHz
	Trigger LED forward current	Typical	1		0.9	mA	I <sub>o</sub> =1 A
Maximum		3					
Release LED forward current	Minimum	0.1			mA	I <sub>OFF</sub> =10 μA	
	Typical	0.9		0.8			
Maximum resistance with output ON	Typical	25	45	130	mΩ	I <sub>o</sub> =Continuous load current rated value I <sub>F</sub> =5 mA, t<1 s	
	Maximum	50	100	200			
Current leakage when the relay is open	I <sub>LEAK</sub>	Maximum	1000 (10)			nA	V <sub>OFF</sub> = Load voltage rated value 31WR : (V <sub>OFF</sub> =20 V) 61WR : (V <sub>OFF</sub> =40 V) 101WR : (V <sub>OFF</sub> =80 V)
			Capacity between terminals	C <sub>off</sub>	450		
Capacity between I/O terminals		C <sub>I-O</sub>	1			pF	f=1 MHz, V <sub>S</sub> =0 V
Insulation resistance between I/O terminals		R <sub>I-O</sub>	10 <sup>8</sup>			MΩ	V <sub>I-O</sub> =500 VDC, R <sub>oH</sub> ≤60%
Turn-ON time	t <sub>ON</sub>	Typical	3		2	ms	I <sub>F</sub> =5 mA, R <sub>L</sub> =200 Ω, V <sub>DD</sub> =10 V (G3VM-31WR) V <sub>DD</sub> =20 V (G3VM-61WR/101WR) *
		Maximum	5		3		
Turn-OFF time	t <sub>OFF</sub>	Typical	0.04		0.03		
		Maximum	1				

\* Turn-ON and Turn-OFF Times

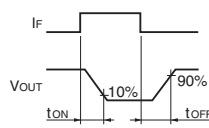
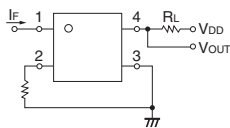

## Recommended Operating Conditions

For high reliability usage, Recommended Operation Conditions are measures that take into account the derating of Absolute Maximum Ratings and Electrical Characteristics.

Each item on this list is an independent condition, so it is not simultaneously satisfying several conditions.

Item	Symbol	G3VM-31WR	G3VM-61WR	G3VM-101WR	Unit
Load voltage (AC peak/DC)	V <sub>DD</sub>	Maximum 24	48	80	V
Operating LED forward current	I <sub>F</sub>	Typical	5		mA
		Maximum	20		
Continuous load current (AC peak/DC)	I <sub>o</sub>	Maximum 4.5	3	2	A
Ambient operating temperature	Ta	Minimum	-20		°C
		Maximum	85		

## Engineering Data

● LED forward current vs. ambient temperature

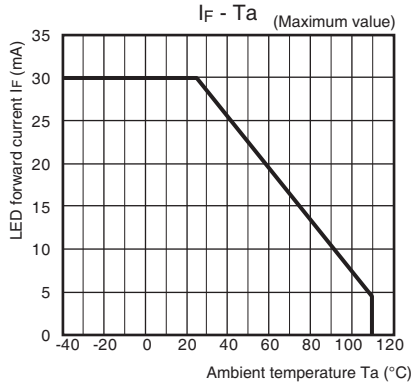

● Continuous load current vs. ambient temperature

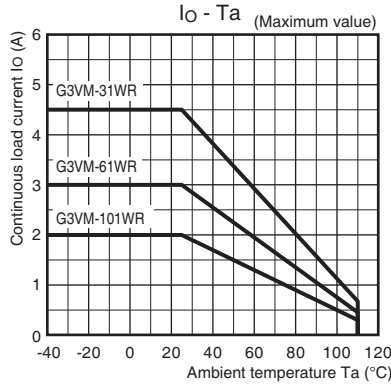

● LED forward current vs. LED forward voltage

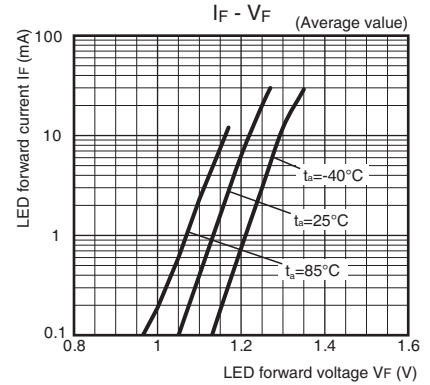

● Continuous load current vs. on-state voltage

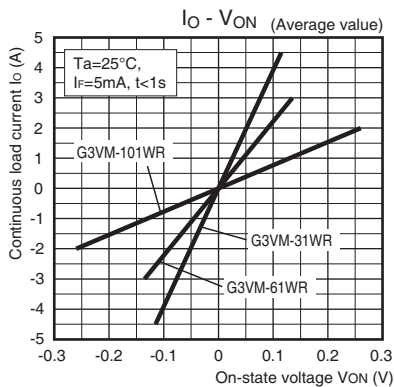

● On-state resistance vs. ambient temperature

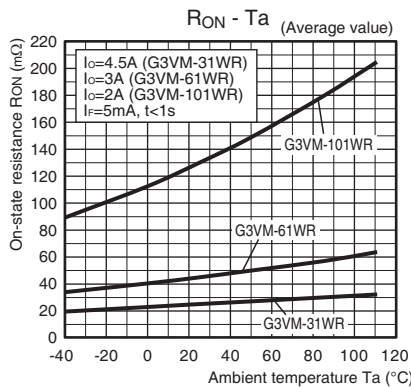

● Trigger LED forward current vs. ambient temperature

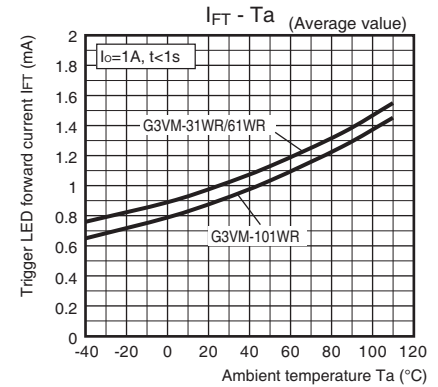

● Turn ON, turn OFF time vs. LED forward current

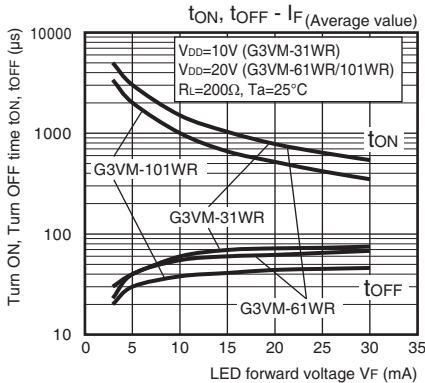

● Turn ON, turn OFF time vs. ambient temperature

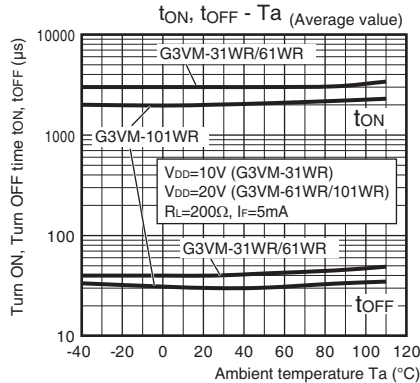

● Current leakage vs. load voltage

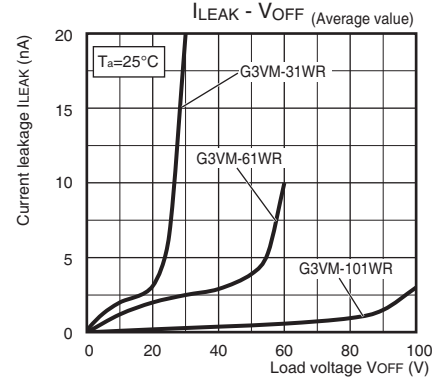

● Current leakage vs. ambient temperature

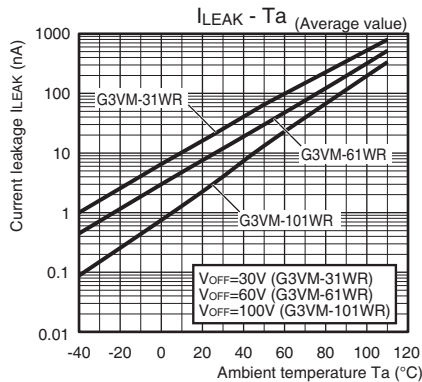

● Output terminal capacitance vs. load voltage

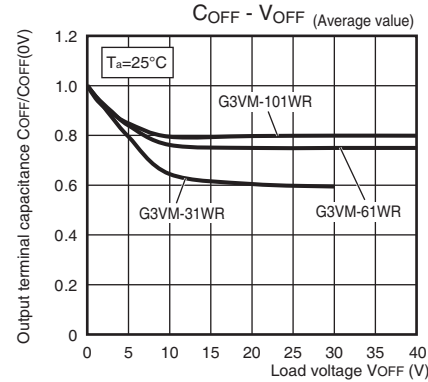

## ■Appearance / Terminal Arrangement / Internal Connections

### ■Appearance

P-SON (Power - Small Outline Non-Leaded)  
P-SON 4-pin

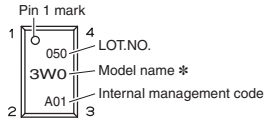

\* Actual model name marking for each model

Model	Marking
G3VM-31WR	3W0
G3VM-61WR	6W0
G3VM-101WR	AW0

### ■Terminal Arrangement/Internal Connections (Top View)

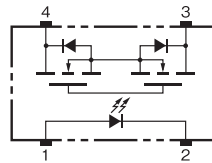

**Note** 1. The actual product is marked differently from the image shown above.  
2. "G3VM" does not appear in the model number on the relay.

### ■Dimensions (Unit: mm)

#### Surface-Mounting Terminals

Weight: 0.02 g

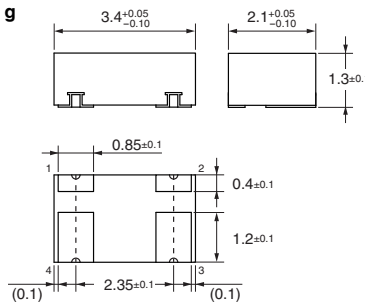
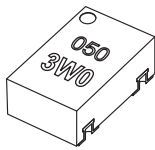

#### Actual Mounting Pad Dimensions

(Recommended Value, Top View)

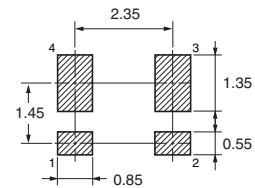

Unless otherwise specified, the dimensional tolerance is ± 0.1 mm.

**Note:** The actual product is marked differently from the image shown here.

### ■Safety Precautions

- Refer to "Common Precautions" for all G3VM models.

Please check each region's Terms & Conditions by region website.

**OMRON Corporation**  
Electronic and Mechanical Components Company

#### Regional Contact

**Americas**  
<https://www.components.omron.com/>  
**Asia-Pacific**  
<https://ecb.omron.com.sg/>  
**Korea**  
<https://www.omron-ecb.co.kr/>

**Europe**  
<http://components.omron.eu/>  
**China**  
<https://www.ecb.omron.com.cn/>  
**Japan**  
<https://www.omron.co.jp/ecb/>

© OMRON Corporation 2020 All Rights Reserved.  
In the interest of product improvement, specifications are subject to change without notice.

Cat. No. K334-E1-02  
1220(1020)(O)