

MOS FET Relays

G3VM-353H/H1

Analog-switching MOS FET Relay with SPST-NC (Double-pole, Single-throw, Normally Closed) Contacts General-purpose Series Added

- New models with SPST-NC contacts and a 6-pin SOP package now included in 350-V load voltage series.
- Continuous load current of 120 mA (90 mA).
- Dielectric strength of 1,500 Vrms between I/O.
- General-purpose series (high ON-resistance) added.

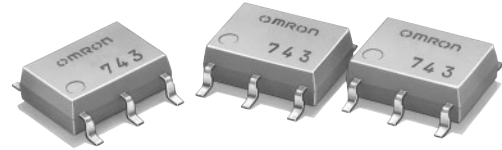

NEW

Note: The actual product is marked differently from the image shown here.

Caution

Refer to "Common Precautions" on page 2.

Application Examples

- Broadband systems
- Measurement devices
- Data loggers
- Amusement machines

List of Models

Contact form	Terminals	Load voltage (peak value)	Model	Minimum packaging unit	
				Number per stick	Number per tape
SPST-NC	Surface-mounting terminals	350 V AC	G3VM-353H	75	---
			G3VM-353H1		
			G3VM-353H(TR)	---	2,500
			G3VM-353H1(TR)		

Dimensions

Note: All units are in millimeters unless otherwise indicated.

G3VM-353H/H1

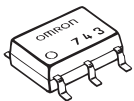

Note: The actual product is marked differently from the image shown here.

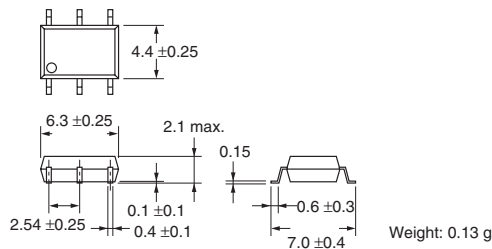

Terminal Arrangement/Internal Connections (Top View)

G3VM-353H/H1

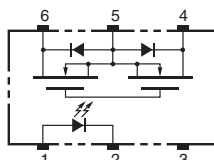

Actual Mounting Pad Dimensions (Recommended Value, Top View)

G3VM-353H/H1

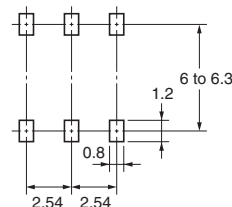

Absolute Maximum Ratings (Ta = 25°C)

Item	Symbol	Rating	Unit	Measurement Conditions		
Input	LED forward current	I_F	50	mA		
	Repetitive peak LED forward current	I_{FP}	1	A	100 μ s pulses, 100 pps	
	LED forward current reduction rate	$\Delta I_F/^\circ\text{C}$	-0.5	mA/°C	Ta \geq 25°C	
	LED reverse voltage	V_R	5	V		
	Connection temperature	T_J	125	°C		
Output	Output dielectric strength	V_{OFF}	350	V		
	Continuous load current	Connection A	I_O	120 (90)	mA	
		Connection B		120 (90)		
		Connection C		240 (180)		
	ON current reduction rate	Connection A	$\Delta I_{ON}/^\circ\text{C}$	-1.2 (-0.9)	mA/°C	Ta \geq 25°C
		Connection B		-1.2 (-0.9)		
Connection C			-2.4 (-1.8)			
Connection temperature	T_J	125	°C			
Dielectric strength between input and output (See note 1.)		$V_{I/O}$	1,500	Vrms	AC for 1 min	
Operating temperature		T_a	-40 to 85	°C	With no icing or condensation	
Storage temperature		T_{stg}	-55 to 125	°C	With no icing or condensation	
Soldering temperature (10 s)		---	260	°C	10 s	

Note 1. The dielectric strength between the input and output was checked by applying voltage between all pins as a group on the LED side and all pins as a group on the light-receiving side.

Connection Diagram

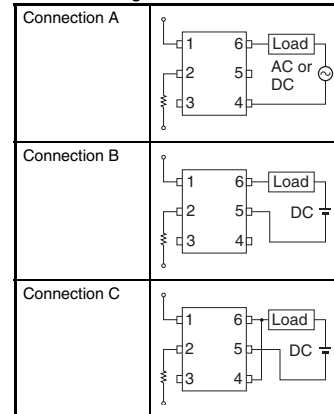

Values inside parentheses () are for G3VM-353H1.

Electrical Characteristics (Ta = 25°C)

Item	Symbol	Minimum	Typical	Maximum	Unit	Measurement conditions		
Input	LED forward voltage	V_F	1.0	1.15	1.3	V	$I_F = 10$ mA	
	Reverse current	I_R	---	---	10	μ A	$V_R = 5$ V	
	Capacity between terminals	C_T	---	30	---	pF	V = 0, f = 1 MHz	
	Trigger LED forward current	I_{FC}	---	1.0	3.0	mA	$I_{OFF} = 10$ μ A	
Output	Maximum resistance with output ON	Connection A	R_{ON}	---	15 (27)	25 (50)	Ω	$I_O = 120$ mA
		Connection B		---	8 (20)	14 (43)	Ω	$I_O = 120$ mA
		Connection C		---	4 (10)	---	Ω	$I_O = 240$ mA
Current leakage when the relay is open	I_{LEAK}	---	---	1.0	μ A	$V_{OFF} = 350$ V, $I_F = 5$ mA		
Capacity between I/O terminals	$C_{I/O}$	---	0.8	---	pF	f = 1 MHz, $V_s = 0$ V		
Insulation resistance	$R_{I/O}$	1,000	---	---	M Ω	$V_{I/O} = 500$ V DC, $R_{OH} \leq 60\%$		
Turn-ON time	tON	---	(0.25)	1.0 (0.5)	ms	$I_F = 5$ mA, $R_L = 200$ Ω , $V_{DD} = 20$ V (See note 2.)		
Turn-OFF time	tOFF	---	(0.5)	3.0 (1)	ms			

Note 2. Turn-ON and Turn-OFF Times

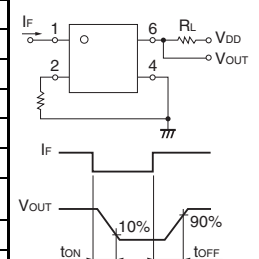

Values inside parentheses () are for G3VM-353H1.

Recommended Operating Conditions

Use the G3VM under the following conditions so that the Relay will operate properly.

Item	Symbol	Minimum	Typical	Maximum	Unit
Output dielectric strength	V_{DD}	---	---	280	V
Operating LED forward current	I_F	5	---	25	mA
Continuous load current	I_O	---	---	120 (90)	mA
Operating temperature	T_a	-20	---	65	°C

Values inside parentheses () are for G3VM-353H1.

Engineering Data

Load Current vs. Ambient Temperature G3VM-353H

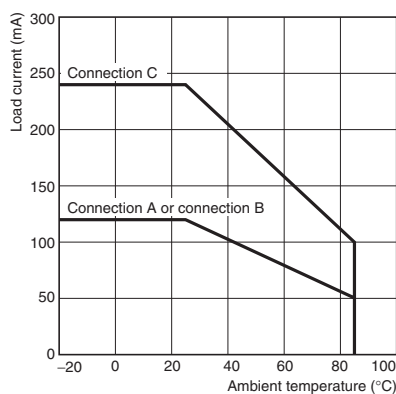

Load Current vs. Ambient Temperature G3VM-353H1

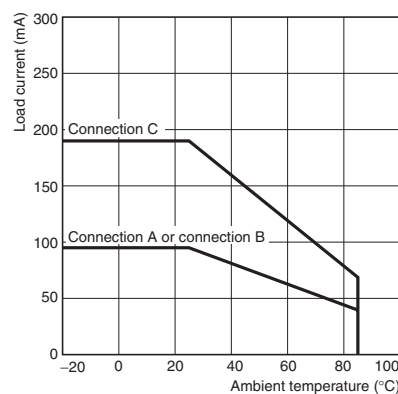

Safety Precautions

Refer to page 2 for precautions common to all G3VM models.