

# G3VM-26M10/26M11/66M

MOS FET Relay Module

## MOS FET Relay in module package with SPDT

- This model of operated by voltage (Rated input voltage is 5 VDC.)
- Contribute to reduce the mounting space on the print circuit board by small package
- Contact form SPDT
- Surface-mounting

RoHS Compliant

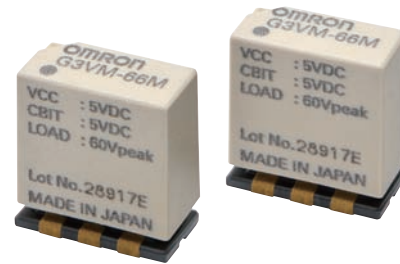

## Application Examples

- Semiconductor test equipment

### Package

(Unit: mm)

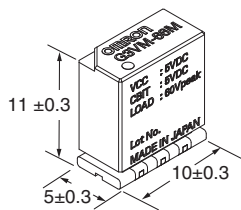

### Model Number Legend

G3VM-□□□□  
1 2 3 4

- |                        |   |                   |                               |
|------------------------|---|-------------------|-------------------------------|
| <b>1. Load Voltage</b> | <b>2. Contact form</b>                                | <b>3. Package</b> | <b>4. Other informations</b>  |
| 2: 20 V                | 6: SPDT   | M: Module         | 10: Low C <sub>OFF</sub> type |
| 6: 60 V                | <b>Note:</b> See Device Function Modes on the page 4. |                   | 11: Low R <sub>ON</sub> type  |

## Ordering Information

Package type	Contact form	Terminals	Rated input voltage		Load voltage (peak value) *	Continuous load current (peak value) *		Model	Minimum package quantity
			V <sub>CC</sub>	V <sub>CBIT</sub>		T <sub>a</sub> =25°C	T <sub>a</sub> =80°C		
Module	SPDT	Surface-mounting Terminals	5 VDC	5 VDC	20 V	200 mA	90 mA	G3VM-26M10	50 pcs/tube
					20 V	1,000 mA	450 mA	G3VM-26M11	
					60 V	400 mA	160 mA	G3VM-66M	

\* The AC peak and DC value are given for the load voltage and continuous load current.

## Absolute maximum rating(Ta=25°C)

Item		Symbol		Rating			Unit	Measurement Conditions
				G3VM-26M10	G3VM-26M11	G3VM-66M		
Input	Rated input voltage	V <sub>CC</sub>	Minimum	4.8			V	I <sub>o</sub> =Continuous load current
			Maximum	5.2			V	
		V <sub>CBIT</sub>	Minimum	4.5			V	
			Maximum	5.5			V	
Output	Load voltage (AC peak/DC)	V <sub>OFF</sub>	20	20	60	V	V <sub>CC</sub> =5V, I <sub>o</sub> =Continuous load current	
	Continuous load current (AC peak/DC)	I <sub>o</sub>	200	1,000	400	mA	V <sub>CC</sub> =5 V	
	Pulse ON current	I <sub>op</sub>	600	3,000	1,200	mA	V <sub>CC</sub> =5 V, t=100 ms, Duty=1/10	
Dielectric strength between input / output terminals		V <sub>I-O</sub>	500			Vrms	50/60 Hz, 1 min	
Ambient storage temperature		T <sub>stg</sub>	-30 to 100			°C	With no icing condensation	
Ambient operating temperature		T <sub>a</sub>	-30 to 80			°C	With no icing condensation	
Ambient operating humidity			45 to 85			%		

## Electrical characteristics(Ta=25°C)

Item		Symbol		Rating			Unit	Measurement conditions
				G3VM-26M10	G3VM-26M11	G3VM-66M		
Input	Input current	I <sub>INPUT</sub>	Typical	7.3			mA	V <sub>CC</sub> =5 V
			Maximum	15				
Output	ON state resistance of output	R <sub>ON</sub>	Typical	4.4	0.21	1	Ω	V <sub>CC</sub> =5V, I <sub>o</sub> =Continuous load current
			Maximum	5	0.25	1.5		
	OFF state Current leakage	I <sub>LEAK</sub>	Maximum	2			nA	V <sub>OFF</sub> =Load voltage
	OFF state capacitance between output terminals	C <sub>OFF</sub>	Typical	1	40	20	pF	V <sub>CC</sub> =0V, V <sub>s</sub> =0V, f=1MHz, t<1s
Maximum			1.4	-	-			
Capacitance between input / output terminals		C <sub>I-O</sub>	Typical	3.5			pF	V <sub>s</sub> =0V, f=1MHz
Insulation resistance between input / output terminals		R <sub>I-O</sub>	Minimum	500			MΩ	V <sub>I-O</sub> =500 VDC
Operate time	t <sub>ON</sub>	Typical	0.05	0.4	0.3	ms	V <sub>CC</sub> =5V, I <sub>o</sub> =Continuous load current V <sub>OFF</sub> =Load voltage *	
		Maximum	0.3	2.5	1			
Release time	t <sub>OFF</sub>	Typical	0.02	0.04	0.1	ms		
		Maximum	0.3	1.5	1			

\* Both of the output circuits; NO side and NC side may turn ON at the same time for only a moment within the specifications.

## Engineering Data

### ● Input current vs. Ambient temperature

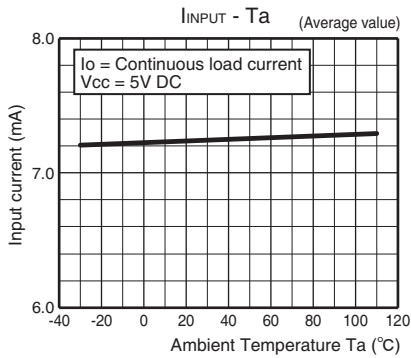

### ● Continuous load current vs. Ambient Temperature

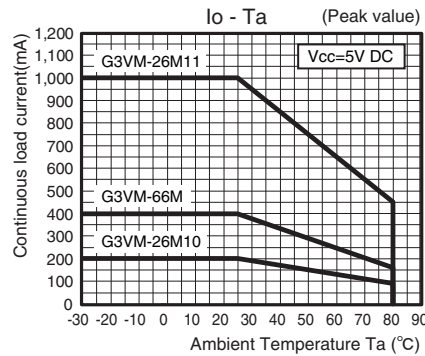

### ● Output terminal capacitance vs. Load voltage

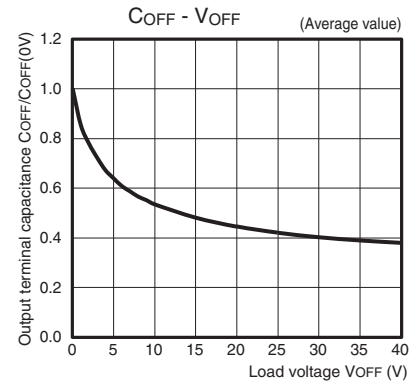

### ● On-state resistance vs. Ambient temperature

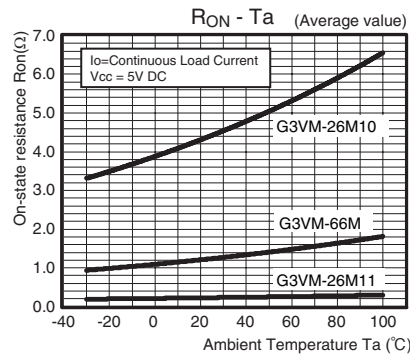

### ● Current leakage vs. Ambient temperature

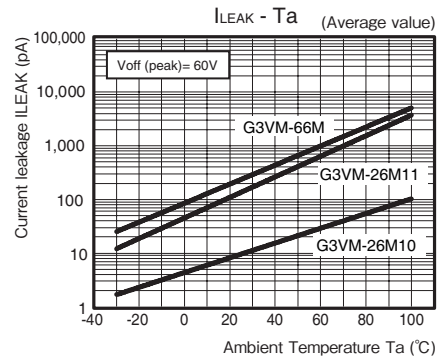

### G3VM-26M11

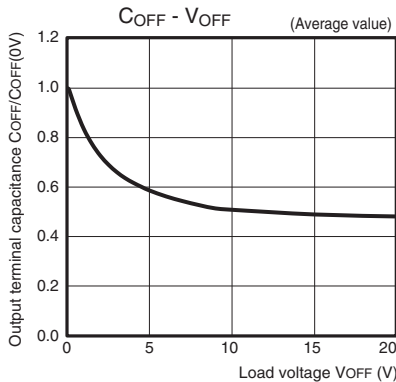

### ● High-frequency Characteristics (Isolation) \*1, \*2

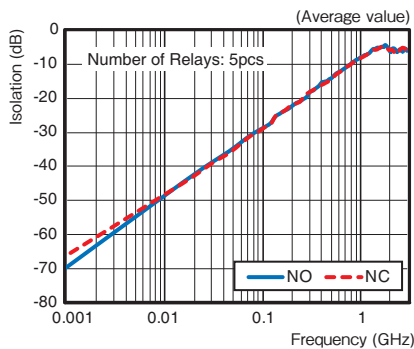

### G3VM-26M11

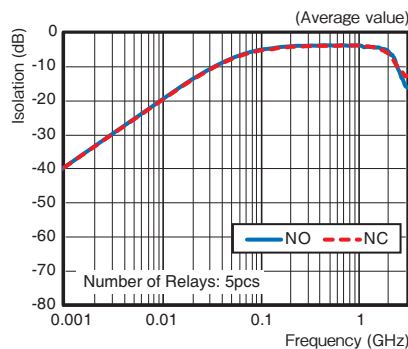

### G3VM-66M

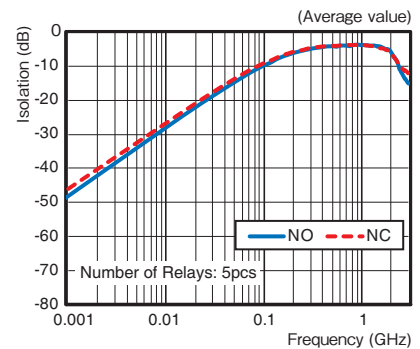

### ● High-frequency Characteristics (Insertion Loss) \*1, \*2

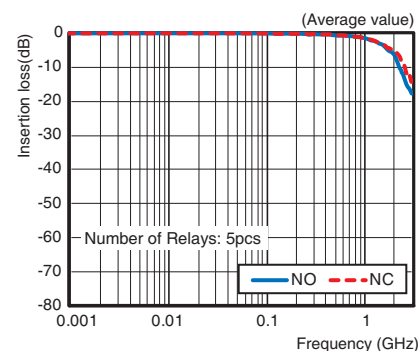

### G3VM-26M11

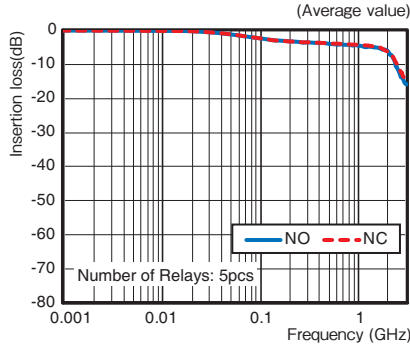

### G3VM-66M

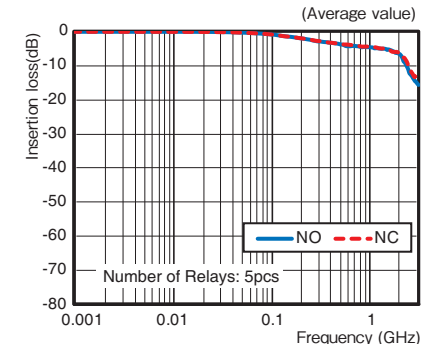

\*1. Ambient temperature condition: 23°C

\*2. The high-frequency characteristics depend on the mounting board. Be sure to check operation including durability in actual equipment before use.

### ●Device Functional Modes \*

INPUT		C BIT	LOAD	
PIN1	PIN2	PIN3	PIN4-5	PIN6-5
H	L	H	ON	OFF
H	L	L	OFF	ON
L	L	X	OFF	OFF

\* H: 5 V, L: 0 V, X: don't care

### ●Timing Diagram

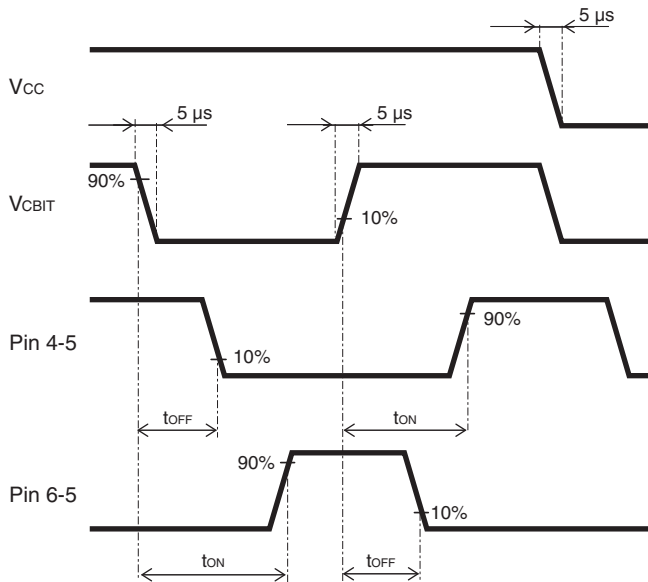

**Note:** If the input voltage is applied with sweeping condition to the MOS FET Relay, both of the output circuits; NO side and NC side will turn ON at the same time.

The rise time of the input voltage must be 5 micro seconds or less, otherwise malfunction or failure may occur.

### ●Measurement Circuit

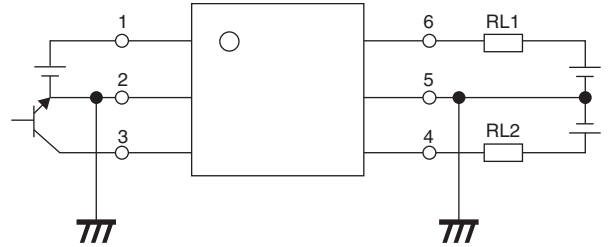

**Note:** The number from 1 to 6 are the pin numbers in the image shown here.

## Appearance / Terminal Arrangement / Internal Connections

### ●Appearance

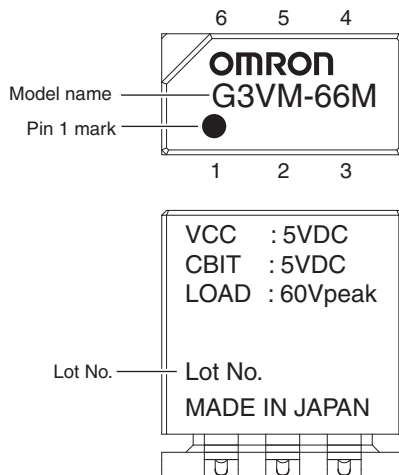

### ●Actual Mounting Pad Dimensions (TOP VIEW)

No input voltage between Vcc-Gnd

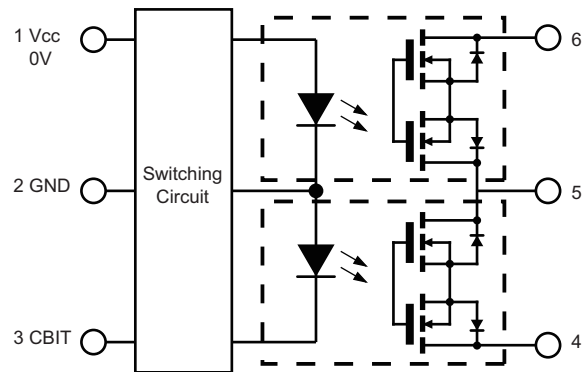

### ●Actual Mounting Pad Dimensions (TOP VIEW)

Input voltage between Vcc-Gnd

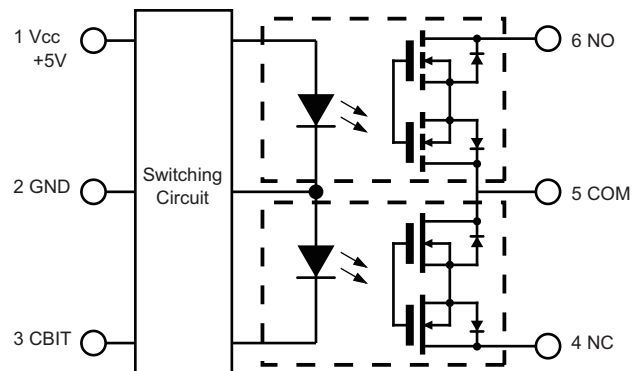

The condition of "NO/NC" in this Terminal Arrangement/Internal Connections (Top View) Input 5V DC between Vcc-Gnd. Please refer to Timing Diagram on the page 4 for more detail.

## Dimensions (Unit: mm)

### Surface-mounting Terminals

Weight: 1 g

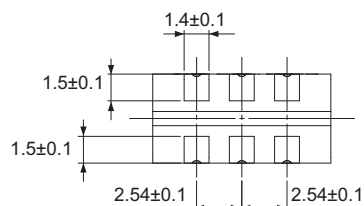
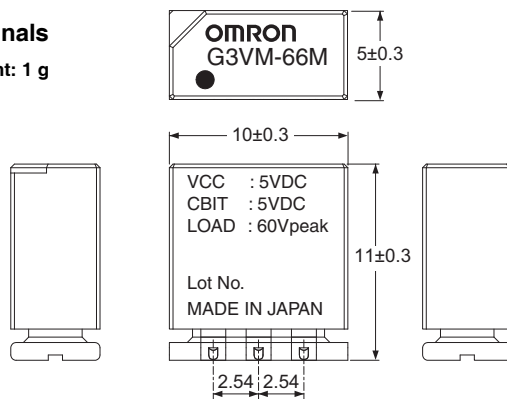
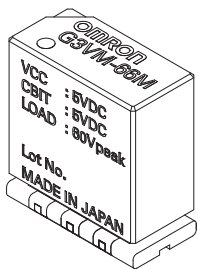

### Actual Mounting Pad Dimensions (Recommended Value, Top View)

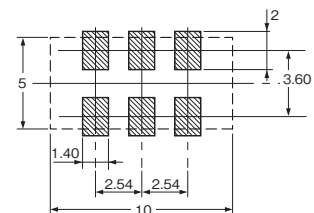

**Note:** The actual product is marked differently from the image shown here.

## Safety Precautions

### Caution

Always turn OFF the power supply before performing wiring. Not doing so may cause electrical shock.

### Precautions for Safe Use

- (1) Do not apply overvoltage or overcurrent to the input circuit / output circuit of the MOS FET relay.  
This can occasionally cause failure or burning of the MOS FET relay.
- (2) Please follow recommended soldering condition. Incomplete soldering procedure can lead to abnormal heat generation during operation and result in heat damage to internal components.
- (3) Do not transport the MOS FET relay under the following locations. Doing so may occasionally result in damage, malfunction, or deterioration of performance characteristics.
  - Locations subject to water or oil
  - Locations subject to high temperature or high humidity
  - Locations subject to condensation due to rapid changes in temperature
- (4) Do not use or store the MOS FET relay in the following locations. Doing so may result in damage, malfunction, or deterioration of performance characteristics.
  - Locations subject to corrosive gases or inflammable gases
  - Locations subject to temperature beyond specified conditions
  - Locations subject to humidity beyond specified conditions
  - Locations subject to high temperature or high humidity
  - Locations subject to dust, salt, or iron, or locations where there is salt damage
  - Locations subject to rainwater or water splashes
  - Locations subject to direct sunlight
- (5) Do not drop the MOS FET relay or subject it to abnormal vibration or shock during transportation or mounting. Doing so may result in deterioration of performance, malfunction, or failure.
- (6) Make sure that the hand soldering is only once at 260°C or less within 20 seconds. Also, do not attach the soldering iron directly to the plating part of the MOS FET relay, so attach the soldering iron to the pad part of the substrate to be mounted. If it is done twice or more including rework, the plating part of the MOS FET relay may peel off and there is a possibility of poor conduction.
- (7) Make sure that there is no excess ambient temperature rise due to the heat generation of the MOS FET relay. If the MOS FET relay is mounted inside a panel, install a fan so that the interior of the panel is fully ventilated.
- (8) Select a load within the rated values. Not doing so may result in malfunction, failure, or burning.
- (9) Use a power supply within the rated frequencies. Otherwise, malfunction, failure, or burning may occasionally occur.
- (10) The MOS FET relay may occasionally rupture if short-circuit current flows. As protection against accidents due to short circuiting, be sure to install protective devices, such as fuses and no-fuse breakers, on the power supply side.
- (11) If a voltage is generated from the stray capacitance to cause a return failure, connect a bleeder resistor to input end.

### Precautions for Correct Use

- (1) Derating design  
Consideration for derating is critical for achieving required system reliability. Attention should be paid for derating against maximum rating and recommended operating conditions. In addition to this, there should be enough margin based on machine and environmental conditions.
  - 1) Maximum rating  
The maximum rating is a standard that must not be exceeded even momentarily and can not exceed any of multiple ratings. If it exceeds the maximum rating, degradation inside the MOS FET relay and breakage of the chip may result. For this reason, in order to use the MOS FET relay with high reliability, please design a sufficient derating against the maximum rated voltage, current and temperature.
  - 2) Recommended Operating Conditions  
Recommended operating conditions are recommended conditions to ensure operation and return of MOS FET relays. In order to use the MOS FET relay with high reliability, please consider the recommended operating conditions and design.
  - 3) Fail-safe implementation  
If there is a possibility that failure, characteristic deterioration, malfunction, etc. of the MOS FET relay will have a serious effect on the safe operation of the system, we recommend implementing a fail-safe measure according to the application.
- (2) Protection against input surge voltage  
When a surge voltage in the reverse direction is applied to the input terminal, insert a diode anti-parallel to the input terminal and do not apply a reverse voltage of 3 V or more.
- (3) Protection circuit against overvoltage on the output side  
In the case of an inductive load or the like where an overvoltage exceeding the absolute maximum rating occurs between the output terminals, connect a protection circuit to limit the overvoltage.
- (4) About load connection method  
If short-circuiting the input / output terminals during operation of the MOS FET relay will cause malfunction, do not short circuit.
- (5) Cleaning
  - 1) For flux cleaning, please clean so that reactive ions such as sodium and chlorine do not remain. Depending on the organic solvent, it may react with water to generate corrosive gases such as hydrogen chloride, which may degrade the MOS FET relay.
  - 2) Before cleaning with water, please do not leave any reactive ions such as sodium, chlorine, etc. in particular.
  - 3) Do not scrub the display mark face with a brush or hand while washing or with cleaning solution adhering to the MOS FET relay. The display mark may disappear.

- 4) Dip cleaning, shower cleaning, and steam cleaning are performed by chemical action of solvent. Consider immersion time in solvent and steam within 1 minute at liquid temperature of 50°C or less, taking into consideration influence on MOS FET relay.
- 5) Dry thoroughly after cleaning so that there is no residue of cleaning solution.
- (6) Soldering mounting  
Soldering should be performed within the recommended conditions below to prevent the temperature rise of the main body as much as possible.

Mounting solder	Preliminary heating	Soldering		Times
(Lead-free solder) SnAgCu	120 to 170°C 130 seconds or less	200°C 50 seconds or less	peak 220°C or less	Only once

**Note:** When using, we recommend you to check under customer's actual use conditions.

### ● Recommended conditions for IRS Method

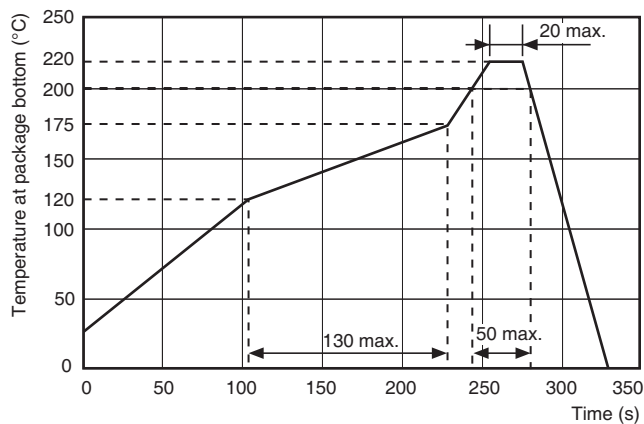

- (7) Transporting  
Do not transport under the condition that the MOS FET relay is not packaged. It may cause damage or breakdown.
- (8) Wiring
  - 1) Use a power supply with low noise.
  - 2) Do not wire any wiring in the same duct or conduit as power or high-tension lines. Otherwise, inductive noise may damage the MOS FET relay or cause it to malfunction.
  - 3) Do not handle the MOS FET relay with oily or dusty (especially iron dust) hands.
- (9) Storage conditions
  - 1) Please keep it in a place where there is no possibility of water or where it is not exposed to direct sunlight.
  - 2) When transporting or storing, follow the warning notice to the packing tube.
  - 3) Please keep the storage place at normal temperature, normal humidity and normal pressure. Temperature and relative humidity should be 5 to 35°C, relative humidity 45 to 75% as a guide.
  - 4) Store in a place where corrosive gas, such as hydrogen sulfide gas and salt wind, do not hit the product and where there is no dust that can be visually confirmed.
  - 5) Please keep MOS FET relay in a place with little temperature change. Drastic temperature change during storage leads to dew condensation, lead oxidation, corrosion, etc., causing poor solder wettability.

- 6) When removing the MOS FET relay from the packaging and storing it again, please use the antistatic storage container.
- 7) In any case, please do not add power to make the product deform or alter.
- 8) The warranty period of our products will be one year after delivery or after delivery to the designated location. We recommend that you check the solderability before use if over a year or more has passed in normal storage mode.
- 9) When storing, keep the packing bag without opening it. Use it within 72 hours after opening.

### (10) Terms of use

#### <Temperature>

Each electrical characteristic of the MOS FET relay is limited by the operating temperature. If it is used at a temperature outside the operating range, not only the electrical characteristics are not realized, but also the deterioration of the MOS FET relay is accelerated. For this reason, please note the temperature characteristics beforehand and design with \*derating. (\* Derating: Reduce stress)

For operating temperature condition, consider the derating and use the recommended operating temperature as a guide.

#### <Humidity>

Long-term use under high humidity environment may cause deterioration or malfunction of internal chip due to moisture intrusion into inside the MOS FET relay. In systems with high signal source impedance, this board leaks and leakage between the leads of the MOS FET relay may cause malfunction. In such a case, please consider the moisture proof treatment of the MOS FET relay surface.

Meanwhile, at low humidity, damage due to discharge of static electricity becomes a problem, so please use it in the humidity range of relative humidity 40 to 60% unless moisture proof treatment is carried out.

### (11) About static electricity countermeasures

If static electricity is discharged to each terminal at the time of product handling etc., it may cause damage to the internal elements or degradation of function. Minimize the generation of static electricity as much as possible and take appropriate countermeasures against static electricity to prevent electric charge from accumulating around the product.

### (12) MOS FET Relay Output Noise Surges

If there is a large voltage surge in the AC current being used by the MOS FET Relay, the MOS FET Relay transient peak element voltage will be exceeded, causing overvoltage damage to the MOS FET Relay. Be sure to take countermeasures against surge, such as adding a surge absorbing element.

• Application examples provided in this document are for reference only. In actual applications, confirm equipment functions and safety before using the product.  
• Consult your OMRON representative before using the product under conditions which are not described in the manual or applying the product to nuclear control systems, railroad systems, aviation systems, vehicles, combustion systems, medical equipment, amusement machines, safety equipment, and other systems or equipment that may have a serious influence on lives and property if used improperly. Make sure that the ratings and performance characteristics of the product provide a margin of safety for the system or equipment, and be sure to provide the system or equipment with double safety mechanisms.

## OMRON Corporation

Electronic and Mechanical Components Company

### Regional Contact

#### Americas

<https://www.components.omron.com/>

#### Asia-Pacific

<https://ecb.omron.com.sg/>

#### Korea

<https://www.omron-ecb.co.kr/>

#### Europe

<http://components.omron.eu/>

#### China

<https://www.ecb.omron.com.cn/>

#### Japan

<https://www.omron.co.jp/ecb/>