

SPECTRACOOL INDOOR/OUTDOOR

G57
20000 BTU/Hr.
5861 Watt

G52
8000/12000 BTU/Hr.
2300/3500 Watt

G28
4000/6000 BTU/Hr.
1172/1758 Watt

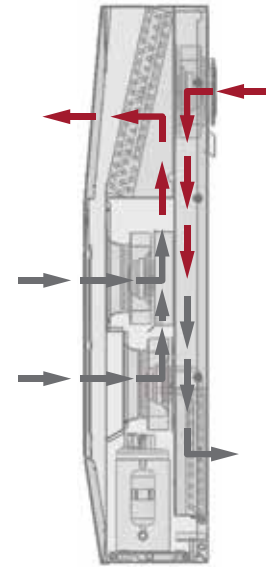

■ Clean AirFlow
■ Ambient AirFlow

INDUSTRY STANDARDS

UL/cUL Listed; Type 12, 3R, 4; 4X optional; File No. SA6453

CE
EAC
IP 56 Internal Loop
IP 34 on External Loop
Telcordia GR-487 capable (Outdoor)

APPLICATION

- Industrial automation
- Telecommunications equipment
- Waste water treatment systems
- Package handling equipment
- Security and defense systems
- And more

FEATURES

- Energy-efficient rotary compressor on most models
- R407c and R134a earth-friendly refrigerants
- 115, 230 and 400/460 VAC 3-phase power input on most models
- UL Listed to save customers time and money with agency approvals
- Outdoor model operating temperature range from -40 F/-40 C to 131 F/55 C
- Exterior and partially recessed mounting options
- Attractive industrial design with minimal use of visible fasteners
- Reliable mechanical thermostat on enclosure side of the unit; indoor air conditioner models include digital display on ambient side
- Dual condenser-side air movers for performance redundancy on G52 and G57 models
- Galvanized sheet-metal cover for rugged factory and outdoor environments
- Easy-mount flanges for simple installation
- Cut-out adapter options for enclosures with GENESIS and T-Series air conditioners, enable users to easily transition to the new unit

- Dust-resistant condenser coil allows the unit to be run filterless in most applications
- Cleanable, reusable aluminum mesh filter protects coils for maximum cooling performance
- Mounting hardware, gaskets and user manual furnished with the unit
- Every unit functionally tested before shipping
- Standard Indoor Air Conditioner models also include:
 - Active condensate management with heater strip
 - Power-off relay for door switch and other system requirements
 - Malfunction switch
- Standard Outdoor Air Conditioner models also include:
 - Telcordia GR-487 capable
 - Corrosion-resistant components
 - Malfunction switch
 - Compressor heater
 - Head pressure control
 - Up to 2000 Watt (G28, G52) and 3000 Watt (G57) enclosure heater

SPECIFICATIONS

- Nominal cooling capacity:
 - G28 4000 & 6000 BTU/Hr. (1172 and 1758 W)
 - G52 8000 & 12000 BTU/Hr. (2344 and 3516 W)
 - G57 20000 BTU/Hr. (5861 W)
- Outdoor model operating temperature range from -40 F/-40 C to 131 F/55 C

FINISH

- RAL 7035 light-gray, semi-textured powder-coat paint
- Other colors and textures available

NOTES

Visit www.PentairProtect.com to download 2D and 3D CAD drawings into the overall design of your electrical system.

Performance Data **G28 Models 4000/6000 BTU/Hr. (1172/1758 Watt)**

| CATALOG NUMBER | | | | | | |
|---|--|------------------|-------------------|------------------|------------------|-------------------|
| Indoor Model | G280416G050 | G280426G050 | G280446G050 | G280616G050 | G280626G050 | G280646G050 |
| Indoor Model Stainless Steel Type 4X | G280416G051 | G280426G051 | G280446G051 | G280616G051 | G280626G051 | G280646G051 |
| Indoor Model with Remote Access Control* | G280416G060 | G280426G060 | G280446G060 | G280616G060 | G280626G060 | G280646G060 |
| Outdoor Model without Heat Pkg. | G280416G100 | G280426G100 | G280446G100 | G280616G100 | G280626G100 | G280646G100 |
| Outdoor Model Partial Recessed Mount | G280416G101 | G280426G101 | G280446G101 | G280616G101 | G280626G101 | G280646G101 |
| Outdoor Model without Heat Pkg. Stainless Steel Type 4X | G280416G102 | G280426G102 | G280446G102 | G280616G102 | G280626G102 | G280646G102 |
| Outdoor Model with Heat Pkg. | G280416G150 | G280426G150 | — | G280616G150 | G280626G150 | — |
| Outdoor Model with Heat Pkg. Stainless Steel Type 4X | G280416G151 | G280426G151 | — | G280616G151 | G280626G151 | — |
| COOLING PERFORMANCE | | | | | | |
| Nominal: | | | | | | |
| BTU/Hr. | 4000 | 4600/4900 | 4600/4900 | 6000/6400 | 6000/6400 | 5400/6000 |
| Watts | 1172 | 1347/1435 | 1347/1435 | 1757/1874 | 1757/1874 | 1581/1757 |
| At 131 F/131 F (55 C/55 C): | | | | | | |
| BTU/Hr. (50/60 Hz) | 3700 | 4600/4900 | 4600/4900 | 6000/6400 | 6000/6400 | 5400/6000 |
| W (50/60 Hz) | 1084 | 1347/1435 | 1347/1435 | 1757/1874 | 1757/1874 | 1581/1757 |
| At 95 F/95 F (35 C/35 C): | | | | | | |
| BTU/Hr. (50/60 Hz) | 3300/3410 | 4300/4600 | 4324/4655 | 5600/6000 | 5600/6000 | 5054/5685 |
| W (50/60 Hz) | 967/1000 | 1260/1364 | 1267/1364 | 1641/1758 | 1641/1758 | 1481/1666 |
| Refrigerant | R134A | R407C | R134A | R407C | R407C | R134A |
| Refrigerant Charge (ounces/grams) | 12/340 | 20/567 | 16/454 | 20/567 | 20/567 | 16/454 |
| Operating Temperature Range: | | | | | | |
| Maximum (°F/°C) | 131 F/55 C | 131 F/55 C | 131 F/55 C | 131 F/55 C | 131 F/55 C | 131 F/55 C |
| Minimum (°F/°C) | -40 F/-40 C | -40 F/-40 C | -40 F/-40 C | -40 F/-40 C | -40 F/-40 C | -40 F/-40 C |
| Air Flow at 0 Static Pressure: | | | | | | |
| Internal loop 50 Hz (CFM / m ³ /hr.) | 151/256 | 189/321 | 189/321 | 189/321 | 189/321 | 189/321 |
| External loop 50 Hz (CFM / m ³ /hr.) | 284/482 | 291/494 | 291/494 | 291/494 | 291/494 | 291/494 |
| Internal loop 60 Hz (CFM / m ³ /hr.) | 183/310 | 221/375 | 221/375 | 221/375 | 221/375 | 221/375 |
| External loop 60 Hz (CFM / m ³ /hr.) | 290/492 | 300/509 | 300/509 | 300/509 | 300/509 | 300/509 |
| Max. Heater W (Outdoor Models) | 1000 | 2000 | | 2000 | 2000 | |
| ELECTRICAL DATA | | | | | | |
| Rated Voltage | 115 | 230 | 400/460 3~ | 115 | 230 | 400/460 3~ |
| Frequency (Hz) | 50/60 | 50/60 | 50/60 | 50/60 | 50/60 | 50/60 |
| Operating Range | +/- 10% | +/- 10% | +/- 10% | +/- 10% | +/- 10% | +/- 10% |
| Max. Power Consumption (W at 50/60 Hz) | 465/1055 | 1058/1334 | 680/874 | 1138.5/1311 | 1058/1334 | 680/874 |
| Max. Nominal Current (A at 50/60 Hz) | 10.4/10.1 | 4.6/5.8 | 1.7/1.9 | 9.9/11.4 | 4.6/5.8 | 1.7/1.9 |
| Starting Current (A) | 36.2 | 17.7 | 7.7 | 36.2 | 17.7 | 7.7 |
| Agency Approvals | UL/cUL Listed CE EAC | | | | | |
| Power Input Description | Terminal Block | | | | | |
| ENCLOSURE PROTECTION | | | | | | |
| UL Type | Type 12, 3R, 4 Standard Type 4X Stainless Steel Optional | | | | | |
| CONTROLLER | | | | | | |
| Description | Basic Mechanical Thermostat | | | | | |
| Thermostat Location | Enclosure Side on All Base Models | | | | | |
| Factory Thermostat Setting (°F/°C) | 80/27 | 80/27 | 80/27 | 80/27 | 80/27 | 80/27 |
| SOUND LEVEL | | | | | | |
| At 1.5 Meters | 68 dB(A) | | | | | |
| UNIT CONSTRUCTION | | | | | | |
| Material | Galvanized Sheet Metal Standard (Optional: Stainless Steel) | | | | | |
| Finish | Powder Coat RAL 7035 Light Gray Standard | | | | | |
| ACCESSORIES | | | | | | |
| EASYSWAP Adaptor Plenum (GENESIS M28) | Enables SPECTRACOOOL to be mounted to GENESIS M28 air conditioner cutout Catalog Number PLM28G28 | | | | | |
| EASYSWAP Adaptor Plenum (T-Series T29) | Enables SPECTRACOOOL to be mounted to T-Series T29 air conditioner cutout Catalog Number PLT29G28 | | | | | |
| UNIT DIMENSIONS | | | | | | |
| Height (in./mm) | 28.55/725.1 | | | | | |
| Width (in./mm) | 16.97/431.1 | | | | | |
| Depth (in./mm) | 10.10/256.6 | | | | | |
| Weight (lb./kg) | 84/38 | 84/38 | 84/38 | 84/38 | 84/38 | 84/38 |

*Units with Remote Access Control utilize a digital controller and communicate via EtherNet/IP, Profinet, Modbus TCP/IP and SNMP over ethernet or modbus RTU over USB.

Performance Curves for G28 Models 4000 BTU/Hr. (1347/1435 Watt)

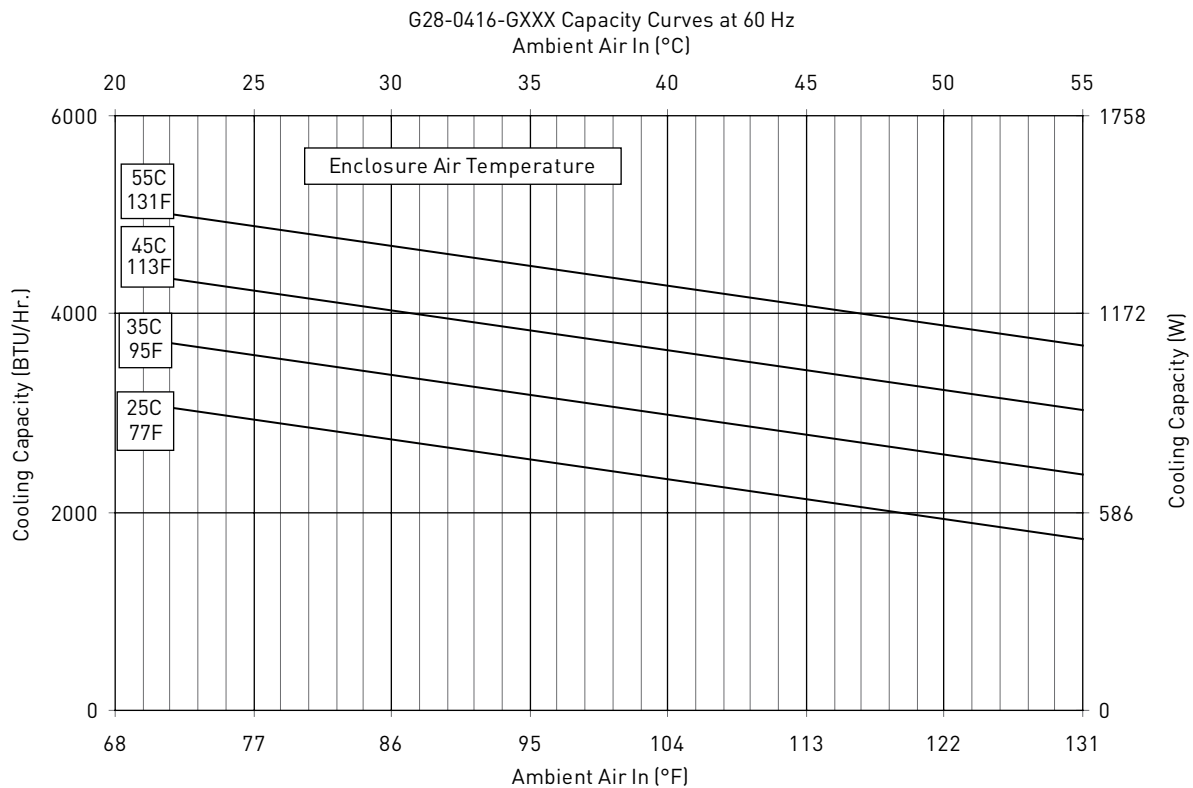
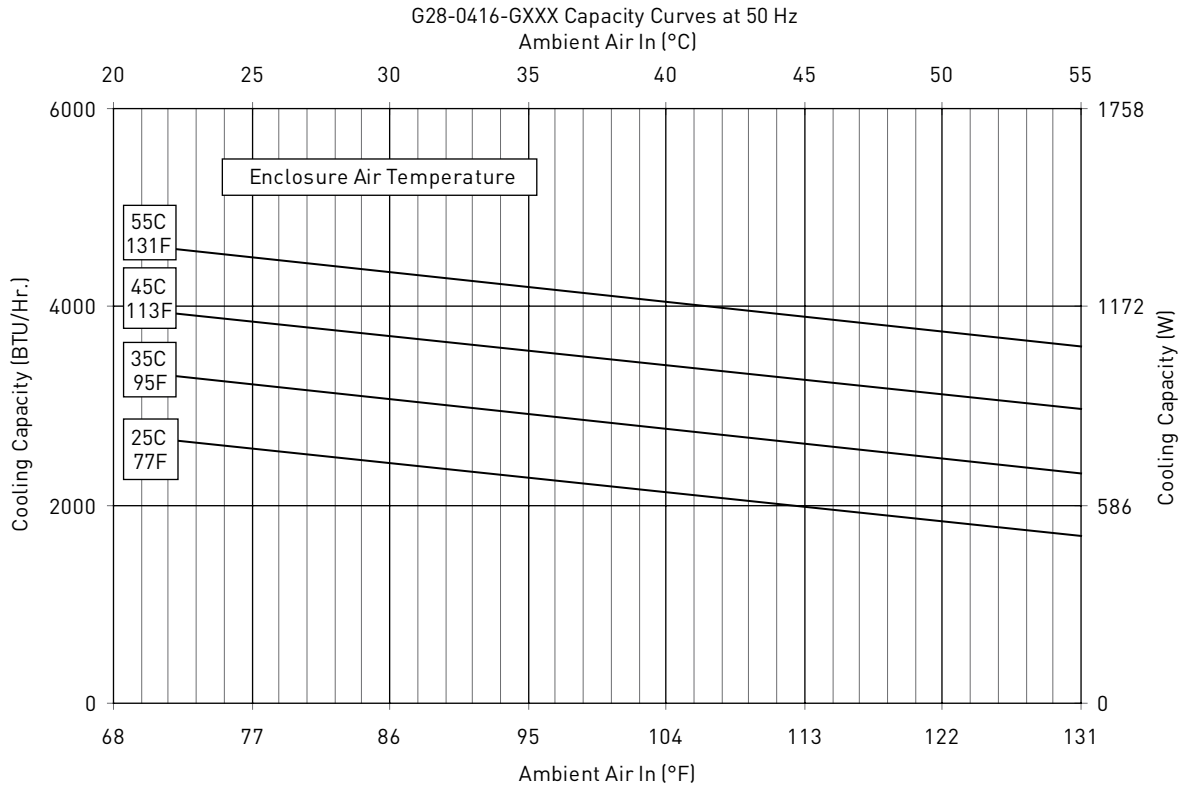

Performance Curves for G28 Models 4000 BTU/Hr. (1347/1435 Watt)

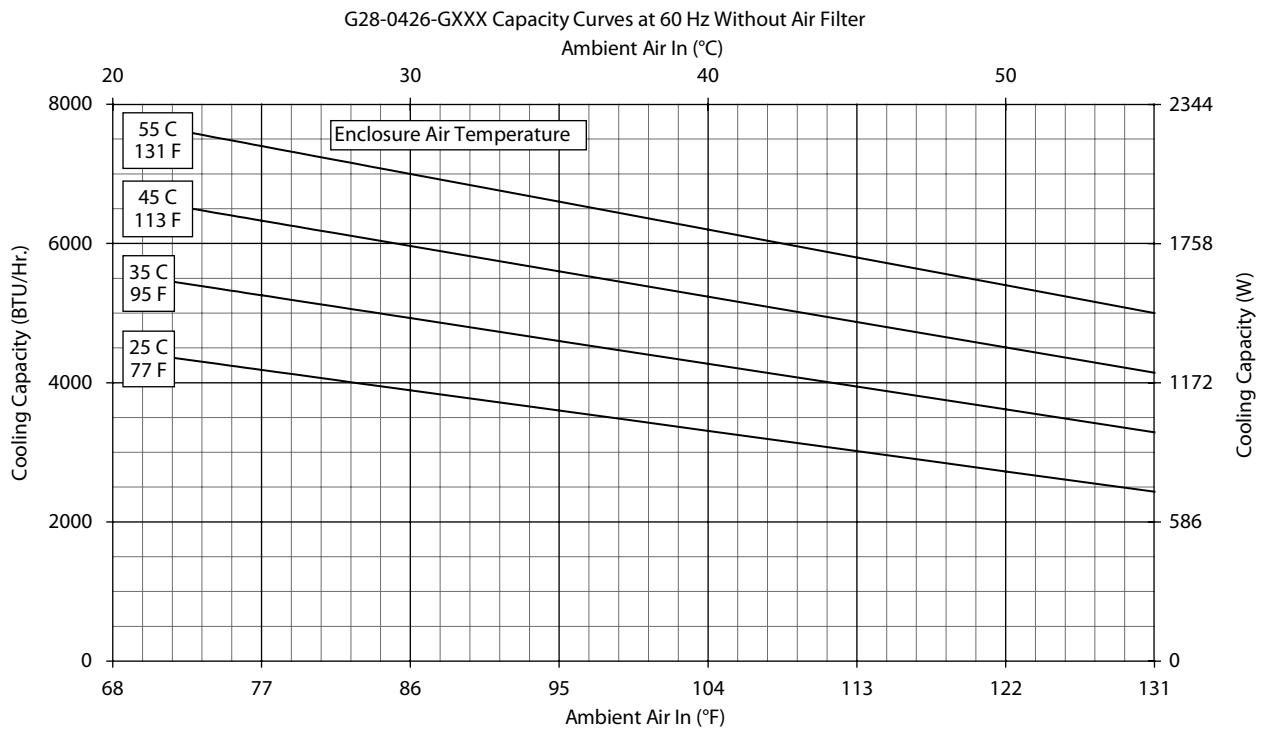
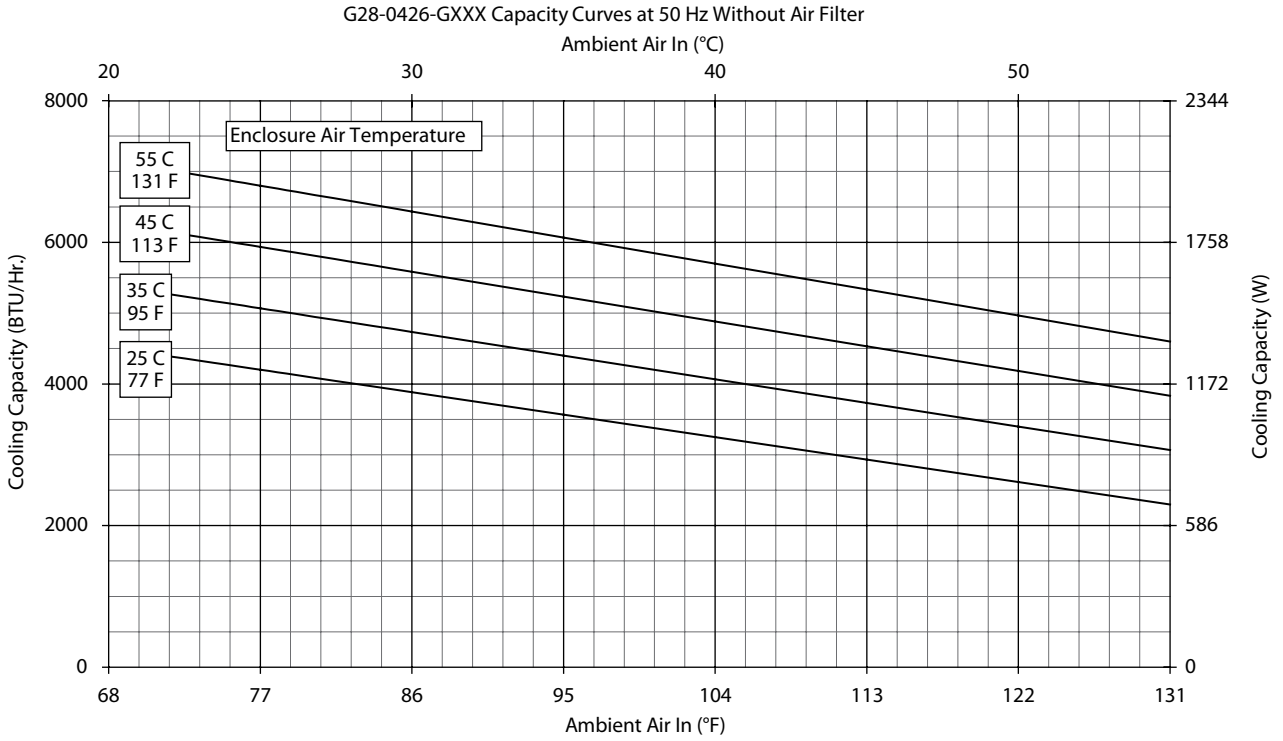

Performance Curves for G28 Models 4000 BTU/Hr. (1347/1435 Watt)

G28-0446-GXXX- Capacity Curves at 50 Hz; Without Filter

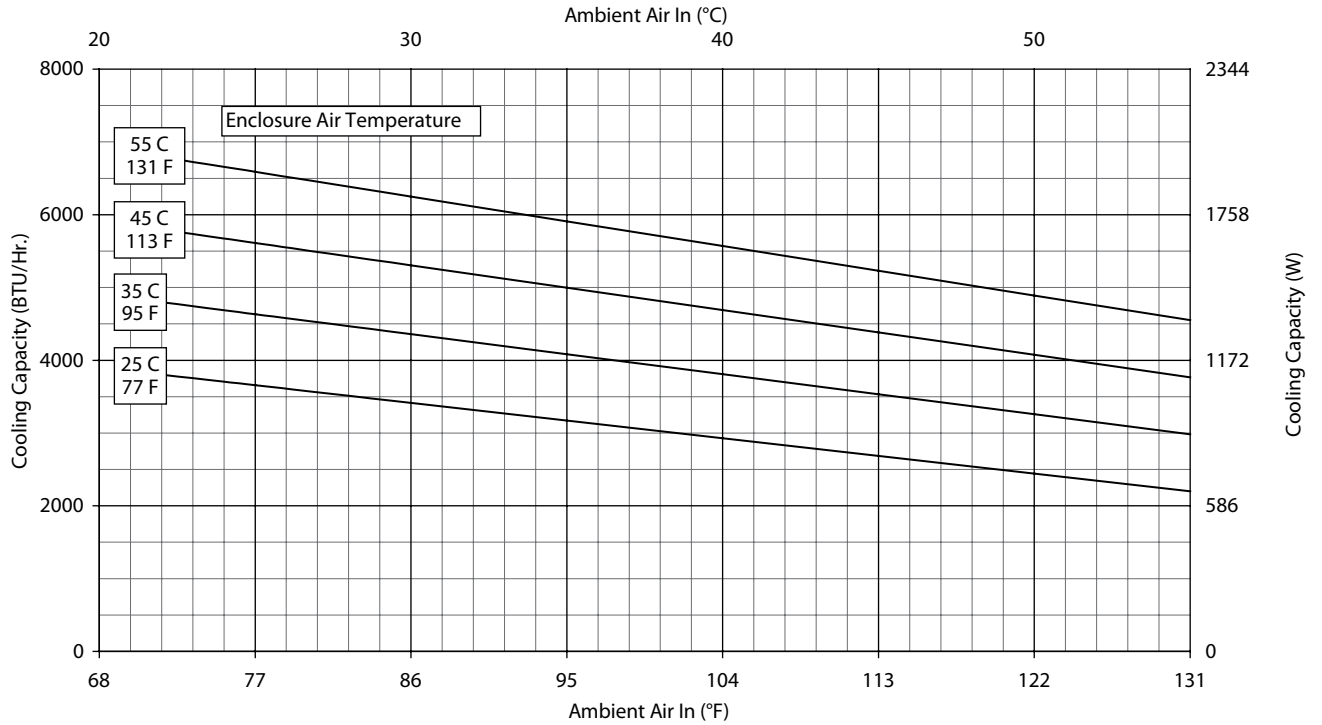

G28-0446-GXXX- Capacity Curves at 60 Hz; Without Filter

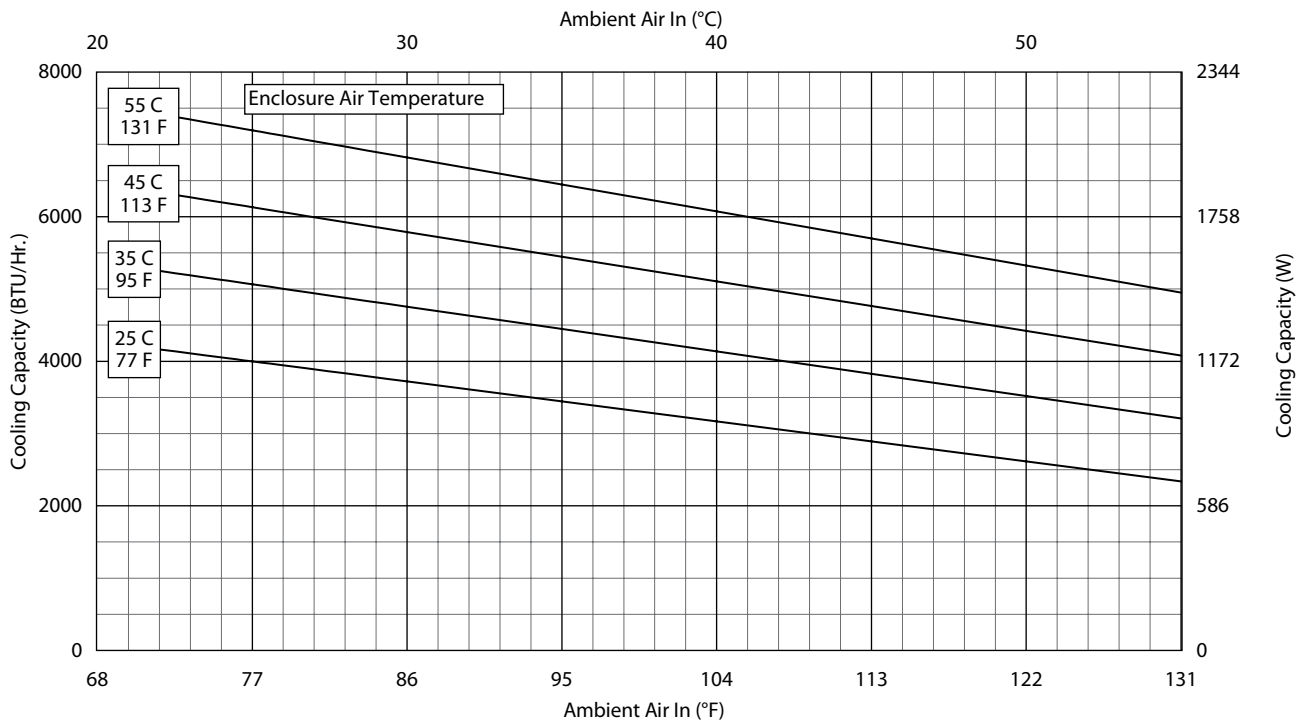

Performance Curves for G28 Models 4000/6000 BTU/Hr. (1172/1758 Watt)

G28-06(1/2)6-GXXX Capacity Curves at 50 Hz Without Filter

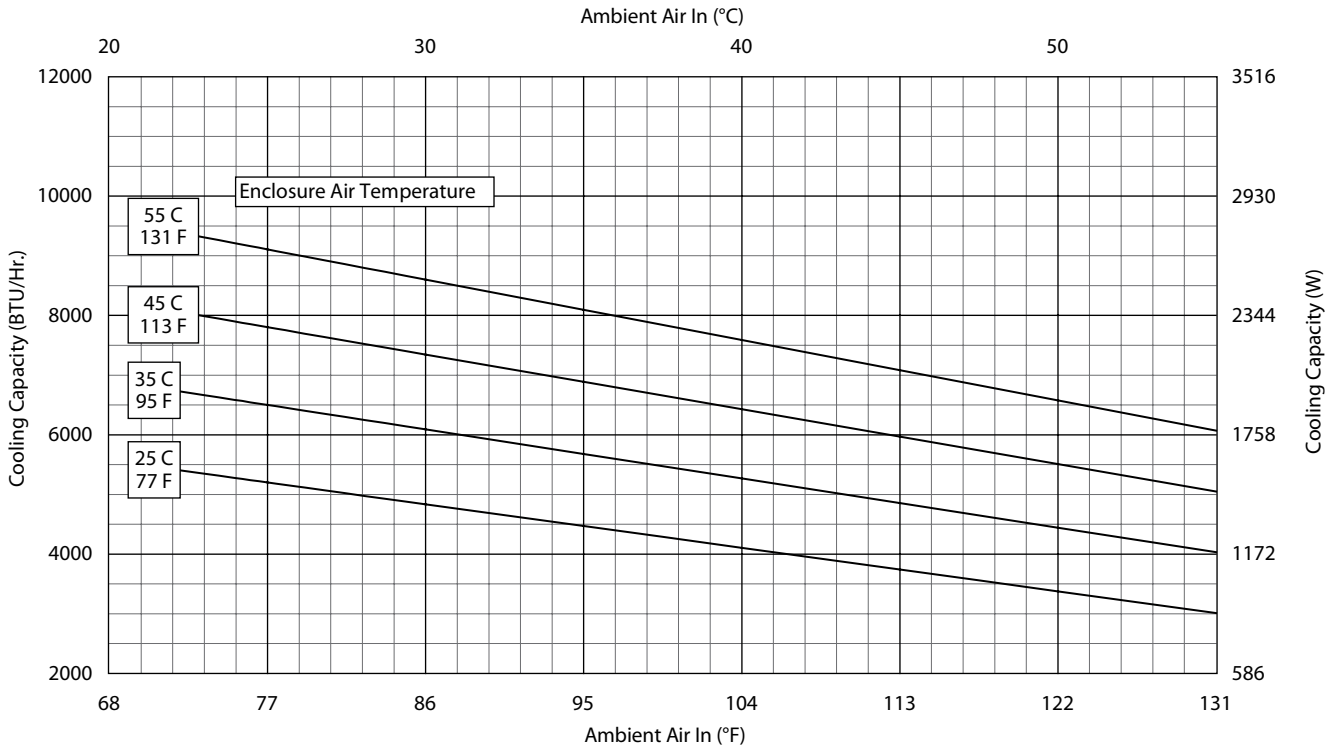

G28-06(1/2)6-G002-P#2 Capacity Curves at 60 Hz Without Filter

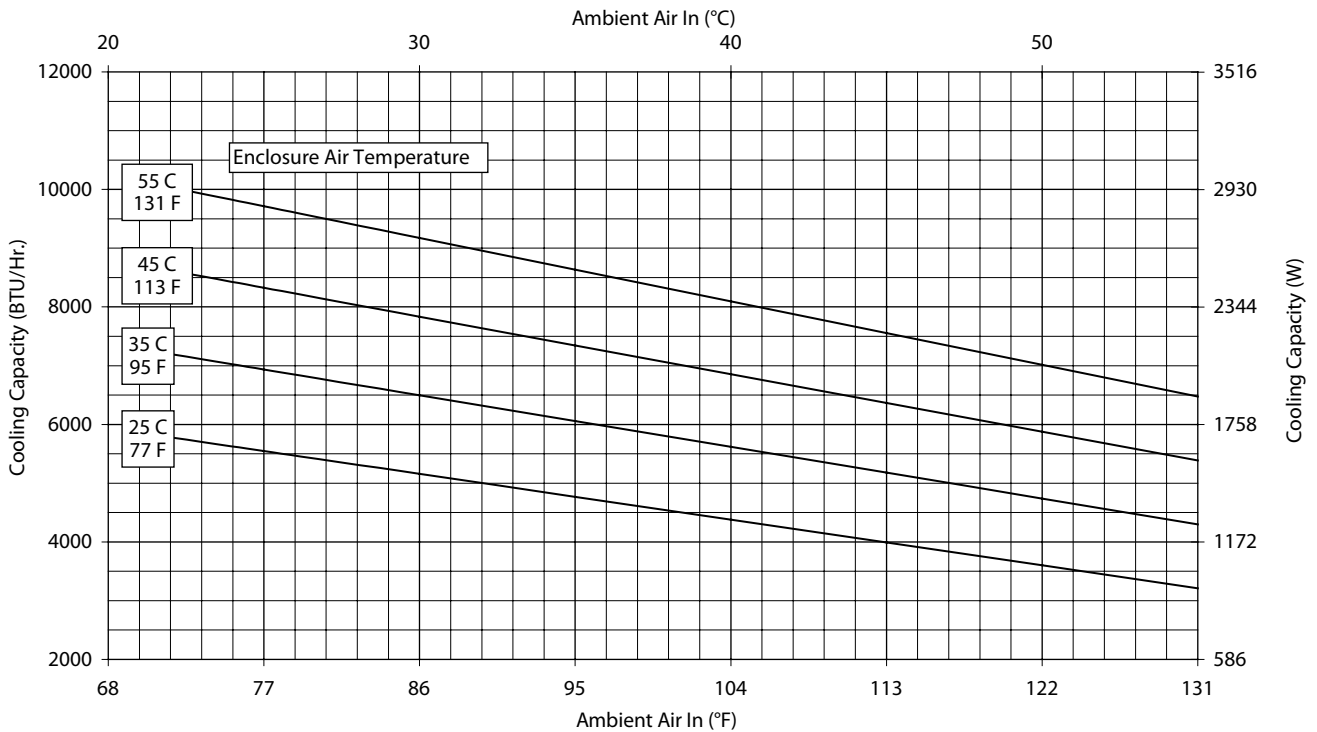

Performance Curves for G28 Models 6000 BTU/Hr. (1758 Watt)

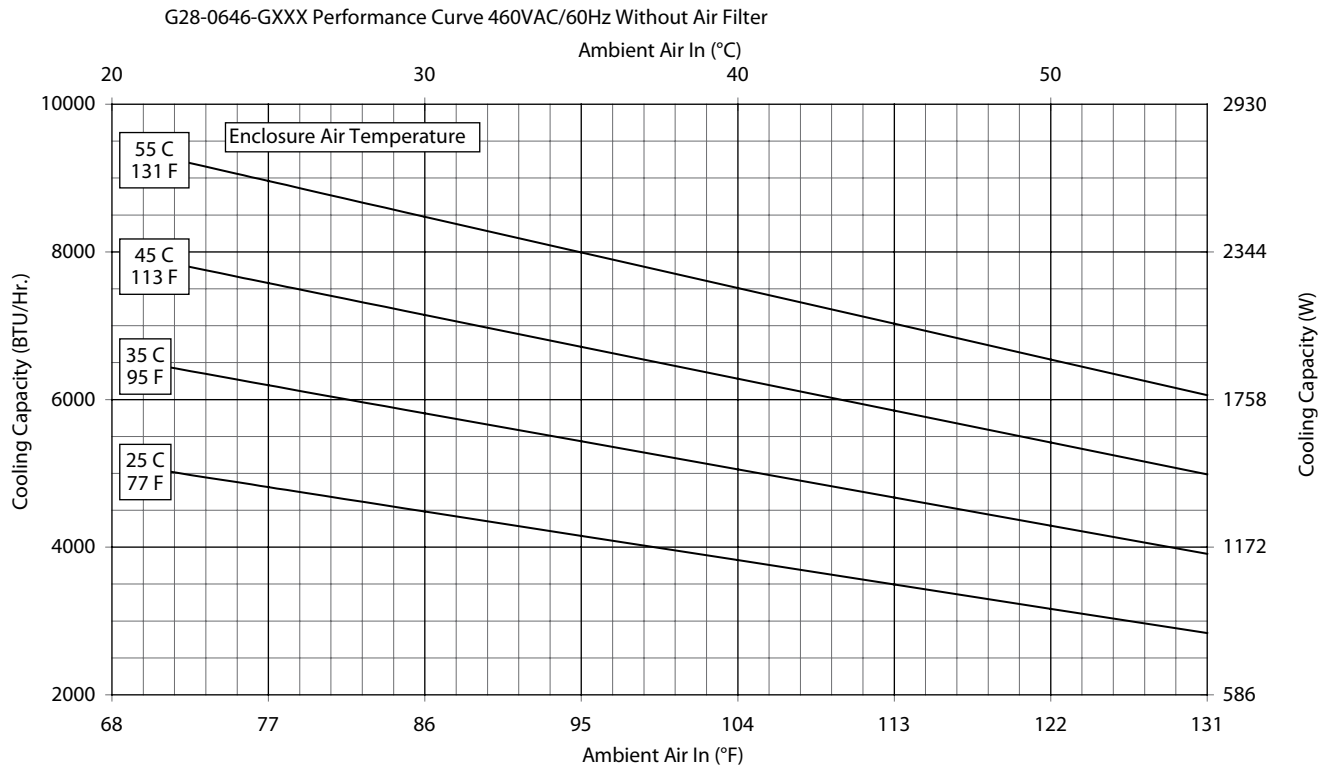
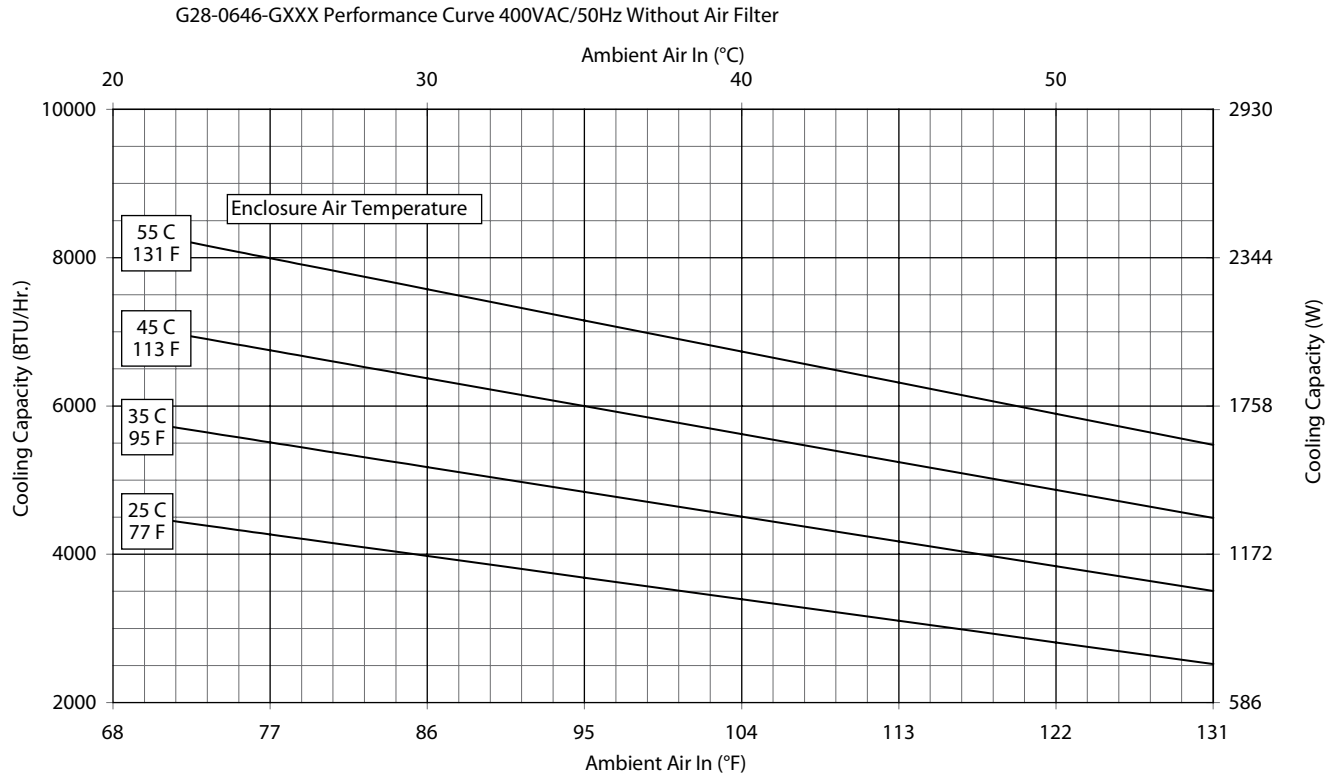

G28 Models 4000 BTU/Hr. 230/460 V, 6000 BTU/Hr. 115/230/460 V (1172/1757 Watt)

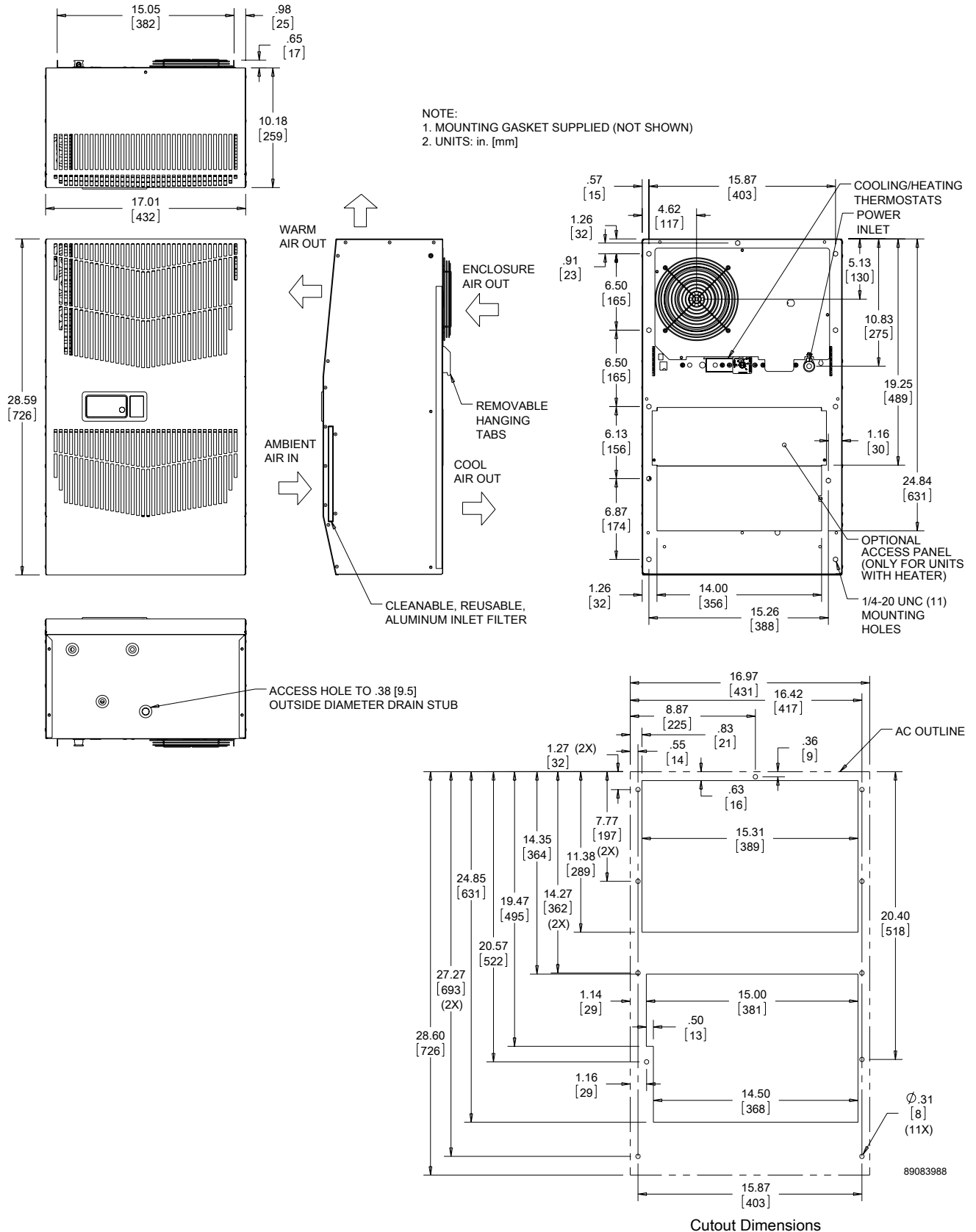

Visit www.PentairProtect.com to download 2D and 3D CAD drawings into the overall design of your electrical system.

G28 Models 4000 BTU/Hr. 115 V (1172 Watt) Partial Recess

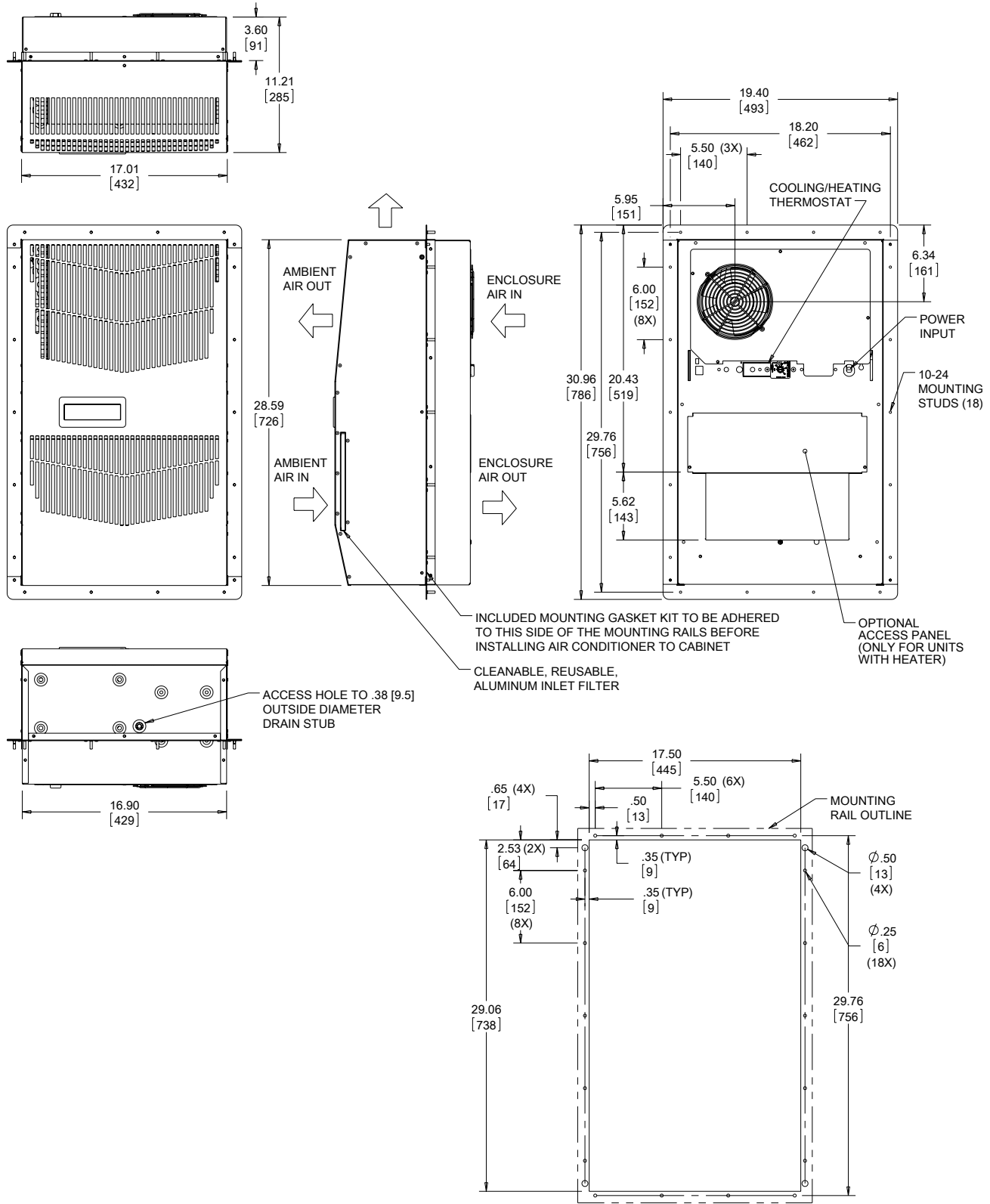

Cutout Dimensions

Visit www.PentairProtect.com to download 2D and 3D CAD drawings into the overall design of your electrical system.

G28 Model 4000 BTU/Hr. 230/460 V, 6000 BTU/Hr. 115/230/460 V (1172/1758 Watt) Partial Recess

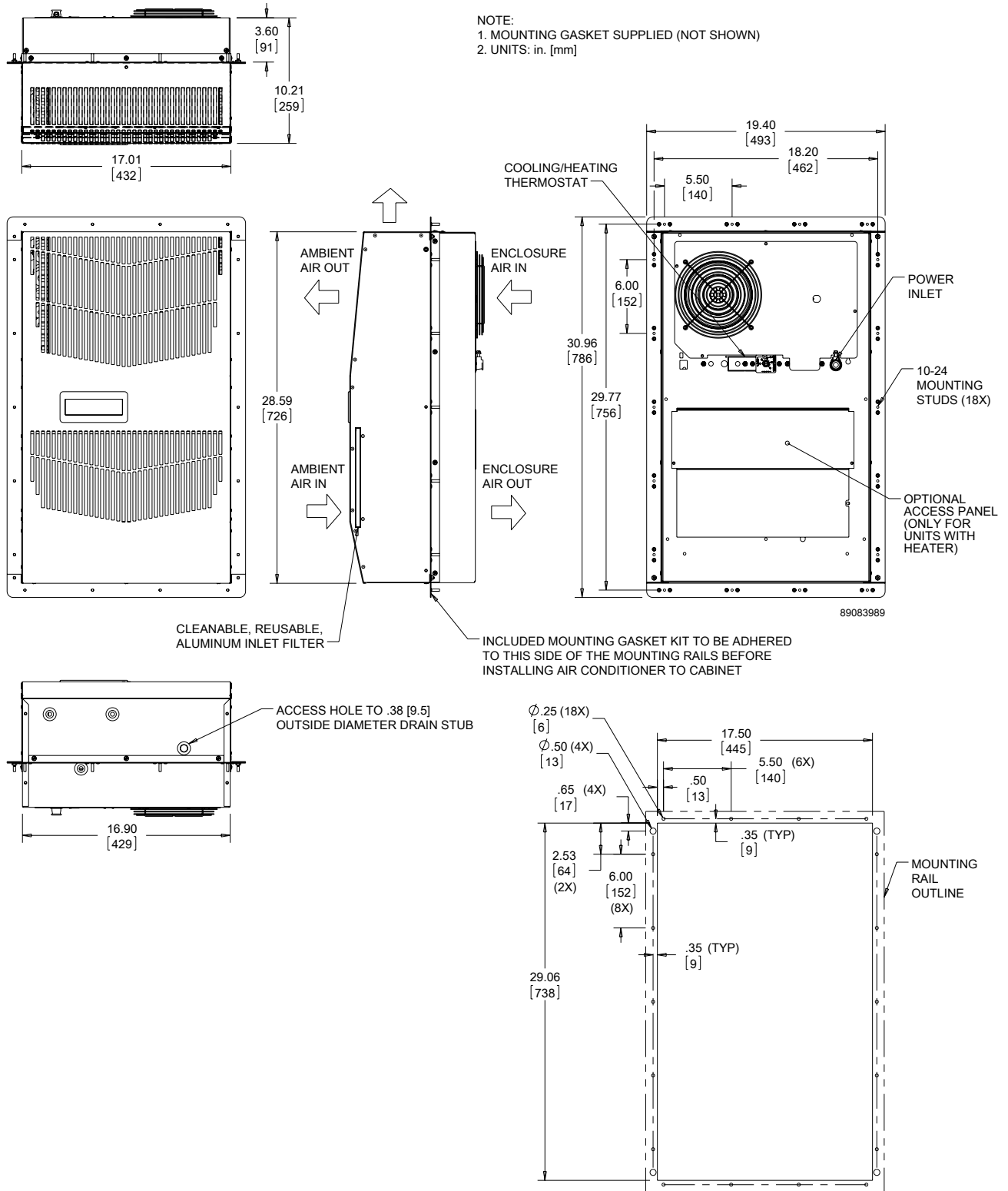

Cutout Dimensions

Visit www.PentairProtect.com to download 2D and 3D CAD drawings into the overall design of your electrical system.

Performance Data **G52 Models 8000/12000 BTU/Hr. (2300/3500 Watt)**

| CATALOG NUMBER | | | | | | |
|---|--|--------------------|-------------------|--------------|--------------------|-------------------|
| Indoor Model | G520816G050 | G520826G050 | G520846G050 | G521216G050 | G521226G050 | G521246G050 |
| Indoor Model Stainless Steel Type 4X | G520816G051 | G520826G051 | G520846G051 | G521216G051 | G521226G051 | G521246G051 |
| Indoor Model with Remote Access Control* | G520816G060 | G520826G060 | G520846G060 | G521216G060 | G521226G060 | G521246G060 |
| Outdoor Model without Heat Pkg. | G520816G100 | G520826G100 | G520846G100 | G521216G100 | G521226G100 | G521246G100 |
| Outdoor Model Partial Recessed Mount | G520816G101 | G520826G101 | G520846G101 | G521216G101 | G521226G101 | G521246G101 |
| Outdoor Model without Heat Pkg. Stainless Steel Type 4X | G520816G102 | G520826G102 | G520846G102 | G521216G102 | G521226G102 | G521246G102 |
| Outdoor Model with Heat Pkg. | G520816G150 | G520826G150 | G520846G150 | G521216G150 | G521226G150 | G521246G150 |
| Outdoor Model with Heat Pkg. Stainless Steel Type 4X | G520816G151 | G520826G151 | G520846G151 | G521216G151 | G521226G151 | G521246G151 |
| COOLING PERFORMANCE | | | | | | |
| Nominal: | | | | | | |
| BTU/Hr. | 8000 | 8000 | 8000 | 12000 | 12000 | 12000 |
| Watts | 2300 | 2300 | 2300 | 3500 | 3500 | 3500 |
| At 131 F/131 F (55 C/55 C): | | | | | | |
| BTU/Hr. | 7300/8200 | 7300/8200 | 8800/9800 | 12000/12500 | 12000/12500 | 11100/12000 |
| Watts | 2139/2403 | 2139/2403 | 2578/2871 | 3516/3662 | 3516/3662 | 3252/3516 |
| At 95 F/95 F (35 C/35 C): | | | | | | |
| BTU/Hr. | 6000/6800 | 6000/6800 | 7400/8200 | 9900/10700 | 9900/10700 | 9900/10700 |
| Watts | 1758/1992 | 1758/1992 | 2168/2402 | 2900/3135 | 2900/3135 | 2900/3135 |
| Refrigerant | R134a | R134a | R134a | R134a | R134a | R134a |
| Refrigerant Charge (ounces/grams) | 24/680 | 24/680 | 24/680 | 38/1077 | 38/1077 | 38/1077 |
| Operating Temperature Range: | | | | | | |
| Maximum (°F/°C) | 131/55 | 131/55 | 131/55 | 131/55 | 131/55 | 131/55 |
| Indoor Minimum (°F/°C) | 50/10 | 50/10 | 50/10 | 50/10 | 50/10 | 50/10 |
| Outdoor Minimum (°F/°C) | -40/-40 | -40/-40 | -40/-40 | -40/-40 | -40/-40 | -40/-40 |
| Airflow at 0 Static Pressure: | | | | | | |
| Internal loop 50 Hz (CFM / m ³ /hr.) | 285/484 | 285/484 | 285/484 | 287/487 | 287/487 | 287/487 |
| External loop 50 Hz (CFM / m ³ /hr.) | 650/1104 | 650/1104 | 650/1104 | 635/1078 | 635/1078 | 635/1078 |
| Internal loop 60 Hz (CFM / m ³ /hr.) | 310/527 | 310/527 | 310/527 | 305/518 | 305/518 | 305/518 |
| External loop 60 Hz (CFM / m ³ /hr.) | 700/1189 | 700/1189 | 700/1189 | 650/1104 | 650/1104 | 650/1104 |
| Max. Heater W (Outdoor Models): | 2000 | 2000 | NA | 2000 | 2000 | NA |
| ELECTRICAL DATA | | | | | | |
| Rated Voltage | 115 | 230/208-230 | 400/460 3~ | 115 | 230/208-230 | 400/460 3~ |
| Frequency (Hz) | 50/60 | 50/60 | 50/60 | 50/60 | 50/60 | 50/60 |
| Operating Range | +/- 10% | +/- 10% | +/- 10% | +/- 10% | +/- 10% | +/- 10% |
| Max. Power Consumption (W) | 1250/1415 | 1250/1415 | 806/957** | 2100/2427 | 1830/2130 | 910/1106** |
| Max. Nominal Current (A) | 11.2/12.3 | 5.6/7.0-6.2 | 3.1/3.2 | 16.1/21.0 | 9.1/10.6-9.5 | 3.6/3.5 |
| Starting Current (A) | 48 | 27 | 16 | 57 | 38 | 16 |
| Agency Approvals | UL/cUL Listed CE EAC Others available upon request | | | | | |
| Power Input Description | Terminal Block | | | | | |
| ENCLOSURE PROTECTION | | | | | | |
| UL Type | Type 12, 3R, 4 standard Type 4X Stainless steel optional | | | | | |
| International Rating | IP56 internal loop IP34 external loop | | | | | |
| CONTROLLER | | | | | | |
| Description | Basic mechanical thermostat with digital display | | | | | |
| Thermostat Location | Enclosure side on all base models | | | | | |
| Digital Display Location: | | | | | | |
| Indoor Models | Ambient side | | | | | |
| Outdoor Models | Enclosure side | | | | | |
| Factory Thermostat Setting (F/C) | 80/27 | | | | | |
| SOUND LEVEL | | | | | | |
| At 1.5 Meters | 68 dB(A) | | | | | |
| UNIT CONSTRUCTION | | | | | | |
| Material | Galvanized sheet metal standard Stainless steel optional | | | | | |
| Finish | RAL 7035 light-gray, semi-textured powder-coat paint standard Other colors available | | | | | |
| ACCESSORIES | | | | | | |
| Cleanable Re-usable Filter | Aluminum mesh Part #101000103 | | | | | |
| EASYSWAP Adaptor Plenum (GENESIS M52) | Enables SPECTRACOOL to be mounted to a GENESIS M52 air conditioner cutout Catalog Number PLM52G52 | | | | | |
| UNIT DIMENSIONS | | | | | | |
| Height (in./mm) | 52.69/1338 | | | | | |
| Width (in./mm) | 17.12/435 | | | | | |
| Depth (in./mm) | 11.66/296 | | | | | |
| Weight (lb./kg) | 128/58.1 | 128/58.1 | 138/62.6 | 131/59.4 | 131/59.4 | 141/64.0 |

*Units with Remote Access Control utilize a digital controller and communicate via EtherNet/IP, Profinet, Modbus TCP/IP and SNMP over ethernet or modbus RTU over USB.

**Watts based on .65 power factor.

Performance Curves for G52 Models 8000 BTU/Hr. (23 Watt)

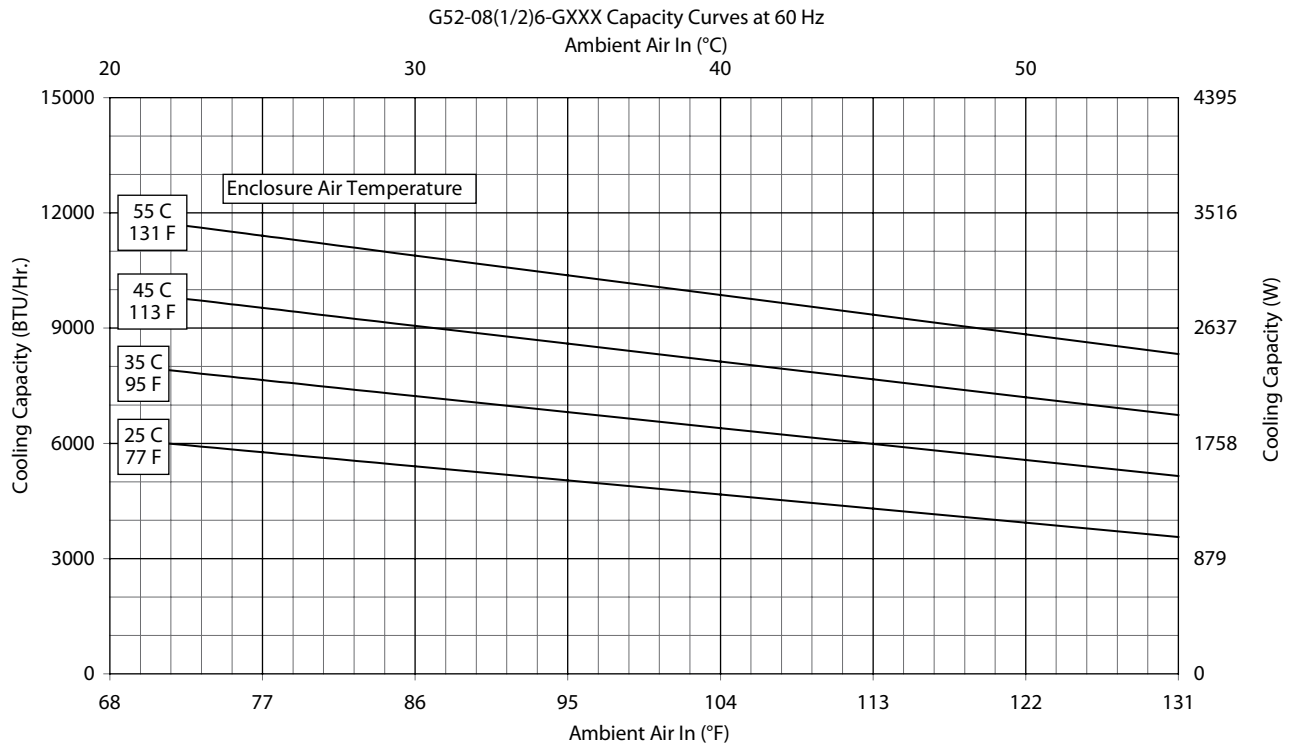
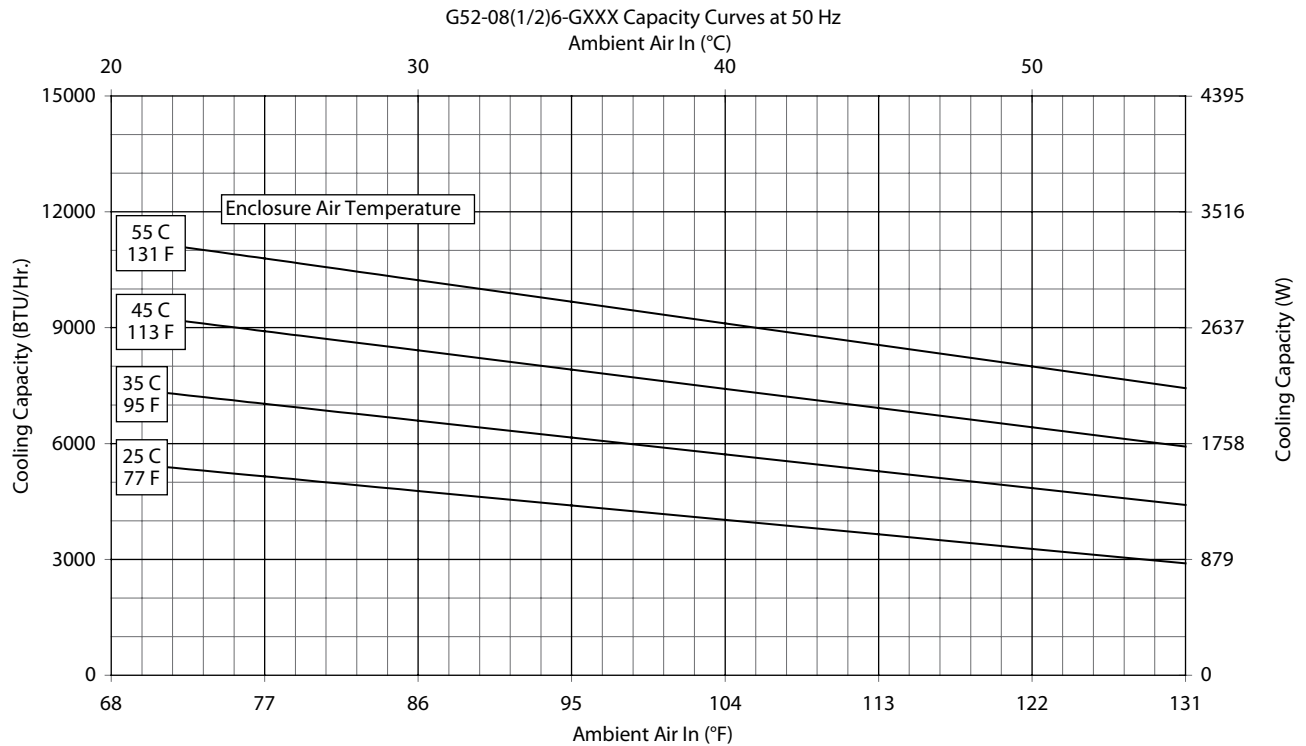

Performance Curves for G52 Models 8000 BTU/Hr. (2300 Watt)

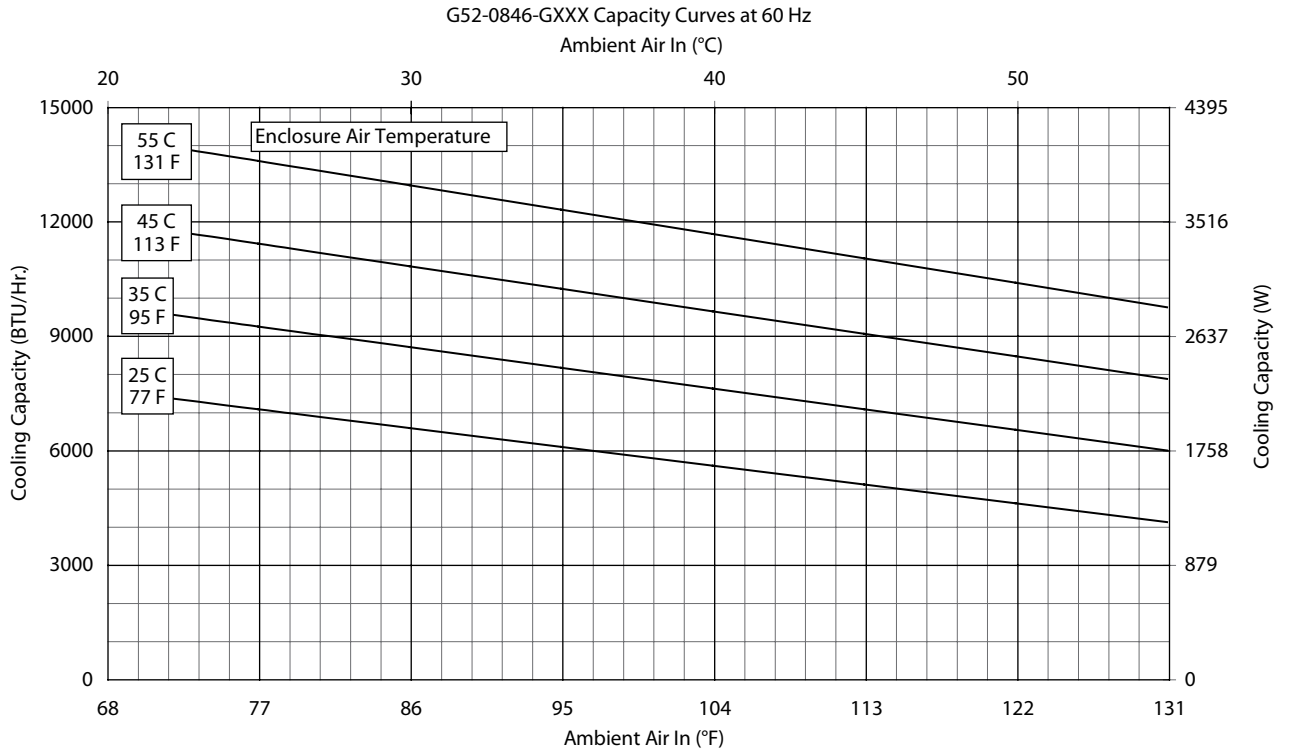
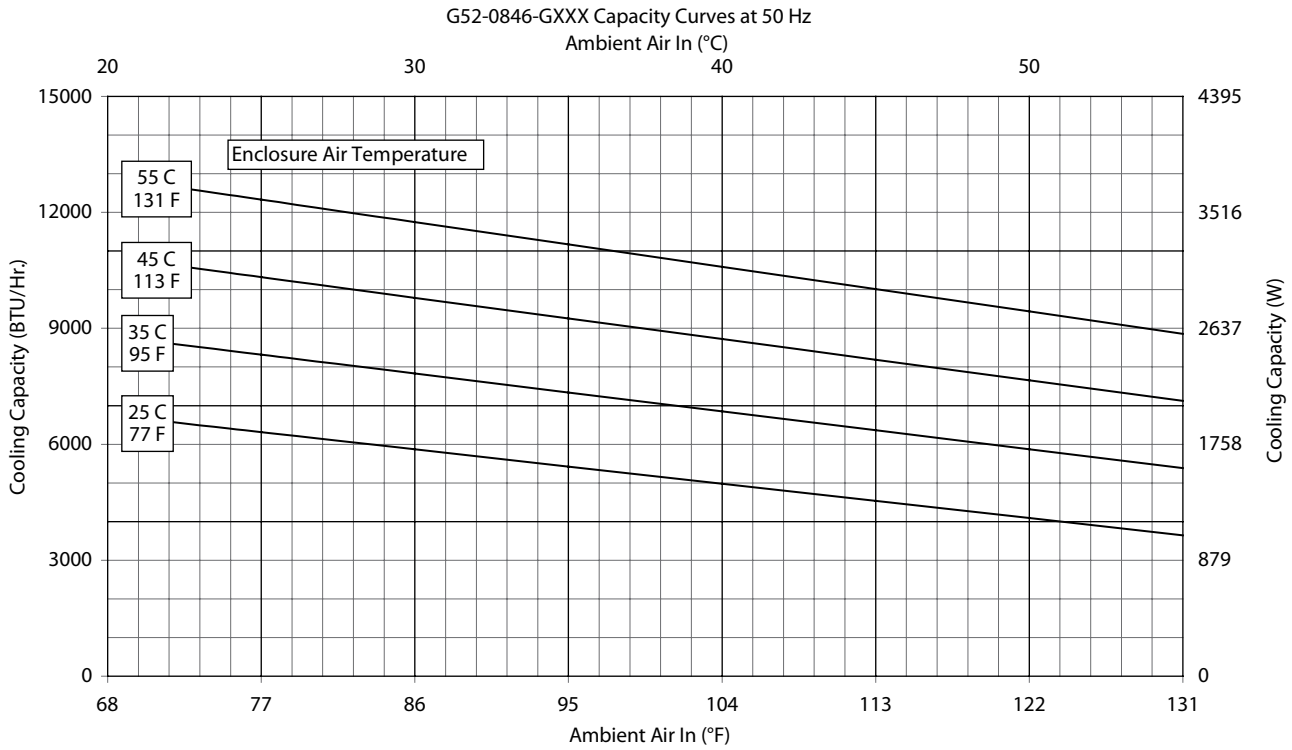

Performance Curves for G52 Models 12000 BTU/Hr. (3500 Watt)

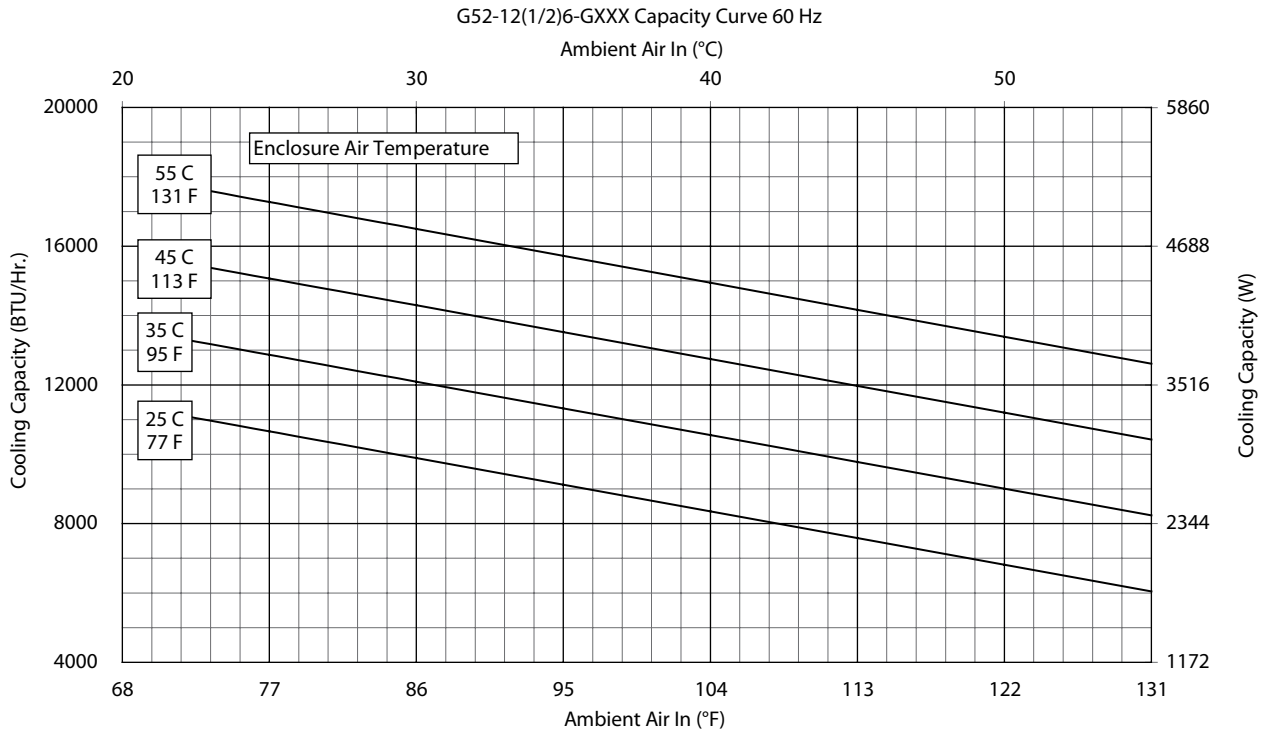
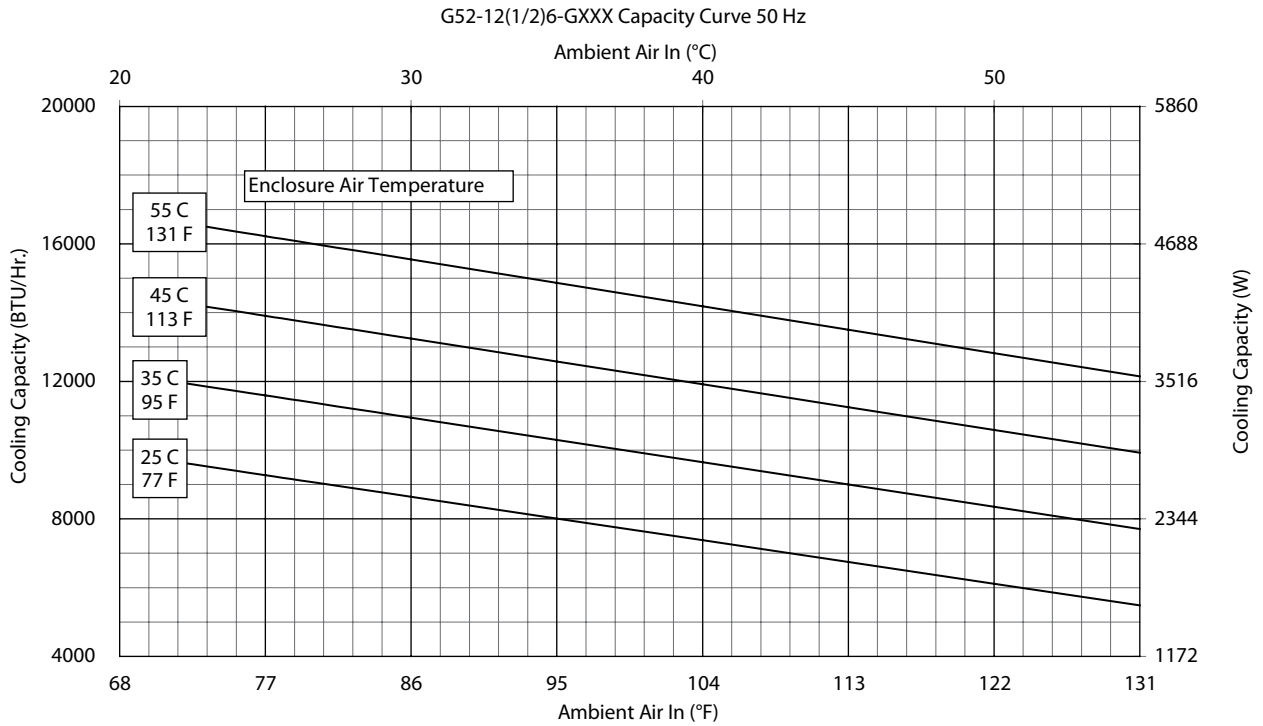

Performance Curves for G52 Models 12000 BTU/Hr. (3516 Watt)

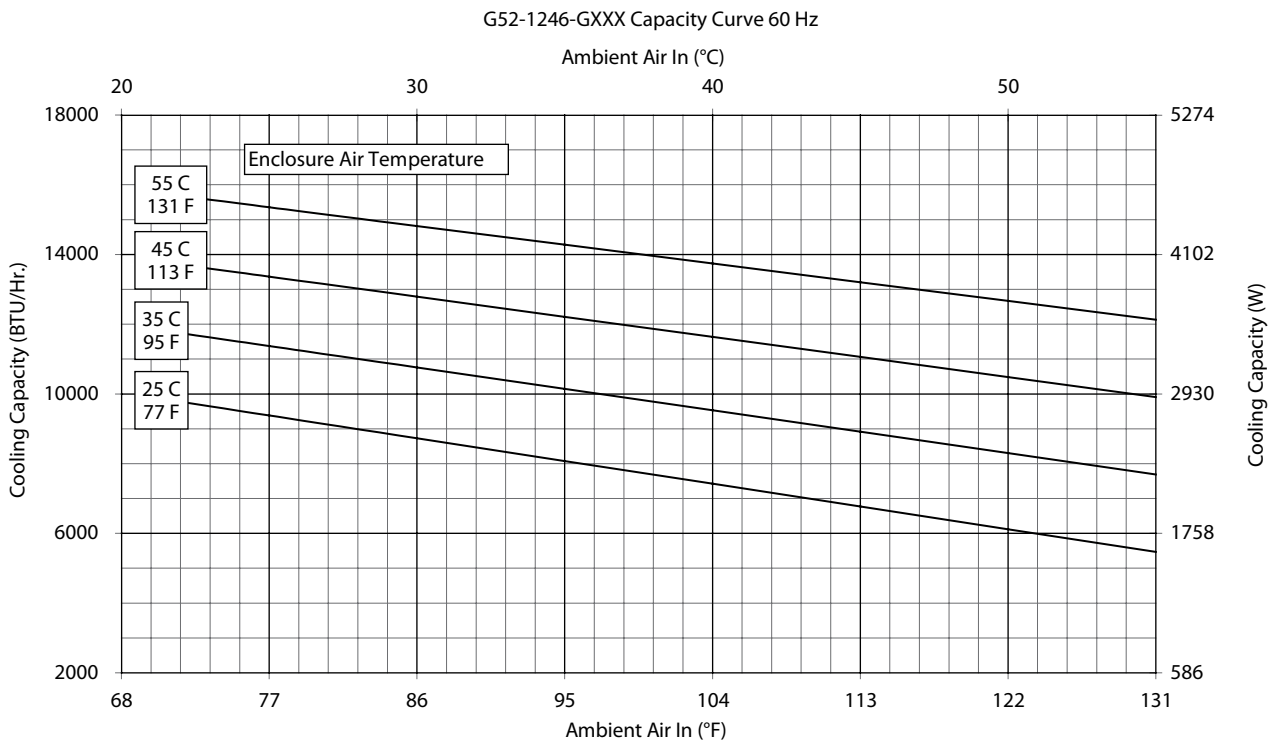
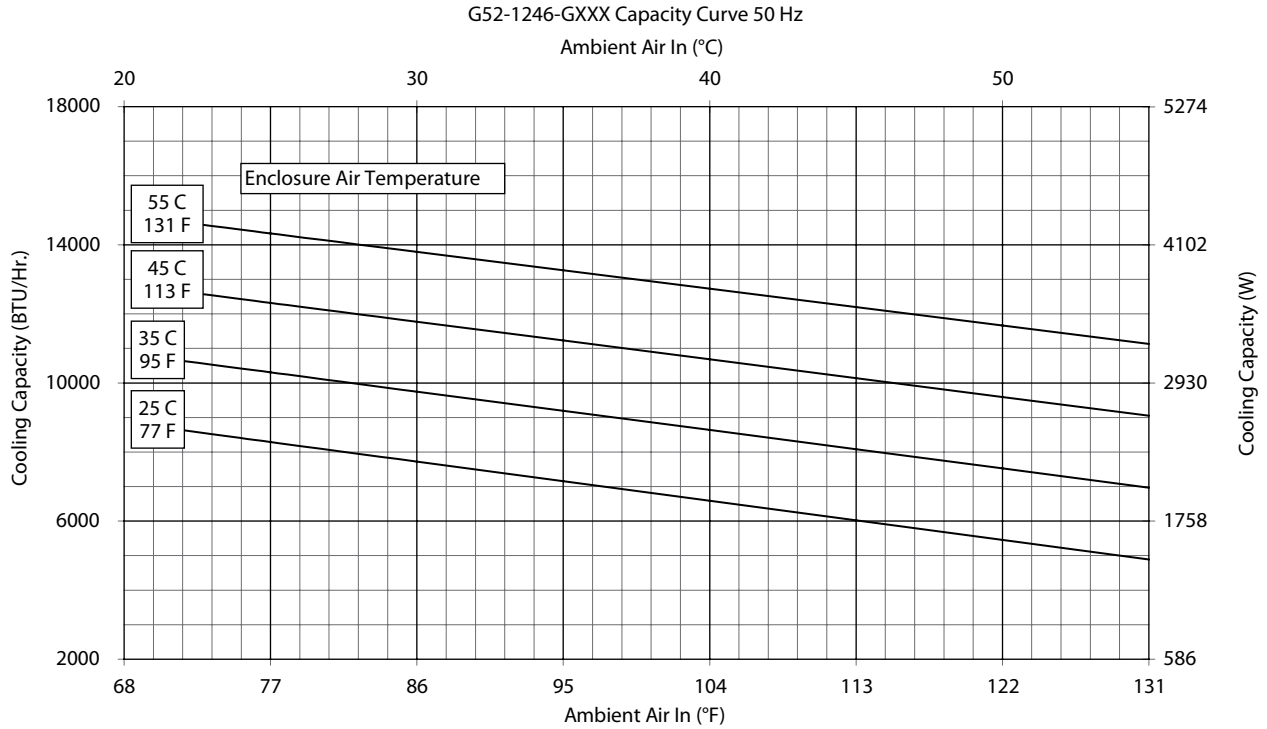

G52 Models 8000/12000 BTU/Hr. (2300/3500 Watt)

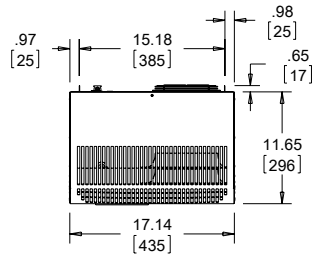

NOTE:
 1. MOUNTING GASKET SUPPLIED (NOT SHOWN)
 2. UNITS: in. [mm]

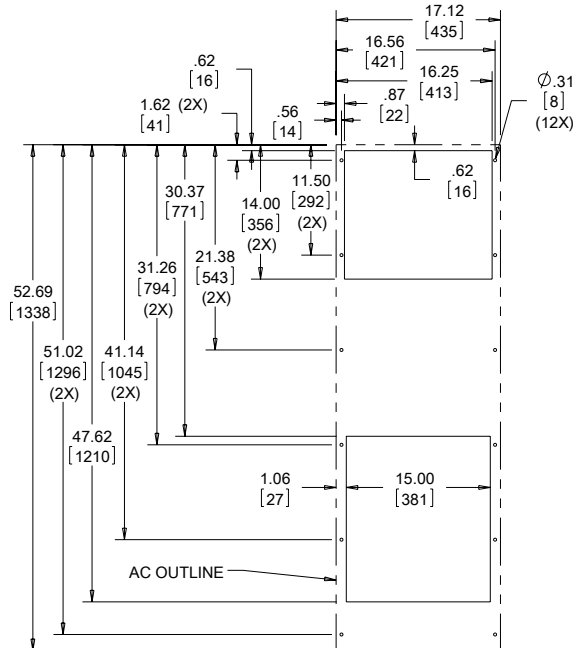
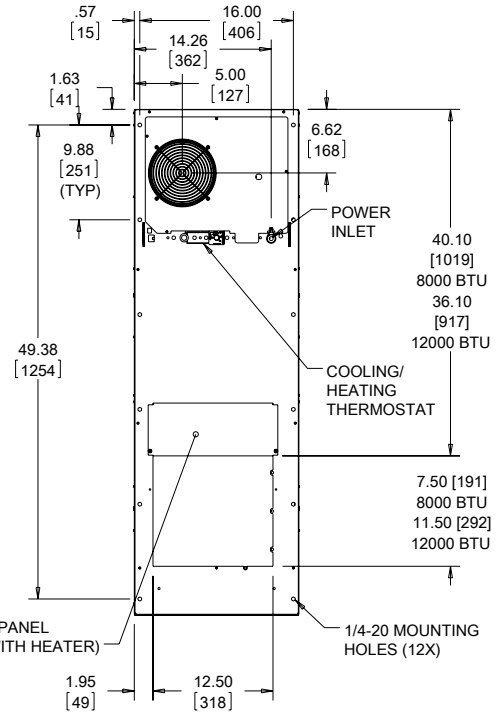
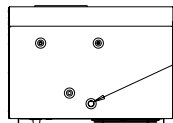
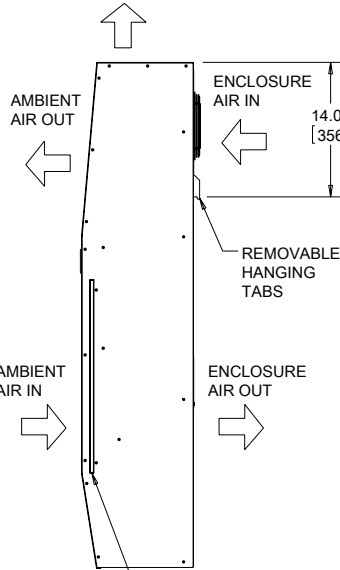
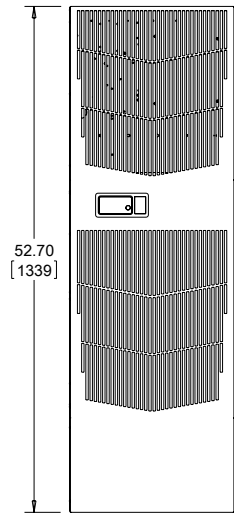

Cutout Dimensions (Standard)

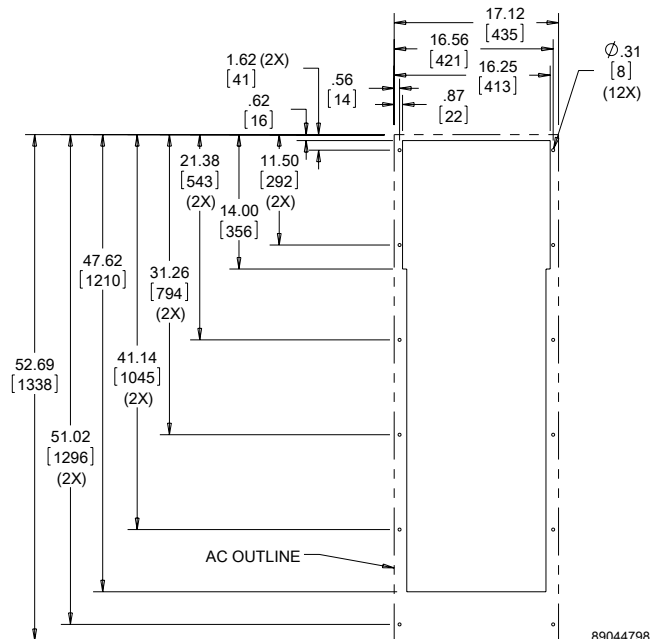

Cutout Dimensions (G520846G150, G520846G151, G521246G150, G521246G151 only)

Visit www.PentairProtect.com to download 2D and 3D CAD drawings into the overall design of your electrical system.

G52 Models 8000/12000 BTU/Hr. (2344/3516 Watt) with Partial Recess

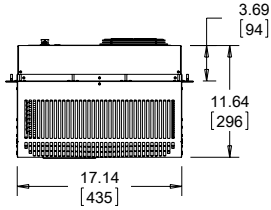

NOTE:
 1. MOUNTING GASKET SUPPLIED (NOT SHOWN)
 2. UNITS: in. [mm]

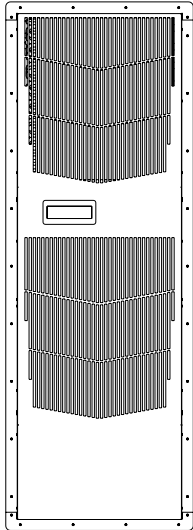

CLEANABLE, REUSABLE ALUMINUM INLET FILTER

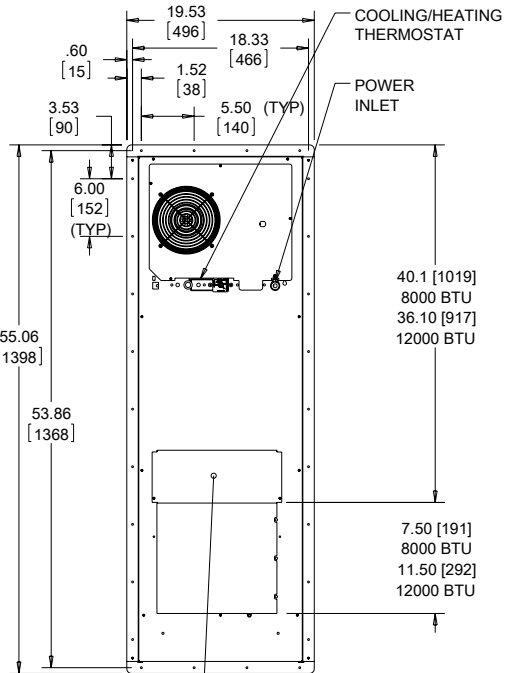
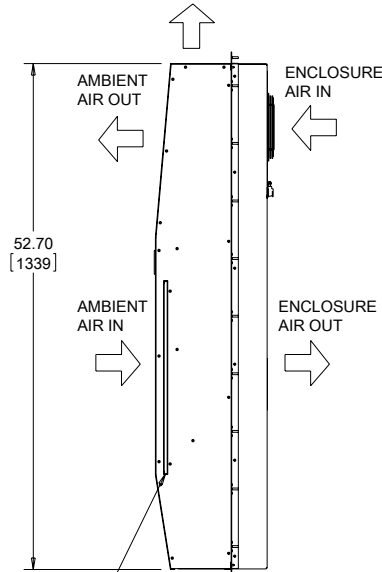

OPTIONAL ACCESS PANEL (ONLY FOR UNITS WITH HEATER)

INCLUDED MOUNTING GASKET KIT TO BE ADHERED TO THIS SIDE OF MOUNTING RAILS BEFORE INSTALLING AIR CONDITIONER TO CABINET

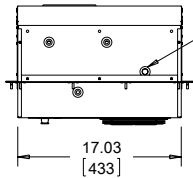

ACCESS HOLE TO .38 [9.5] OUTSIDE DIAMETER DRAIN STUB

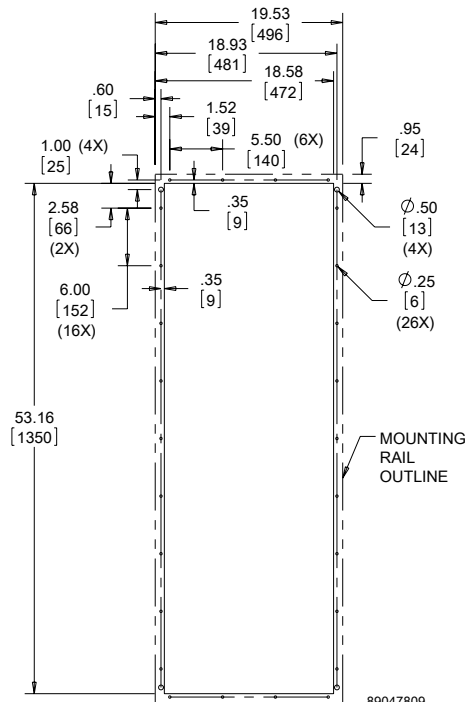

Cutout Dimensions

89047809

Visit www.PentairProtect.com to download 2D and 3D CAD drawings into the overall design of your electrical system.

Performance Data G57 Models 20000 BTU/Hr. (5861 Watt)

| CATALOG NUMBER | | |
|---|---|-------------------|
| Indoor Model | G572026G050 | G572046G050 |
| Indoor Model Stainless Steel Type 4X | G572026G051 | G572046G051 |
| Indoor Model with Remote Access Control* | G572026G060 | G572046G060 |
| Outdoor Model without Heat Pkg. | G572026G100 | G572046G100 |
| Outdoor Model Partial Recessed Mount | G572026G101 | G572046G101 |
| Outdoor Model with Heat Pkg. | G572026G150 | G572046G150 |
| Outdoor Model without Heat Pkg. Stainless Steel Type 4X | G572026G102 | G572046G102 |
| Outdoor Model with Heat Pkg. Stainless Steel Type 4X | G572026G151 | G572046G151 |
| COOLING PERFORMANCE | | |
| Nominal: | | |
| BTU/Hr. | 20000 | 20000 |
| Watts | 5861 | 5861 |
| At 131 F/131 F (55 C/55 C): | | |
| BTU/Hr. (50/60 Hz) | 17500/19600 | 21400/23400 |
| W (50/60 Hz) | 5129/5744 | 6272/6857 |
| At 95 F/95 F (35 C/35 C): | | |
| BTU/Hr. (50/60 Hz) | 16000/18000 | 19300/21400 |
| W (50/60 Hz) | 4689/5275 | 5656/6272 |
| Refrigerant | R407c | R407c |
| Refrigerant Charge (ounces/grams) | 50/1417 | 48/1361 |
| Operating Temperature Range: | | |
| Maximum (°F/°C) | 131/55 | 131/55 |
| Indoor Minimum (°F/°C) | 50/10 | 50/10 |
| Outdoor Minimum (°F/°C) | -40/-40 | -40/-40 |
| Airflow at 0 Static Pressure: | | |
| Internal loop 50 Hz (CFM / m ³ /hr.) | 513/872 | 513/872 |
| External loop 50 Hz (CFM / m ³ /hr.) | 919/1562 | 919/1562 |
| Internal loop 60 Hz (CFM / m ³ /hr.) | 587/998 | 587/998 |
| External loop 60 Hz (CFM / m ³ /hr.) | 1055/1794 | 1055/1794 |
| Max. Heater W (Outdoor Models) | 3000 | 3000 |
| ELECTRICAL DATA | | |
| Rated Voltage | 230/230 | 400/460 3~ |
| Frequency (Hz) | 50/60 | 50/60 |
| Operating Range | +/- 10% | +/- 10% |
| Max. Power Consumption (W at 50/60 Hz) | 4508/5106 | 2400/3128 |
| Max. Nominal Current (A at 50/60 Hz) | 19.6/22.2 | 6.0/6.8 |
| Starting Current (A) | 63 | 27 |
| Agency Approvals | UL/cUL Listed CE EAC Others available upon request | |
| Power Input Description | Terminal Block | |
| ENCLOSURE PROTECTION | | |
| UL Type | Type 12, 3R, 4 standard Type 4X stainless steel optional | |
| International Rating | IP56 internal loop IP34 external loop | |
| CONTROLLER | | |
| Description | Basic mechanical thermostat with digital display | |
| Thermostat Location | Enclosure side on all base models | |
| Digital Display Location: | | |
| Indoor Models | Ambient side | |
| Outdoor Models | Enclosure side | |
| Factory Thermostat Setting (°F/°C) | 80/27 | |
| SOUND LEVEL | | |
| At 1.5 Meters | 74.1 dB(A) | |
| UNIT CONSTRUCTION | | |
| Material | Galvanized sheet metal standard Stainless steel optional | |
| Finish | RAL 7035 light-gray, semi-textured powder-coat paint standard | |
| ACCESSORIES | | |
| Cleanable Re-usable Filter | Aluminum mesh part #101000103 BA | |
| EASYSWAP Adaptor Plenum (T-Series T53) | Enables SPECTRACOOL to be mounted to a T-Series T53 air conditioner cutout part #57721601SP | |
| UNIT DIMENSIONS | | |
| Height (in./mm) | 57.69/1465.4 | |
| Width (in./mm) | 20.87/530.1 | |
| Depth (in./mm) | 15.28/388.1 | |
| Weight (lb./kg) | 197/89 | |

*Units with Remote Access Control utilize a digital controller and communicate via EtherNet/IP, Profinet, Modbus TCP/IP and SNMP over ethernet or modbus RTU over USB.

Performance Curves for G57 Models 20000 BTU/Hr.

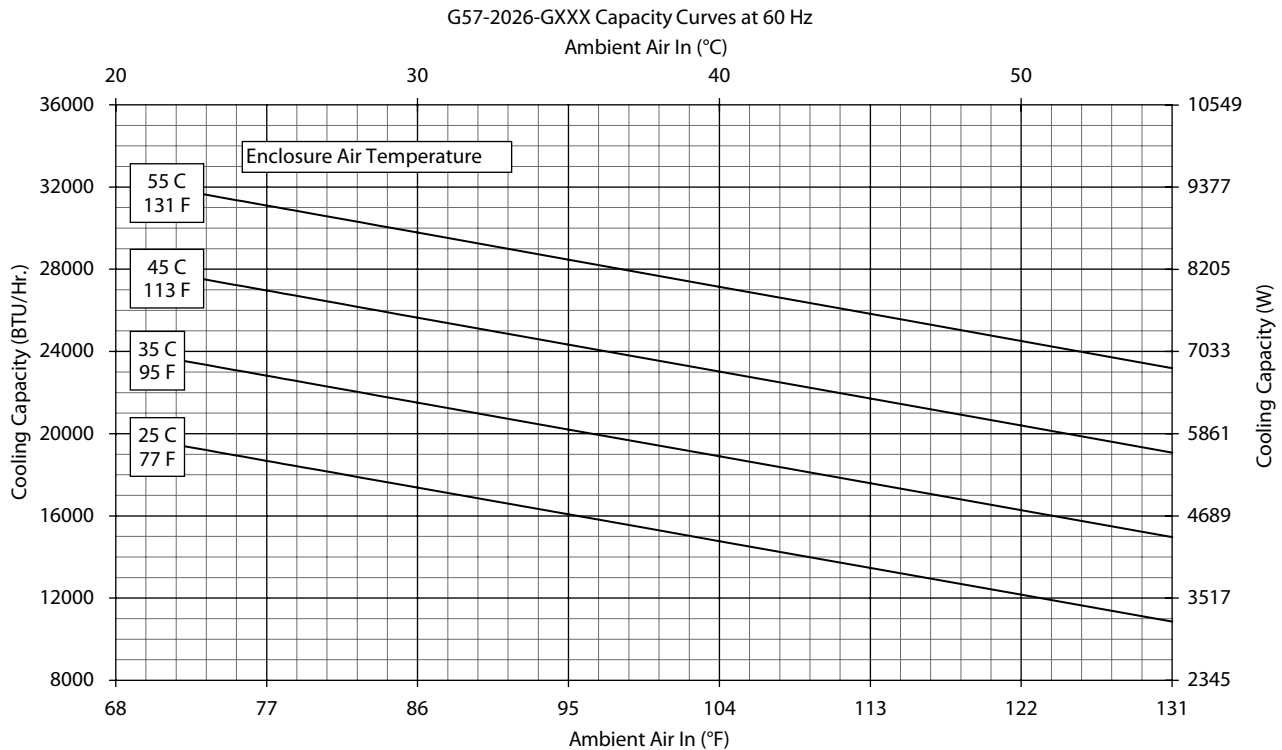
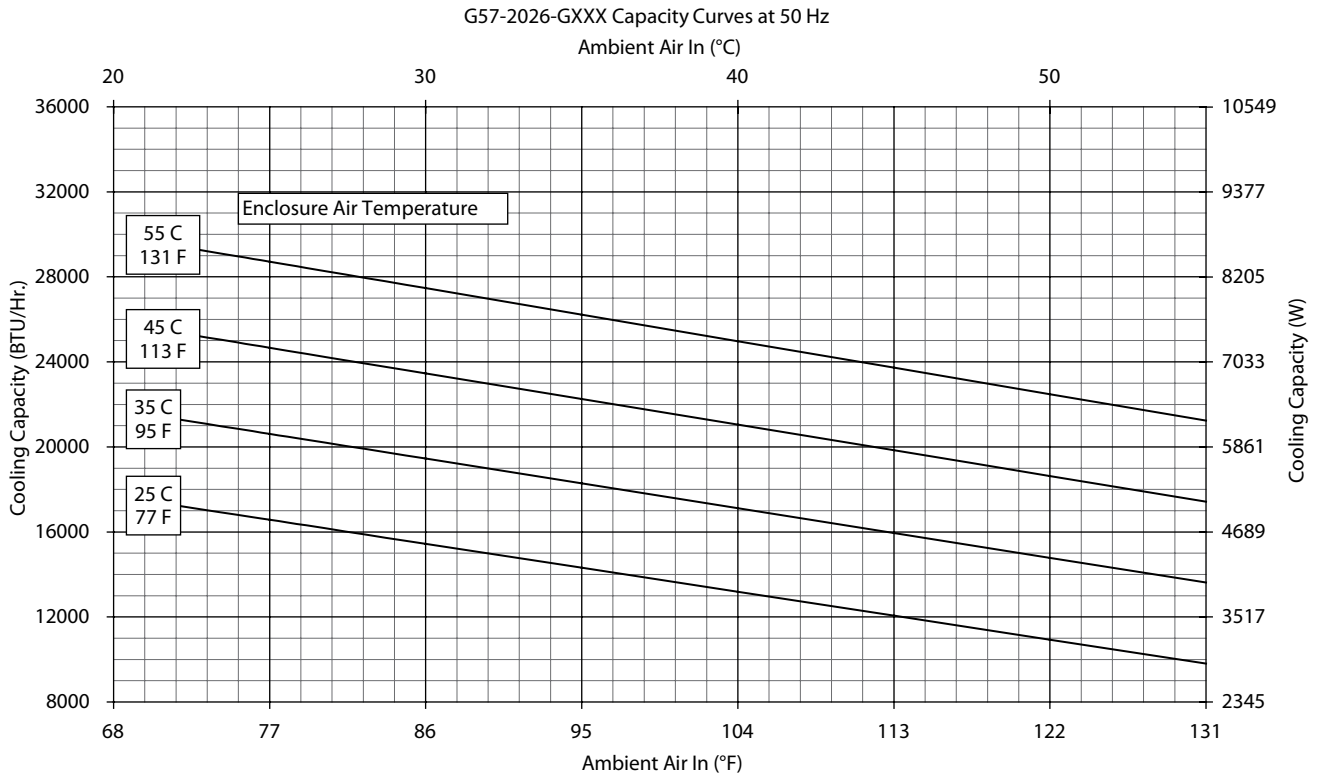

Performance Curves for G57 Models 20000 BTU/Hr.

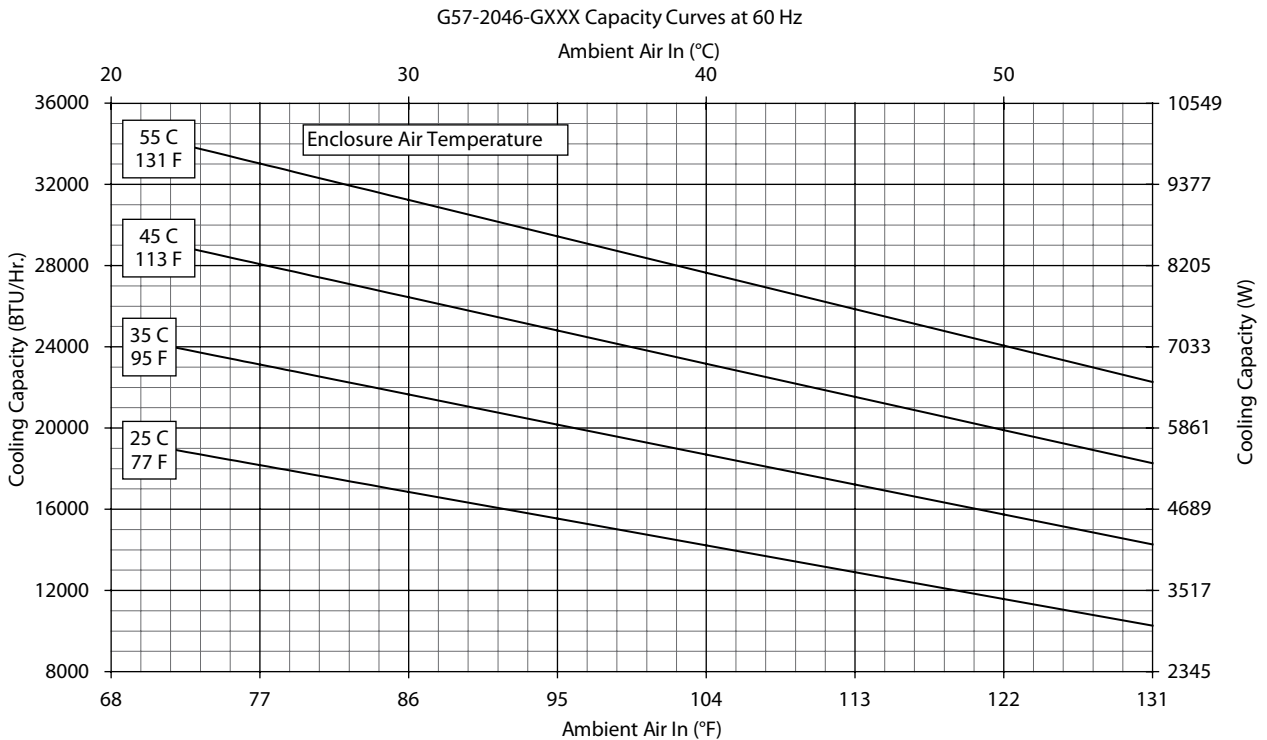
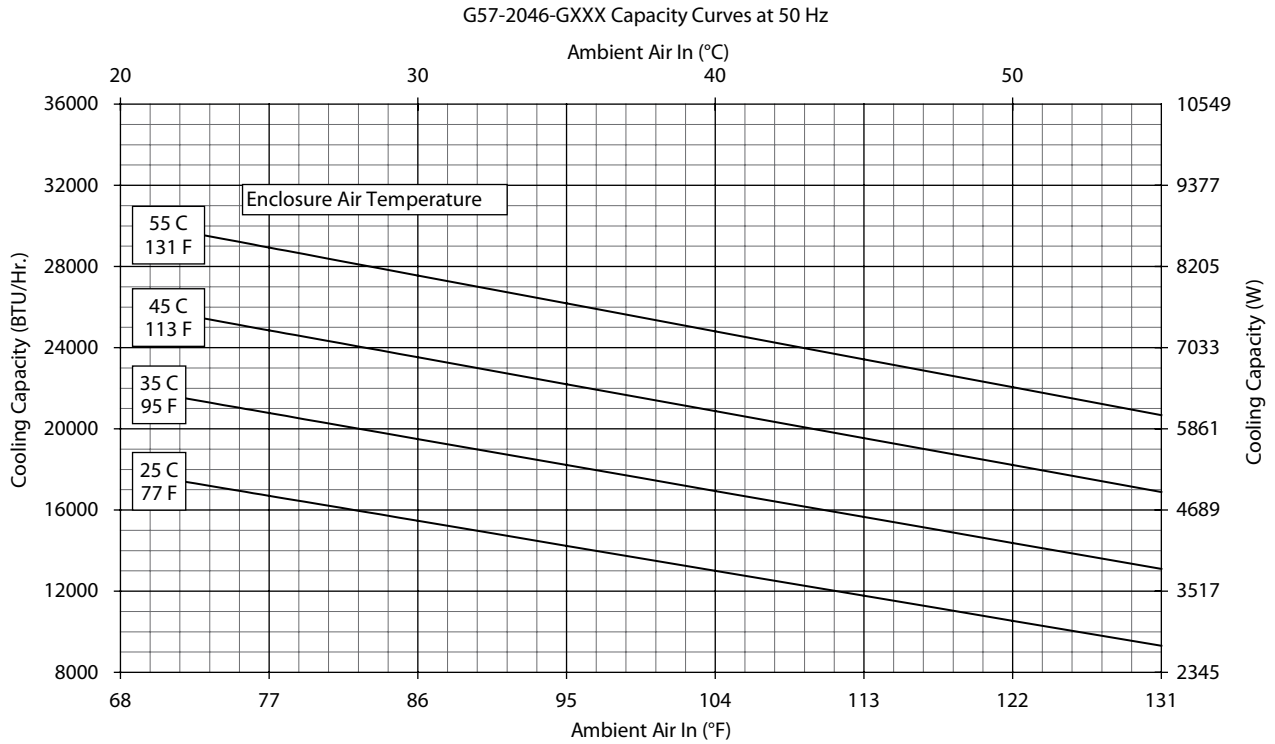

G57 Models 20000 BTU/Hr. (5861 Watt)

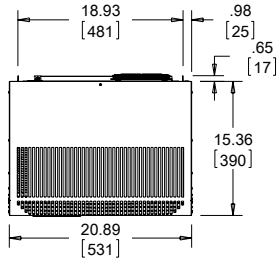

NOTE:
1. MOUNTING GASKET SUPPLIED (NOT SHOWN)
2. UNITS: in. [mm]

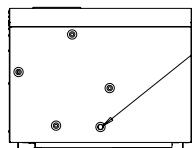
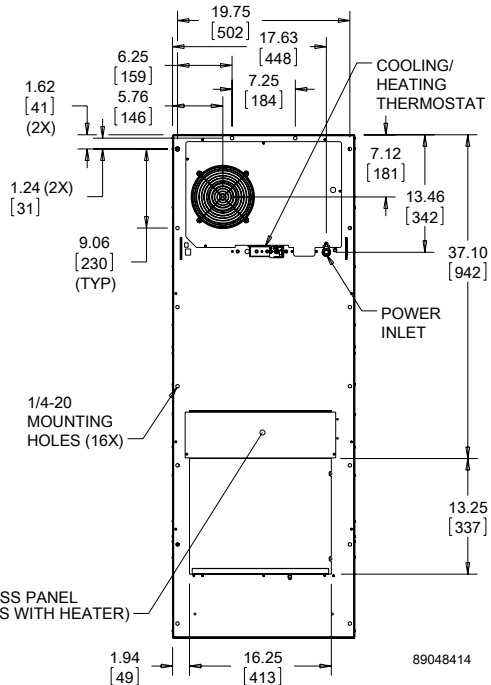
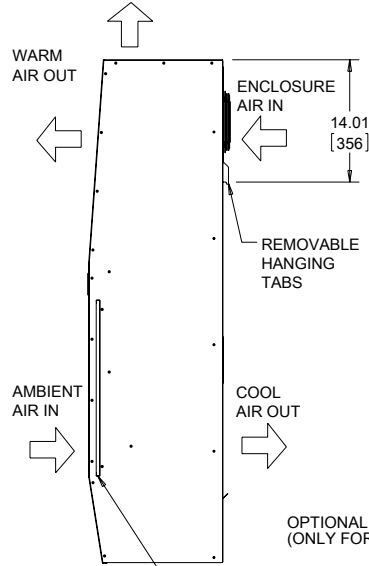
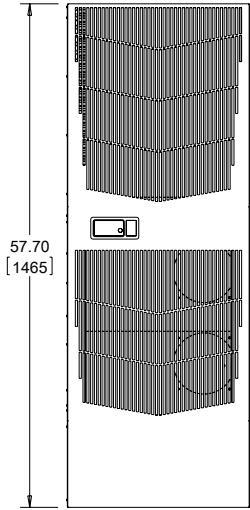

CLEANABLE, REUSABLE, ALUMINUM INLET FILTER

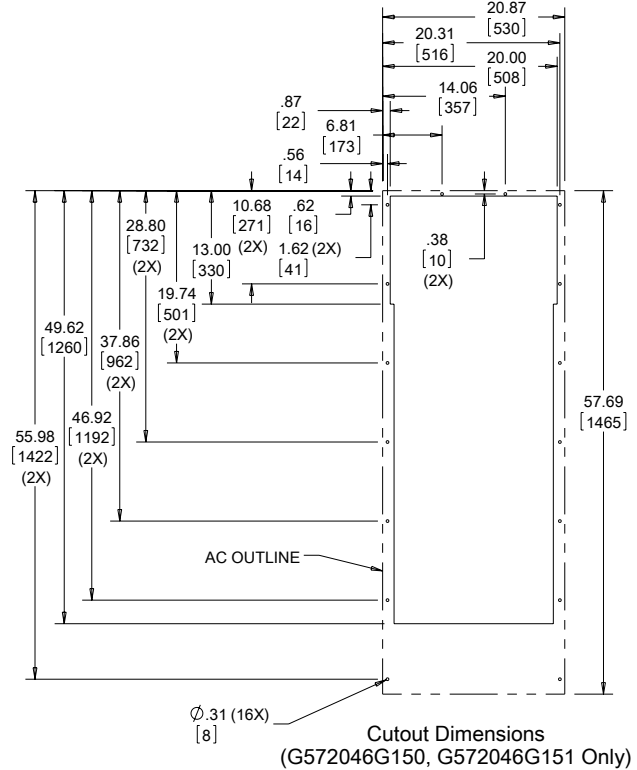
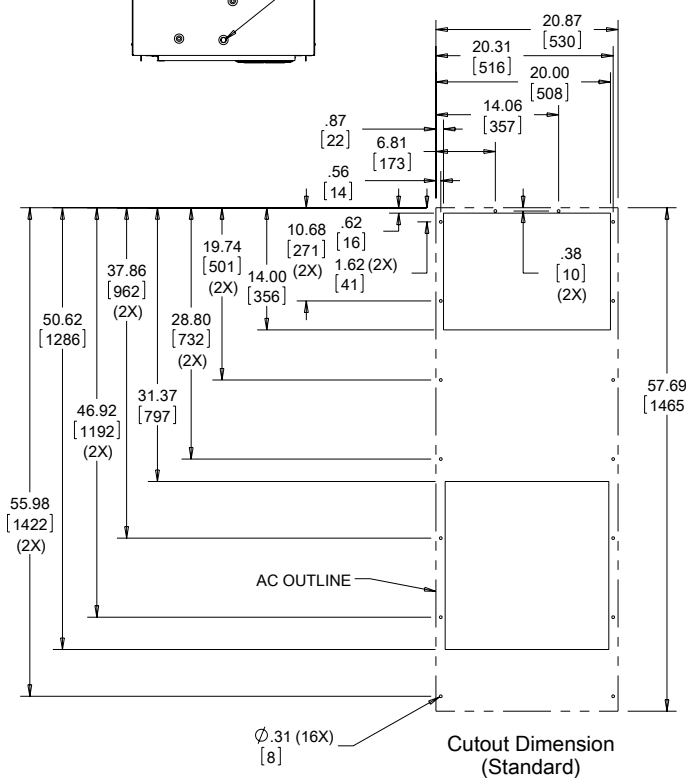

Visit www.PentairProtect.com to download 2D and 3D CAD drawings into the overall design of your electrical system.

G57 Models 20000 BTU/Hr. (5861 Watt) With Partial Recess

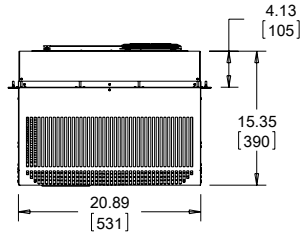

NOTE:
 1. MOUNTING GASKET SUPPLIED (NOT SHOWN)
 2. UNITS: in. [mm]

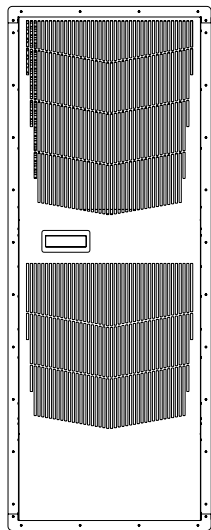

CLEANABLE, REUSABLE, ALUMINUM INLET FILTER

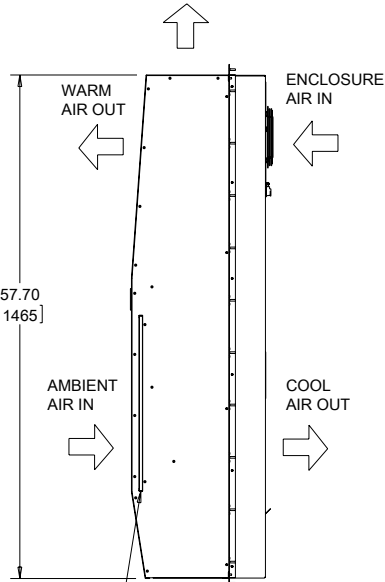

INCLUDED MOUNTING GASKET KIT TO BE ADHERED TO THIS SIDE OF MOUNTING RAILS BEFORE INSTALLING AIR CONDITIONER TO CABINET

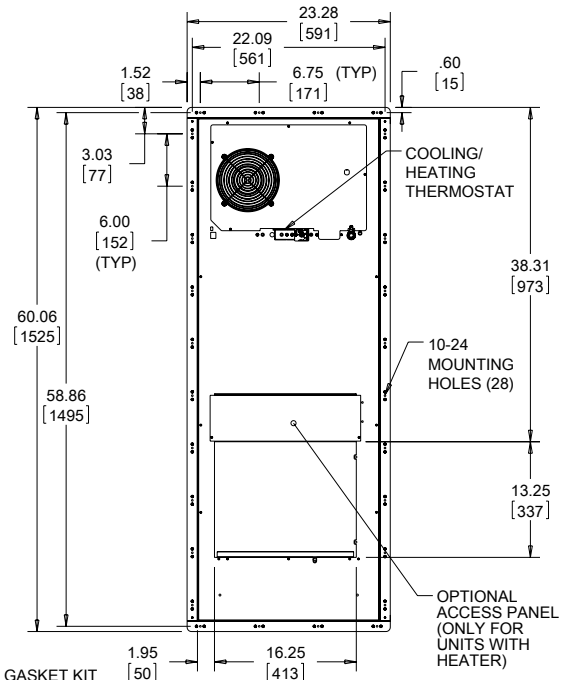

COOLING/ HEATING THERMOSTAT

10-24 MOUNTING HOLES (28)

OPTIONAL ACCESS PANEL (ONLY FOR UNITS WITH HEATER)

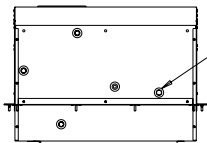

ACCESS HOLE TO .38 [9.5] OUTSIDE DIAMETER DRAIN STUB

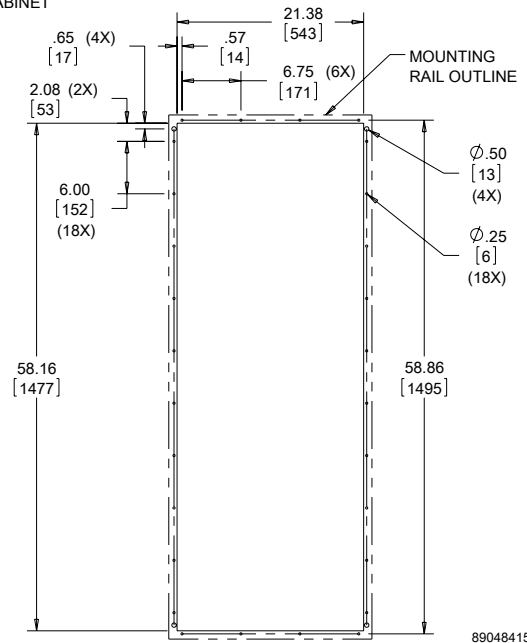

Cutout Dimensions

89048415

Visit www.PentairProtect.com to download 2D and 3D CAD drawings into the overall design of your electrical system.

Notes