

Super Capacitors

Super Capacit



- All specifications in this catalog and production status of products are subject to change without notice. Prior to the purchase, please contact NEC TOKIN for updated product data.
- Please request for a specification sheet for detailed product data prior to the purchase.
- Before using the product in this catalog, please read "Precautions" and other safety precautions listed in the printed version catalog.

FOR CORRECT USE OF SUPER CAPACITORS

1. Please confirm the operating conditions and the specifications of the Super Capacitors before using them.
2. The electrolyte of these Super Capacitors is sealed with material such as rubber. When you use the capacitors for a long time at high temperature, the moisture of the electrolyte evaporates and the equivalent series resistance (E.S.R.) increases. The fundamental failure mode is the open mode depending on E.S.R. increase.
When using a capacitor, please introduce a safe design assuming unexpected capacitor failure, such as redundancy in design and protection from fire and erroneous operation.
3. Please read 'Notes on Using the Super Capacitor' on page 60 when you design the circuits using the Super Capacitors.



- All specifications in this catalog and production status of products are subject to change without notice. Prior to the purchase, please contact NEC TOKIN for updated product data.
- Please request for a specification sheet for detailed product data prior to the purchase.
- Before using the product in this catalog, please read "Precautions" and other safety precautions listed in the printed version catalog.

CONTENTS

	page
1. Organization of Super Capacitor Series	4
2. Performance for Selection	5
3. Characteristics of Super Capacitor	5
4. Typical Applications	6
5. Part Number System	7
6. Rated Specifications	9
6.1 FC Series (SMD Type)	9
6.2 FM Series	13
6.3 FG Series	20
6.4 FT Series	22
6.5 FY Series	24
6.6 FR Series	26
6.7 FS Series	28
6.8 FA, FE Series	30
6.9 HV Series (High Capacitance Type)	32
7. Packing	34
8. List of Plating Type and Sleeve Type	35
9. Measurement Conditions	36
10. Notes on Using Super Capacitor (Electric Double-Layer Capacitor)	38



- All specifications in this catalog and production status of products are subject to change without notice. Prior to the purchase, please contact NEC TOKIN for updated product data.
- Please request for a specification sheet for detailed product data prior to the purchase.
- Before using the product in this catalog, please read "Precautions" and other safety precautions listed in the printed version catalog.

1. Organization of Super Capacitor Series

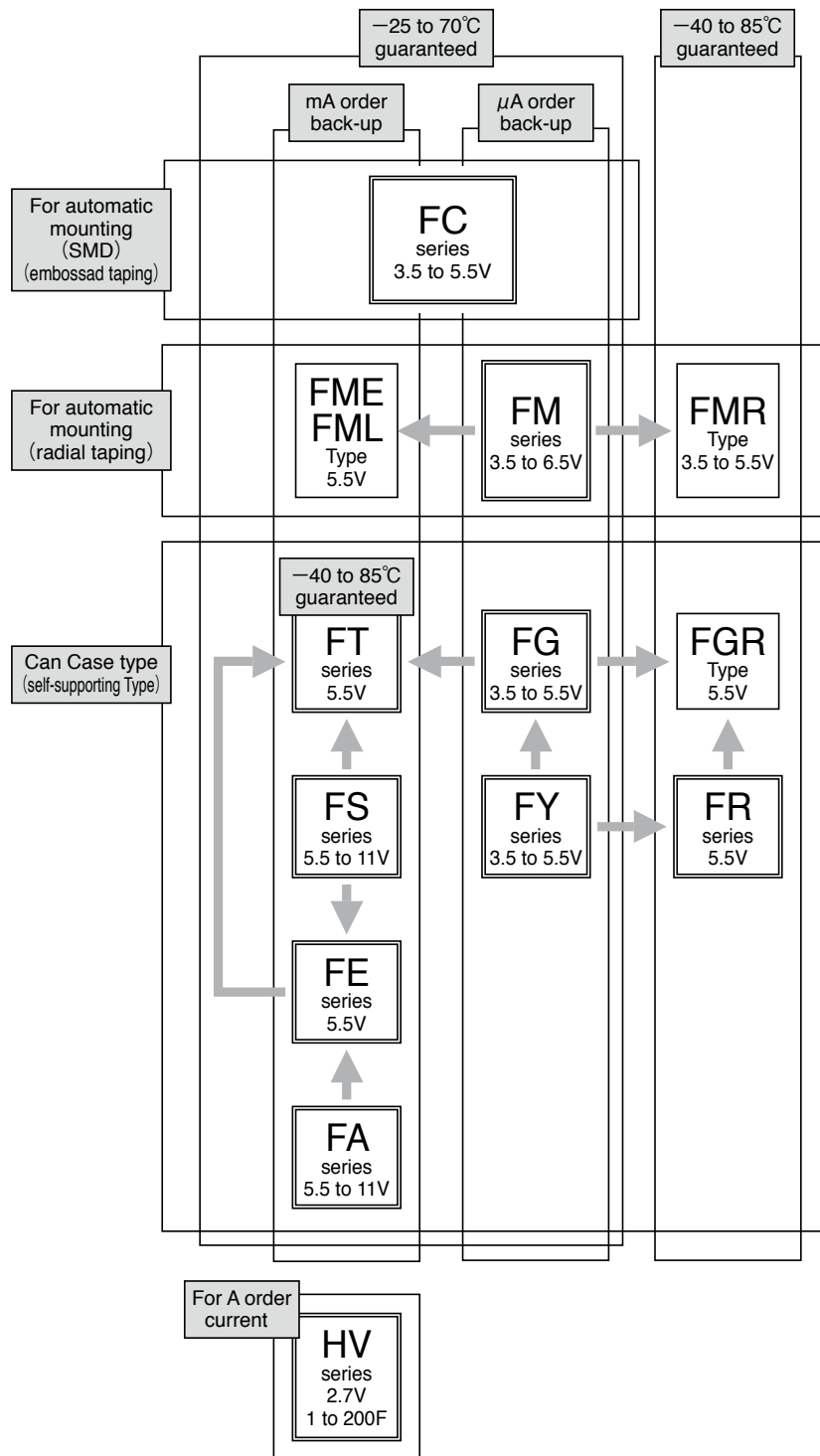

- All specifications in this catalog and production status of products are subject to change without notice. Prior to the purchase, please contact NEC TOKIN for updated product data.
- Please request for a specification sheet for detailed product data prior to the purchase.
- Before using the product in this catalog, please read "Precautions" and other safety precautions listed in the printed version catalog.

2. Performance for Selection

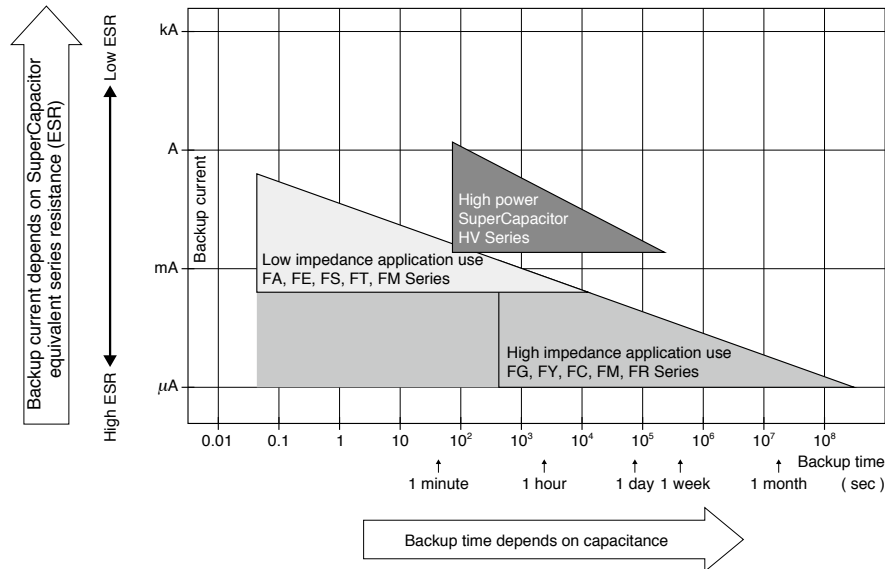

3. Characteristics of Super Capacitor

Super Capacitor can not be used for applications in AC circuit such as ripple absorption because it has high internal resistance (several hundred $\text{m}\Omega$ to a hundred Ω) compared to aluminum electrolysis capacitor. Thus its main use would be similar to that of secondary battery such as power back-up in DC circuit. The following list shows the characteristics of Super Capacitors as compared to aluminum electrolyses capacitors for power back-up and secondary batteries.

	Secondary battery		Capacitor	
	NiCd battery	Lithium ion battery	Aluminum electrolysis capactio	Super Capacitor
Back-up ability	◎	◎	△	○
Eco-hazard	Cd	—	—	—
Operating temperature range	-20 to 60 °C	-20 to 50 °C	-55 to 105 °C	-40 to 85 °C (FR, FT)
Charge time	few hours	few hours	few minutes	few minutes
Charge/discharge life time	approx. 500 times	approx. 500 to 1000 times	limitless (*1)	limitless (*1)
Restrictions on charge/discharge	yes	yes	none	none
Flow soldering	not applicable	not applicable	applicable	applicable
Automatic mounting	not applicable	not applicable	applicable	applicable (FM and FC series)
Safety risks	leakage, explosion	leakage, combustion, explosion, ignition	heat-up, explosion	gas emission (*2)

(*1) Aluminum electrolysis capacitor and Super Capacitor has limited lifetime. However, when used under proper conditions, both can operate sufficiently within the designed lifetime of the set they are built in.

(*2) There is no harm as it is a mere leak of water vapor which transitioned from water contained in the electrolyte (diluted sulfuric acid). However, application of abnormal voltage surge exceeding maximum operating voltage may result in leakage and explosion.



- All specifications in this catalog and production status of products are subject to change without notice. Prior to the purchase, please contact NEC TOKIN for updated product data.
- Please request for a specification sheet for detailed product data prior to the purchase.
- Before using the product in this catalog, please read "Precautions" and other safety precautions listed in the printed version catalog.

4. Typical Applications

As in the characteristics remarked previously, Super Capacitor has characteristics intermediate between general capacitors and batteries. Because of this, Super Capacitor can be used like a secondary battery when applied to DC circuit. The best suited applications of Super Capacitor are back-up device for the power shut-down of micro computers and RAM's. The list below shows main application examples.

Application Examples of Super Capacitor

Intended use (guideline)	Power supply (guideline)	Application	Examples of equipments	Series
Long time back-up	500 μ A and below	• CMOS RAM, IC for clocks	• Measuring device, Control equipment, Communication device, Automotive power source	• FR series (85°C guaranteed)
		• CMOS micro computer, IC for clocks	• CMOS micro computer • Static RAM/DTS (digital tuning system)	• FC series • FG series • FY series • FM series
Back-up for 1 hour or less	50 mA and below	• Micro computer, RAM	• VCR, Microwave oven, • Micro computer • Memory equipped device	• FT series • FS series
		• Driving motor	• VCR, Printer, Projector • Video disk	
		• Subsidiary power supply for driving motor during voltage drop	• Camera	
Back-up for 10 seconds or less	1 A and below	• Power source of toys, LED, buzzer	• Toys, Display device, Alarm device	• FA series • FE series
		• High current supply for a short amount of time	• Actuator, Relay solenoid, Gas igniter	
Power assist	Up to several A	• Power supply, Subsidiary power supply	• Street sign, Display light , UPS	• HV series



- All specifications in this catalog and production status of products are subject to change without notice. Prior to the purchase, please contact NEC TOKIN for updated product data.
- Please request for a specification sheet for detailed product data prior to the purchase.
- Before using the product in this catalog, please read "Precautions" and other safety precautions listed in the printed version catalog.

5. Part Number System

FM, FC, FT, FG, FS, FR, FY, FE, FA Series

FG Series bulk type

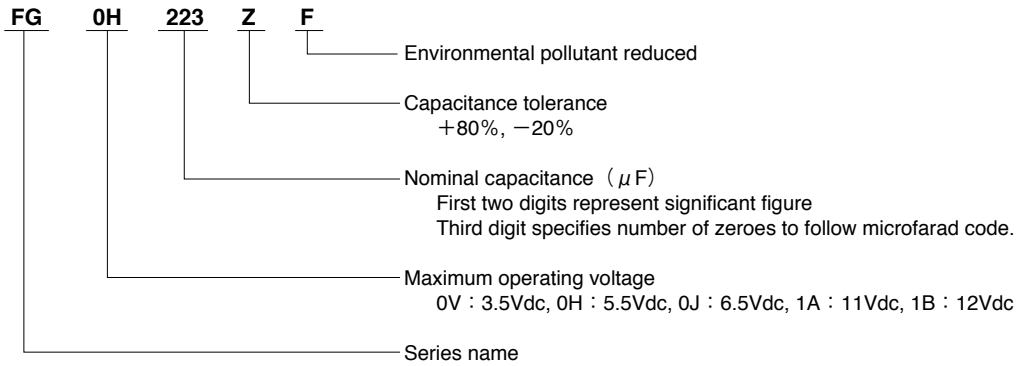

FM Series tape type (Ammo pack)

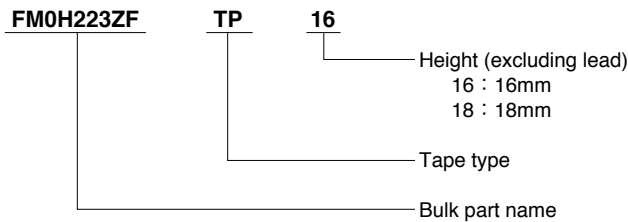

FC Series tape type (Embossed tape)

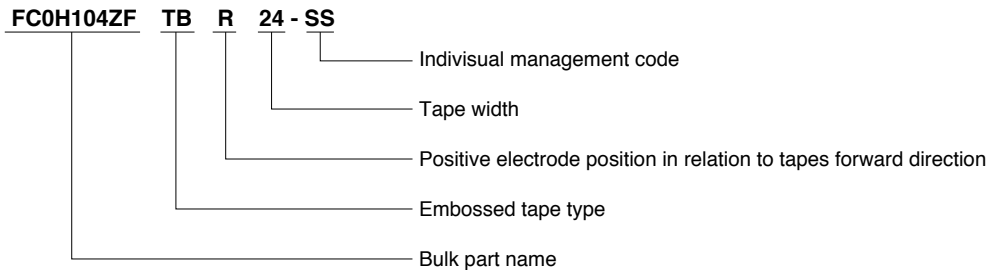

- All specifications in this catalog and production status of products are subject to change without notice. Prior to the purchase, please contact NEC TOKIN for updated product data.
- Please request for a specification sheet for detailed product data prior to the purchase.
- Before using the product in this catalog, please read "Precautions" and other safety precautions listed in the printed version catalog.

HV Series (HVZ Type)

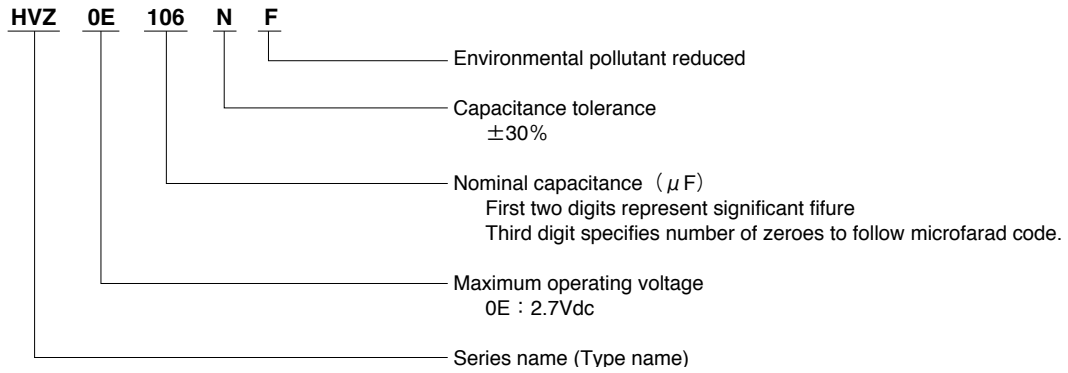

8 Super Capacitors Vol.13



- All specifications in this catalog and production status of products are subject to change without notice. Prior to the purchase, please contact NEC TOKIN for updated product data.
- Please request for a specification sheet for detailed product data prior to the purchase.
- Before using the product in this catalog, please read "Precautions" and other safety precautions listed in the printed version catalog.

6. Rated Specifications

6.1 FC Series

Features

- Enables surface mounting.
- High rated voltage of 5.5V.
- High leakage reliability.

Dimensions

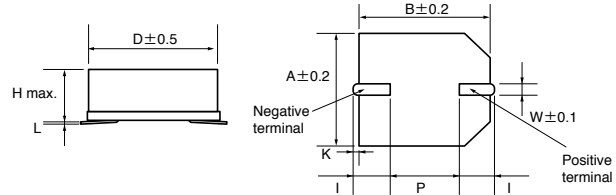

Markings

Displays nominal capacitance, MAX operating voltage serial number, polarity and etc.

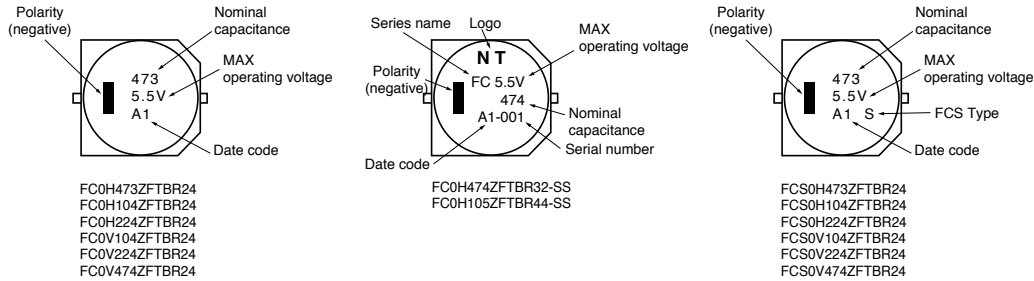

Standard models

● FC Type

Part Number	Max. Operating Voltage (Vdc)	Nominal Capacitance Discharge system (F)	Max. ESR (at 1kHz) (Ω)	Max. current at 30 minutes (mA)	Voltage Holding Characteristic Min. (V)	Dimension (Unit:mm)										Weight (g)
						D	H	A	B	I	W	P	K	L		
FC0H473ZFTBR24	5.5	0.047	50	0.071	4.2	10.5	5.5	10.8	10.8	3.6±0.5	1.2	5.0	0.7±0.3	0 ^{+0.3} _{-0.1}	1.0	
FC0H104ZFTBR24	5.5	0.10	25	0.15	4.2	10.5	5.5	10.8	10.8	3.6±0.5	1.2	5.0	0.7±0.3	0 ^{+0.3} _{-0.1}	1.0	
FC0H224ZFTBR24	5.5	0.22	25	0.33	4.2	10.5	8.5	10.8	10.8	3.6±0.5	1.2	5.0	0.7±0.3	0 ^{+0.3} _{-0.1}	1.4	
FC0H474ZFTBR32-SS	5.5	0.47	13	0.71	4.2	16.0	9.5	16.3	16.3	6.8±1.0	1.2	5.0	1.2±0.5	0 ^{+0.5} _{-0.1}	4.0	
FC0H105ZFTBR44-SS	5.5	1.0	7	1.50	4.2	21.0	10.5	21.6	21.6	7.0±1.0	1.4	10.0	1.2±0.5	0 ^{+0.5} _{-0.1}	6.7	
FC0V104ZFTBR24	3.5	0.10	50	0.09	—	10.5	5.5	10.8	10.8	3.6±0.5	1.2	5.0	0.7±0.3	0 ^{+0.3} _{-0.1}	1.0	
FC0V224ZFTBR24	3.5	0.22	25	0.20	—	10.5	5.5	10.8	10.8	3.6±0.5	1.2	5.0	0.7±0.3	0 ^{+0.3} _{-0.1}	1.0	
FC0V474ZFTBR24	3.5	0.47	25	0.42	—	10.5	8.5	10.8	10.8	3.6±0.5	1.2	5.0	0.7±0.3	0 ^{+0.3} _{-0.1}	1.4	

● FCS Type

Part Number	Max. Operating Voltage (Vdc)	Nominal Capacitance Discharge system (F)	Max. ESR (at 1kHz) (Ω)	Max. current at 30 minutes (mA)	Voltage Holding Characteristic Min. (V)	Dimension (Unit:mm)										Weight (g)
						D	H	A	B	I	W	P	K	L		
FCS0H473ZFTBR24	5.5	0.047	100	0.071	4.2	10.7	5.5	10.8	10.8	3.9±0.5	1.2	5.0	0.9±0.3	0 ^{+0.3} _{-0.1}	1.0	
FCS0H104ZFTBR24	5.5	0.10	50	0.15	4.2	10.7	5.5	10.8	10.8	3.9±0.5	1.2	5.0	0.9±0.3	0 ^{+0.3} _{-0.1}	1.0	
FCS0H224ZFTBR24	5.5	0.22	50	0.33	4.2	10.7	8.5	10.8	10.8	3.9±0.5	1.2	5.0	0.9±0.3	0 ^{+0.3} _{-0.1}	1.4	
FCS0V104ZFTBR24	3.5	0.10	100	0.09	—	10.7	5.5	10.8	10.8	3.9±0.5	1.2	5.0	0.9±0.3	0 ^{+0.3} _{-0.1}	1.0	
FCS0V224ZFTBR24	3.5	0.22	50	0.20	—	10.7	5.5	10.8	10.8	3.9±0.5	1.2	5.0	0.9±0.3	0 ^{+0.3} _{-0.1}	1.0	
FCS0V474ZFTBR24	3.5	0.47	50	0.42	—	10.7	8.5	10.8	10.8	3.9±0.5	1.2	5.0	0.9±0.3	0 ^{+0.3} _{-0.1}	1.4	



- All specifications in this catalog and production status of products are subject to change without notice. Prior to the purchase, please contact NEC TOKIN for updated product data.
- Please request for a specification sheet for detailed product data prior to the purchase.
- Before using the product in this catalog, please read "Precautions" and other safety precautions listed in the printed version catalog.

Precautions for use

- This series is exclusively for reflow soldering. It is designed for thermal conduction system such as combination use of infrared ray and heat blow. Consult with NEC TOKIN before applying other methods.
- The reflow condition must be kept within reflow profile graphs shown below.
- Applying reflow soldering is limited to 2 times. After the first reflow, cool down the capacitor thoroughly to 5-35°C before the second reflow.

Always consult with NEC TOKIN when applying reflow soldering in a more severe condition than the condition described here.

• FCS Type

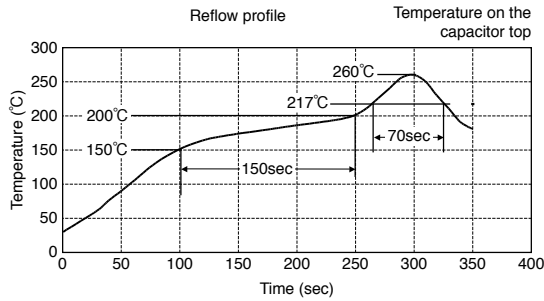

• Above "Reflow Profile" graph indicates temperature at the terminals and capacitor top.

Peak temperature	Below 260 °C
Over 255 °C	Within 10sec.
Over 230 °C	Within 45sec.
Over 220 °C	Within 60sec.
Over 217 °C	Within 70sec.
Time between 150 °C to 200 °C (temperature zone over 170 °C = within 50sec.)	150sec.

• FC Type

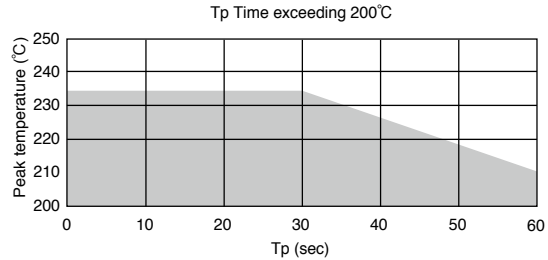
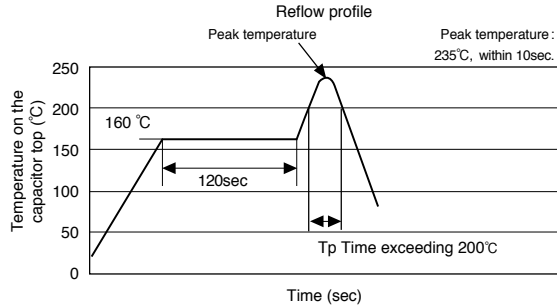

• Above "Reflow Profile" graph indicates temperature at the terminals and capacitor top.



- All specifications in this catalog and production status of products are subject to change without notice. Prior to the purchase, please contact NEC TOKIN for updated product data.
- Please request for a specification sheet for detailed product data prior to the purchase.
- Before using the product in this catalog, please read "Precautions" and other safety precautions listed in the printed version catalog.

Tape and Reel Dimensions

[Reel Dimensions]

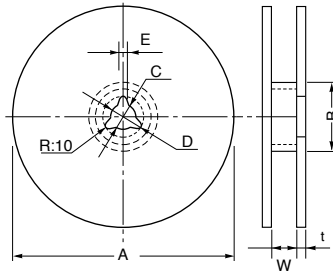

(mm)

Mark	TBR24	TBR32	TBR44
A	380±2	330±2	380±2
B	Product height 5.5mm	80±1	100±1
	Product height 8.5mm	100±1	100±1
C	13±0.5	13±0.5	13±0.5
D	21±0.8	21±0.8	21±0.8
E	2±0.5	2±0.5	2±0.5
W	Product height 5.5mm	25.5±0.5	33.5±1.0
	Product height 8.5mm	25.5±1.0	45.5±1.0
t	2.0	2.0	2.0

Dimensions of indented [square-hole plastic tape]

● TBR16/24

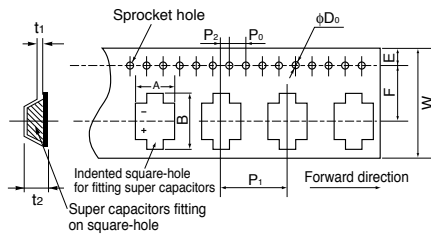

(mm)

Mark	TBR24	TBR32	TBR44
W	24.0	32.0	44.0
A	11.4	18.0	23.0
B	13.0	20.0	25.0
P ₀	4.0	4.0	4.0
P ₁	16.0	24.0	32.0
P ₂	2.0	2.0	2.0
F	11.5	14.2	20.2
φD ₀	1.55	1.55	1.55
t ₁	0.4	0.5	0.5
E	1.75	1.75	1.75
t ₂	Product height 5.5mm	6.0	10.0
	Product height 8.5mm	8.4	12.0
G	—	28.4	40.4

● TBR32/44

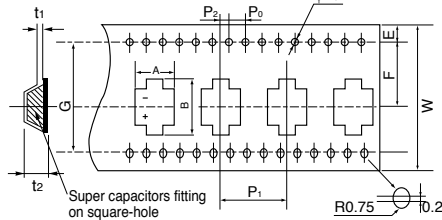

Recommended land pattern

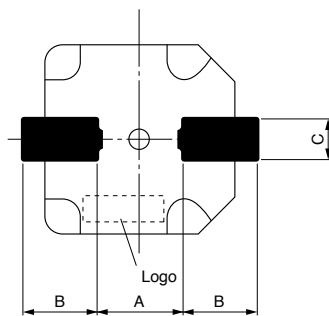

Land pattern

(mm)

Part Number	A	B	C
FC0H473ZFTBR24	5.0	4.6	2.5
FC0H104ZFTBR24	5.0	4.6	2.5
FC0H224ZFTBR24	5.0	4.6	2.5
FC0H474ZFTBR32-SS	5.0	10.0	2.5
FC0H105ZFTBR44-SS	10.0	10.5	3.5
FC0V104ZFTBR24	5.0	4.6	2.5
FC0V224ZFTBR24	5.0	4.6	2.5
FC0V474ZFTBR24	5.0	4.6	2.5

FCS0H473ZFTBR24	5.0	4.9	2.5
FCS0H104ZFTBR24	5.0	4.9	2.5
FCS0H224ZFTBR24	5.0	4.9	2.5
FCS0V104ZFTBR24	5.0	4.9	2.5
FCS0V224ZFTBR24	5.0	4.9	2.5
FCS0V474ZFTBR24	5.0	4.9	2.5

Lead terminal

(mm)

Part Number	A	B	C
FC0H473ZFTBR24	5.0	3.6	1.2
FC0H104ZFTBR24	5.0	3.6	1.2
FC0H224ZFTBR24	5.0	3.6	1.2
FC0H474ZFTBR32-SS	5.0	6.8	1.2
FC0H105ZFTBR44-SS	10.0	7.0	1.4
FC0V104ZFTBR24	5.0	3.6	1.2
FC0V224ZFTBR24	5.0	3.6	1.2
FC0V474ZFTBR24	5.0	3.6	1.2

FCS0H473ZFTBR24	5.0	3.9	1.2
FCS0H104ZFTBR24	5.0	3.9	1.2
FCS0H224ZFTBR24	5.0	3.9	1.2
FCS0V104ZFTBR24	5.0	3.9	1.2
FCS0V224ZFTBR24	5.0	3.9	1.2
FCS0V474ZFTBR24	5.0	3.9	1.2



- All specifications in this catalog and production status of products are subject to change without notice. Prior to the purchase, please contact NEC TOKIN for updated product data.
- Please request for a specification sheet for detailed product data prior to the purchase.
- Before using the product in this catalog, please read "Precautions" and other safety precautions listed in the printed version catalog.

Specifications

Item	Series name		FC		Test conditions (conforming to JIS C 5160-1)
			5.5V type, 3.5V type		
Category temperature range			-25°C to +70°C		
MAX operating voltage			5.5Vdc, 3.5Vdc		
Capacitance			Refer to standard ratings		Refer to "Measurement Conditions"
Capacitance allowance			+80%, -20%		Refer to "Measurement Conditions"
ESR			Refer to standard ratings		Measured at 1kHz, 10mA; See also "Measurement Conditions"
Current (30-minutes value)			Refer to standard ratings		Refer to "Measurement Conditions"
* Surge	Capacitance		More than 90% of initial ratings		Surge voltage : 4.0V (3.5V type, 3.6V type) : 6.3V (5.5V type) Charge : 30 sec. Discharge : 9min 30sec. Number of cycles : 1000 Series resistance : 0.047F 300Ω : 0.10F 150Ω : 0.22F 56Ω : 0.47F 30Ω : 1.0F 15Ω Discharge resistance : 0Ω Temperature : 70±2°C
	ESR		Not to exceed 120% of initial ratings		
	Current (30 minutes value)		Not to exceed 120% of initial ratings		
	Appearance		No obvious abnormality		
* Characteristics in different temperature	Capacitance	Phase 2	50% higher than initial value		Conforms to 4.17 Phase1 : +25±2°C Phase2 : -25±2°C Phase4 : +25±2°C Phase5 : +70±2°C Phase6 : +25±2°C
	ESR		400% or less than initial value		
	Capacitance	Phase 3			
	ESR				
	Capacitance	Phase 5	200% or less than initial value		
	ESR		Satisfy initial ratings		
	Current (30 minutes value)	Phase 6	1.5CV (mA) or below		
	Capacitance		Within ±20% of initial value		
	ESR		Satisfy initial ratings		
Current (30 minutes value)			Satisfy initial ratings		
* Vibration resistance	Capacitance	Satisfy initial ratings		Conforms to 4.13 Frequency : 10 to 55 Hz Testing time : 6 hours	
	ESR				
	Current (30 minutes value)				
	Appearance	No obvious abnormality			
* Solder heat resistance	Capacitance	Satisfy initial ratings		Cooled down to ambient temperature after reflow soldering, then the product must fulfill the condition stated left. (See page 10 for reflow condition)	
	ESR				
	Current (30 minutes value)				
	Appearance	No obvious abnormality			
* Temperature cycle	Capacitance	Satisfy initial ratings		Conforms to 4.12 Temperature condition : -25°C → Room temperature → +70°C → Room temperature Number of cycles : 5 Cycles	
	ESR				
	Current (30 minutes value)				
	Appearance	No obvious abnormality			
* High temp. and high humidity resistance	Capacitance	Within ±20% of initial value		Conforms to 4.14 Temperature : 40±2°C Relative humidity : 90 to 95 %RH Testing time : 240±8 hours	
	ESR	Not to exceed 120% of initial ratings			
	Current (30 minutes value)	Not to exceed 120% of initial ratings			
	Appearance	No obvious abnormality			
* High temperature load	Capacitance	Within ±30% of initial value		Conforms to 4.15 Voltage applied : MAX operating voltage Series protection resistance : 0Ω Testing time : 1000±#Hours	
	ESR	Below 200% of initial ratings			
	Current (30 minutes value)	Below 200% of initial ratings			
	Appearance	No obvious abnormality			
* Self discharge characteristics (voltage holding characteristics)			5.5V type: Voltage between terminal leads higher than 4.2V 3.5V type: Not specified		Charging condition Voltage applied : 5.0Vdc (Terminal at the case's side be negative) Series resistance : 0Ω Charging time : 24 hours
					Storage Let stand for 24 hours in condition described below with terminals opened. Ambient temperature : Lower than 25°C Relative humidity : Lower than 70%RH

As for items with "*", it must fulfill the above condition after the reflow soldering. (See page 10 for reflow conditions)

12 Super Capacitors Vol.13



- All specifications in this catalog and production status of products are subject to change without notice. Prior to the purchase, please contact NEC TOKIN for updated product data.
- Please request for a specification sheet for detailed product data prior to the purchase.
- Before using the product in this catalog, please read "Precautions" and other safety precautions listed in the printed version catalog.

6.2 FM Series

Dimensions

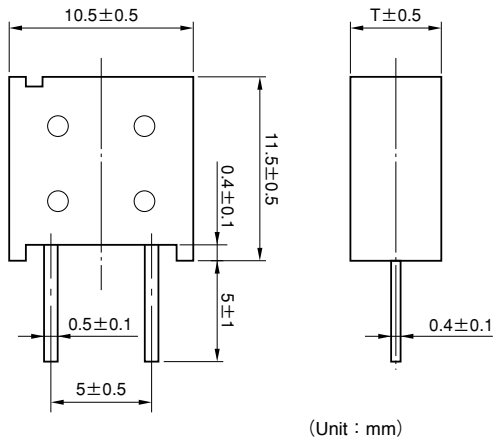

Markings

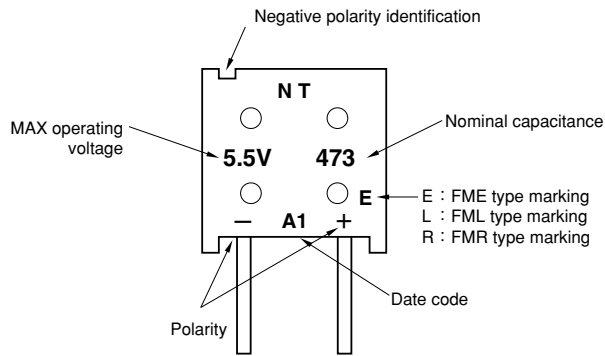

Lead terminal forming example

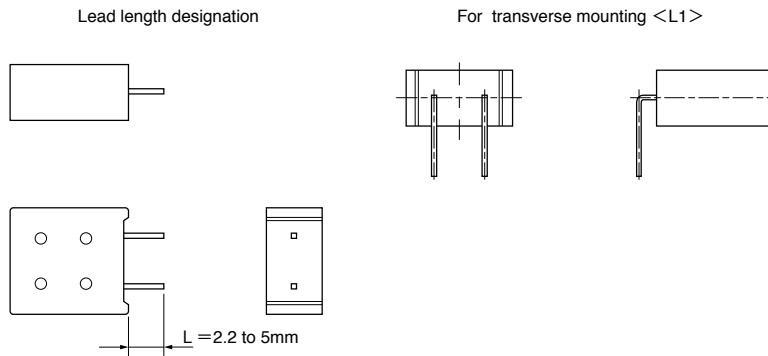

- All specifications in this catalog and production status of products are subject to change without notice. Prior to the purchase, please contact NEC TOKIN for updated product data.
- Please request for a specification sheet for detailed product data prior to the purchase.
- Before using the product in this catalog, please read "Precautions" and other safety precautions listed in the printed version catalog.

Specifications

● **5.5V Type**

Part Number		MAX operating voltage (Vdc)	Nominal capacitance		MAX ESR (at 1 kHz) (Ω)	MAX current at 30 min. (mA)	Voltage holding characteristics (V)	T (mm)	Weight (g)
Bulk	Ammo pack		Charge system(F)	Discharge system(F)					
FM0H103ZF	FM0H103ZFTP ()	5.5	0.01	0.014	300	0.015	4.2	5.0	1.3
FM0H223ZF	FM0H223ZFTP ()	5.5	0.022	0.028	200	0.033	4.2	5.0	1.3
FM0H473ZF	FM0H473ZFTP ()	5.5	0.047	0.06	200	0.071	4.2	5.0	1.3
FM0H104ZF	FM0H104ZFTP ()	5.5	0.10	0.13	100	0.15	4.2	6.5	1.6
FM0H224ZF	FM0H224ZFTP ()	5.5	—	0.22	100	0.33	4.2	6.5	1.6

To complete the part number, insert lead length (16mm or 18mm) in to the "()"

● **3.5V Type**

Part Number		MAX operating voltage (Vdc)	Nominal capacitance		MAX ESR (at 1 kHz) (Ω)	MAX current at 30 min. (mA)	T (mm)	Weight (g)
Bulk	Ammo pack		Charge system(F)	Discharge system(F)				
FM0V473ZF	FM0V473ZFTP ()	3.5	0.047	0.06	200	0.042	5.0	1.3
FM0V104ZF	FM0V104ZFTP ()	3.5	0.10	0.13	100	0.090	5.0	1.3
FM0V224ZF	FM0V224ZFTP ()	3.5	0.22	0.30	100	0.20	6.5	1.6

To complete the part number, insert lead length (16mm or 18mm) in to the "()"

● **6.5V Type**

Part Number		MAX operating voltage (Vdc)	Nominal capacitance		MAX ESR (at 1 kHz) (Ω)	MAX current at 30 min. (mA)	T (mm)	Weight (g)
Bulk	Ammo pack		Charge system(F)	Discharge system(F)				
FM0J473ZF	FM0J473ZFTP ()	6.5	0.047	0.062	200	0.071	6.5	1.6

To complete the part number, insert lead length (16mm or 18mm) in to the "()"

● **FME, FML Type (Backup Large Current, mA Order)**

Part Number		MAX operating voltage (Vdc)	Nominal capacitance		MAX ESR (at 1 kHz) (Ω)	MAX current at 30 min. (mA)	T (mm)	Weight (g)
Bulk	Ammo pack		Charge system(F)	Discharge system(F)				
FME0H223ZF	FME0H223ZFTP ()	5.5	0.022	0.028	40	0.033	5.0	1.3
FME0H473ZF	FME0H473ZFTP ()	5.5	0.047	0.06	20	0.071	5.0	1.3
FML0H333ZF	FML0H333ZFTP ()	5.5	—	0.033	6.5	0.050	5.0	1.3

To complete the part number, insert lead length (16mm or 18mm) in to the "()"

● **FMR Type (MAX Operating Temperature 85°C Type)**

Part Number		MAX operating voltage (Vdc)	Nominal capacitance		MAX ESR (at 1 kHz) (Ω)	MAX current at 30 min. (mA)	Voltage holding characteristics (V)	T (mm)	Weight (g)
Bulk	Ammo pack		Charge system(F)	Discharge system(F)					
FMR0H473ZF	FMR0H473ZFTP ()	5.5	0.047	0.062	200	0.071	4.2	6.5	1.6
FMR0H104ZF	FMR0H104ZFTP ()	5.5	0.10	—	50	0.15	4.2	6.5	1.6
FMR0V104ZF	FMR0V104ZFTP ()	3.5	0.10	—	50	0.090	—	6.5	1.6

To complete the part number, insert lead length (16mm or 18mm) in to the "()"

14 Super Capacitors Vol.13



- All specifications in this catalog and production status of products are subject to change without notice. Prior to the purchase, please contact NEC TOKIN for updated product data.
- Please request for a specification sheet for detailed product data prior to the purchase.
- Before using the product in this catalog, please read "Precautions" and other safety precautions listed in the printed version catalog.

● FMC Type

Chip parts applicable to treatment in bond hardening furnace ($160 \pm 5^\circ\text{C}$ for 120 ± 10 seconds)

Dimensions

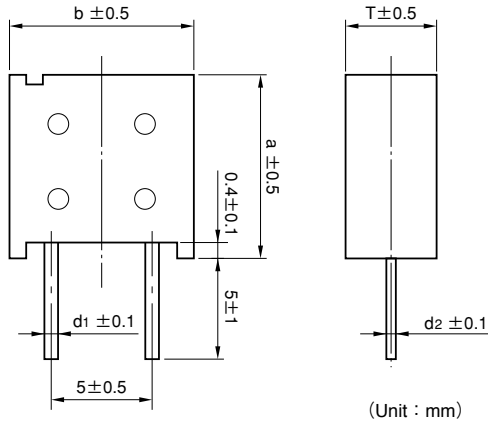

Markings

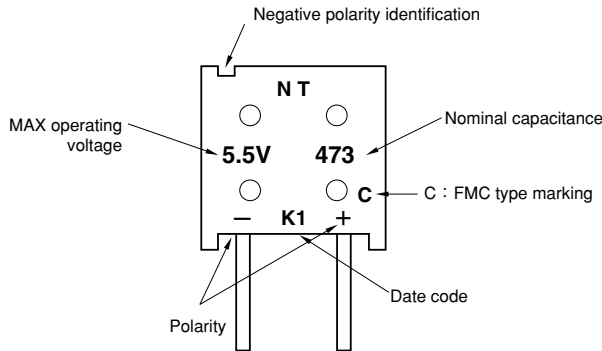

Specifications

Part Number		MAX operating voltage (Vdc)	Nominal capacitance		MAX ESR (at 1 kHz) (Ω)	MAX current at 30 min. (mA)	Voltage holding characteristics (V)	a (mm)	b (mm)	T (mm)	d ₁ (mm)	d ₂ (mm)	Weight (g)
Bulk	Ammo pack		Charge system(F)	Discharge system(F)									
FMC0H473ZF	FMC0H473ZFTP ()	5.5	0.047	0.06	100	0.071	4.2	11.5	10.5	5.0	0.5	0.4	1.3
FMC0H104ZF	FMC0H104ZFTP ()	5.5	0.10	0.13	50	0.15	4.2	11.5	10.5	6.5	0.5	0.4	1.6
FMC0H334ZF	FMC0H334ZFTP ()	5.5	-	0.33	25	0.50	4.2	15.0	14.0	9.0	0.6	0.6	3.5

To complete the part number, insert lead length (16mm or 18mm) in to the "()"



- All specifications in this catalog and production status of products are subject to change without notice. Prior to the purchase, please contact NEC TOKIN for updated product data.
- Please request for a specification sheet for detailed product data prior to the purchase.
- Before using the product in this catalog, please read "Precautions" and other safety precautions listed in the printed version catalog.

Taping Specification [except FMC0H334ZFTP()]

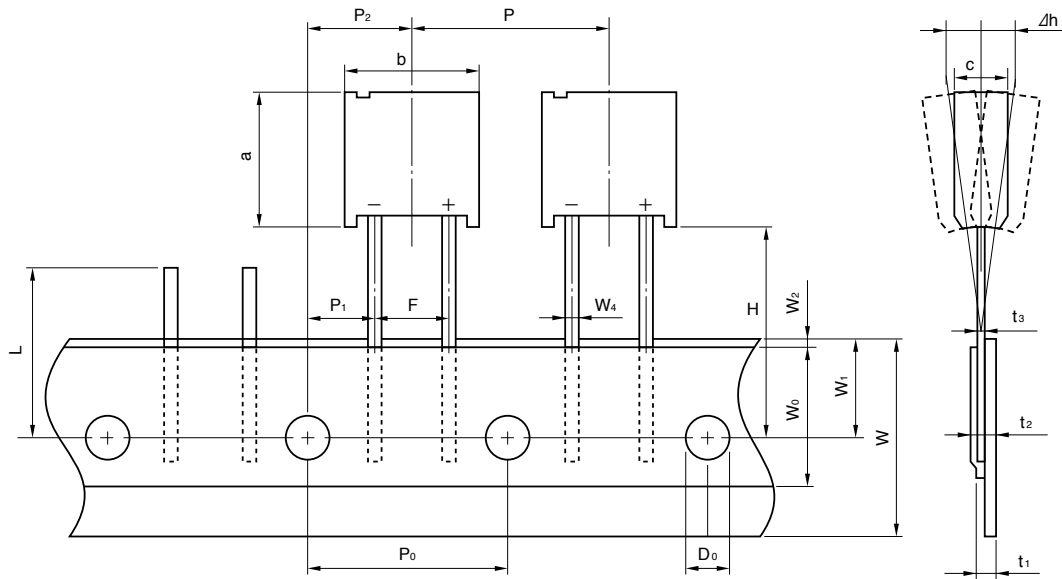

(Unit : mm)

Item	Symbol	Value	Tolerance	Remarks
Component Height	a	11.5	±0.5	
Component Width	b	10.5	±0.5	
Component Thickness	c	—	±0.5	5.5 V type : 5.0/0.010F to 0.047F, 6.5/0.047F 3.5 V type : 5.0/0.047F to 0.10F, 6.5/0.22F FME type : 5.0/0.022F to 0.047F FML type : 5.0/0.033F 6.5 V type : 6.5/0.047F, 0.10F FMR type : 6.5/0.047F FMC type : 5.0/0.047F, 6.5/0.10F
Lead-wire Width	W ₄	0.5	±0.1	
Lead-wire Thickness	t ₃	0.4	±0.1	
Pitch between Component	P	12.7	±1.0	
Sprocket Hole Pitch	P ₀	12.7	±0.3	
Sprocket Hole to Lead	P ₁	3.85	±0.7	
∕	P ₂	6.35	±1.3	
Lead Spacing	F	5.0	±0.5	
Component Alignment	Δh	2.0 Max.	—	Including tilting caused by bending lead wire.
Tape Width	W	18.0	+1.0 -0.5	
Hold-down tape Width	W ₀	12.5 Min.	—	
Sprocket Hole Position	W ₁	9.0	±0.5	
Hold-down Tape Position	W ₂	3.0 Max.	—	No protrusion of tape.
Component's Bottom Line Position	H	16.0	±0.5	
∕		18.0	±0.5	
Sprocket Hole Diameter	D ₀	φ 4.0	±0.2	
Total tape Thickness	t ₁	0.7	±0.2	
∕	t ₂	1.5 Max.	—	
Defect Component Cut-off Position	L	11.0 Max.	—	

16 Super Capacitors Vol.13



- All specifications in this catalog and production status of products are subject to change without notice. Prior to the purchase, please contact NEC TOKIN for updated product data.
- Please request for a specification sheet for detailed product data prior to the purchase.
- Before using the product in this catalog, please read "Precautions" and other safety precautions listed in the printed version catalog.

Taping Specification [FMC0H334ZFTP ()]

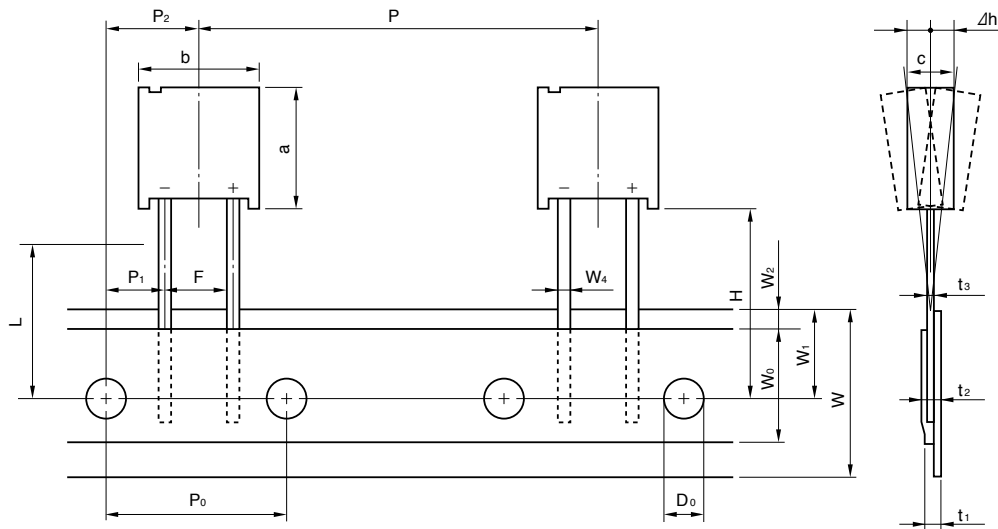

(Unit : mm)

Item	Symbol	Value	Tolerance	Remarks
Component Height	a	15.0	±0.5	
Component Width	b	14.0	±0.5	
Component Thickness	c	9.0	±0.5	
Lead-wire Width	W ₄	0.6	±0.1	
Lead-wire Thickness	t ₃	0.6	±0.1	
Pitch between Component	P	25.4	±1.0	
Sprocket Hole Pitch	P ₀	12.7	±0.3	
Sprocket Hole to Lead	P ₁	3.85	±0.7	
∕	P ₂	6.35	±1.3	
Lead Spacing	F	5.0	±0.5	
Component Alignment	Δh	2.0 Max.	—	Including tilting caused by bending lead wire
Tape Width	W	18.0	+1.0 -0.5	
Hold-down tape Width	W ₀	12.5 Min.	—	
Sprocket Hole Position	W ₁	9.0	±0.5	
Hold-down Tape Position	W ₂	3.0 Max.	—	No protrusion of tape
Component's Bottom Line Position	H	16.0	±0.5	
∕		18.0	±0.5	
Sprocket Hole Diameter	D ₀	φ4.0	±0.2	
Total tape Thickness	t ₁	0.67	±0.2	
∕	t ₂	1.7 Max.	—	
Defect Component Cut-off Position	L	11.0 Max.	—	



- All specifications in this catalog and production status of products are subject to change without notice. Prior to the purchase, please contact NEC TOKIN for updated product data.
- Please request for a specification sheet for detailed product data prior to the purchase.
- Before using the product in this catalog, please read "Precautions" and other safety precautions listed in the printed version catalog.

Specifications

Item	Series name	5.5V type, 3.5V type, 6.5V type FMC type	FML, FME type	Test conditions (conforming to JIS C 5160-1)
Category temperature range		-25 °C to +70 °C	-25 °C to +70 °C	
MAX operating voltage		5.5Vdc, 3.5Vdc, 6.5Vdc	5.5Vdc	
Capacitance		5.5V : 0.010F to 0.33F 3.5V : 0.047F to 0.22F 6.5V : 0.047	0.022F, 0.033F, 0.047F	Refer to "Measurement Conditions"
Capacitance allowance		+80 %, -20 %	+80 %, -20 %	Refer to "Measurement Conditions"
ESR		Refer to standard ratings	Refer to standard ratings	Measured at 1kHz, 10mA ; See also "Measurement Conditions"
Current (30-minutes value)		Refer to standard ratings	Refer to standard ratings	Refer to "Measurement Conditions"
Surge	Capacitance	More than 90% of initial ratings	More than 90% of initial ratings	Surge voltage : 4.0V (3.5V type) : 6.3V (5.5V type) : 7.4V (6.5V type) Charge : 30 sec. Discharge : 9min 30sec. Number of cycles : 1000 Series resistance : 0.010F 1500 Ω : 0.022F 560 Ω : 0.033F 510 Ω : 0.047F 300 Ω : 0.068F 240 Ω : 0.10F 150 Ω : 0.22F 56 Ω : 0.33F 51 Ω Discharge resistance : 0 Ω Temperature : 70±2 °C
	ESR	Not to exceed 120% of initial ratings	Not to exceed 120% of initial ratings	
	Current (30 minutes value)	Not to exceed 120% of initial ratings	Not to exceed 120% of initial ratings	
	Appearance	No obvious abnormality	No obvious abnormality	
Characteristics in different temperature	Capacitance	Phase 2 50% or higher than initial value	Phase 2 50% or higher than initial value	Conforms to 4.17 Phase1 : +25±2 °C Phase2 : -25±2 °C Phase4 : +25±2 °C Phase5 : +70±2 °C Phase6 : +25±2 °C
	ESR	400% or less than initial value	400% or less than initial value	
	Capacitance	Phase 3	Phase 3	
	ESR			
	Capacitance	Phase 5 200% or less than initial value	Phase 5 200% or less than initial value	
	ESR	Satisfy initial ratings	Satisfy initial ratings	
	Current (30 minutes value)	1.5CV (mA) or below	1.5CV (mA) or below	
	Capacitance	Phase 6 Within ±20% of initial value	Phase 6 Within ±20% of initial value	
ESR	Satisfy initial ratings	Satisfy initial ratings		
Current (30 minutes value)	Satisfy initial ratings	Satisfy initial ratings		
Lead strength (tensile)		No terminal damage	No terminal damage	Conforms to 4.9
Vibration resistance	Capacitance	Satisfy initial ratings	Satisfy initial ratings	Conforms to 4.13 Frequency : 10 to 55 Hz Testing time : 6 hours
	ESR			
	Current (30 minutes value)			
	Appearance			
Solderability		Over 3/4 of the terminal should be covered by the new solder	Over 3/4 of the terminal should be covered by the new solder	Conforms to 4.11 Solder temp : 245±5 °C Dipping time : 5±0.5 sec. 1.6mm from the bottom should be dipped.
Solder heat resistance	Capacitance	Satisfy initial ratings	Satisfy initial ratings	Conforms to 4.10 Solder temp : 260±10 °C Dipping time : 10±1 sec. 1.6mm from the bottom should be dipped.
	ESR			
	Current (30 minutes value)			
	Appearance			
Temperature cycle	Capacitance	Satisfy initial ratings	Satisfy initial ratings	Conforms to 4.12 Temperature condition : -25 °C → Room temperature → +70 °C → Room temperature Number of cycles : 5 Cycles
	ESR			
	Current (30 minutes value)			
	Appearance			
High temp. and high humidity resistance	Capacitance	Within ±20% of initial value	Within ±20% of initial value	Conforms to 4.14 Temperature : 40±2 °C Relative humidity : 90 to 95 %RH Testing time : 240±8 hours
	ESR	Not to exceed 120% of initial ratings	Not to exceed 120% of initial ratings	
	Current (30 minutes value)	Not to exceed 120% of initial ratings	Not to exceed 120% of initial ratings	
	Appearance	No obvious abnormality	No obvious abnormality	
High temperature load	Capacitance	Within ±30% of initial value	Within ±30% of initial value	Conforms to 4.15 Temperature : 70±2 °C Voltage applied : MAX operating voltage Series protection resistance : 0 Ω Testing time : 1000* Hours
	ESR	Below 200% of initial ratings	Below 200% of initial ratings	
	Current (30 minutes value)	Below 200% of initial ratings	Below 200% of initial ratings	
	Appearance	No obvious abnormality	No obvious abnormality	
Self discharge characteristics (voltage holding characteristics)		5.5V type: Voltage between terminal leads higher than 4.2V 3.5V type: Not specified 6.5V type: Not specified		Charging condition Voltage applied : 5.0Vdc (Terminal at the case's side be negative) Series resistance : 0 Ω Charging time : 24 hours Storage Let stand for 24 hours in condition described below with terminals opened. Ambient temperature : Lower than 25 °C Relative humidity : Lower than 70%RH

18 Super Capacitors Vol.13



- All specifications in this catalog and production status of products are subject to change without notice. Prior to the purchase, please contact NEC TOKIN for updated product data.
- Please request for a specification sheet for detailed product data prior to the purchase.
- Before using the product in this catalog, please read "Precautions" and other safety precautions listed in the printed version catalog.

Specifications

Item	Series name	FMR type	Test conditions (conforming to JIS C 5160-1)	
Category temperature range		-40 °C to +85 °C		
MAX operating voltage		5.5Vdc, 3.5Vdc		
Capacitance		0.047F, 0.10F	Refer to "Measurement Conditions"	
Capacitance allowance		+80 %, -20 %	Refer to "Measurement Conditions"	
ESR		Refer to standard ratings	Measured at 1kHz, 10mA ; See also "Measurement Conditions"	
Current (30-minutes value)		Refer to standard ratings	Refer to "Measurement Conditions"	
Surge	Capacitance	More than 90% of initial ratings	Surge voltage : 4.0V (3.5V type) : 6.3V (5.5V type) Charge : 30 sec. Discharge : 9min 30sec. Number of cycles : 1000 Series resistance : 0.047F 300Ω : 0.10F 150Ω Discharge resistance : 0Ω Temperature : 85±2 °C	
	ESR	Not to exceed 120% of initial ratings		
	Current (30 minutes value)	Not to exceed 120% of initial ratings		
	Appearance	No obvious abnormality		
Characteristics in different temperature	Capacitance	Phase 2	50% or higher than initial value	Conforms to 4.17 Phase1 : +25±2 °C Phase2 : -25±2 °C Phase3 : -40±2 °C Phase4 : +25±2 °C Phase5 : +70±2 °C Phase6 : +25±2 °C
	ESR		400% or less than initial value	
	Capacitance	Phase 3	30% or higher than initial value	
	ESR		Below 700% of the initial value	
	Capacitance	Phase 5	200% or less than initial value	
	ESR		Satisfy initial ratings	
	Current (30 minutes value)	Phase 6	1.5CV (mA) or below	
	Capacitance		Within ±20% of initial value	
ESR	Satisfy initial ratings			
Current (30 minutes value)	Satisfy initial ratings			
Lead strength (tensile)		No terminal damage	Conforms to 4.9	
Vibration resistance	Capacitance	Satisfy initial ratings	Conforms to 4.13 Frequency : 10 to 55 Hz Testing time : 6 hours	
	ESR			
	Current (30 minutes value)			
	Appearance			No obvious abnormality
Solderability		Over 3/4 of the terminal should be covered by the new solder	Conforms to 4.11 Solder temp : 245±5 °C Dipping time : 5±0.5 sec. 1.6mm from the bottom should be dipped.	
Solder heat resistance	Capacitance	Satisfy initial ratings	Conforms to 4.10 Solder temp : 260±10 °C Dipping time : 10±1 sec. 1.6mm from the bottom should be dipped.	
	ESR			
	Current (30 minutes value)			
	Appearance			No obvious abnormality
Temperature cycle	Capacitance	Satisfy initial ratings	Conforms to 4.12 Temperature condition : -40 °C →Room temperature→ +85 °C →Room temperature Number of cycles : 5 Cycles	
	ESR			
	Current (30 minutes value)			
	Appearance			No obvious abnormality
High temp. and high humidity resistance	Capacitance	Within ±20% of initial value	Conforms to 4.14 Temperature : 40±2 °C Relative humidity : 90 to 95 %RH Testing time : 240±8 hours	
	ESR	Not to exceed 120% of initial ratings		
	Current (30 minutes value)	Not to exceed 120% of initial ratings		
	Appearance	No obvious abnormality		
High temperature load	Capacitance	Within ±30% of initial value	Conforms to 4.15 Temperature : 85±2 °C Voltage applied : MAX operating voltage Series protection resistance : 0Ω Testing time : 1000*#Hours	
	ESR	Below 200% of initial ratings		
	Current (30 minutes value)	Below 200% of initial ratings		
	Appearance	No obvious abnormality		
Self discharge characteristics (voltage holding characteristics)		5.5V type: Voltage between terminal leads higher than 4.2V 3.5V type: Not specified	Charging condition Voltage applied : 5.0Vdc (Terminal at the case's side be negative) Series resistance : 0Ω Charging time : 24 hours	
			Storage Let stand for 24 hours in condition described below with terminals opened. Ambient temperature : Lower than 25 °C Relative humidity : Lower than 70%RH	



- All specifications in this catalog and production status of products are subject to change without notice. Prior to the purchase, please contact NEC TOKIN for updated product data.
- Please request for a specification sheet for detailed product data prior to the purchase.
- Before using the product in this catalog, please read "Precautions" and other safety precautions listed in the printed version catalog.

6.3 FG Series

Dimensions

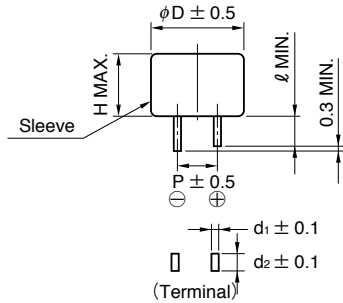

Markings on sleeve

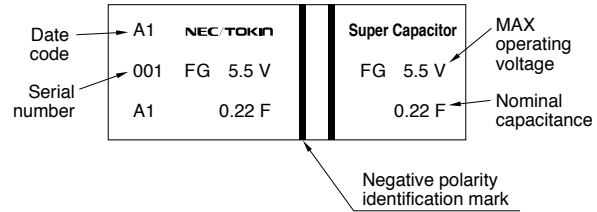

● FG Type

Specifications

Part Number	MAX operating voltage (Vdc)	Nominal capacitance		MAX ESR (at 1 kHz) (Ω)	MAX current at 30 min. (mA)	Voltage holding characteristics (V)	Dimension (unit:mm)						Weight (g)
		Charge system (F)	Discharge system (F)				ϕD	H	P	l	d_1	d_2	
FG0H103ZF	5.5	0.010	0.013	300	0.015	4.2	11.0	5.5	5.08	2.7	0.2	1.2	0.9
FG0H223ZF	5.5	0.022	0.028	200	0.033	4.2	11.0	5.5	5.08	2.7	0.2	1.2	1.0
FG0H473ZF	5.5	0.047	0.060	200	0.071	4.2	11.0	5.5	5.08	2.7	0.2	1.2	1.0
FG0H104ZF	5.5	0.10	0.13	100	0.15	4.2	11.0	6.5	5.08	2.7	0.2	1.2	1.3
FG0H224ZF	5.5	0.22	0.28	100	0.33	4.2	13.0	9.0	5.08	2.2	0.4	1.2	2.5
FG0H474ZF	5.5	0.47	0.60	120	0.71	4.2	14.5	18.0	5.08	2.4	0.4	1.2	5.1
FG0H105ZF	5.5	1.0	1.3	65	1.5	4.2	16.5	19.0	5.08	2.7	0.4	1.2	7.0
FG0H225ZF	5.5	2.2	2.8	35	3.3	4.2	21.5	19.0	7.62	3.0	0.6	1.2	12.1
FG0H475ZF	5.5	4.7	6.0	35	7.1	4.2	28.5	22.0	10.16	6.1	0.6	1.4	27.3
FG0V155ZF	3.5	1.5	2.2	65	1.5	—	16.5	14.0	5.08	3.1	0.4	1.2	5.2

● FGH Type

Specifications

Part Number	MAX operating voltage (Vdc)	Nominal capacitance		MAX ESR (at 1 kHz) (Ω)	MAX current at 30 min. (mA)	Voltage holding characteristics (V)	Dimension (unit:mm)						Weight (g)
		Charge system (F)	Discharge system (F)				ϕD	H	P	l	d_1	d_2	
FGH0H104ZF	5.5	—	0.10	100	0.15	4.2	11.0	5.5	5.08	2.7	0.2	1.2	1.0
FGH0H224ZF	5.5	—	0.22	100	0.33	4.2	11.0	7.0	5.08	2.7	0.2	1.2	1.3
FGH0H474ZF	5.5	—	0.47	65	0.71	4.2	16.5	8.0	5.08	2.7	0.4	1.2	4.1
FGH0H105ZF	5.5	—	1.0	35	1.5	4.2	21.5	9.5	7.62	3.0	0.6	1.2	7.2

● FGR Type

Specifications

Part Number	MAX operating voltage (Vdc)	Nominal capacitance		MAX ESR (at 1 kHz) (Ω)	MAX current at 30 min. (mA)	Voltage holding characteristics (V)	Dimension (unit:mm)						Weight (g)
		Charge system (F)	Discharge system (F)				ϕD	H	P	l	d_1	d_2	
FGR0H474ZF	5.5	0.47	0.60	120	0.71	4.2	14.5	18.0	5.08	2.4	0.4	1.2	5.1
FGR0H105ZF	5.5	1.0	1.3	65	1.5	4.2	16.5	19.0	5.08	2.7	0.4	1.2	7.0
FGR0H225ZF	5.5	2.2	2.8	35	3.3	4.2	21.5	19.0	7.62	3.0	0.6	1.2	12.1



- All specifications in this catalog and production status of products are subject to change without notice. Prior to the purchase, please contact NEC TOKIN for updated product data.
- Please request for a specification sheet for detailed product data prior to the purchase.
- Before using the product in this catalog, please read "Precautions" and other safety precautions listed in the printed version catalog.

Specifications

Item	Series name	FG, FGH type	FGR type	Test conditions (conforming to JIS C 5160-1)		
Category temperature range		-25°C to +70°C	-40°C to +85°C			
MAX operating voltage		5.5Vdc, 3.5Vdc	5.5Vdc			
Capacitance		FG : 0.010F to 4.7F FGH : 0.10F to 1.0F	0.47F to 2.2F	Refer to "Measurement Conditions"		
Capacitance allowance		+80%, -20%	+80%, -20%	Refer to "Measurement Conditions"		
ESR		Refer to standard ratings	Refer to standard ratings	Measured at 1kHz, 10mA; See also "Measurement Conditions"		
Current (30-minutes value)		Refer to standard ratings	Refer to standard ratings	Refer to "Measurement Conditions"		
Surge	Capacitance	More than 90% of initial ratings	More than 90% of initial ratings	Surge voltage : 6.3V (5.5V type) : 4.0V (3.5V type) Charge : 30 sec. Discharge : 9min 30sec. Number of cycles : 1000 Series resistance : 0.010F 1500Ω : 0.022F 560Ω : 0.047F 300Ω : 0.10F 150Ω : 0.22F 56Ω : 0.47F 30Ω : 1.0F, 1.5F 15Ω : 2.2F, 4.7F 10Ω Discharge resistance : 0Ω Temperature : 85±2°C (FGR) : 70±2°C (FG, FGH)		
	ESR	Not to exceed 120% of initial ratings	Not to exceed 120% of initial ratings			
	Current (30 minutes value)	Not to exceed 120% of initial ratings	Not to exceed 120% of initial ratings			
	Appearance	No obvious abnormality	No obvious abnormality			
Characteristics in different temperature	Capacitance	Phase 2	50% or higher than initial value	Phase 2	50% or higher than initial value	Conforms to 4.17 Phase1 : +25±2°C Phase2 : -25±2°C Phase3 : -40±2°C (FGR) Phase4 : +25±2°C Phase5 : +70±2°C (FG, FGH) : +85±2°C (FGR) Phase6 : +25±2°C
	ESR	Phase 2	400% or less than initial value	Phase 2	400% or less than initial value	
	Capacitance	Phase 3	/	Phase 3	30% or higher than initial value	
	ESR	Phase 3		700% or less than initial value		
	Capacitance	Phase 5	200% or less than initial value	Phase 5	200% or less than initial value	
	ESR	Phase 5	Satisfy initial ratings	Phase 5	Satisfy initial ratings	
	Current (30 minutes value)	Phase 5	1.5CV (mA) or below	Phase 5	1.5CV (mA) or below	
	Capacitance	Phase 6	Within ±20% of initial value	Phase 6	Within ±20% of initial value	
ESR	Phase 6	Satisfy initial ratings	Phase 6	Satisfy initial ratings		
Current (30 minutes value)	Phase 6	Satisfy initial ratings	Phase 6	Satisfy initial ratings		
Lead strength (tensile)		No terminal damage	No terminal damage	Conforms to 4.9		
Vibration resistance	Capacitance	Satisfy initial ratings	Satisfy initial ratings	Conforms to 4.13 Frequency : 10 to 55 Hz Testing time : 6 hours		
	ESR					
	Current (30 minutes value)					
	Appearance					
Solderability		Over 3/4 of the terminal should be covered by the new solder	Over 3/4 of the terminal should be covered by the new solder	Conforms to 4.11 Solder temp : 245±5°C Dipping time : 5±0.5 sec. 1.6mm from the bottom should be dipped.		
Solder heat resistance	Capacitance	Satisfy initial ratings	Satisfy initial ratings	Conforms to 4.10 Solder temp : 260±10°C Dipping time : 10±1 sec. 1.6mm from the bottom should be dipped.		
	ESR					
	Current (30 minutes value)					
	Appearance					
Temperature cycle	Capacitance	Satisfy initial ratings	Satisfy initial ratings	Conforms to 4.12 Temperature condition : Category MIN temp→Room temp→ Category MAX temp→Room temp Number of cycles : 5 Cycles		
	ESR					
	Current (30 minutes value)					
	Appearance					
High temp. and high humidity resistance	Capacitance	Within ±20% of initial value	Within ±20% of initial value	Conforms to 4.14 Temperature : 40±2°C Relative humidity : 90 to 95 %RH Testing time : 240±8 hours		
	ESR	Not to exceed 120% of initial ratings	Not to exceed 120% of initial ratings			
	Current (30 minutes value)	Not to exceed 120% of initial ratings	Not to exceed 120% of initial ratings			
	Appearance	No obvious abnormality	No obvious abnormality			
High temperature load	Capacitance	Within ±30% of initial value	Within ±30% of initial value	Conforms to 4.15 Temp : Category MAX temp ±2°C Voltage applied : MAX operating voltage Series protection resistance : 0Ω Testing time : 1000 ^{hrs} Hours		
	ESR	Below 200% of initial ratings	Below 200% of initial ratings			
	Current (30 minutes value)	Below 200% of initial ratings	Below 200% of initial ratings			
	Appearance	No obvious abnormality	No obvious abnormality			
Self discharge characteristics (voltage holding characteristics)		5.5V type: Voltage between terminal leads higher than 4.2V 3.5V type: Not specified	Voltage between terminal leads higher than 4.2V	Charging condition Voltage applied : 5.0Vdc (Terminal at the case's side be negative) Series resistance : 0Ω Charging time : 24 hours		
				Storage Let stand for 24 hours in condition described below with terminals opened. Ambient temperature : Lower than 25°C Relative humidity : Lower than 70%RH		



- All specifications in this catalog and production status of products are subject to change without notice. Prior to the purchase, please contact NEC TOKIN for updated product data.
- Please request for a specification sheet for detailed product data prior to the purchase.
- Before using the product in this catalog, please read "Precautions" and other safety precautions listed in the printed version catalog.

6.4 FT Series

Dimensions

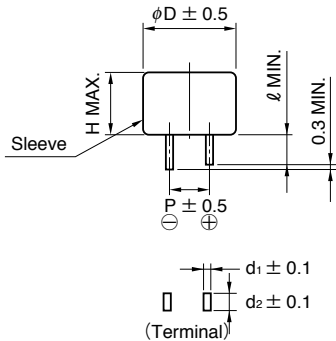

Markings on sleeve

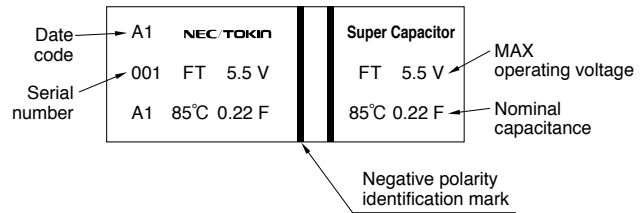

Specifications

Part Number	MAX operating voltage (Vdc)	Nominal capacitance		MAX ESR (at 1 kHz) (Ω)	MAX current at 30 min. (mA)	Dimension (unit:mm)						Weight (g)
		Charge system (F)	Discharge system (F)			ϕD	H	P	d_1	d_2	ℓ	
FT0H104ZF	5.5	0.10	0.14	16	0.15	11.5	8.5	5.08	0.4	1.2	2.7	1.6
FT0H224ZF	5.5	0.22	0.28	10	0.33	14.5	12.0	5.08	0.4	1.2	2.2	4.1
FT0H474ZF	5.5	0.47	0.60	6.5	0.71	16.5	13.0	5.08	0.4	1.2	2.7	5.3
FT0H105ZF	5.5	1.0	1.3	3.5	1.5	21.5	13.0	7.62	0.6	1.2	3.0	10.0
FT0H225ZF	5.5	2.2	2.8	1.8	3.3	28.5	14.0	10.16	0.6	1.4	6.1	18.0
FT0H335ZF	5.5	3.3	4.2	1.0	5.0	36.5	15.0	15.00	0.6	1.7	6.1	38.0
FT0H565ZF	5.5	5.6	7.2	0.6	8.4	44.5	17.0	20.00	1.0	1.4	6.1	72.0



- All specifications in this catalog and production status of products are subject to change without notice. Prior to the purchase, please contact NEC TOKIN for updated product data.
- Please request for a specification sheet for detailed product data prior to the purchase.
- Before using the product in this catalog, please read "Precautions" and other safety precautions listed in the printed version catalog.

Specifications

Item	Series name	FT type		Test conditions (conforming to JIS C 5160-1)
Category temperature range		-40 °C to +85 °C		
MAX operating voltage		5.5Vdc		
Capacitance		0.1F to 5.6F		Refer to "Measurement Conditions"
Capacitance allowance		+80 %, -20 %		Refer to "Measurement Conditions"
ESR		Refer to standard ratings		Measured at 1kHz, 10mA ; See also "Measurement Conditions"
Current (30-minutes value)		Refer to standard ratings		Refer to "Measurement Conditions"
Surge	Capacitance	More than 90% of initial ratings		Surge voltage : 6.3V Charge : 30 sec. Discharge : 9min 30sec. Number of cycles : 1000 Series resistance : 0.10F 150Ω : 0.22F 56Ω : 0.47F 30Ω : 1.0F 15Ω : 2.2F 10Ω : 3.3F 10Ω : 5.6F 10Ω Discharge resistance : 0Ω Temperature : 85±2°C
	ESR	Not to exceed 120% of initial ratings		
	Current (30 minutes value)	Not to exceed 120% of initial ratings		
	Appearance	No obvious abnormality		
Characteristics in different temperature	Capacitance	Phase 2	50% or higher than initial value	Conforms to 4.17 Phase1 : +25±2°C Phase2 : -25±2°C Phase3 : -40±2°C Phase4 : +25±2°C Phase5 : +70±2°C Phase6 : +25±2°C
	ESR		400% or less than initial value	
	Capacitance	Phase 3	30% or higher than initial value	
	ESR		700% or less than initial value	
	Capacitance	Phase 5	200% or less than initial value	
	ESR		Satisfy initial ratings	
	Current (30 minutes value)		1.5CV (mA) or below	
	Capacitance	Phase 6	Within ±20% of initial value	
	ESR		Satisfy initial ratings	
Current (30 minutes value)	Satisfy initial ratings			
Lead strength (tensile)		No terminal damage		Conforms to 4.9
Vibration resistance	Capacitance	Satisfy initial ratings		Conforms to 4.13 Frequency : 10 to 55 Hz Testing time : 6 hours
	ESR			
	Current (30 minutes value)			
	Appearance			
Solderability		Over 3/4 of the terminal should be covered by the new solder		Conforms to 4.11 Solder temp : 245±5°C Dipping time : 5±0.5 sec. 1.6mm from the bottom should be dipped.
Solder heat resistance	Capacitance	Satisfy initial ratings		Conforms to 4.10 Solder temp : 260±10°C Dipping time : 10±1 sec. 1.6mm from the bottom should be dipped.
	ESR			
	Current (30 minutes value)			
	Appearance			
Temperature cycle	Capacitance	Satisfy initial ratings		Conforms to 4.12 Temperature condition : -40°C →Room temperature→ +85°C →Room temperature Number of cycles : 5 Cycles
	ESR			
	Current (30 minutes value)			
	Appearance			
High temp. and high humidity resistance	Capacitance	Within ±20% of initial value		Conforms to 4.14 Temperature : 40±2°C Relative humidity : 90 to 95 %RH Testing time : 240±8 hours
	ESR	Not to exceed 120% of initial ratings		
	Current (30 minutes value)	Not to exceed 120% of initial ratings		
	Appearance	No obvious abnormality		
High temperature load	Capacitance	Within ±30% of initial value		Conforms to 4.15 Temperature : 85±2°C Voltage applied : MAX operating voltage Series protection resistance : 0Ω Testing time : 1000 ^{±10%} Hours
	ESR	Below 200% of initial ratings		
	Current (30 minutes value)	Below 200% of initial ratings		
	Appearance	No obvious abnormality		



- All specifications in this catalog and production status of products are subject to change without notice. Prior to the purchase, please contact NEC TOKIN for updated product data.
- Please request for a specification sheet for detailed product data prior to the purchase.
- Before using the product in this catalog, please read "Precautions" and other safety precautions listed in the printed version catalog.

6.5 FY Series

Dimensions

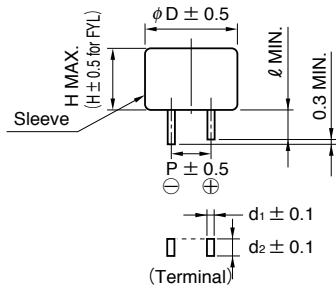

Markings on sleeve

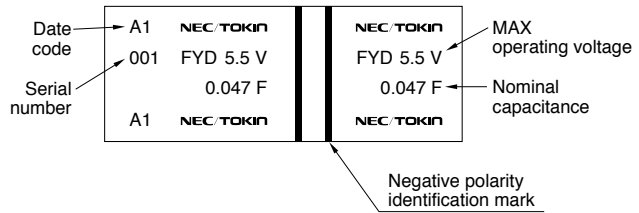

● FYD Type

Specifications

Part Number	MAX operating voltage (Vdc)	Nominal capacitance		MAX ESR (at 1 kHz) (Ω)	MAX current at 30 min. (mA)	Voltage holding characteristics (V)	Dimension (unit:mm)						Weight (g)
		Charge system (F)	Discharge system (F)				φD	H	P	ℓ	d ₁	d ₂	
FYD0H223ZF	5.5	0.022	0.033	220	0.033	4.2	11.5	8.5	5.08	2.7	0.4	1.2	1.6
FYD0H473ZF	5.5	0.047	0.070	220	0.071	4.2	11.5	8.5	5.08	2.7	0.4	1.2	1.7
FYD0H104ZF	5.5	0.10	0.14	100	0.15	4.2	13.0	8.5	5.08	2.2	0.4	1.2	2.4
FYD0H224ZF	5.5	0.22	0.35	120	0.33	4.2	14.5	15.0	5.08	2.4	0.4	1.2	4.3
FYD0H474ZF	5.5	0.47	0.75	65	0.71	4.2	16.5	15.0	5.08	2.7	0.4	1.2	6.0
FYD0H105ZF	5.5	1.0	1.6	35	1.5	4.2	21.5	16.0	7.62	3.0	0.6	1.2	11.0
FYD0H145ZF	5.5	1.4	2.1	45	2.1	4.2	21.5	19.0	7.62	3.0	0.6	1.2	12.0
FYD0H225ZF	5.5	2.2	3.3	35	3.3	4.2	28.5	22.0	10.16	6.1	0.6	1.4	22.9

● FYH Type

Specifications

Part Number	MAX operating voltage (Vdc)	Nominal capacitance		MAX ESR (at 1 kHz) (Ω)	MAX current at 30 min. (mA)	Voltage holding characteristics (V)	Dimension (unit:mm)						Weight (g)
		Charge system (F)	Discharge system (F)				φD	H	P	ℓ	d ₁	d ₂	
FYH0H223ZF	5.5	0.022	0.033	200	0.033	4.2	11.5	7.0	5.08	2.7	0.4	1.2	1.5
FYH0H473ZF	5.5	0.047	0.075	100	0.071	4.2	13.0	7.0	5.08	2.2	0.4	1.2	2.2
FYH0H104ZF	5.5	0.10	0.16	50	0.15	4.2	16.5	7.5	5.08	2.7	0.4	1.2	3.4
FYH0H224ZF	5.5	0.22	0.30	60	0.33	4.2	16.5	9.5	5.08	2.7	0.4	1.2	3.6
FYH0H474ZF	5.5	0.47	0.70	35	0.71	4.2	21.5	10.0	7.62	3.0	0.6	1.2	7.2
FYH0H105ZF	5.5	1.0	1.5	20	1.5	4.2	28.5	11.0	10.16	6.1	0.6	1.4	13.9

● FYL Type

Specifications

Part Number	MAX operating voltage (Vdc)	Nominal capacitance		MAX ESR (at 1 kHz) (Ω)	MAX current at 30 min. (mA)	Voltage holding characteristics (V)	Dimension (unit:mm)						Weight (g)
		Charge system (F)	Discharge system (F)				φD	H	P	ℓ	d ₁	d ₂	
FYL0H103ZF	5.5	0.01	0.013	300	0.015	4.2	11.0	5.0	5.08	2.7	0.2	1.2	0.9
FYL0H223ZF	5.5	0.022	0.028	200	0.033	4.2	11.0	5.0	5.08	2.7	0.2	1.2	1.0
FYL0H473ZF	5.5	0.047	0.061	200	0.071	4.2	12.0	5.0	5.08	2.7	0.2	1.2	1.2



- All specifications in this catalog and production status of products are subject to change without notice. Prior to the purchase, please contact NEC TOKIN for updated product data.
- Please request for a specification sheet for detailed product data prior to the purchase.
- Before using the product in this catalog, please read "Precautions" and other safety precautions listed in the printed version catalog.

Specifications

Item	Series name	FY type (FYD, FYH, FYL)		Test conditions (conforming to JIS C 5160-1)
Category temperature range		-25 °C to +70 °C		
MAX operating voltage		5.5Vdc		
Capacitance		Refer to standard ratings		Refer to "Measurement Conditions"
Capacitance allowance		+80 %, -20 %		Refer to "Measurement Conditions"
ESR		FYD : 0.022F to 2.2F FYH : 0.022F to 1.0F FYL : 0.010F to 0.047F		Measured at 1kHz, 10mA ; See also "Measurement Conditions"
Current (30-minutes value)		Refer to standard ratings		Refer to "Measurement Conditions"
Surge	Capacitance	More than 90% of initial ratings		Surge voltage : 6.3V Charge : 30 sec. Discharge : 9min 30sec. Number of cycles : 1000 Series resistance : 0.010F 1500 Ω : 0.022F 560 Ω : 0.047F 300 Ω : 0.068F 240 Ω : 0.10F 150 Ω : 0.22F 56 Ω : 0.47F 30 Ω : 1.0F, 1.4F 15 Ω : 2.2F 10 Ω Discharge resistance : 0 Ω Temperature : 70±2 °C
	ESR	Not to exceed 120% of initial ratings		
	Current (30 minutes value)	Not to exceed 120% of initial ratings		
	Appearance	No obvious abnormality		
Characteristics in different temperature	Capacitance	Phase 2	50% or higher than initial value	Conforms to 4.17 Phase1 : +25±2 °C Phase2 : -25±2 °C Phase4 : +25±2 °C Phase5 : +70±2 °C Phase6 : +25±2 °C
	ESR		400% or less than initial value	
	Capacitance	Phase 3		
	ESR			
	Capacitance	Phase 5	200% or less than initial value	
	ESR		Satisfy initial ratings	
	Current (30 minutes value)		1.5CV (mA) or below	
	Capacitance		Within ±20% of initial value	
Lead strength (tensile)	ESR	Phase 6	Satisfy initial ratings	
	Current (30 minutes value)		Satisfy initial ratings	
	ESR		Satisfy initial ratings	
Lead strength (tensile)		No terminal damage		Conforms to 4.9
Vibration resistance	Capacitance	Satisfy initial ratings		Conforms to 4.13 Frequency : 10 to 55 Hz Testing time : 6 hours
	ESR			
	Current (30 minutes value)			
	Appearance			
Solderability		Over 3/4 of the terminal should be covered by the new solder		Conforms to 4.11 Solder temp : 245±5 °C Dipping time : 5±0.5 sec. 1.6mm from the bottom should be dipped.
Solder heat resistance	Capacitance	Satisfy initial ratings		Conforms to 4.10 Solder temp : 260±10 °C Dipping time : 10±1 sec. 1.6mm from the bottom should be dipped.
	ESR			
	Current (30 minutes value)			
	Appearance			
Temperature cycle	Capacitance	Satisfy initial ratings		Conforms to 4.12 Temperature condition : -25 °C → Room temperature → +70 °C → Room temperature Number of cycles : 5 Cycles
	ESR			
	Current (30 minutes value)			
	Appearance			
High temp. and high humidity resistance	Capacitance	Within ±20% of initial value		Conforms to 4.14 Temperature : 40±2 °C Relative humidity : 90 to 95 %RH Testing time : 240±8 hours
	ESR	Not to exceed 120% of initial ratings		
	Current (30 minutes value)	Not to exceed 120% of initial ratings		
	Appearance	No obvious abnormality		
High temperature load	Capacitance	Within ±30% of initial value		Conforms to 4.15 Temperature : 70±2 °C Voltage applied : MAX operating voltage Series protection resistance : 0 Ω Testing time : 1000 ⁺ Hours
	ESR	Below 200% of initial ratings		
	Current (30 minutes value)	Below 200% of initial ratings		
	Appearance	No obvious abnormality		
Self discharge characteristics (voltage holding characteristics)	Voltage between terminal leads higher than 4.2V		Charging condition	Voltage applied : 5.0Vdc (Terminal at the case's side be negative) Series resistance : 0 Ω Charging time : 24 hours
			Storage	Let stand for 24 hours in condition described below with terminals opened. Ambient temperature : Lower than 25 °C Relative humidity : Lower than 70%RH



- All specifications in this catalog and production status of products are subject to change without notice. Prior to the purchase, please contact NEC TOKIN for updated product data.
- Please request for a specification sheet for detailed product data prior to the purchase.
- Before using the product in this catalog, please read "Precautions" and other safety precautions listed in the printed version catalog.

6.6 FR Series

Dimensions

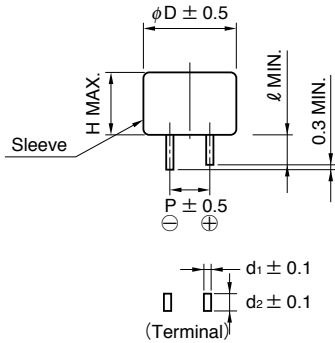

Markings on sleeve

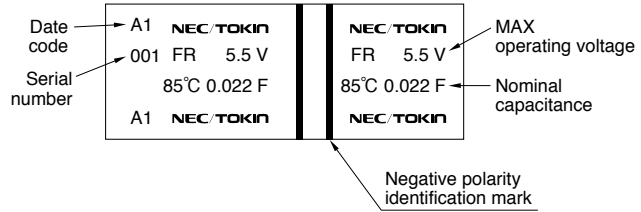

Specifications

Part Number	MAX operating voltage (Vdc)	Nominal capacitance		MAX ESR (at 1 kHz) (Ω)	MAX current at 30 min. (mA)	Voltage holding characteristics (V)	Dimension (unit:mm)						Weight (g)
		Charge system (F)	Discharge system (F)				ϕD	H	P	ℓ	d_1	d_2	
FR0H223ZF	5.5	0.022	0.028	220	0.033	4.2	11.5	14.0	5.08	2.7	0.4	1.2	2.3
FR0H473ZF	5.5	0.047	0.060	110	0.071	4.2	14.5	14.0	5.08	2.4	0.4	1.2	3.9
FR0H104ZF	5.5	0.10	0.15	150	0.15	4.2	14.5	15.5	5.08	2.4	0.4	1.2	4.3
FR0H224ZF	5.5	0.22	0.33	180	0.33	4.2	14.5	21.0	5.08	2.4	0.4	1.2	5.3
FR0H474ZF	5.5	0.47	0.75	100	0.71	4.2	16.5	21.5	5.08	2.7	0.4	1.2	7.5
FR0H105ZF	5.5	1.0	1.6	60	1.5	4.2	21.5	22.0	7.62	3.0	0.6	1.2	13.3



- All specifications in this catalog and production status of products are subject to change without notice. Prior to the purchase, please contact NEC TOKIN for updated product data.
- Please request for a specification sheet for detailed product data prior to the purchase.
- Before using the product in this catalog, please read "Precautions" and other safety precautions listed in the printed version catalog.

6.7 FS Series

Dimensions

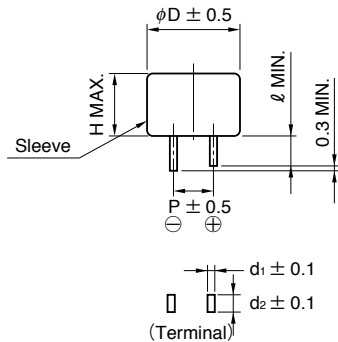

Markings on sleeve

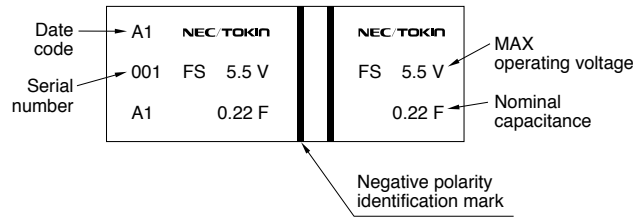

Specifications

Part Number	MAX operating voltage (Vdc)	Nominal capacitance		MAX ESR (at 1 kHz) (Ω)	MAX current at 30 min. (mA)	Dimension (unit:mm)						Weight (g)
		Charge system (F)	Discharge system (F)			ϕD	H	P	ℓ	d_1	d_2	
FS0H223ZF	5.5	0.022	0.033	60.0	0.033	11.5	8.5	5.08	2.7	0.4	1.2	1.6
FS0H473ZF	5.5	0.047	0.072	40.0	0.071	13.0	8.5	5.08	2.2	0.4	1.2	2.6
FS0H104ZF	5.5	0.10	0.15	25.0	0.15	16.5	8.5	5.08	2.7	0.4	1.2	4.1
FS0H224ZF	5.5	0.22	0.33	25.0	0.33	16.5	13.0	5.08	2.7	0.4	1.2	5.3
FS0H474ZF	5.5	0.47	0.75	13.0	0.71	21.5	13.0	7.62	3.0	0.6	1.2	10
FS0H105ZF	5.5	1.0	1.3	7.0	1.5	28.5	14.0	10.16	6.1	0.6	1.4	18
FS1A474ZF	11.0	0.47	0.60	7.0	1.41	28.5	25.5	10.16	6.1	0.6	1.4	32
FS1A105ZF	11.0	1.0	1.3	7.0	3.0	28.5	31.5	10.16	6.1	0.6	1.4	35
FS1B105ZF	12.0	1.0	1.3	7.5	3.6	28.5	38.0	10.16	6.1	0.6	1.4	40
FS1B505ZF	12.0	5.0	6.5	4.0	18.0	44.8	60.0	20.00	9.5	1.0	1.4	160



- All specifications in this catalog and production status of products are subject to change without notice. Prior to the purchase, please contact NEC TOKIN for updated product data.
- Please request for a specification sheet for detailed product data prior to the purchase.
- Before using the product in this catalog, please read "Precautions" and other safety precautions listed in the printed version catalog.

Specifications

Item	Series name	FS type	Test conditions (conforming to JIS C 5160-1)
Category temperature range		-25 °C to +70 °C	
MAX operating voltage		5.5Vdc, 11Vdc, 12Vdc	
Capacitance		5.5V : 0.022F to 1.0F 11V : 0.47, 1.0 12V : 1.0F, 5.0F	Refer to "Measurement Conditions"
Capacitance allowance		+80 %, -20 %	Refer to "Measurement Conditions"
ESR		5.5V : 0.0022F to 1.0F 11V : 0.47F, 1.0F 12V : 1.0F, 5.0F	Measured at 1kHz, 10mA ; See also "Measurement Conditions"
Current (30-minutes value)		Refer to standard ratings	Refer to "Measurement Conditions"
Surge	Capacitance	More than 90% of initial ratings	Surge voltage : 6.3V (5.5V type) : 12.6V (11V type) : 13.6V (12V type) Charge : 30 sec. Discharge : 9min 30sec. Number of cycles : 1000 Series resistance : 0.022F 560Ω : 0.047F 300Ω : 0.10F 150Ω : 0.22F 56Ω : 0.47F 30Ω : 1.0F 15Ω : 5.0F 10Ω Discharge resistance : 0Ω Temperature : 70±2°C
	ESR	Not to exceed 120% of initial ratings	
	Current (30 minutes value)	Not to exceed 120% of initial ratings	
	Appearance	No obvious abnormality	
Characteristics in different temperature	Capacitance	Phase 2	50% or higher than initial value
	ESR		300% or less than initial value
	Capacitance	Phase 3	
	ESR		
	Capacitance	Phase 5	150% or less than initial value
	ESR		Satisfy initial ratings
	Current (30 minutes value)		1.5CV (mA) or below
	Capacitance	Phase 6	Within ±20% of initial value
	ESR		Satisfy initial ratings
Current (30 minutes value)	Satisfy initial ratings		
Lead strength (tensile)		No terminal damage	Conforms to 4.9
Vibration resistance	Capacitance	Satisfy initial ratings	Conforms to 4.13 Frequency : 10 to 55 Hz Testing time : 6 hours
	ESR		
	Current (30 minutes value)		
	Appearance	No obvious abnormality	
Solderability		Over 3/4 of the terminal should be covered by the new solder	Conforms to 4.11 Solder temp : 245±5°C Dipping time : 5±0.5 sec. 1.6mm from the bottom should be dipped.
Solder heat resistance	Capacitance	Satisfy initial ratings	Conforms to 4.10 Solder temp : 260±10°C Dipping time : 10±1 sec. 1.6mm from the bottom should be dipped.
	ESR		
	Current (30 minutes value)		
	Appearance		
Temperature cycle	Capacitance	Satisfy initial ratings	Conforms to 4.12 Temperature condition : -25°C →Room temperature→ +70°C →Room temperature Number of cycles : 5 Cycles
	ESR		
	Current (30 minutes value)		
	Appearance		
High temp. and high humidity resistance	Capacitance	Over 90% of the initial value (5.5V type) Within ±20% of initial value (11V type, 12Vtype)	Conforms to 4.14 Temperature : 40±2°C Relative humidity : 90 to 95 %RH Testing time : 240±8 hours
	ESR	Not to exceed 120% of initial ratings	
	Current (30 minutes value)	Not to exceed 120% of initial ratings	
	Appearance	No obvious abnormality	
High temperature load	Capacitance	Over 85% of the initial value (5.5V type) Within ±20% of initial value (11V type, 12Vtype)	Conforms to 4.15 Temperature : 70±2°C Voltage applied : MAX operating voltage Series protection resistance : 0Ω Testing time : 1000 ^h Hours
	ESR	Below 200% of initial ratings	
	Current (30 minutes value)	Below 200% of initial ratings	
	Appearance	No obvious abnormality	



- All specifications in this catalog and production status of products are subject to change without notice. Prior to the purchase, please contact NEC TOKIN for updated product data.
- Please request for a specification sheet for detailed product data prior to the purchase.
- Before using the product in this catalog, please read "Precautions" and other safety precautions listed in the printed version catalog.

6.8 FA Series, FE Series

● FA Series

Dimensions

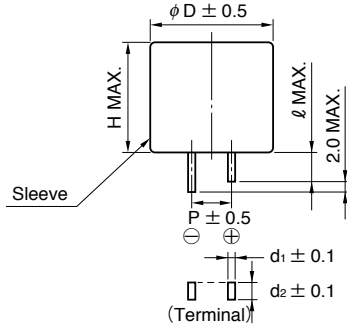

Markings on sleeve

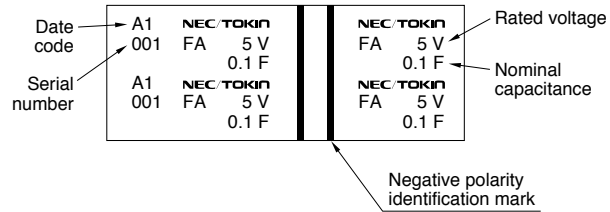

Specifications

Part Number	MAX operating voltage (Vdc)	Rated voltage (Vdc)	Nominal capacitance		MAX ESR (at 1 kHz) (Ω)	MAX current at 30 min. (mA)	Dimension (unit:mm)						Weight (g)
			Charge system (F)	Discharge system (F)			ϕD	H	P	ℓ	d_1	d_2	
FA0H473ZF	5.5	5	0.047	0.075	20.0	0.071	16.0	15.5	5.1	5.0	0.4	1.2	6.2
FA0H104ZF	5.5	5	0.10	0.16	8.0	0.15	21.5	15.5	7.6	5.5	0.6	1.2	12
FA0H224ZF	5.5	5	0.22	0.35	5.0	0.33	28.5	16.5	10.2	9.5	0.6	1.4	25
FA0H474ZF	5.5	5	0.47	0.75	3.5	0.71	36.5	16.5	15.0	9.5	0.6	1.7	42
FA0H105ZF	5.5	5	1.0	1.6	2.5	1.5	44.5	18.5	20.0	9.5	1.0	1.4	65
FA1A223ZF	11.0	10	0.022	0.035	20.0	0.066	16.0	25.0	5.1	5.0	0.4	1.2	7.5
FA1A104ZF	11.0	10	0.10	0.16	8.0	0.30	28.5	25.5	10.2	9.5	0.6	1.4	32
FA1A224ZF	11.0	10	0.22	0.35	6.0	0.66	36.5	27.5	15.0	9.5	1.0	1.4	55
FA1A474ZF	11.0	10	0.47	0.75	4.0	1.41	44.5	28.5	20.0	9.5	1.0	1.4	83

● FE Series

Dimensions

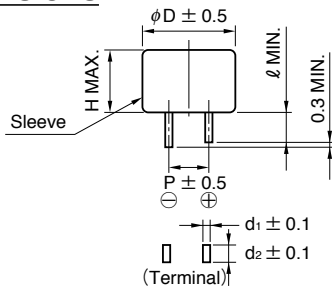

Markings on sleeve

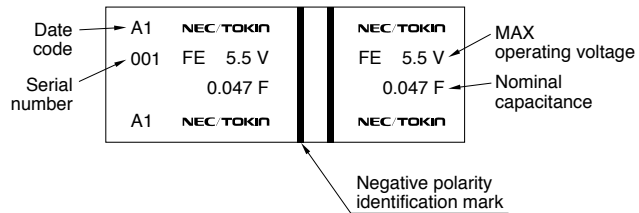

Specifications

Part Number	MAX operating voltage (Vdc)	Nominal capacitance		MAX ESR (at 1 kHz) (Ω)	MAX current at 30 min. (mA)	Dimension (unit:mm)						Weight (g)
		Charge system (F)	Discharge system (F)			ϕD	H	P	ℓ	d_1	d_2	
FE0H473ZF	5.5	0.047	0.075	14.0	0.071	14.5	14.0	5.1	2.2	0.4	1.2	3.9
FE0H104ZF	5.5	0.10	0.16	6.5	0.15	16.5	14.0	5.1	2.7	0.4	1.2	5
FE0H224ZF	5.5	0.22	0.35	3.5	0.33	21.5	15.5	7.6	3.0	0.6	1.2	9.5
FE0H474ZF	5.5	0.47	0.75	1.8	0.71	28.5	16.5	10.2	6.1	0.6	1.4	16
FE0H105ZF	5.5	1.0	1.4	1.0	1.5	36.5	18.5	15.0	6.1	0.6	1.7	38
FE0H155ZF	5.5	1.5	2.1	0.6	2.3	44.5	18.5	20.0	6.1	1.0	1.4	72



- All specifications in this catalog and production status of products are subject to change without notice. Prior to the purchase, please contact NEC TOKIN for updated product data.
- Please request for a specification sheet for detailed product data prior to the purchase.
- Before using the product in this catalog, please read "Precautions" and other safety precautions listed in the printed version catalog.

Specifications

Item	Series name	FA	FE	Test conditions (conforming to JIS C 5160-1)		
Category temperature range		-25 °C to +70 °C	-40 °C to +70 °C			
MAX operating voltage		5.5Vdc, 11Vdc	5.5Vdc			
Capacitance		5.5V : 0.047F to 1.0F 11V : 0.022F to 0.47F	0.047F to 1.5F	Refer to "Measurement Conditions"		
Capacitance allowance		+80 %, -20 %	+80 %, -20 %	Refer to "Measurement Conditions"		
ESR		Refer to standard ratings	Refer to standard ratings	Measured at 1kHz, 10mA ; See also "Measurement Conditions"		
Current (30-minutes value)		Refer to standard ratings	Refer to standard ratings	Refer to "Measurement Conditions"		
Surge	Capacitance	/	More than 90% of initial ratings	Surge voltage : 6.3V (5.5V type) : 12.6V (11V type) Charge : 30 sec. Discharge : 9min 30sec. Number of cycles : 1000 Series resistance : 0.047F : 0.10F : 0.22F : 0.47F : 1.0F, 1.5F Discharge resistance : 0Ω Temperature : 70±2 °C		
	ESR		Not to exceed 120% of initial ratings			
	Current (30 minutes value)		Not to exceed 120% of initial ratings			
	Appearance		No obvious abnormality			
Characteristics in different temperature	Capacitance	Phase 2	70% or higher than initial value	Conforms to 4.17 Phase1 : +25±2 °C Phase2 : -25±2 °C Phase3 : -40±2 °C (FE type) Phase4 : +25±2 °C Phase5 : +70±2 °C Phase6 : +25±2 °C		
	ESR	2	300% or less than initial value			
	Capacitance	Phase 3	/		Phase 3	40% or higher than initial value
	ESR	3			400% or less than initial value	
	Capacitance	Phase 5	150% or less than initial value		Phase 5	200% or less than initial value
	ESR		Satisfy initial ratings		5	Satisfy initial ratings
	Current (30 minutes value)	5	1.5CV (mA) or below		5	1.5CV (mA) or below
Capacitance	Phase 6	Within ±20% of initial value	Phase 6	Within ±20% of initial value		
ESR		Satisfy initial ratings	6	Satisfy initial ratings		
Current (30 minutes value)		Satisfy initial ratings	6	Satisfy initial ratings		
Lead strength (tensile)		No terminal damage	No terminal damage	Conforms to 4.9		
Vibration resistance	Capacitance	Satisfy initial ratings	Satisfy initial ratings	Conforms to 4.13 Frequency : 10 to 55 Hz Testing time : 6 hours		
	ESR					
	Current (30 minutes value)					
	Appearance				No obvious abnormality	No obvious abnormality
Solderability		Over 3/4 of the terminal should be covered by the new solder	Over 3/4 of the terminal should be covered by the new solder	Conforms to 4.11 Solder temp : 245±5 °C Dipping time : 5±0.5 sec. 1.6mm from the bottom should be dipped.		
Solder heat resistance	Capacitance	Satisfy initial ratings	Satisfy initial ratings	Conforms to 4.10 Solder temp : 260±10 °C Dipping time : 10±1 sec. 1.6mm from the bottom should be dipped.		
	ESR					
	Current (30 minutes value)					
	Appearance				No obvious abnormality	No obvious abnormality
Temperature cycle	Capacitance	Satisfy initial ratings	Satisfy initial ratings	Conforms to 4.12 Temperature condition : -25 °C (-40 °C for FE type)→ Room temperature→ +70 °C →Room temperature Number of cycles : 5 Cycles		
	ESR					
	Current (30 minutes value)					
	Appearance				No obvious abnormality	No obvious abnormality
High temp. and high humidity resistance	Capacitance	Over 90% of initial value	Within ±20% of initial value	Conforms to 4.14 Temperature : 40±2 °C Relative humidity : 90 to 95 %RH Testing time : 240±8 hours		
	ESR	Not to exceed 120% of initial ratings	Not to exceed 120% of initial ratings			
	Current (30 minutes value)	Not to exceed 120% of initial ratings	Not to exceed 120% of initial ratings			
	Appearance	No obvious abnormality	No obvious abnormality			
High temperature load	Capacitance	Over 85% of initial value	Within ±30% of initial value	Conforms to 4.15 Temperature : 70±2 °C Voltage applied : MAX operating voltage Series protection resistance : 0 Ω Testing time : 1000 ^{±10%} Hours		
	ESR	Below 120% of initial ratings	Below 200% of initial ratings			
	Current (30 minutes value)	Below 200% of initial ratings	Below 200% of initial ratings			
	Appearance	No obvious abnormality	No obvious abnormality			



- All specifications in this catalog and production status of products are subject to change without notice. Prior to the purchase, please contact NEC TOKIN for updated product data.
- Please request for a specification sheet for detailed product data prior to the purchase.
- Before using the product in this catalog, please read "Precautions" and other safety precautions listed in the printed version catalog.

6.9 HV Series (High capacitance Type)

Markings on sleeve

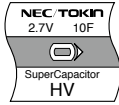

Dimensions

(1) $\phi 8 \sim \phi 18$

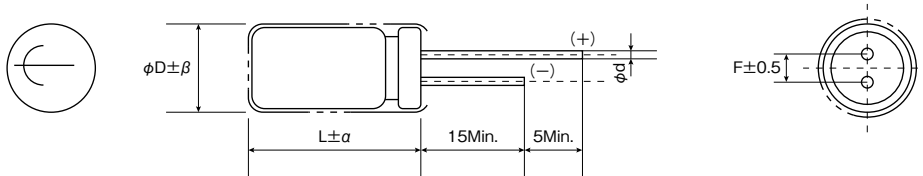

(2) $\phi 25 \sim \phi 35$

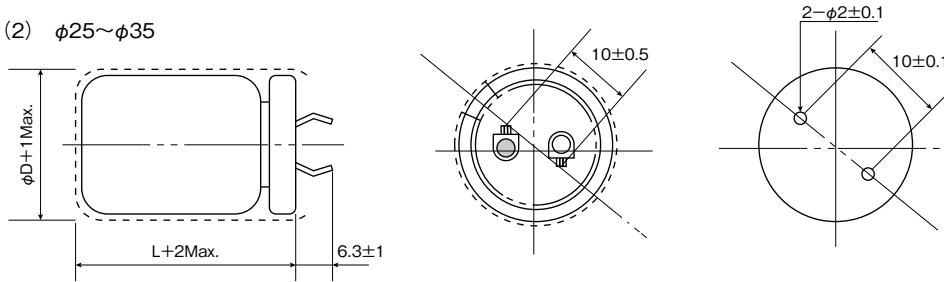

Terminal Details

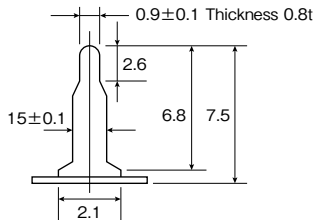

Standard models

Part Number	MAX operating voltage (Vdc)	Nomical capacitance (F)	MAX ESR (at 1kHz) (mΩ)	MAX current at 30 min. (mA)	Dimension (unit:mm)						Weight (g)
					ϕD	L	F	d	β	a	
HVZ0E105NF	2.7	1.0	300	0.8	8.0	12.0	3.5	0.6	0.5	2.0	1.0
HVZ0E275NF	2.7	2.7	300	2.2	8.0	22.0	3.5	0.6	0.5	2.0	1.9
HVZ0E475NF	2.7	4.7	100	3.8	10.0	20.0	5.0	0.6	0.5	2.0	2.5
HVZ0E106NF	2.7	10.0	100	8.0	10.0	35.0	5.0	0.6	0.5	2.0	4.0
HVZ0E226NF	2.7	22.0	100	18.0	12.5	35.0	5.0	0.6	0.5	2.0	10.0
HVZ0E506NF	2.5	50.0	50	40.0	18.0	40.0	7.5	0.8	0.5	2.0	14.0
HVZ0E107NF-LT	2.7	100.0	30	81.0	25.0	50.0	—	—	—	—	28.0
HVZ0E207NF-LT	2.7	200.0	30	162.0	35.0	50.0	—	—	—	—	61.5



● All specifications in this catalog and production status of products are subject to change without notice. Prior to the purchase, please contact NEC TOKIN for updated product data.
 ● Please request for a specification sheet for detailed product data prior to the purchase.
 ● Before using the product in this catalog, please read "Precautions" and other safety precautions listed in the printed version catalog.

Specifications

Items		Specification	Test Condition Conforming JIS C 5160- 2
Operating Temperature Range		-25 °C ~ +60 °C (22F, 50F, 100F, 200F) -25 °C ~ +70 °C (1.0F, 2.7F, 4.7F, 10F)	
Maximum Operating Voltage		2.7Vdc (50F type has 2.5Vdc)	
Nominal Capacitance		1.0F, 2.7F, 4.7F, 10F, 22F, 50F, 100F, 200F	
Capacitance Allowance		±30%	
Equivalent Series Resistance (ESR)		Showing Standard list	
Current at 30 minutes		Showing Standard list	
Temperature variation of characteristic	Phase 4	Capacitance	More than 70% of initial value
		ESR	Not exceed 5 times of initial value
		Capacitance	Not exceed 150% of initial value
		ESR	Meet initial standard value
	Phase 5	Current at 30min	Not exceed 1.5CV(mA)
		Capacitance	Within ±20% of initial
		ESR	Meet initial standard value
		Current at 30min	Meet initial standard value
Lead strength		No pin disconnection	Conforms to 4.5
Vibration Resistance	Capacitance	Meet initial standard value	Conforms to 4.9 Frequency :10~55Hz Test Duration :6 hours
	ESR		
	Current at 30min		
	Appearance	No obvious abnormality	
Solderability		3/4 or more of pin surface Should be covered with new solder	Conforms to 4.7 Temperature: 245±5 °C, Time: 5±0.5second Should be dipped up to 1.6mm from lower end of Capacitor
Solder Heat Resistance	Capacitor	Meet initial standard value	Conforms to 4.6 Temperature: 245±5 °C, Time: 5±0.5second Should be dipped up to 1.6mm from lower end of Capacitor
	ESR		
	Current at 30minutes		
	Appearance	No obvious abnormality	
Temperature Cycle	Capacitor	Meet initial standard value	Conforms to 4.8 -25 °C →Room Temp →*Max. Temp. →Room Temp 5 cycles * Max. Temperature
	ESR		
	Current at 30minutes		
	Appearance	No obvious abnormality	
Humidity Resistance	Capacitor	Within ±20% of initial value	Conforms to 4.14 40±2 °C 90~90%RH, 240±8hours
	ESR	Not exceed 1.5 times of initial value	
	Current at 30minutes	Not exceed 1.5 times of initial value	
	Appearance	No obvious abnormality	
High Temperature Load Life	Capacitor	Within ±30% of initial value	Conforms to 4.10 Max. Operation temperature ±2 °C Max. Operating Voltage Series protection resistance : 0.Ω 10001000 ±hours Max Operation Temp
	ESR	Not exceed 2 times of initial value	
	Current at 30minutes	Not exceed 2 times of initial value	
	Appearance	No obvious abnormality	



- All specifications in this catalog and production status of products are subject to change without notice. Prior to the purchase, please contact NEC TOKIN for updated product data.
- Please request for a specification sheet for detailed product data prior to the purchase.
- Before using the product in this catalog, please read "Precautions" and other safety precautions listed in the printed version catalog.

7. Packing

1. FM Series

(1) Bulk

- Packing method : Pack in vinyl bags then pack them into cardboard boxes.
- Standard packing quantity : 1000pcs (100pcs / vinyl bag × 10)
However : FM0H104ZF-L1 and FM0H224ZF-L1=800pcs, FMC0H334ZF=400pcs, FMC0H334ZF-L1=300pcs

(2) Taping

- Packing method : Ammo pack
- Standard packing quantity : 1000pcs However, FMC0H334ZFTP() = 400pcs

2. FC Series

Part name	Packing unit
FC0H473ZFTBR24	1000 PCS. / reel
FC0H104ZFTBR24	1000 PCS. / reel
FC0H224ZFTBR24	500 PCS. / reel
FC0H474ZFTBR32-SS	200 PCS. / reel
FC0H105ZFTBR44-SS	150 PCS. / reel
FC0V104ZFTBR24	1000 PCS. / reel
FC0V224ZFTBR24	1000 PCS. / reel
FC0V474ZFTBR24	500 PCS. / reel
FCS0H473ZFTBR24	1000 PCS. / reel
FCS0H104ZFTBR24	1000 PCS. / reel
FCS0H224ZFTBR24	500 PCS. / reel
FCS0V104ZFTBR24	1000 PCS. / reel
FCS0V224ZFTBR24	1000 PCS. / reel
FCS0V474ZFTBR24	500 PCS. / reel

3. FG, FT, FS, FR, FY, FA Series

(1) Bulk (Small type)

- Packing method : Pack in vinyl bags then pack them into cardboard boxes.
- Standard packing quantity: see chart below.

(Unit : Pises)

Series name Capacitance	FA		FE	FS			FY			FR	FG	FT
	5.5V type	11V type		5.5V type	11V type, 12V type	FYD	FYH	FYL				
0.010F	—	—	—	—	—	—	—	2000	—	2000	—	
0.022F	—	240	—	1000	—	1000	1600	2000	800	2000	—	
0.047F	400	—	400	800	—	1000	800	1600	400	2000	—	
0.10F	—	—	400	600	—	800	600	—	400	1600	1000	
0.22F	—	—	—	400	—	400	500	—	300	800	400	
0.47F	—	—	—	—	—	240	—	—	240	300	400	
1.0F	—	—	—	—	—	—	—	—	—	240	—	

(2) Bulk (large type)

- Packing method: Pin the terminal onto a conductive mat; then pack it into individual cardboard box with insulation material.
- Standard packing quantity: see chart below.

(Unit : Pises)

Series name Capacitance	FA		FE	FS			FY			FR	FG	FT
	5.5V type	11V type		5.5V type	11V type, 12V type	FYD	FYH	FYL				
0.10F	90	50	—	—	—	—	—	—	—	—	—	
0.22F	50	30	90	—	—	—	—	—	—	—	—	
0.47F	30	20	50	90	50	—	90	—	—	—	—	
1.0F	20	—	30	50	50	90	50	—	90	—	90	
1.4F	—	—	—	—	—	90	—	—	—	—	—	
1.5F	—	—	20	—	—	—	—	—	—	160	—	
2.2F	—	—	—	—	—	50	—	—	—	90	50	
3.3F	—	—	—	—	—	—	—	—	—	—	30	
4.7F	—	—	—	—	—	—	—	—	—	50	—	
5.0F	—	—	—	—	20	—	—	—	—	—	—	
5.6F	—	—	—	—	—	—	—	—	—	—	20	

4. Winded type (HV Series)

- Packing method : Pack in vinyl bags then pack them into cardboard boxes.
- Standard packing quantity : 10,000pcs(1F), 5,000pcs(2.7F, 4.7F), 4,000pcs(10F), 1,500pcs(22F), 750pcs(50F), 200pcs(100F, 200F)



● All specifications in this catalog and production status of products are subject to change without notice. Prior to the purchase, please contact NEC TOKIN for updated product data.
● Please request for a specification sheet for detailed product data prior to the purchase.
● Before using the product in this catalog, please read "Precautions" and other safety precautions listed in the printed version catalog.

8. List of Plating Type and Sleeve Type

By changing the solder plating from leaded solder to lead-free solder, and the outer tube material of can-cased conventional SuperCapacitor from polyvinyl chloride to Polyethylene Terephthate (PET), our new SuperCapacitor has now become even more friendlier to the environment.

- a. Iron + copper base + lead-free solder plating (Sn-1Cu)
- b. SUS nickel base + copper base + reflow lead-free solder plating (100% Sn, reflow processed)
- c. Iron + copper base + lead-free solder plating (100% Sn)

Series	Part Number	Plating	Sleeve
FA	All FA Series	a	PET (Blue)
FE	All FE Series	a	PET (Blue)
FS	All FS Series	a	PET (Blue)
FR	All FR Series	a	PET (Blue)
FT	All FT Series	a	PET (Blue)
FY	All FYD type	a	PET (Blue)
	All FYH type	a	PET (Blue)
	FYL0H473ZF	a	PET (Blue)
	FYL0H223ZF	b	PET (Blue)
FG	FYL0H103ZF	b	PET (Blue)
	FG0H223ZF	b	PET (Blue)
	FG0H473ZF	b	PET (Blue)
	FG0H104ZF	b	PET (Blue)
	FG0H224ZF	a	PET (Blue)
	FG0H474ZF	a	PET (Blue)
	FG0H105ZF	a	PET (Blue)
	FG0H225ZF	a	PET (Blue)
	FG0H475ZF	a	PET (Blue)
	FGH0H104ZF	b	PET (Blue)
	FGH0H224ZF	b	PET (Blue)
	FGH0H474ZF	a	PET (Blue)
	FGH0H105ZF	a	PET (Blue)
	All FGR type	a	PET (Blue)
FM	All FM Series	a	No tube used
FC	FC0H473ZFTBR24	b	No tube used
	FC0H104ZFTBR24	b	No tube used
	FC0H224ZFTBR24	b	No tube used
	FC0H474ZFTBR32-SS	a	No tube used
	FC0H105ZFTBR44-SS	a	No tube used
	FC0V104ZFTBR24	b	No tube used
	FC0V224ZFTBR24	b	No tube used
	FC0V474ZFTBR24	b	No tube used
	FCS0H473ZFTBR24	b	No tube used
	FCS0H104ZFTBR24	b	No tube used
	FCS0H224ZFTBR24	b	No tube used
	FCS0V104ZFTBR24	b	No tube used
	FCS0V224ZFTBR24	b	No tube used
FCS0V474ZFTBR24	b	No tube used	
HV	All HV Series	c	PET (Blue)

Recommended Pb-free solder : Sn / 3.5Ag / 0.75Cu

Sn / 3.0Ag / 0.5Cu

Sn / 0.7Cu

Sn / 2.5Ag / 1.0Bi / 0.5Cu



- All specifications in this catalog and production status of products are subject to change without notice. Prior to the purchase, please contact NEC TOKIN for updated product data.
- Please request for a specification sheet for detailed product data prior to the purchase.
- Before using the product in this catalog, please read "Precautions" and other safety precautions listed in the printed version catalog.

9. Measurement Conditions

(1) Capacitance (Charge System)

Capacitance is calculated from expression (9) by measuring the charge time constant (τ) of the capacitor (C). Prior to measurement, short between both pins of the capacitor for 30 minutes or more to let it discharge. In addition, follow the indication of the product when determining the polarity of the capacitor during charging.

$$\text{Capacitance: } C = \frac{\tau}{R_c} \text{ (F)} \quad (9)$$

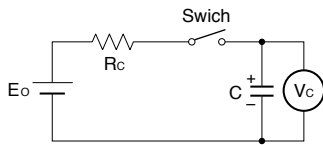

- Eo: 3.0 (V) ... Product with maximum operating voltage 3.5 V
- 5.0 (V) ... Product with maximum operating voltage 5.5 V
- 6.0 (V) ... Product with maximum operating voltage 6.5 V
- 10.0 (V) ... Product with maximum operating voltage 11 V
- 12.0 (V) ... Product with maximum operating voltage 12 V

τ : Time from start of charging until Vc becomes 0.632Eo (V) (sec)

Rc: See table below (Ω).

	FA	FE	FS	FY			FR	FM, FME FMR, FML	FMC	FG FGR	FGH	FT	FC, FCS
				FYD	FYH	FYL							
0.010F	-	-	-	-	-	5000 Ω	-	5000 Ω	-	5000 Ω	-	-	-
0.022F	1000 Ω	-	1000 Ω	2000 Ω	2000 Ω	2000 Ω	2000 Ω	2000 Ω	-	2000 Ω	-	-	Discharge
0.033F	-	-	-	-	-	-	-	Discharge	-	-	-	-	-
0.047F	1000 Ω	1000 Ω	1000 Ω	2000 Ω	1000 Ω	2000 Ω	1000 Ω	2000 Ω	1000 Ω	2000 Ω	-	-	-
0.10F	510 Ω	510 Ω	510 Ω	1000 Ω	510 Ω	-	1000 Ω	1000 Ω	1000 Ω	1000 Ω	Discharge	510 Ω	Discharge
0.22F	200 Ω	200 Ω	200 Ω	510 Ω	510 Ω	-	510 Ω	0H: Discharge 0V: 1000 Ω	-	1000 Ω	Discharge	200 Ω	Discharge
0.33F	-	-	-	-	-	-	-	-	Discharge	-	-	-	-
0.47F	100 Ω	100 Ω	100 Ω	200 Ω	200 Ω	-	200 Ω	-	-	1000 Ω	Discharge	100 Ω	Discharge
1.0F	51 Ω	51 Ω	100 Ω	100 Ω	100 Ω	-	100 Ω	-	-	510 Ω	Discharge	100 Ω	Discharge
1.4F	-	-	-	200 Ω	-	-	-	-	-	-	-	-	-
1.5F	-	51 Ω	-	-	-	-	-	-	-	510 Ω	-	-	-
2.2F	-	-	-	100 Ω	-	-	-	-	-	200 Ω	-	51 Ω	-
3.3F	-	-	-	-	-	-	-	-	-	-	-	51 Ω	-
4.7F	-	-	-	-	-	-	-	-	-	100 Ω	-	-	-
5.0F	-	-	100 Ω	-	-	-	-	-	-	-	-	-	-
5.6F	-	-	-	-	-	-	-	-	-	-	-	20 Ω	-

*Capacitance values according to the constant current discharge method.

*HV series capacitance is measured by discharge system.

Table 3 Capacitance measurement

Capacitance (Discharge System)

In the diagram below, charging is performed for a duration of 30 minutes, once the voltage of the condenser terminal reaches 5.5 V.

Then, use a constant current load device and measure the time for the terminal voltage to drop from 3.0 to 2.5 V upon discharge at 0.22 mA for 0.22 F, for example, and calculate the static capacitance according to the equation shown below.

Note: The current value is 1 mA discharged per 1F.

$$\text{Capactance : } C = \frac{I \times (T_2 - T_1)}{V_1 - V_2} \text{ (F)}$$

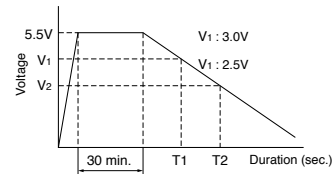
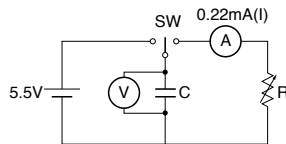

- All specifications in this catalog and production status of products are subject to change without notice. Prior to the purchase, please contact NEC TOKIN for updated product data.
- Please request for a specification sheet for detailed product data prior to the purchase.
- Before using the product in this catalog, please read "Precautions" and other safety precautions listed in the printed version catalog.

Capacitance (Discharge System:3.5V)

In the diagram below, charging is performed for a duration of 30 minutes, once the voltage of the capacitor terminal reaches 3.5V. Then, use a constant current load device and measure the time for the terminal voltage to drop from 1.8 to 1.5V upon discharge at 1 mA per 1F, and calculate the static capacitance according to the equation shown below.

$$C = \frac{I \times (T_2 - T_1)}{V_1 - V_2} \quad (F)$$

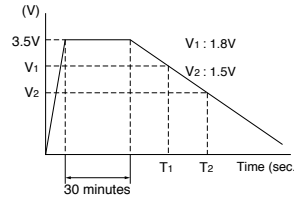
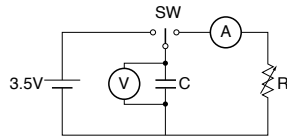

Capacitance (Discharge System:HVseries)

In the diagram below, charging is performed for a duration of 30 minutes, once the voltage of the capacitor terminal reaches Max. operating voltage.

Then, use a constant current load device and measure the time for the terminal voltage to drop from 2.0 to 1.5V upon discharge at 1 mA per 1F, and calculate the static capacitance according to the equation shown below.

$$C = \frac{I \times (T_2 - T_1)}{V_1 - V_2} \quad (F)$$

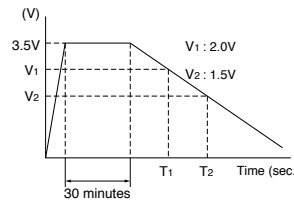
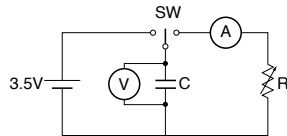

Equivalent series resistance (ESR)

ESR shall be calculated from the equation below.

$$ESR = \frac{V_C}{0.01} \quad (\Omega)$$

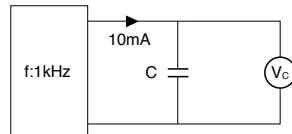

Current (at 30 minutes after charging)

Current shall be calculated from the equation below.

Prior to measurement, both lead terminals must be short-circuited for a minimum of 30 minutes.

The lead terminal connected to the metal can case is connected to the negative side of the power supply.

- Eo : 2.5Vdc (HVseries 50F)
- 2.7Vdc (HVseries except 50F)
- 3.0Vdc (3.5V type)
- 5.0Vdc (5.5V type)
- Rc : 1000Ω (0.010F, 0.022F, 0.047F)
- 100Ω (0.10F, 0.22F, 0.47F)
- 10Ω (1.0F, 1.5F, 2.2F, 4.7F)
- 2.2Ω (HVseries)

$$\text{Current} = \frac{V_R}{R_C} \quad (A)$$

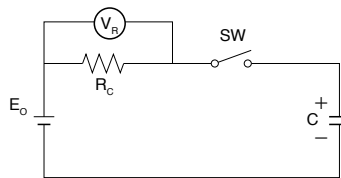

Self-discharge characteristic (0H: 5.5V products)

The self-discharge characteristic is measured by charging a voltage of 5.0 Vdc (charge protection resistance: 0Ω) according to the capacitor polarity for 24 hours, then releasing between the pins for 24 hours and measuring the pin-to-pin voltage.

The test should be carried out in an environment with an ambient temperature of 25°C or below and relative humidity of 70% RH or below.



- All specifications in this catalog and production status of products are subject to change without notice. Prior to the purchase, please contact NEC TOKIN for updated product data.
- Please request for a specification sheet for detailed product data prior to the purchase.
- Before using the product in this catalog, please read "Precautions" and other safety precautions listed in the printed version catalog.

10. Notes on Using Super Capacitor (Electric Double-Layer Capacitor)

1. Circuitry design

1.1 Useful life

The electrical double layered capacitor (super capacitor) uses electrolyte and is sealed with rubber etc. Water in the electrolyte can evaporate in use over long periods at high temperatures, thus reducing electrostatic capacity which in turn will create greater internal resistance. The characteristics of the super capacitor can vary greatly depending on the environment it is used in. Therefore, controlling the usage environment will ensure prolonged life of the part.

Basic breakdown mode is an open mode due to increased internal resistance.

1.2 Fail rate in the field

Based on field data, the fail rate is calculated at approx. 0.006Fit. We estimate that unreported failures are ten times this amount. Therefore, we assume that the fail rate is below 0.06Fit.

1.3 Voltage application when maximum usable voltage is exceeded

Performance may be compromised, and in some cases leakage or damage may occur if applied voltage exceeds maximum working voltage.

1.4 Use of capacitor as a smoothing capacitor (ripple absorption) in electrical circuits

As super capacitors contain a high level of internal resistance, they are not recommended for use as electrical smoothing capacitors in electrical circuits.

Performance may be compromised, and in some cases leakage or damage may occur if a super capacitor is used in ripple absorption.

1.5 Series connections

As applied voltage balance to each super capacitor is lost when used in series connection, excess voltage may be applied to some super capacitors, which will not only negatively affect its performance but may also cause leakage and/or damage.

Allow ample margin for maximum voltage or attach a circuit for applying equal voltage to each super capacitor (partial pressure resistor/voltage divider) when using super capacitors in series connection.

Also, arrange super capacitors so that the temperature between each capacitor will not vary.

1.6 Outer sleeve insulation

The outer sleeve wrapped around the super capacitor indicates that it is sealed, however the outer sleeve is not guaranteed for insulation purposes. Therefore, it cannot be used where insulation is necessary.

1.7 Polar characteristics

The super capacitor is manufactured so that the terminal on the outer case is negative (-). Align the (-) symbol during use. Even though discharging has been carried out prior to shipping, any residual electrical charge may negatively affect other parts.

1.8 Use next to heat emitters

Useful life of the super capacitor will be significantly affected if used near heat emitting items (coils, power transistors, and posistors etc) where the super capacitor itself may become heated.

1.9 Usage environment

This device cannot be used in any acidic, alkaline or similar type of environment.



1.10 Super capacitors fitted with pressure valves

HV series super capacitors are fitted with pressure valves. Make an opening in the top of the pressure valve to avoid any damage to the super capacitor when the pressure valve is in use. Allow at least a 2mm opening for models with a diameter of ϕ 18mm or less, and at least a 3mm opening for models with a diameter of ϕ 22mm.

2. Mounting

2.1 Mounting onto a reflow furnace

Except for the FC series, it is not possible to mount this capacitor onto an IR / VPS reflow furnace. Do not immerse the capacitor into a soldering dip tank.

2.2 Flow soldering conditions

Keep solder under 260°C and soldering time to within 10 seconds when using the flow automatic soldering method. (Except for the FC and HV series)

2.3 Installation using a soldering iron

Care must be taken to prevent the soldering iron from touching other parts when soldering. Keep the tip of the soldering iron under 400°C and soldering time to within 3 seconds. Always make sure that the temperature of the tip is controlled. Internal capacitor resistance is likely to increase if the terminals are overheated.

2.4 Lead terminal processing

Do not attempt to bend or polish the capacitor terminals with sand paper etc. Soldering may not be possible if the metallic plating is removed from the top of the terminals.

2.5 Cleaning, Coating, and Potting

Except for the FM series, cleaning, coating, and potting must not be carried out. Consult us if this type of procedure is necessary.

Terminals should be dried at less than the maximum operating temperature after cleaning.

3. Storage

3.1 Temperature and Humidity

Make sure that the super capacitor is stored according to the following conditions: Temp.: 5~35°C (Standard 25), Humidity: 20~70% (Standard: 50%). Do not allow the build up of condensation through sudden temperature change.

3.2 Environment conditions

Make sure that there are no corrosive gasses like sulfur dioxide as penetration of the lead terminals is possible.

Always store this item in an area with low dust and dirt levels.

Make sure that the packaging will not be deformed through heavy loading, movement and/or knocks.

Keep out of direct sunlight, and away from radiation, static electricity, and magnetic fields.

3.3 Maximum storage period

This item may be stored up to one year from the date of delivery if stored at the conditions stated above.

This product should be safe to use even after being stored for over a 1 year period. However, depending on the storage conditions, we recommend that the soldering is checked.

4. Dismantling

There is a small amount of electrolyte stored within the capacitor. Do not attempt to dismantle as direct skin contact with the electrolyte will cause burning.

This product should be treated as industrial waste and not be disposed of by fire.



- All specifications in this catalog and production status of products are subject to change without notice. Prior to the purchase, please contact NEC TOKIN for updated product data.
- Please request for a specification sheet for detailed product data prior to the purchase.
- Before using the product in this catalog, please read "Precautions" and other safety precautions listed in the printed version catalog.

40 Super Capacitors Vol.13



- All specifications in this catalog and production status of products are subject to change without notice. Prior to the purchase, please contact NEC TOKIN for updated product data.
- Please request for a specification sheet for detailed product data prior to the purchase.
- Before using the product in this catalog, please read "Precautions" and other safety precautions listed in the printed version catalog.



- All specifications in this catalog and production status of products are subject to change without notice. Prior to the purchase, please contact NEC TOKIN for updated product data.
- Please request for a specification sheet for detailed product data prior to the purchase.
- Before using the product in this catalog, please read "Precautions" and other safety precautions listed in the printed version catalog.

42 Super Capacitors Vol.13



- All specifications in this catalog and production status of products are subject to change without notice. Prior to the purchase, please contact NEC TOKIN for updated product data.
- Please request for a specification sheet for detailed product data prior to the purchase.
- Before using the product in this catalog, please read "Precautions" and other safety precautions listed in the printed version catalog.

When using our products, the following precautions should be taken.

- (1) Safety designing of an apparatus or a system allowing for failures of electronic components used in the system

In general, failures will occur in electronic components at a certain probability. NEC TOKIN makes every effort to improve the quality and reliability of electronic component products. However, it is impossible to completely eliminate the probability of failures. Therefore, when using NEC TOKIN's electronic component products, systems should be carefully designed to ensure redundancy in the event of an accident which would result in injury or death, fire, or social damage, to ensure the prevention of the spread of fire, and the prevention of faulty operation. (Please refer to pre-cautions to be taken when using SuperCapacitor capacitors for the details of failures.)

- (2) Quality level of various kinds of parts, and equipment in which the parts can be utilized
Electronic components have a standard quality level unless otherwise specified.

NEC TOKIN classifies the level of quality of electronic component products into three levels, in order from a lower level, a standard quality level, a special quality level, and a custom quality level in which a customer individually specifies a quality assurance program. Each of the quality levels has recommended applications.

If a user wants to use the electronic parts having a standard quality level in applications other than the applications specified for the standard quality level, they should always consult a member of our company's sales staff before using the electronic parts.

Standard quality level	: Computers, office automation equipment, communications equipment, measuring instruments, AV equipment, household electrical appliances, machine tools, personal equipment, industrial robots
Special quality level	: Transportation equipment (automobiles, railways, shipping, or the like), traffic signals, disaster prevention/crime prevention systems, safety devices, and medical equipment which is not directly intended for life-support purposes
Custom quality level	: Equipment for airplanes, aerospace equipment, nuclear power control systems, and medical equipment, apparatus or systems for life-support purposes

Unless otherwise shown, the quality level of NEC TOKIN's electronic component products included in documents such as catalogues, data sheets or data books is the standard quality level.

- (3) This manual is subject to change without notice.

The contents of this manual are based on data which is correct as of June 2013, and they may be changed without notice. If our products are used for mass-production design, please consult with a member of our company's sales staff by way of precaution.

- (4) Reprinting and copying of this manual without prior written permission from NEC TOKIN Corporation are not permitted.

- (5) Industrial property problems

In the event any problems associated with industrial property of a third party arising as a result of the use of our products, NEC TOKIN assumes no responsibility for problems other than problems directly associated with the constitution and manufacturing method of the products.

- (6) Should any of these products come under the category of strategic goods or services (according to Japan's foreign trade and foreign exchange regulations), the sender must obtain an export license from the Japanese Government before said products can be exported outside Japan.



- All specifications in this catalog and production status of products are subject to change without notice. Prior to the purchase, please contact NEC TOKIN for updated product data.
- Please request for a specification sheet for detailed product data prior to the purchase.
- Before using the product in this catalog, please read "Precautions" and other safety precautions listed in the printed version catalog.