



# TAOGLAS®



# Datasheet

## AccuraUWB FXUWB10

**Part No:**  
FXUWB10.07.0100C

### Description:

AccuraUWB Flex Series 3~10GHz Ultra-Wide Band (UWB) Flex Antenna with 100mm 1.37mm IPEX MHFHT

### Features:

- Flexible UWB Antenna
- Mounting on non-metal surfaces
- For European and USA UWB Applications
- For Channels 1-15
- Frequency: 3.0–10.3GHz
- Cable: 100mm 1.37 Coaxial
- Connector: IPEX MHFHT (U.FL compatible)
- Dimensions: 34.9\*24.5\*0.24mm
- RoHS & REACH Compliant

1. Introduction	3
2. Specifications	4
3. Antenna Characteristics	10
4. Radiation Patterns	15
5. Mechanical Drawing	17
6. Footprint	18
7. Packaging	19
<hr/>	
Changelog	20

Taoglas makes no warranties based on the accuracy or completeness of the contents of this document and reserves the right to make changes to specifications and product descriptions at any time without notice. Taoglas reserves all rights to this information contained herein. Reproduction, use or disclosure to third parties without express permission is strictly prohibited.



## 1. Introduction



The AccuraUWB FXUWB10 flexible polymer antenna, at 35\*24.5\*0.2 mm, is a small form factor, ultra-thin Ultra-Wideband (UWB) antenna with high efficiencies across the pulsed UWB communications operational bands. It is assembled by a simple “peel and stick” process, attaching securely to non-metal surfaces via 3M adhesive. It enables designers to use only one antenna that covers all available UWB commercial bands, namely bands 1 through 15 simultaneously.

The AccuraUWB antenna is a durable flexible polymer antenna that has an average peak gain of 5dBi, an efficiency of more than 75% across the bands and is designed to be mounted directly onto a plastic cover. It is an ideal choice for any device maker that needs to keep manufacturing costs down over the lifetime of a product. It is ground plane independent and delivered with a cable and connector for easy connecting to the wireless module or customer PCB. Cables and Connectors are customizable, however, the maximum microcoax cable length is 100 mm. Like all such antennas, care should be taken to mount the antenna at least 10mm from metal components or surfaces, and ideally, 20mm for best radiation efficiency.

Like all such antennas, care should be taken to mount the antenna at least 10mm from metal components or surfaces, and ideally, 20mm for best radiation efficiency.

Ultra-wideband (also known as UWB) is a low-power digital wireless technology for transmitting large amounts of digital data over a wide spectrum of frequency bands typically spanning more than 500MHz with very low power for short distances.

While the cable type and length are customizable, as is the connector, do note that a custom-designed antenna may be needed in those circumstances. Also tuning of the antenna may be needed in specific customer device environments. Taoglas offers this testing and tuning service subject to NRE and MOQ. Contact your regional Taoglas office for support.

The low power requirements of UWB mean increased battery life of sensors and tags leading to a reduction in overall operational costs. Taoglas has developed various innovative and new-to-market flexible embedded UWB antennas designed for seamless integration on plastics and using highly flexible micro-coaxial cable mounting while achieving high performance where space is limited. Taoglas UWB antennas have been designed for use with the recently launched Decawave ScenSor DW1000 module and are also compatible with any other UWB sensor modules on the market.

## 1.1 Return Loss

- **Radar** - These short-pulsed antennas provide very fine range resolution and precision distance and positioning measurement capabilities. UWB signals enable inexpensive high-definition radar antennas which find use in automotive sensors, smart airbags, and precision surveying applications amongst many others.
- **Home Network Connectivity** - Smart home and entertainment systems can take advantage of high data rates for streaming high-quality audio and video content in real-time for consumer electronics and computing within a home environment.
- **Position location & Tracking** - UWB antennas also find use in Position Location and Tracking applications such as locating patients in case of critical condition, hikers injured in remote areas, tracking cars, and managing a variety of goods in a big shopping mall. UWB offers better noise immunity and better accuracy within a few cm compared to current localization technologies such as Assisted GPS for Indoors, Wi-Fi, and cellular which are at best able to offer meter level precision. Tethered Indoor positioning UWB systems that measure the angles of arrival of ultra-wideband (UWB) radio signals perform triangulation by using multiple sensors to communicate with a tag device.

## 2. Specifications

Electrical			
Standard	US UWB channels 1-4	US UWB channels 5-9 EU UWB band	US UWB channels 10 - 15
Operation Frequency (GHz)	3.1 – 5.0	6.0 – 8.2	<b>8.2 – 10.3</b>
Return Loss (dB)	<- 10	<- 10	<- 10
Efficiency (%)	85	80	75
Peak Gain (dBi)	7.1	4.5	6.2
Max VSWR	2:1	2:1	2:1
Radiation Properties	omnidirectional		
Polarization	Linear		
Impedance ( $\Omega$ )	50		
Max Input Power	10		

Mechanical	
Height	0.24mm
Planner Dimension	34.9 x 24.5 mm
Cable	1.37 Coaxial, 100mm
Connector	I-PEX MHF <sup>®</sup> HT (U.FL Compatible)
Environmental	
Operation Temperature	-40° to 85°
Storage Temperature	-40°C to 85°C
Humidity	40% to 90%

\*Results obtained for antenna adhered to 2 mm thick ABS sheet.

### 3. Antenna Characteristics

#### 3.1 Return Loss

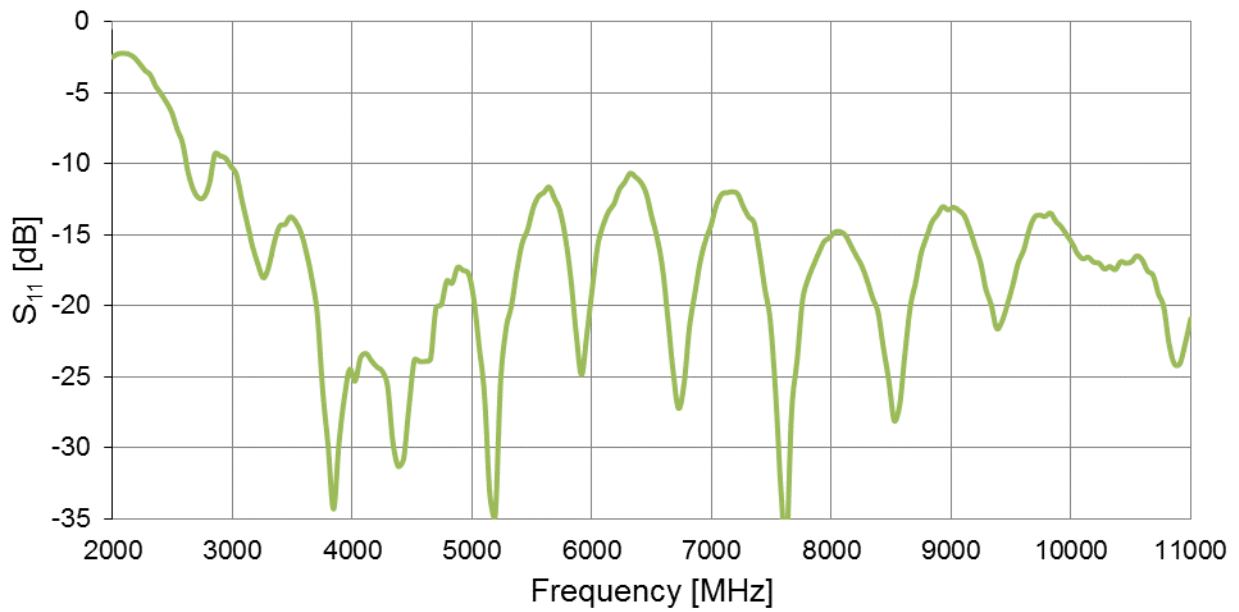

#### 3.2 VSWR

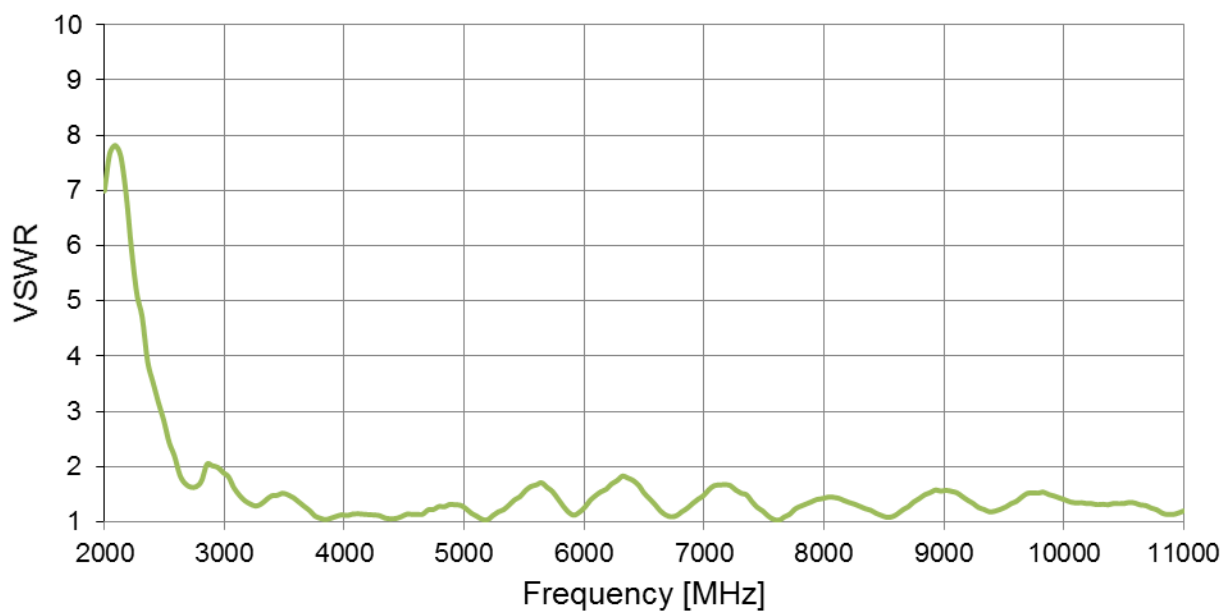

### 3.3 Efficiency

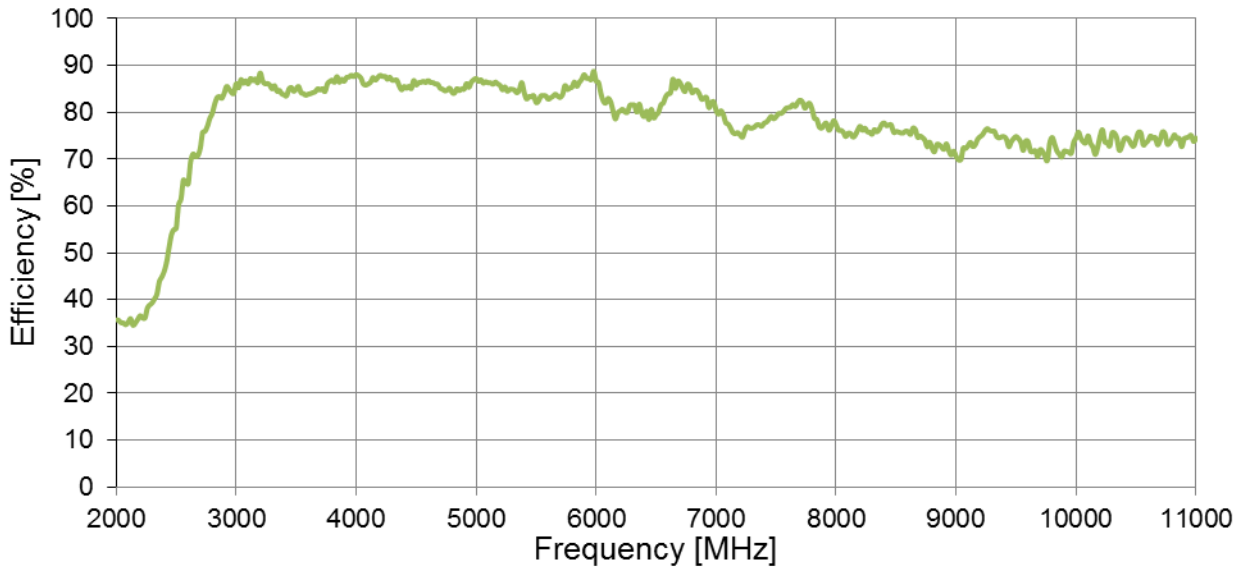

### 3.4 Peak Gain

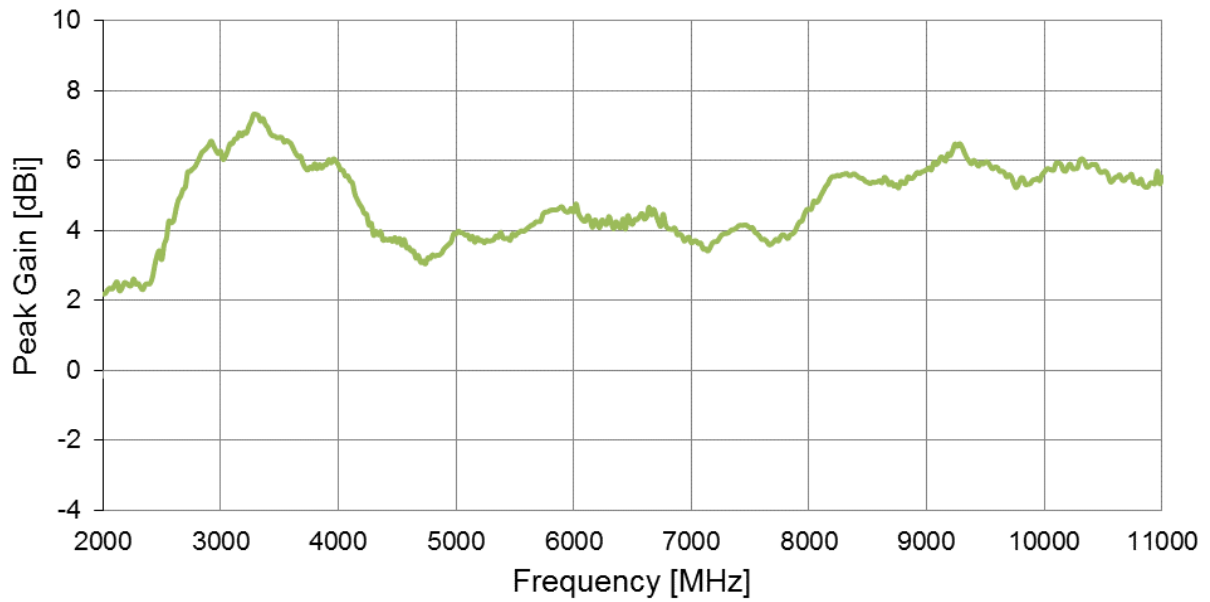

### 3.5 Average Gain

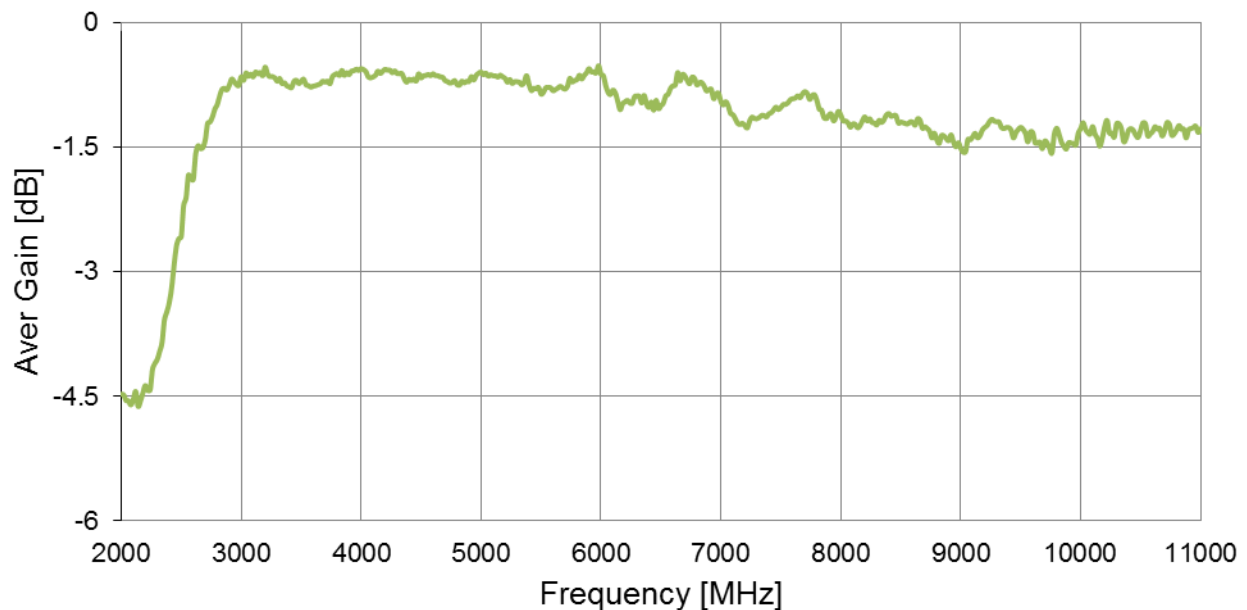

### 3.6 Group Delay (YZ Plane)

The Total System Group Delay (in seconds) is the total time delay or transmit time of the amplitude envelopes of the various sinusoidal components of UWB signals through a device or link budget system. Effectively it is the propagation delay in transmitting antenna (Tx), propagation channel (Ch), and in receiving antenna (Rx) summed together.

An even more important parameter is the Group Delay Variation from an average constant group delay. The group delay ripple is used to quantify this deviation. Ultimately, deviations from a maximally flat or constant group delay represent distortions in the output signal which is undesirable. A group delay variation of 100-150ps or less is considered acceptable for UWB system implementation.



### 3.7 Group Delay Vs Frequency

The group delay was obtained for two FXUWB10 antennas placed at a far-field distance of 0.5m. One of the antennas was kept stationary, while the other was rotated in 45° intervals.

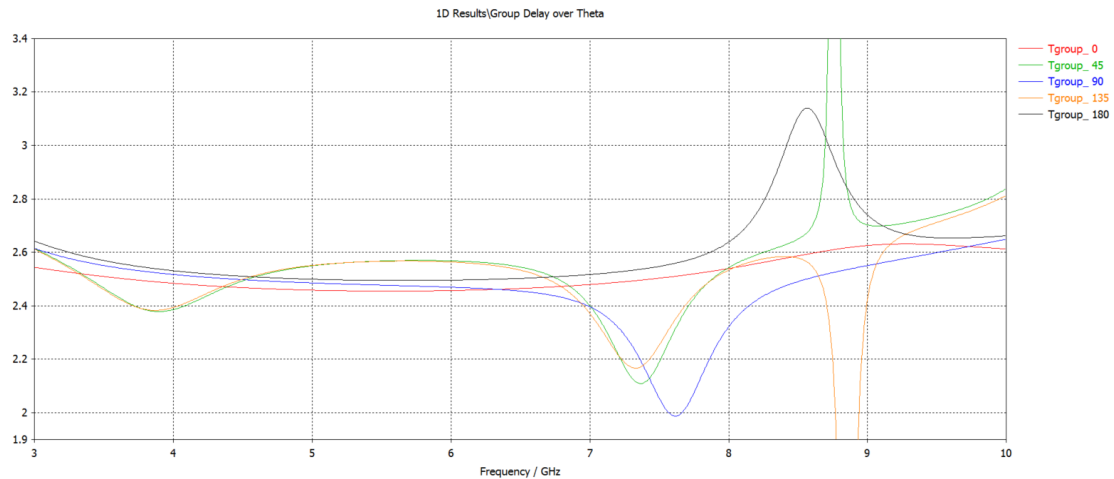

### 3.8 Group Delay Vs Theta

The values presented in the following graph for Group Delay vs Theta (azimuthal rotational angle) are obtained as peak-to-peak group delay values. The benchmark value for peak-to-peak Group delay over Theta is 150 ps, which is satisfied for all frequencies from 3GHz to 7GHz and 9GHz to 10GHz. The Group Delay is slightly increased from 7GHz to 8.7GHz, while for the 8.7GHz to 9GHz the antenna is not recommended for use.

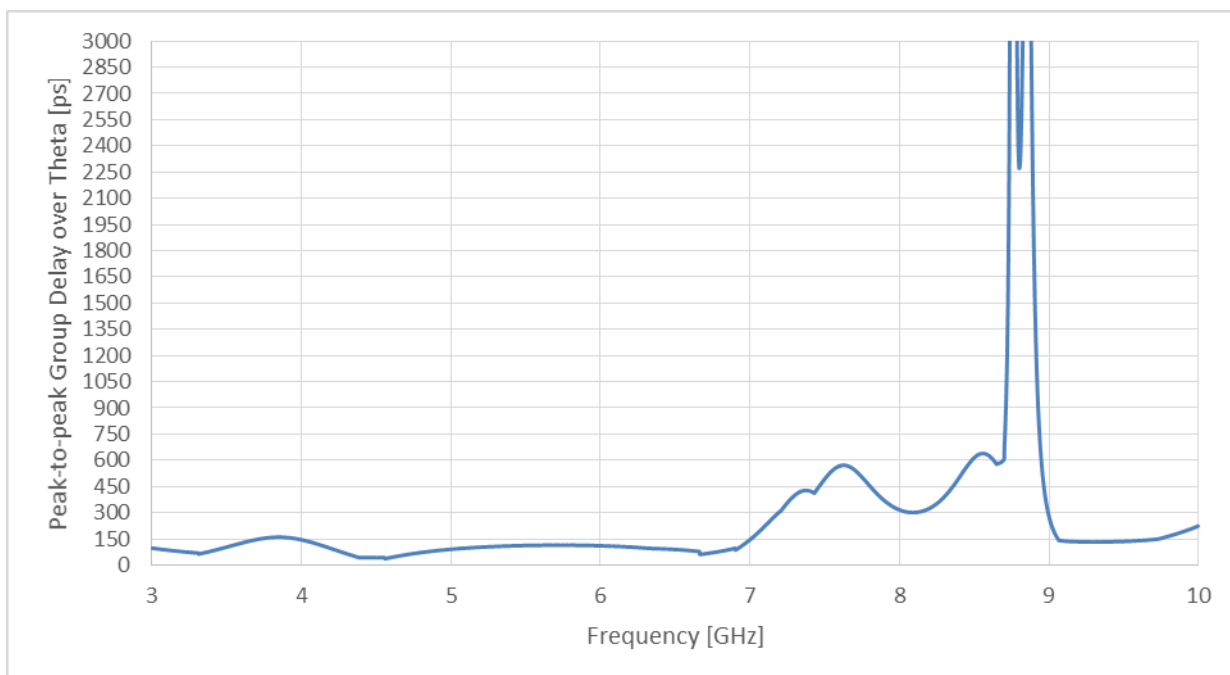

The measured Group Delay variation for the FXUBW10 antenna is presented in the graph above. This translates into maximum distance error introduced by antenna as presented below.

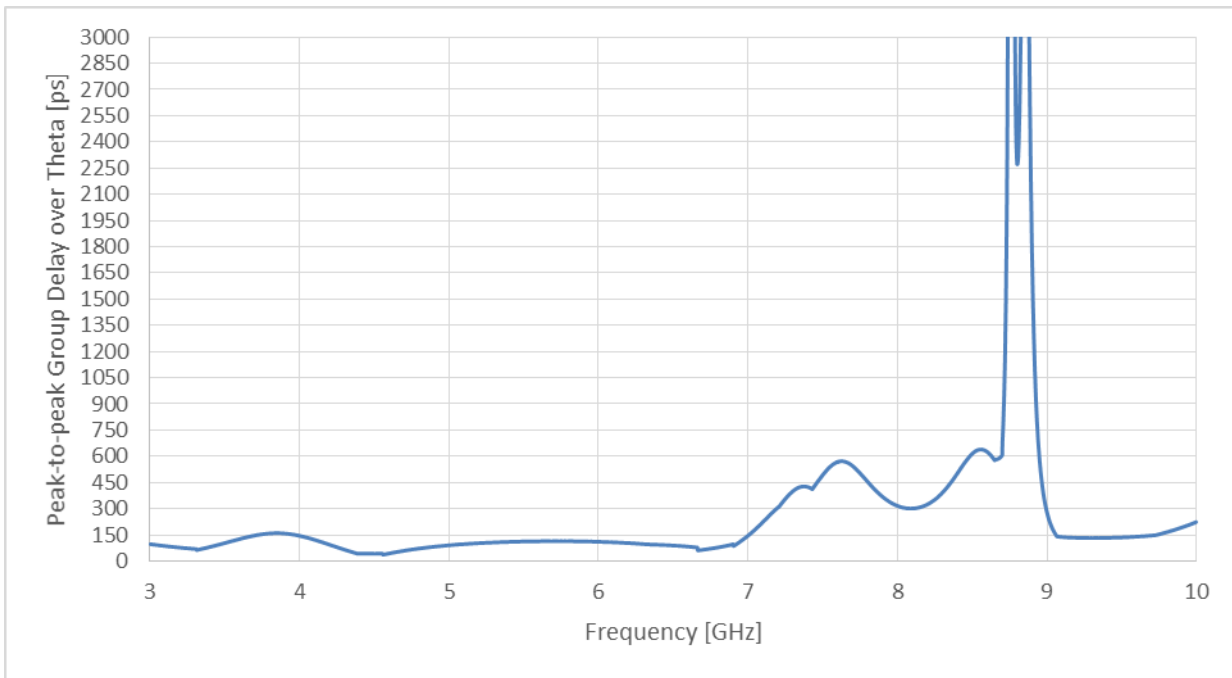

### 3.9 Fidelity

The impulse fidelity parameter is a measure of correlation between two impulses in the time domain  $r(t)$  and  $f(t)$ , most commonly the input and the output one of the antenna systems under study. Unlike other antenna parameters, impulse fidelity combines the antenna characterization in time, space, and frequency in one parameter.

The pulse fidelity is defined in as:

$$F = \max_{\tau} \int_{-\infty}^{\infty} \frac{f(t)}{[\int_{-\infty}^{\infty} |f(t)|^2 dt]^{1/2}} \cdot \frac{r(t+\tau)}{[\int_{-\infty}^{\infty} |r(t)|^2 dt]^{1/2}} dt$$

The maximum fidelity, therefore minimum distortion between the two signals, is obtained for  $\tau$  such that the integral term is maximized, which is simply the cross-correlation of the two normalized signals  $f(t)$  and  $r(t)$ . The maximum fidelity, in this case, is equal to 1 or 100%. The desired impulse fidelity for UWB antennas is over 0.9 or 90% as stipulated in the FCC Part 15 of the Commission's Rules Regarding Ultra-Wideband Transmission Systems (FCC 02-48).

Below is an example of the input signal and signal received in one particular direction from the antenna.

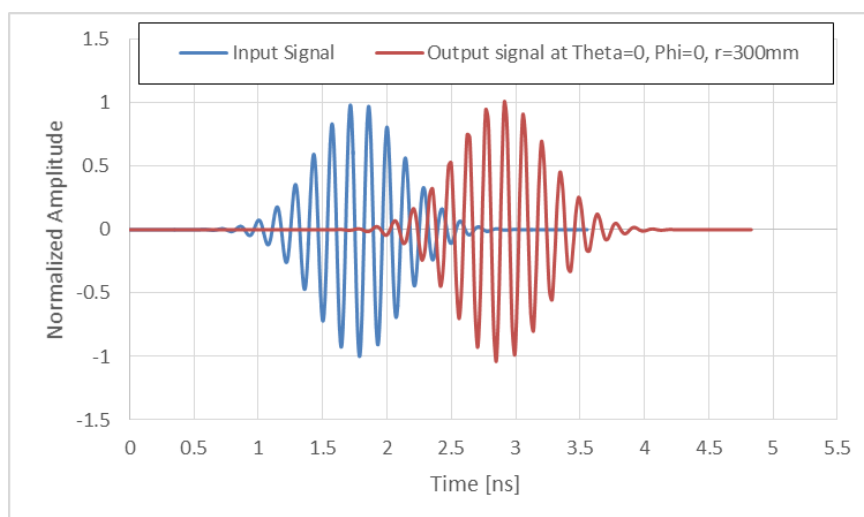

Fidelity of signals as above is calculated and results as below are obtained. The values are well above 0.9 and it is considered that antenna has very good performance.

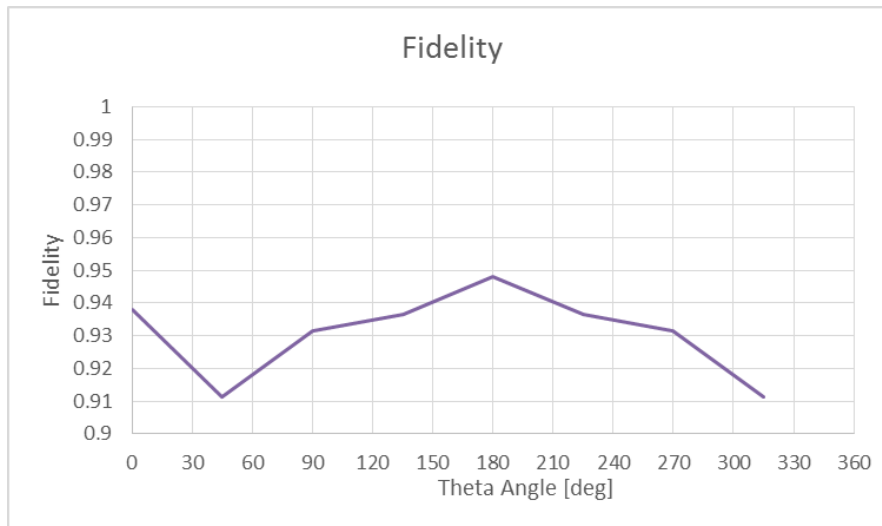

## 4. Radiation Patterns

### 4.1 Test Setup

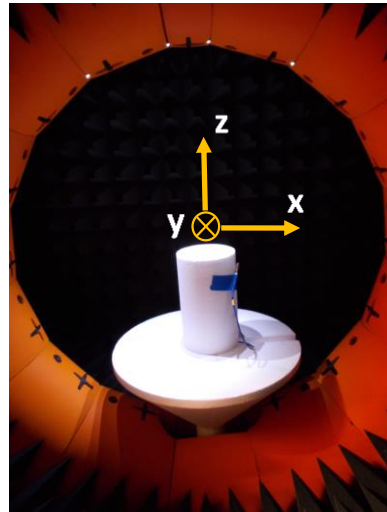
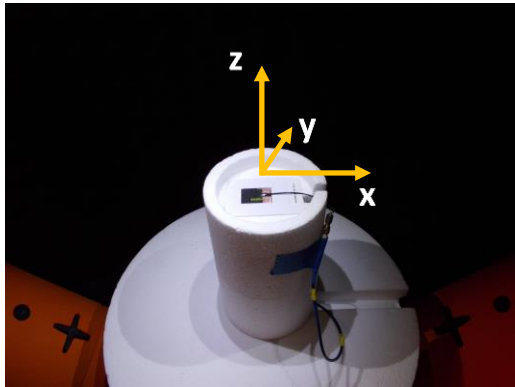

⊗ Direction into the image

4.2 3GHz 3D and 2D Radiation Patterns

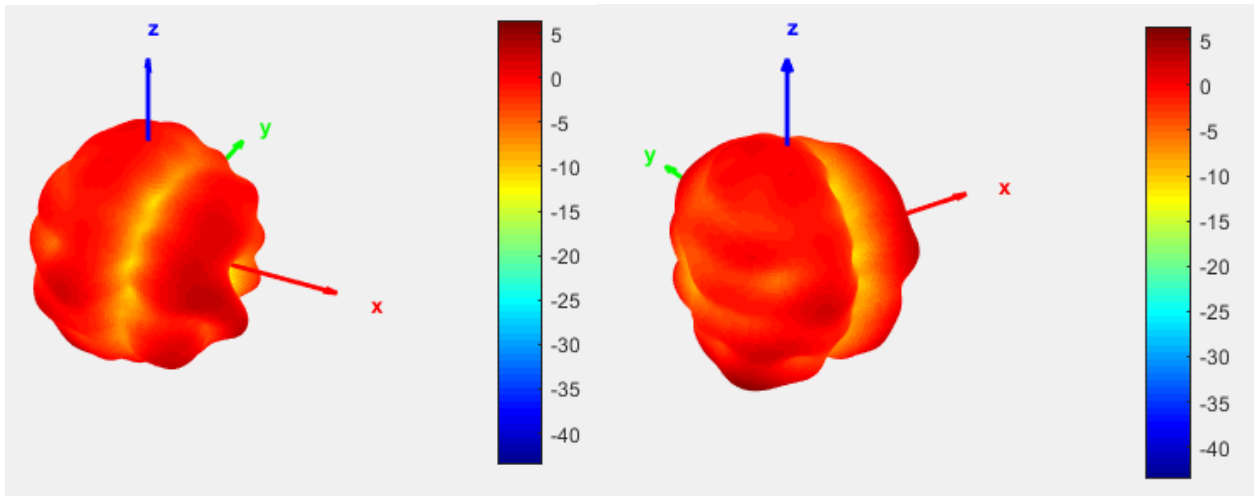

XY Plane XZ Plane YZ Plane

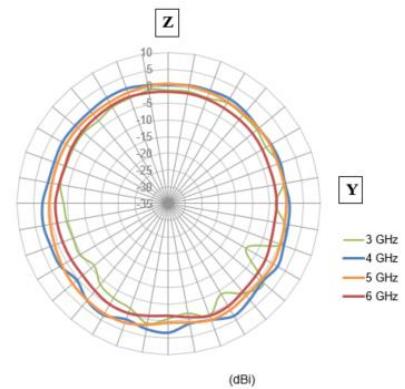
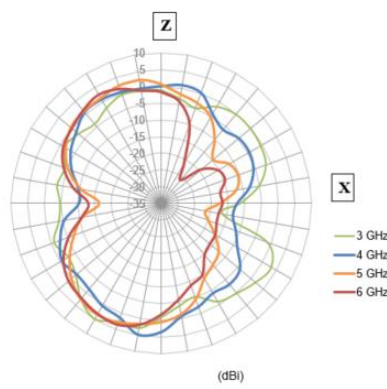
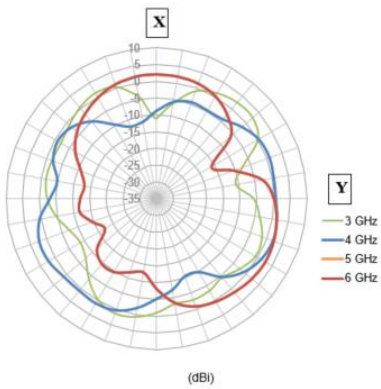

### 4.3 9GHz 3D and 2D Radiation Patterns

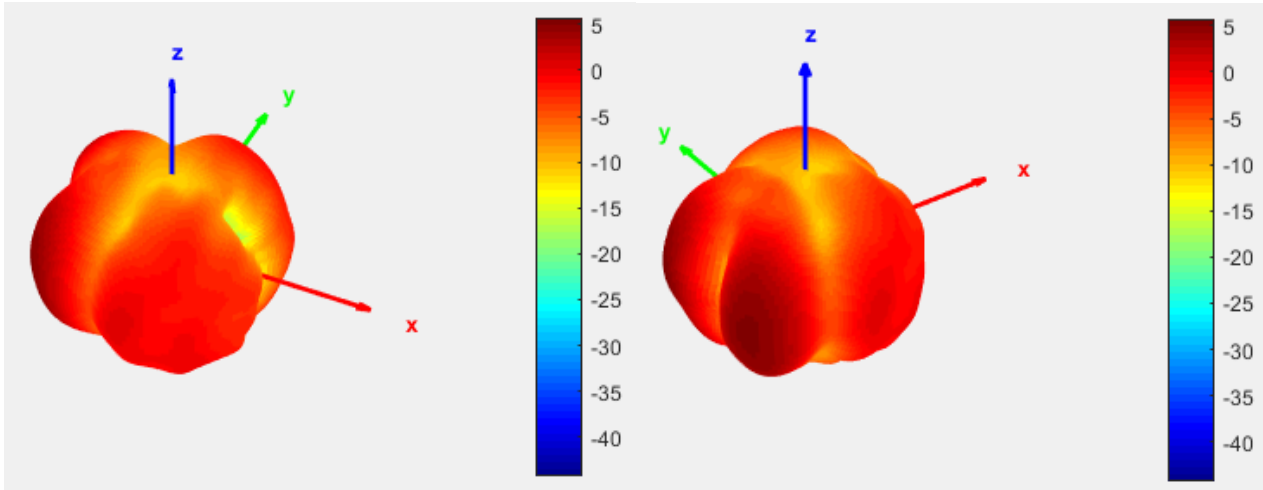

XY Plane

XZ Plane

YZ Plane

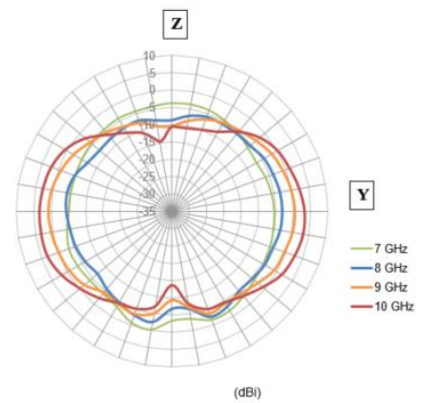
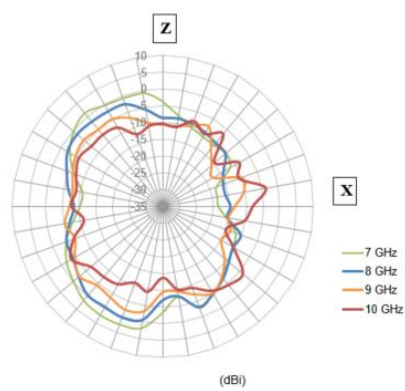
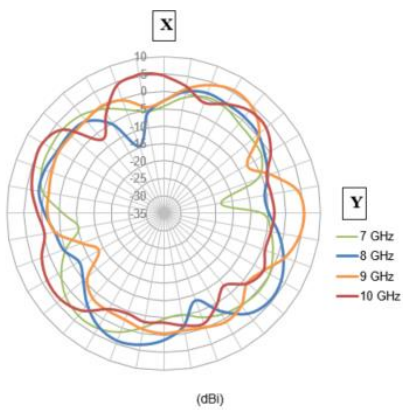

# 5. Mechanical Drawing (Units: mm)

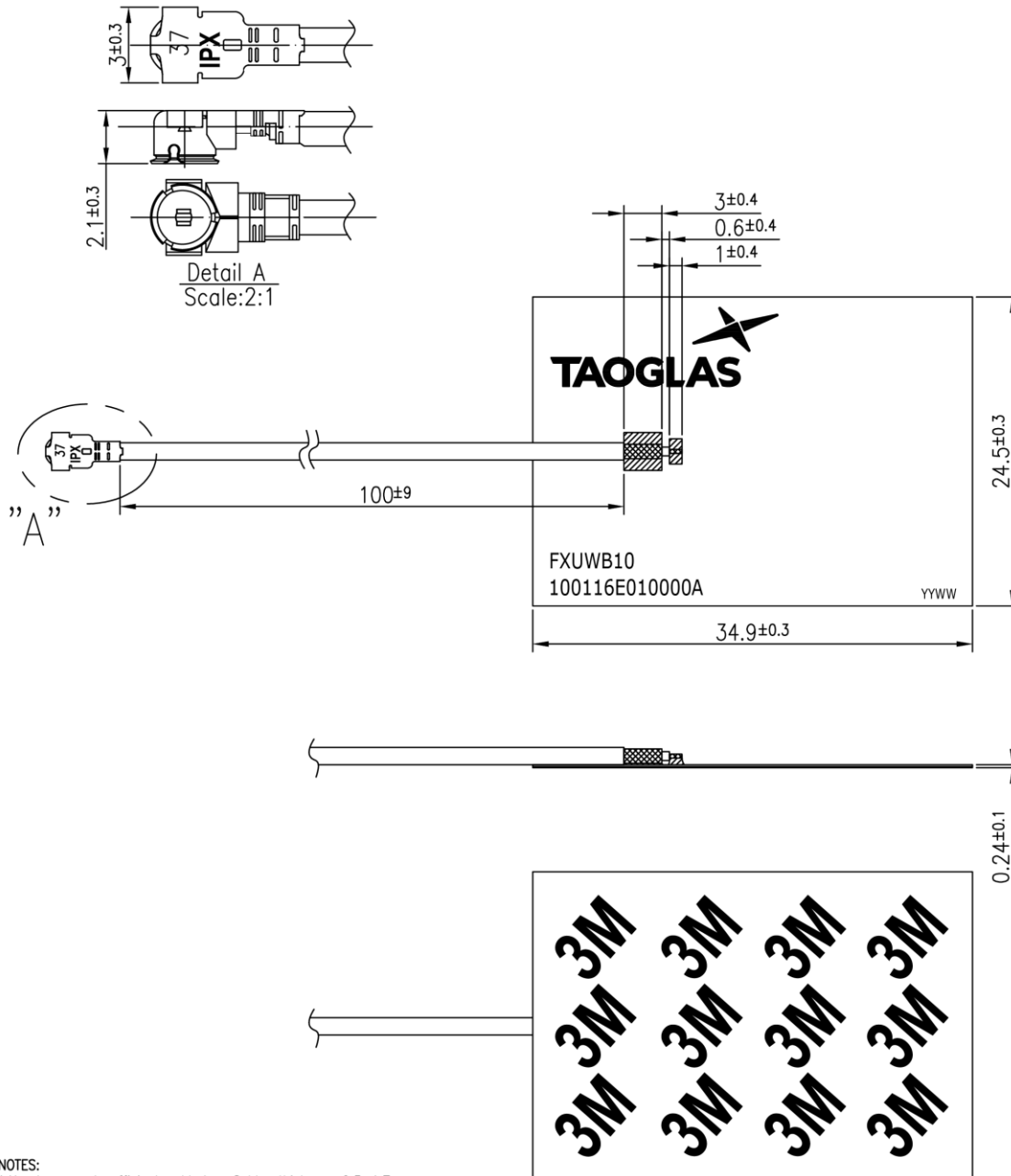

- NOTES:
- 1.No dregs or insufficient soldering. Solder thickness 0.3~1.7mm
  - 2.The solder must be smooth and full to the edges of the pad.  
The solder must not extend outside of the pad area.
  - 3.The connector position has special orientation to the PCB as per drawing.
  - 4.All material must be RoHS compliant.
  - 5.Open/short QC, VSWR required.
  - 6.Soldered area. 

	Name	P/N	Material	Finish	QTY
1	FXUWB10 FPCB	100116E010000A	Polymer	Black	1
2	1.37 Coaxial Cable	300515C010000A	FEP	Black	1
3	IPEX MHFHT	204511G000000A	Brass	Au Plated	1
4	Double-Sided Adhesive	100116E010000A	3M 467	Brown Liner	1



## 6. Packaging

50pcs FXUWB10.07.0100C per PE Bag  
 Bag Dimensions - 220 x 100mm  
 Weight - 180g

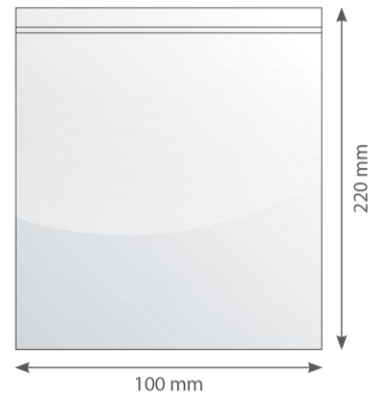

1000pcs FXUWB10.07.0100C per carton  
 Carton - 330 x 280 x 270mm  
 Weight - 3.65Kg

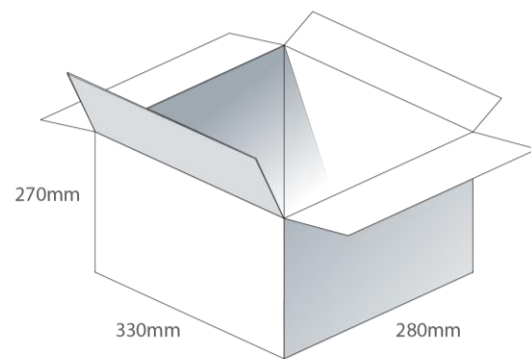

## 7. Application Note – Cable Routing

Cable routing is tested for this antenna, as seen below, for four possible cable routing scenarios. S<sub>11</sub> shows only slight influence on the resonance in the low band (3-5 GHz) which will not influence the antenna performance negatively as the values are always below -10 dB.

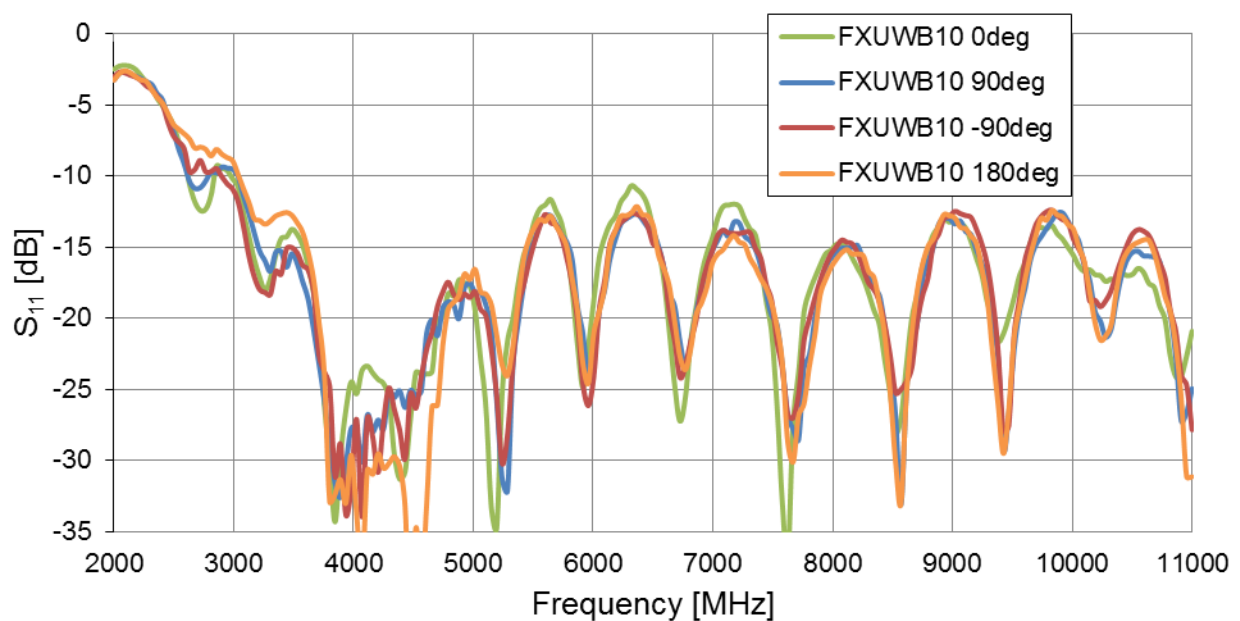
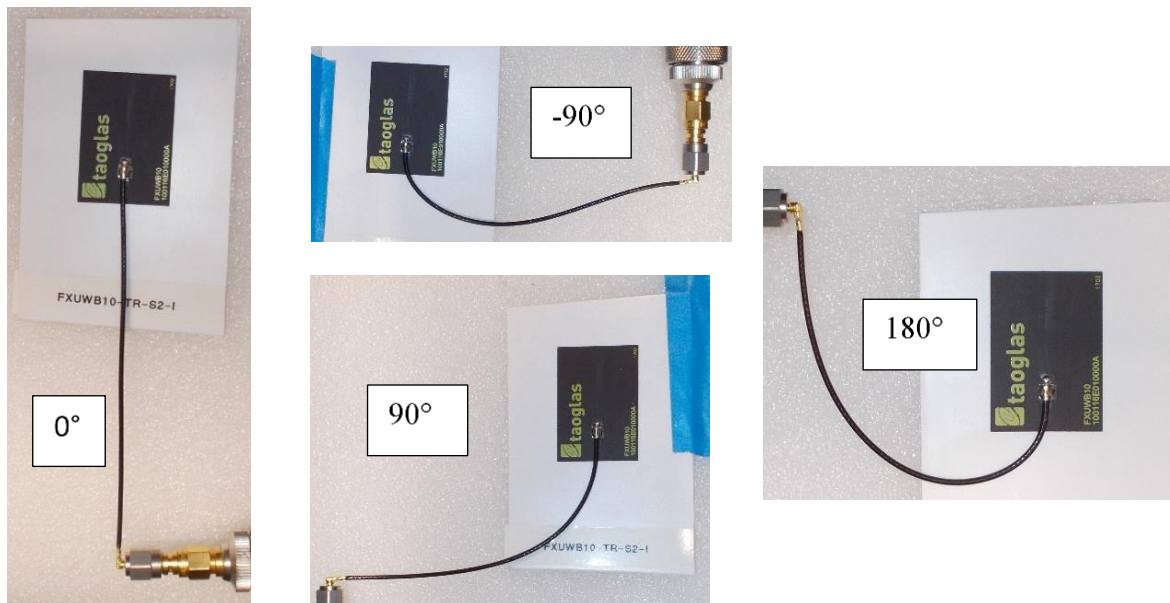

Changelog for the datasheet

**SPE-17-8-052 - FXUWB10.07.0100C**

**Revision: C (Current Version)**

Date:	2022-02-18
Changes:	Updated datasheet Template Updated Drawings
Changes Made by:	Paul Doyle

**Previous Revisions**

**Revision: B**

Date:	2017-08-17
Changes:	Dimensions Updated
Changes Made by:	Sean Hancox

**Revision: A (Original First Release)**

Date:	2017-06-10
Notes:	
Author:	Jack Conroy

---

**Previous Revisions (Continued)**



**TAOGLAS**®

[www.taoglas.com](http://www.taoglas.com)

