

Solderless terminals

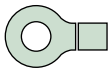

**RING TONGUE (R type)** Vinyl-insulated with copper sleeve

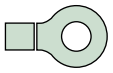

The terminal barrel is first covered with a copper sleeve and then insulated with vinyl; it is extremely resistant to vibration.

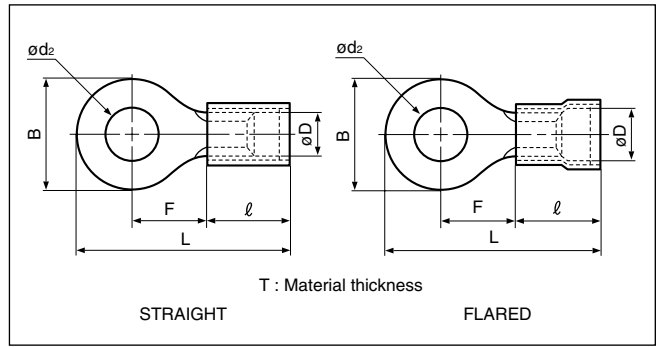

Certificate No.:

Applicable Wire AWG#(mm <sup>2</sup> )	Stud size		Part No.		Standard	Dimensions mm (in.)										Color	Tool No.	Qty/box		
	American	Metric	Straight	Flared		$\phi d_2$	B	L	F	$\ell$	$\phi D$		T							
26 to 22 (0.2 to 0.5)	1-2	2	VD0.5-2	-		2.2 (.087)	5.2 (.205)	16.4 (.646)	5.8 (.228)	8.0 (.315)	2.2 (.087)	2.5 (.098)	0.5 (.020)	Yellow	YNT-2622 YA-1 YA-2 BCT-0514	1,000				
	3-4	3	VD0.5-3	-		3.2 (.126)	5.2 (.205)	16.4 (.646)	5.8 (.228)											
	5-6	3.5	VD0.5-3.7	-		3.7 (.146)	6.6 (.260)	19.0 (.748)	7.7 (.303)											
	8	4	VD0.5-4	-		4.3 (.169)	6.6 (.260)	19.0 (.748)	7.7 (.303)											
	10	5	VD0.5-5	-		5.3 (.209)	8.0 (.315)	19.0 (.748)	7.0 (.276)											
	1-2	2	-	FVD0.5-2			2.2 (.087)	5.2 (.205)	16.7 (.657)	5.8 (.228)	8.3 (.327)	2.2 (.087)	2.5 (.098)				0.5 (.020)	Yellow	YNT-2622 YA-1 YA-2 BCT-0514	1,000
	3-4	3	-	FVD0.5-3			3.2 (.126)	5.2 (.205)	16.7 (.657)	5.8 (.228)										
	5-6	3.5	-	FVD0.5-3.7			3.7 (.146)	6.6 (.260)	19.3 (.760)	7.7 (.303)										
	8	4	-	FVD0.5-4			4.3 (.169)	6.6 (.260)	19.3 (.760)	7.7 (.303)										
	10	5	-	FVD0.5-5			5.3 (.209)	8.0 (.315)	19.3 (.760)	7.0 (.276)										
22 to 16 (0.25 to 1.65)	1-2	2	VD1.25-2	FVD1.25-2			2.2 (.087)	5.5 (.217)	16.3 (.642)	4.0 (.157)	9.6 (.378)	3.5 (.138)	4.0 (.157)	0.8 (.031)	Red	YNT-2216 YA-1 YA-2 YA-4 BCT-0514	1,000			
	3-4	3	VD1.25-3	FVD1.25-3			3.2 (.126)	5.5 (.217)	16.3 (.642)	4.0 (.157)										
	3-4	3	VD1.25-MS3	FVD1.25-MS3			3.2 (.126)	5.5 (.217)	18.0 (.709)	5.6 (.220)										
	3-4	3	VD1.25-L3	FVD1.25-L3			3.2 (.126)	8.0 (.315)	20.6 (.811)	7.0 (.276)										
	5-6	3.5	VD1.25-3.7	FVD1.25-3.7			3.7 (.146)	5.5 (.217)	16.3 (.642)	4.0 (.157)										
	5-6	3.5	VD1.25-M3	FVD1.25-M3		3.7 (.146)	6.6 (.260)	19.2 (.756)	6.3 (.248)											
	8	4	VD1.25-M4	FVD1.25-M4		4.3 (.169)	6.6 (.260)	19.2 (.756)	6.3 (.248)											
	8	4	VD1.25-4	FVD1.25-4		4.3 (.169)	8.0 (.315)	20.6 (.811)	7.0 (.276)											
	10	5	VD1.25-5	FVD1.25-5		5.3 (.209)	8.0 (.315)	20.6 (.811)	7.0 (.276)											
	1/4	6	VD1.25-6	FVD1.25-6		6.4 (.252)	11.6 (.457)	26.5(1.043)	11.1 (.437)											
5/16	8	VD1.25-8	FVD1.25-8	8.4 (.331)	11.6 (.457)	26.5(1.043)	11.1 (.437)													
3/8	10	VD1.25-10	FVD1.25-10	10.5 (.413)	13.6 (.535)	30.3(1.193)	13.9 (.547)													
16 to 14 (1.04 to 2.63)	1-2	2	VD2-S2	FVD2-S2		2.2 (.087)	6.4 (.252)	17.1 (.673)	4.3 (.169)	9.6 (.378)	4.1 (.161)	4.7 (.185)	0.8 (.031)	Blue	YNT-1614 YA-1 YA-2 YA-4 BCT-0514	1,000				
	3-4	3	VD2-MS3	FVD2-MS3		3.2 (.126)	5.5 (.217)	18.0 (.709)	5.6 (.220)											
	3-4	3	VD2-S3.3	FVD2-S3.3		3.2 (.126)	6.4 (.252)	17.1 (.673)	4.3 (.169)											
	3-4	3	VD2-3	FVD2-3		3.2 (.126)	8.5 (.335)	21.6 (.850)	7.8 (.307)											
	5-6	3.5	VD2-S3	FVD2-S3		3.7 (.146)	6.4 (.252)	17.1 (.673)	4.3 (.169)											
	5-6	3.5	VD2-M3	FVD2-M3		3.7 (.146)	6.6 (.260)	19.2 (.756)	6.3 (.248)											
	5-6	3.5	VD2-P3.5	FVD2-P3.5		3.7 (.146)	7.0 (.276)	20.8 (.819)	7.7 (.303)											
	8	4	VD2-M4	FVD2-M4		4.3 (.169)	6.6 (.260)	19.2 (.756)	6.3 (.248)											
	8	4	VD2-P4	FVD2-P4		4.3 (.169)	7.0 (.276)	20.8 (.819)	7.7 (.303)											
	8	4	VD2-4	FVD2-4		4.3 (.169)	8.5 (.335)	21.6 (.850)	7.8 (.307)											
	10	5	VD2-M5	FVD2-M5		5.3 (.209)	8.5 (.335)	21.6 (.850)	7.8 (.307)											
	10	5	VD2-5	FVD2-5		5.3 (.209)	9.5 (.374)	21.6 (.850)	7.3 (.287)											
	1/4	6	VD2-6	FVD2-6		6.4 (.252)	12.0 (.472)	26.6(1.047)	11.0 (.433)											
	5/16	8	VD2-8	FVD2-8		8.4 (.331)	12.0 (.472)	26.6(1.047)	11.0 (.433)											
	3/8	10	VD2-10	FVD2-10		10.5 (.413)	13.6 (.535)	30.3(1.193)	13.9 (.547)											
	1/2	12	VD2-12	FVD2-12		13.0 (.512)	19.0 (.748)	35.8(1.409)	16.7 (.657)											
1/2	14	VD2-14	FVD2-14	15.0 (.591)	27.0(1.063)	44.3(1.744)	21.2 (.835)													
5/8	16	VD2-16	FVD2-16	17.0 (.669)	27.0(1.063)	44.3(1.744)	21.2 (.835)													
3/4	20	VD2-20	FVD2-20	21.0 (.827)	27.0(1.063)	44.3(1.744)	21.2 (.835)													
12 to 10 (2.63 to 6.64)	3-4	3	VD5.5-3	FVD5.5-3		3.2 (.126)	9.5 (.374)	27.0(1.063)	8.3 (.327)	14.0 (.551)	5.7 (.224)	6.5 (.256)	1.0 (.039)	Yellow	YNT-1210S YA-4 BCT-0514	500				
	5-6	3.5	VD5.5-S3	FVD5.5-S3		3.7 (.146)	7.2 (.283)	23.5 (.925)	5.9 (.232)											
	8	4	VD5.5-S4	FVD5.5-S4		4.3 (.169)	7.2 (.283)	23.5 (.925)	5.9 (.232)											
	8	4	VD5.5-4	FVD5.5-4		4.3 (.169)	9.5 (.374)	27.0(1.063)	8.3 (.327)											
	10	5	VD5.5-5	FVD5.5-5		5.3 (.209)	9.5 (.374)	27.0(1.063)	8.3 (.327)											
	10	5	VD5.5-S5	FVD5.5-S5		5.3 (.209)	13.2 (.520)	29.6(1.165)	9.0 (.354)											
	1/4	6	VD5.5-6	FVD5.5-6		6.4 (.252)	12.0 (.472)	33.0(1.299)	13.0 (.512)											
	1/4	6	VD5.5-S6	FVD5.5-S6		6.4 (.252)	13.2 (.520)	29.6(1.165)	9.0 (.354)											
	5/16	8	VD5.5-S8	FVD5.5-S8		8.4 (.331)	13.2 (.520)	29.6(1.165)	9.0 (.354)											
	5/16	8	VD5.5-8	FVD5.5-8		8.4 (.331)	15.0 (.591)	35.2(1.386)	13.7 (.539)											
	3/8	10	VD5.5-10	FVD5.5-10		10.5 (.413)	15.0 (.591)	35.2(1.386)	13.7 (.539)											
	1/2	12	VD5.5-12	FVD5.5-12		13.0 (.512)	19.2 (.756)	39.6(1.559)	16.0 (.630)											
	1/2	14	VD5.5-14	FVD5.5-14		15.0 (.591)	32.0(1.260)	55.3(2.177)	25.3 (.996)											
	5/8	16	VD5.5-16	FVD5.5-16		17.0 (.669)	32.0(1.260)	55.3(2.177)	25.3 (.996)											
	11/16	18	VD5.5-18	FVD5.5-18		19.0 (.748)	32.0(1.260)	55.3(2.177)	25.3 (.996)											
	3/4	20	VD5.5-20	FVD5.5-20		21.0 (.827)	32.0(1.260)	55.3(2.177)	25.3 (.996)											

Note: 1) The part numbers indicated in the above table are for products with a brazed seam.  
 When ordering products with a butted seam, add the prefix "WS" to the part number (ex. VD2-4 → **VDWS2-4**).  
 2) To order products with nylon insulation, change the "V" in the part number prefix to "N" (ex. FVD2-4 → **FND2-4**).  
 Because nylon absorbs moisture, care must be taken concerning storage.  
 3) Delivery lead times may vary depending on the product. Contact JST for details.

Solderless terminals

**RING TONGUE (R type) Vinyl-insulated with copper sleeve (Medium size)**

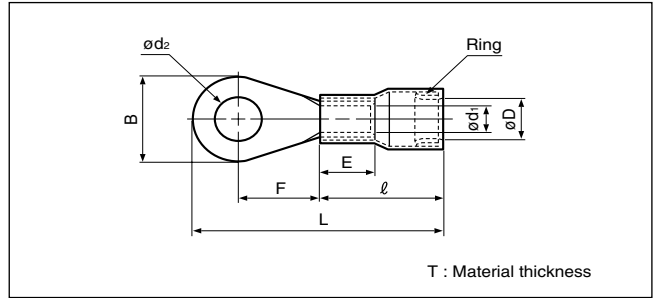
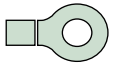
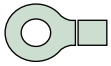

Certificate No.: E42024 LR20812

Applicable Wire AWG#(mm <sup>2</sup> )	Stud size		Part No.	Standard	Dimensions mm (in.)										Color	Tool No.	Qty/box
	American	Metric			$\phi d_2$	B	L	F	E	$\ell$	$d_1$	$\phi D$ (min.)	T				
8 (6.64 to 10.52)	10	5	FVD8-5		5.3 (.209)	10.3 (.406)	36.3(1.429)	10.6 (.417)	8.3 (.327)	19.2 (.756)	4.6 (.181)	7.5 (.295)	1.1 (.043)	Red	YF-1   YNE-38 E-4	200	
	1/4	6	FVD8-6		6.4 (.252)	11.6 (.457)	36.3(1.429)	11.3 (.445)									
	5/16	8	FVD8-8		8.4 (.331)	14.4 (.567)	38.8(1.528)	12.4 (.488)									
	3/8	10	FVD8-10		10.5 (.413)	14.4 (.567)	38.8(1.528)	12.4 (.488)									
6 (10.52 to 16.78)	10	5	FVD14-5		5.3 (.209)	12.2 (.480)	39.2(1.543)	13.1 (.516)	10.9 (.429)	20.0 (.787)	5.7 (.224)	10.5 (.413)	1.1 (.043)	Blue	YF-1   YNE-38 E-4	100	
	1/4	6	FVD14-6		6.4 (.252)	12.2 (.480)	39.2(1.543)	13.1 (.516)									
	5/16	8	FVD14-8		8.4 (.331)	15.3 (.602)	42.4(1.669)	14.7 (.579)									
	3/8	10	FVD14-10		10.5 (.413)	15.3 (.602)	42.4(1.669)	14.7 (.579)									
4 (16.78 to 26.66)	1/4	6	FVD22-6		6.4 (.252)	13.8 (.543)	44.0(1.732)	14.1 (.555)	12.0 (.472)	23.0 (.906)	7.2 (.284)	11.5 (.453)	1.3 (.051)	Yellow	YF-1   YNE-38 E-4	100	
	5/16	8	FVD22-8		8.4 (.331)	15.9 (.626)	46.1(1.815)	15.1 (.594)									
	3/8	10	FVD22-10		10.5 (.413)	15.9 (.626)	46.1(1.815)	15.1 (.594)									
2 (26.66 to 42.42)	1/4	6	FVD38-6		6.4 (.252)	17.5 (.689)	51.1(2.012)	17.3 (.681)	13.5 (.531)	25.0 (.984)	9.1 (.358)	13.3 (.524)	1.4 (.055)	Red	YF-1   YNE-38 E-4	100	
	5/16	8	FVD38-8		8.4 (.331)	17.5 (.689)	51.1(2.012)	17.3 (.681)									
	3/8	10	FVD38-10		10.5 (.413)	17.5 (.689)	51.1(2.012)	17.3 (.681)									
	1/2	12	FVD38-12		13.0 (.512)	19.9 (.784)	55.4(2.181)	20.4 (.803)									

Note:1) Delivery lead times may vary depending on the product. Contact JST for details.

Solderless terminals

**RING TONGUE (R type) Non-insulated (Heavy duty)**

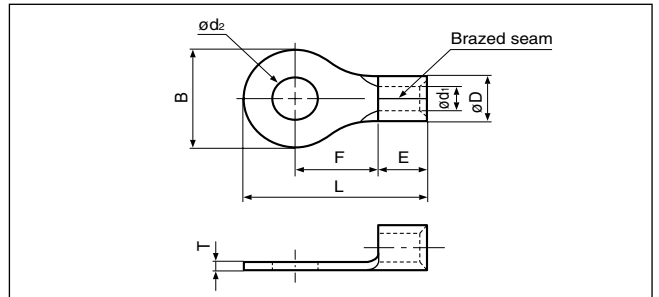
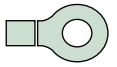
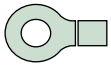

	Applicable Wire AWG#(mm <sup>2</sup> )	Stud size		Part No.	Standard	Dimensions mm (in.)										Tool No.	Qty/box			
		American	Metric			$\phi d_2$	B	L	F	E	$\phi D$	$\phi d_1$	T							
E type	22 to 16 (0.25 to 1.65)	5-6	3.5	1.25-3E		3.7 (.146)	8.0 (.315)	16.4 (.646)	7.6 (.299)	4.8 (.189)	4.0 (.157)	1.9 (.075)	1.0 (.039)	YHT-2210 YA-1, YA-2 YA-4 BCT-0514	1,000					
		8	4	1.25-4E		4.3 (.169)	8.0 (.315)	16.4 (.646)	7.6 (.299)											
		10	5	1.25-5E		5.3 (.209)	8.0 (.315)	16.4 (.646)	7.6 (.299)											
	16 to 14 (1.04 to 2.63)	8	4	2-4E		4.3 (.169)	9.2 (.362)	18.6 (.732)	7.2 (.284)						6.8 (.268)	5.5 (.217)	2.3 (.091)	1.6 (.063)	YHT-2210 YA-1 YA-2 YA-4 BCT-0514	1,000
		10	5	2-5E		5.3 (.209)	9.2 (.362)	18.6 (.732)	7.2 (.284)											
		1/4	6	2-6E		6.4 (.252)	13.6 (.535)	25.3 (.996)	11.7 (.461)											
		5/16	8	2-8E		8.4 (.331)	13.6 (.535)	25.3 (.996)	11.7 (.461)											
ES type	16 to 14 (1.04 to 2.63)	3/8	10	2-10E	10.5 (.413)	13.6 (.535)	25.3 (.996)	11.7 (.461)	6.2 (.244)	5.5 (.217)	3.0 (.118)	1.2 (.047)	—	1,000						
		1/2	12	2-12E	13.0 (.512)	19.0 (.748)	33.0(1.299)	16.7 (.657)												
		3-4	3	2-3.2ES	3.2 (.126)	7.1 (.280)	15.4 (.606)	5.7 (.224)												
		5-6	3.5	2-3ES	3.7 (.146)	7.1 (.280)	15.4 (.606)	5.7 (.224)												
		8	4	2-4ES	4.3 (.169)	8.7 (.343)	17.8 (.701)	7.3 (.287)												
		10	5	2-5ES	5.3 (.209)	8.7 (.343)	17.8 (.701)	7.3 (.287)												
		1/4	6	2-6ES	6.4 (.252)	13.5 (.532)	24.2 (.953)	11.3 (.445)												
		5/16	8	2-8ES	8.4 (.331)	13.5 (.532)	24.2 (.953)	11.3 (.445)												
3/8	9	2-9ES	9.8 (.386)	13.5 (.532)	24.2 (.953)	11.3 (.445)														
3/8	10	2-10ES	10.5 (.413)	13.5 (.532)	24.2 (.953)	11.3 (.445)														
3/8	10	2-L10ES	10.5 (.413)	19.0 (.748)	31.6(1.244)	16.0 (.630)														

Note:1) The  $\phi D$  of products with the suffix "E" at the end of the part number is one size larger than the non-insulated terminal with the same part number.

- For the crimping tool jaws, select one size larger from among the three jaw sizes on the YHT-2210 crimping tool.
- Contact JST concerning minimum lot size.
- The part numbers indicated in the above table are for products with a brazed seam. When ordering products with a butted seam, add the prefix "WS" to the part number (ex. 2-4E → WS2-4E).
- Delivery lead times may vary depending on the product. Contact JST for details.