



## Terminal Products and Tools

<b>Terminals</b>	
Overview .....	K2-K5
Nylon Insulated Ring .....	K6-K10
Vinyl Insulated Ring .....	K11-K12, K18
Non-Insulated Ring .....	K13-K15
Heavy Duty Ring .....	K16
High Temperature Non-Insulated .....	K17
TEFZEL® Insulated Ring .....	K19
Rectangular Rings .....	K20-K21
<b>Flag Terminals</b> .....	K22
<b>Fork Terminals</b>	
Nylon Insulated Fork .....	K23-K24
Vinyl Insulated Fork .....	K25
Non-Insulated Fork .....	K26
<b>Locking Fork Terminals</b>	
Nylon Insulated Fork .....	K27
Vinyl Insulated Fork .....	K28
Heat Shrinkable Fork .....	K29
Non-Insulated Fork .....	K29
<b>Pin Terminals</b> .....	K30
<b>Insulated Ferrules</b> .....	K31-K32
<b>Non-Insulated Ferrules</b> .....	K33
<b>Heat Shrinkable Terminals, Splices, Disconnects</b> .....	K34-K35
<b>Splice Connectors</b> .....	K36-K38
<b>Disconnects</b>	
Female (250 Series) .....	K39-K40
Piggy Back (250 Series) .....	K40
Female (187 Series) .....	K41
Male (250 Series) .....	K42
Male (187 Series and 110 Series) .....	K43
250 Series Adapters and Coupler .....	K44
Wristlock Disconnects .....	K44
<b>Pin Terminals/Vinyl Terminals (Mini-Pack)</b> .....	K45
<b>Wire Joints – Nylon Insulated</b> .....	K46
<b>Installation Kits</b> .....	K47
<b>Application Tools</b>	
Plier Tools .....	K48-K49
Comfort Crimp .....	K-50-K51
Ratchet Hand Tools .....	K52-K55
Toggle Type .....	K55-K56
Flag Type .....	K55
TBM60RS Short Handle .....	K56
Shure-Stake® Auto Feed .....	K57
ERG 3000 .....	K58
Air Operated .....	K59-K60
Air Hydraulic .....	K60
Twelve Ton Crimping .....	K61
Installation Dies .....	K61-62
Electric Hydraulic Pump .....	K63
Tool Charts .....	K64-K65
<b>Stud Size and Clearance Hole Chart</b> .....	K65
<b>Wire Guide Tables</b> .....	K66-K69
<b>Military Cross Reference</b> .....	K70
<b>Cross Reference for Packaging</b> .....	K71-K74

### Why Sta-Kon® Terminals Are Better

Thomas & Betts developed the first tool-applied solderless terminals and connectors over 60 years ago in response to industry awareness of the need for better performance of electrical systems.

#### Chamfered/Funneled Terminal Barrel Entry

This feature makes wire insertion faster and easier. Chamfering eliminates wire strand “hang up” and departure upon insertion into the terminal’s barrel. The loss of even a couple of wire strands can have negative results on electrical efficiency and resistance to mechanical strain.

are your goals, then you must design a terminal with a long barrel. Most competitive barrel lengths range from 20%-50% shorter than Sta-Kon® terminals. The results are usually a stream of electrical failure, rework and added expense. This also provides the insulator with additional surface area, holding tight to the barrel. Many competitive insulators come off during crimping due to a limited barrel length.

#### Brazed or Overlapped Seam

A long barrel design is of little value unless it is one solid piece. That is why Thomas & Betts brazes the seam on our vinyl insulated Sta-Kon® and overlaps the seam on nylon insulated terminals. Many competitive terminals have butted seams. This means increased chances for wirestrand loss, poor resistance, wire pullout and electrical failure. If the installer doesn’t position the tool exactly on the correct spot on the barrel, there’s likely going to be an improper termination. The butted seam can also fold due to tool-applied pressure piercing the terminal’s insulation from the inside out. With a brazed or overlapped seam the installer can crimp anywhere along the barrel’s surface providing up to 2.5 times the tensile strength of a butted seam terminal, guaranteeing proper electrical flow, void free.



• **Chamfered Funnel Barrel Entry.**

#### Deep Internal Serrations

After the insertion of a wire into the terminal’s barrel, a deep serrated interior insures a large area of contact which lowers the resistance of a connection. With the mechanical force of the tool, the wire strands cold flow into the serrated interior. This guarantees electrical resistance lower than the wire to which it is applied. This feature also prevents pullout from vibration and mechanical strain. Deep internal serrations can be compared to the effective holding power of a well treaded tire on a wet highway.

#### Sta-Kon’s® Long Barrel Design

If lowering electrical resistance, preventing wire pullout, eliminating a “missed” crimp and an insulator that stays on the barrel during installation



Strands enter as a homogeneous group and compact tightly under compression due to fully brazed seam

- **Selectively annealed long barrel.**
- **Longer barrel design.**
- **Color-code Tefzel®, Nylon or Vinyl Insulators.**
- **Brazed or overlapping seams.**

- **Anti-rotational tongue.**
- **Hardened tongue.**
- **Complete wire and stud size identification.**

K

Sta-Kon®

### Why Sta-Kon® Terminals Are Better – continued

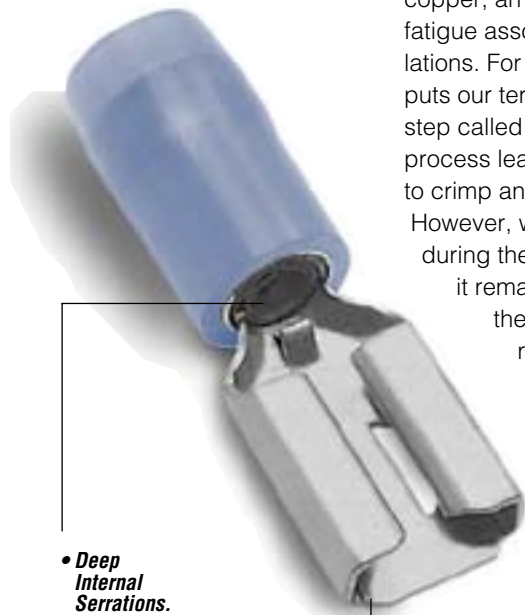

• **Deep Internal Serrations.**

- **Flat bottom box.**
- **Electro-tin plating.**
- **Center reinforced spring detent for minimum insertion force.**
- **Compound Spring Rails provide positive contact after repeated insertions.**

#### Selective Annealing

Because of the mechanical strength of copper, an installer can experience fatigue associated with repeated installations. For this reason Thomas & Betts puts our terminals through one more step called selective annealing. This process leaves the barrel soft enough to crimp and form around the wire. However, we “cold form” the tongue during the manufacturing process so it remains strong. This is done so the tongue can withstand repeated bends and bolt tightening strain common in most electrical installations. Many competitors attempt to accomplish similar goals by removing valuable material or using a softer copper which has lower conductivity. This increases electrical resistance as well as the odds for shorting and downtime.

#### Anti-Rotational Tongues

This is a unique feature to the Thomas & Betts ring tongue terminal. This design prevents terminal shorting by keeping the terminal secure in the terminal block. The installer can place a greater number of terminals closer together without worry.

#### Proper Identification

We identify all terminals with Thomas & Betts initials, T & B. We also indicate wire and stud sizes. These markings are clearly visible on the surface of the tongue, taking any guesswork out of replacing or reordering additional parts. Our superior bright plating also assists in visibility.

#### All Sta-Kon® Terminals are Deburred and Degreased

To insure a Sta-Kon® terminal is properly plated and insulated, all our parts are put through a process which cleans and smooths the terminal of any manufacturing by-products, mainly grease, oils and sharp edges. Many competitive products do not put their product through such rigorous finishing.

#### Platings/Finish

Electroplated-Tin is standard. All others require minimum order quantities and are generally not stocked. Alternative platings as follows: Gold, Silver, Tin-alloys, Nickel, etc. The following finishes are available on most one-piece Sta-Kon® terminals:

Finish	Suffix	Spec.
Gold Plate	<b>GP</b>	MIL-G-45204 Type II, Grade B, C, D, Class O
Nickel Plate	<b>NP</b>	QQ-N-290 Class 2, Grade G
Plain Finish	<b>PF</b>	None
Silver Plate	<b>SP</b>	MIL-T-16366 Type I or II, 400° F, 204° C
Tin Plate	<b>TP</b>	MIL-T-10727 Type I

To order add the indicated suffix to the regular catalog number.

#### Underwriters Laboratories Listing

Sta-Kon® Rings, Fork, and Locking Forks are tested and listed to U.L. 486A, two-way splices to U.L. 486C, disconnects to U.L. 310 and all applicable products to CSA 22.2.

**K**

Sta-Kon®

# Sta-Kon®

## Terminals



ERG-2001

### Sta-Kon® Ring, Fork & Locking Fork

- Complete line of installing tools engineered to match tool with terminal.
- First to gain military approval for pressure connections ... many styles available for military applications.
- Sta-Kon® products exceed test specification requirements of military, U.L. and CSA.
- TEFZEL® & Nylon Terminals provided with extra metal sleeve to grip insulation.
- Vinyl insulated and bare Sta-Kon® terminals feature brazed seam wire barrels which can be crimped at any place on the barrel circumference.

### Sta-Kon® Disconnects

- Internal barrel serrations and long barrel provide for maximum tensile strength.
- Complete line of installing tools, engineered to match tool with terminal.
- Funnel entry insulators allow for easier inserting of wire into barrel.
- Color-coded for easy installation.

### The Shure-Stake® Tools are Matched to Terminals

The Shure-Stake® mechanism prevents the dies from releasing the terminal until the proper compression has been completed. With this method, an operator achieves a reliable crimp everytime. Thomas & Betts' tooling techniques correctly match tools, wire size and terminal to produce optimum mechanical and electrical performance.

### Sta-Kon® Technical Data

Terminals & Splices Insulation Rating	U.L. 94 Flammability	Voltage	Temperature
Nylon	V-2	600V**	105°C
Vinyl	V-0	600V**	105°C
TEFZEL®	V-0	600V**	150°C
**1000V fixture or sign			
Disconnects		300V	105°C

### The Sta-Kon® Terminal Numbering System

Distributor Package 100/50  
Bulk "O.E.M." Packaged 1000/500

#### Common to Both Packages

- Letter **A** denotes 22-18 AWG wire range
- Letter **B** denotes 16-14 AWG wire range
- Letter **C** denotes 12-10 AWG wire range
- Letter **R** preceding the above letters indicates the terminal is insulated
- No letter **R**... no insulation ... no exception!

#### Distributor Packaged

Part numbers are very descriptive indicating insulation and type, stud size, tongue style and the largest maximum wire that can be put inside.

- If the letter **R** precedes the number the part is nylon insulated – RA18-6
- If the letter **R** follows the number the part is vinyl insulated – 14RB-8

#### EXAMPLE: 10RC-8F

C – Indicates 12-10 AWG  
10RC – Vinyl Insulated  
8 – Indicates stud size  
F – means a fork tongue terminal  
FL – would indicate locking fork

#### EXAMPLE: 2RA18X

2 – Indicates a 2 way or butt style connector  
X – means expanded insulation.

Tefzel® is a registered trademark of DuPont.

**Thomas & Betts**

# Sta-Kon®

## Terminals

### Performance Data

#### Voltage Drop Test 500 Cycles

Thomas & Betts terminals show consistently lower millivolt drops than those allowed by NEMA specification.

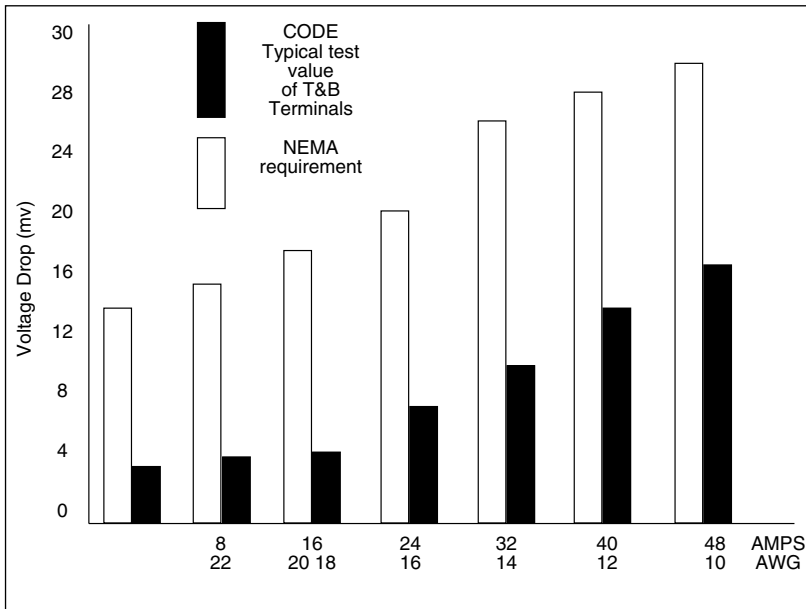

#### Wire Pullout Tension Test

Thomas & Betts terminals show consistently higher wire retention forces than those required by NEMA specification.

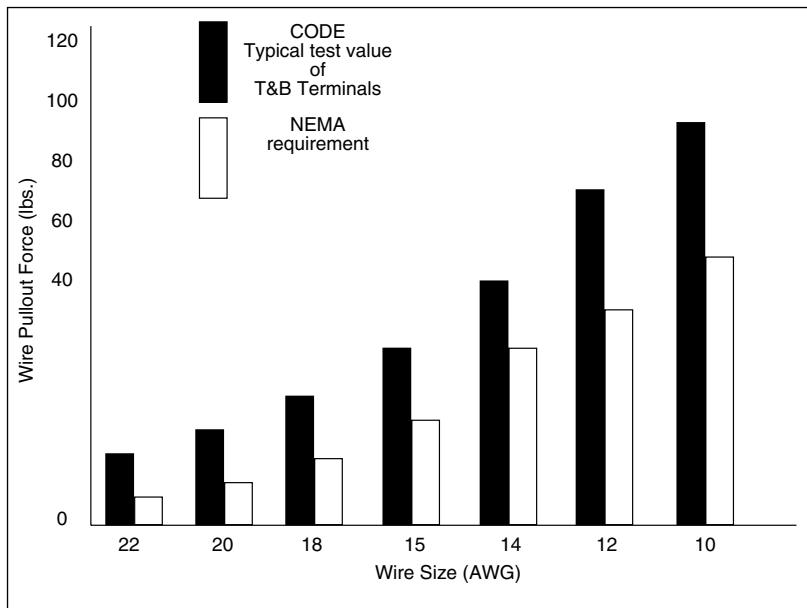

### The Proper Installation Procedure for the Quality Assured Connection

The proper installation of terminals, splices and connectors is very important to the efficient performance of an electrical system. The properly installed connector will allow good conductivity through the termination. A poor termination results in a high resistance connection. A poor connector installation may cause damage or failure of an entire system. Certain basic requirements must be met to make a good termination.

1. Before the connector or terminal is installed on the conductor, follow these recommended practices:
  - Strip the insulation carefully so as to avoid nicking or cutting conductor strands
  - Strip the insulation to the proper length so that the conductors can be inserted fully into the connector barrel; the wire/cable should be visible in the inspection hole of the lug; the proper strip length can be found on page K66.
2. Thomas & Betts wire strippers will help eliminate these problems by properly gaging and measuring the depth and length requirements for the conductor. See page K49 for wire strippers.

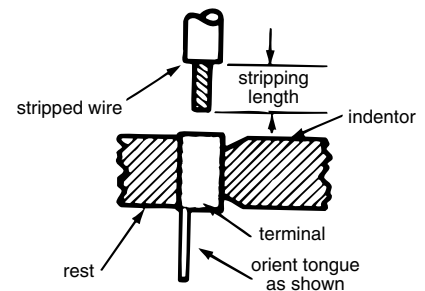

The terminal must be properly installed.

#### Installation Procedure

1. Train the wires to eliminate fanning of strands.
2. Open handles fully.
3. Insert terminal in proper die nest and locate it as shown above. When crimping a butt splice, position in proper die nest with window facing indenter.
4. Close handles slightly to secure terminal. Do not deform terminal.
5. Insert properly stripped wire into terminal.
6. Complete crimp by closing handles.

**Thomas & Betts**



Self-insulated with high dielectric-strength nylon sleeves, these ring terminals are recommended for temperatures up to 105°C. An inner bronze insulation grip sleeve lengthens the flexing radius of the conductor and eliminates conductor creep. The nylon jacket is color-coded:

Color Code	Wire Range
yellow	26-22
red	22-16
blue	18-14
yellow	12-10

Most standard bulk catalog numbers can be put on Mylar Tape for reel fed applications (i.e. 12050 tool and application dies). See pages K61- K62.

Please put the suffix M for Mylar Tape RA2573M.

(Bulk number 1000 and 500 packages.)

RZ & RAX stock thickness: .02  
 RA & RB stock thickness: .03  
 RC stock thickness: .04

### Nylon Insulated Ring – Insulation Grip

Cat. No.	Pkg. Qty.	Wire Range	Max. Ins.	Bolt Hole	Wt./Lbs. Per 1000	Dimensions			
						A	B	C	M
RZ22-2**	100	26-22	.083	#2	1	.57	.14	.13	.49
RZ22-4**	100	26-22	.083	#4	1	.65	.21	.20	.54
RZ22-6**	100	26-22	.083	#6	1	.65	.21	.20	.54
RZ22-8**	100	26-22	.083	#8	1	.75	.25	.23	.62
RZ22-10**	100	26-22	.083	#10	1	.75	.25	.23	.62
RAX23*	1000	26-24	.125	#2	3	.66	.14	.14	.59
RAX43*	1000	26-24	.125	#4	3	.74	.20	.19	.64
RAX63*	1000	26-24	.125	#6	3	.84	.25	.22	.72
RAX83*	1000	26-24	.125	#8	3	.84	.25	.22	.72
RAX103*	1000	26-24	.125	#10	3	.84	.25	.24	.72
RA18-4	100	22-16	.136	#4	2	.70	.23	.14	.59
RA323	1000	22-16	.136	#4	2	.70	.23	.14	.59
RA333	1000	22-16	.136	#6	2	.70	.23	.14	.59
RA18-6	100	22-16	.136	#6	2	.83	.26	.25	.71
RA853	1000	22-16	.136	#6	2	.83	.26	.25	.71
RA18-8	100	22-16	.136	#8	3	.83	.26	.25	.71
RA833	1000	22-16	.136	#8	3	.83	.26	.25	.71
RA863	1000	22-16	.136	#8	3	.83	.26	.25	.71
RA18-10	100	22-16	.136	#10	2	.86	.31	.25	.71
RA873	1000	22-16	.136	#10	2	.86	.31	.25	.71
RA18-14	100	22-16	.136	1/4"	3	1.07	.46	.31	.84
RA713	1000	22-16	.136	1/4"	3	1.07	.46	.31	.84
RA18-516	100	22-16	.136	5/16"	3	1.07	.46	.31	.84
RA723	1000	22-16	.136	5/16"	3	1.07	.46	.31	.84
RA18-38	100	22-16	.136	3/8"	3	1.17	.53	.35	.87
RA733	1000	22-16	.136	3/8"	3	1.17	.53	.35	.87
RA18-12	100	22-16	.136	1/2"	3	1.27	.72	.50	.92
RA753	1000	22-16	.136	1/2"	3	1.27	.72	.50	.92
RB14-4	100	18-14	.162	#4	2 1/2	.72	.26	.14	.59
RB1323	1000	18-14	.162	#4	2 1/2	.72	.26	.14	.59
RB14-6	100	18-14	.162	#6	3	.89	.31	.25	.71
RB853	1000	18-14	.162	#6	3	.89	.31	.25	.71
RB1333	1000	18-14	.162	#6	3	.74	.26	.14	.59
RB14-8	100	18-14	.162	#8	3	.89	.31	.25	.71
RB863	1000	18-14	.162	#8	3	.89	.31	.25	.71
RB14-10	100	18-14	.162	#10	3 1/2	.89	.31	.25	.71
RB873	1000	18-14	.162	#10	3 1/2	.89	.31	.25	.71
RB14-14	100	18-14	.162	1/4"	3 1/2	1.08	.47	.31	.81
RB713	1000	18-14	.162	1/4"	3 1/2	1.08	.47	.31	.81
RB14-516	100	18-14	.162	5/16"	3 1/2	1.08	.47	.31	.84
RB723	1000	18-14	.162	5/16"	3 1/2	1.08	.47	.31	.84
RB14-38	100	18-14	.162	3/8"	3 1/2	1.17	.53	.35	.87
RB733	1000	18-14	.162	3/8"	3 1/2	1.17	.53	.35	.87
RB14-12	100	18-14	.162	1/2"	4	1.25	.72	.50	.90
RB753	1000	18-14	.162	1/2"	4	1.25	.72	.50	.90
RC10-6	50	12-10	.210	#6	3	1.00	.37	.27	.81
RC333	500	12-10	.210	#6	3	1.00	.37	.27	.81
RC10-8	50	12-10	.210	#8	5	1.00	.37	.27	.81
RC863	500	12-10	.210	#8	5	1.00	.37	.27	.81
RC10-10	50	12-10	.210	#10	5	1.00	.37	.27	.81
RC363	500	12-10	.210	#10	5	1.00	.37	.27	.81
RC10-14	50	12-10	.210	1/4"	6	1.12	.53	.32	.86
RC713	500	12-10	.210	1/4"	6	1.12	.53	.32	.86
RC10-516	50	12-10	.210	5/16"	6	1.21	.53	.31	.94
RC703	500	12-10	.210	5/16"	6	1.21	.53	.31	.94
RC10-38	50	12-10	.210	3/8"	6	1.27	.59	.35	.98
RC733	500	12-10	.210	3/8"	6	1.27	.59	.35	.98
RC10-12	50	12-10	.210	1/2"	6	1.37	.72	.52	1.02
RC753	500	12-10	.210	1/2"	6	1.37	.72	.52	1.02

\* Not Listed By U.L. CSA

\*\* CSA Listed only

U.L. Listed E9809

Installing tools: WT2000, WT112M, WT145C, ERG-2001, ERG-2003, WT145A

Installing tool: WT1452 (RZ series only)

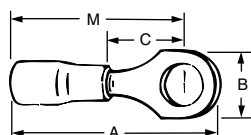



Catalog numbers with the suffix X indicate an expanded insulation grip. This means a wider wire entry to accommodate heavy wall insulation. Ring terminals won't fall free even if the mounting screw loosens.

RB stock thickness: .03  
RC stock thickness: .04

Most standard bulk catalog numbers can be put on Mylar Tape for reel fed applications (i.e. 12050 tool and application dies). See pages K61- K62. Please put the suffix M for Mylar Tape RA2573M. (Bulk number 1000 and 500 packages.)

### Nylon Insulated Ring – Expanded Insulation Grip

Cat. No.	Pkg. Qty.	Wire Range	Max. Ins.	Bolt Hole	Wt./Lbs. Per 1000	Dimensions			
						A	B	C	M
RB14-4X	100	18-14	.190	#4	4	.80	.26	.14	.67
RB1324	1000	18-14	.190	#4	4	.80	.26	.14	.67
RB14-6X	100	18-14	.190	#6	4	.95	.31	.25	.79
RB854	1000	18-14	.190	#6	4	.95	.31	.25	.79
RB14-8X	100	18-14	.190	#8	5	.95	.31	.25	.79
RB864	1000	18-14	.190	#8	5	.95	.31	.25	.79
RB14-10X	100	18-14	.190	#10	5	.95	.31	.25	.79
RB874	1000	18-14	.190	#10	5	.95	.31	.25	.79
RB14-14X	100	18-14	.190	1/4"	6	1.16	.47	.31	.92
RB714	1000	18-14	.190	1/4"	6	1.16	.47	.31	.92
RB14-516X	100	18-14	.190	5/16"	6	1.16	.47	.31	.92
RB724	1000	18-14	.190	5/16"	6	1.16	.47	.31	.92
RB14-38X	100	18-14	.190	3/8"	6	1.25	.53	.42	.95
RB734	1000	18-14	.190	3/8"	6	1.25	.53	.42	.95
RC10-6X	50	12-10	.250	#6	5	1.10	.37	.27	.91
RC334	500	12-10	.250	#6	5	1.10	.37	.27	.91
RC10-8X	50	12-10	.250	#8	5	1.10	.37	.27	.91
RC864	500	12-10	.250	#8	5	1.10	.37	.27	.91
RC10-10X	50	12-10	.250	#10	5	1.10	.37	.27	.91
RC364	500	12-10	.250	#10	5	1.10	.37	.27	.91
RC10-14X	50	12-10	.250	1/4"	6	1.22	.53	.32	.96
RC714	500	12-10	.250	1/4"	6	1.22	.53	.32	.96
RC10-516X	50	12-10	.250	5/16"	6	1.32	.53	.31	1.05
RC704	500	12-10	.250	5/16"	6	1.32	.53	.31	1.05
RC10-38X	50	12-10	.250	3/8"	6	1.38	.59	.48	1.09
RC734	500	12-10	.250	3/8"	6	1.38	.59	.48	1.09
RC10-12X	50	12-10	.250	1/2"	6	1.48	.72	.52	1.13

U.L. Listed E9809

Installing tools: WT2000, WT112M, WT145C, ERG-2001, ERG-2003, WT145A

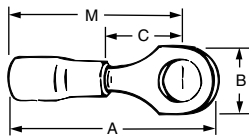

K

Sta-Kon®



*These ring terminals are self-insulated with heat shrinkable polyolefin and internally coated sealant. Upon completed installation, a fully sealed connection is achieved to protect the joint against the degrading effects of galvanic action, corrosion, and environmental exposure.*

**RAS & RBS stock thickness: .03**  
**RCS stock thickness: .04**

### Heat Shrinkable Ring Terminals – Expanded Insulation Support

Cat. No.	Pkg. Qty.	Wire Range	Max. Ins.	Bolt Hole	Wt./Lbs. Per 1000	Dimensions			
						A	B	C	M
<b>RAS18-6X</b>	100	22-18	.170	#6	2	1.23	.25	.27	1.10
<b>RAS18-8X</b>	100	22-18	.170	#8	3	1.26	.31	.27	1.10
<b>RAS18-10X</b>	100	22-18	.170	#10	2	1.26	.31	.27	1.10
<b>RBS14-6X</b>	100	16-14	.200	#6	3	1.23	.25	.27	1.10
<b>RBS14-8X</b>	100	16-14	.200	#8	3	1.23	.25	.27	1.10
<b>RBS14-10X</b>	100	16-14	.200	#10	3½	1.26	.31	.27	1.10
<b>RCS10-6X</b>	50	12-10	.250	#6	3	1.34	.31	.27	1.15
<b>RCS10-8X</b>	50	12-10	.250	#8	5	1.34	.37	.27	1.15
<b>RCS10-10X</b>	50	12-10	.250	#10	5	1.34	.37	.27	1.15
<b>RCS10-14X</b>	50	12-10	.250	¼"	6	1.34	.49	.32	1.15

U.L. Listed E9809

Installing tool: WT1255

Note: Not available on Mylar Tape.

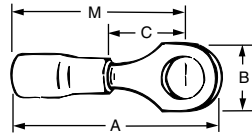



# Sta-Kon® Terminals



RD, RE, RF stock thickness: .04  
RG stock thickness: .05\*

## Nylon Insulated Ring

Cat. No.	Pkg. Qty.	Wire Range	Max. Ins.	Bolt Hole	Wt./Lbs. Per 1000	Dimensions			
						A	B	C	M
RD167	200	8	.340	#8	12	1.48	.42	.28	1.29
RD8-10	25	8	.340	#10	12	1.48	.42	.28	1.29
RD367	200	8	.340	#10	12	1.48	.42	.28	1.29
RD8-14	25	8	.340	1/4"	12	1.54	.46	.36	1.32
RD717	200	8	.340	1/4"	12	1.54	.46	.36	1.32
RD8-516	25	8	.340	5/16"	12	1.63	.57	.36	1.35
RD727	200	8	.340	5/16"	12	1.63	.57	.36	1.35
RD8-38	25	8	.340	3/8"	12	1.63	.57	.36	1.35
RD737	200	8	.340	3/8"	12	1.63	.57	.36	1.35
RD8-12	25	8	.310	1/2"	12	1.79	.82	.55	1.39
RD757*	200	8	.310	1/2"	12	1.79	.82	.55	1.39
RD10161	200	8AN	.270	#8	12	1.40	.41	.24	1.20
RD10361	200	8AN	.270	#10	12	1.40	.41	.24	1.20
RD10711	200	8AN	.270	1/4"	12	1.45	.45	.34	1.22
RD10721	200	8AN	.270	5/16"	12	1.53	.56	.34	1.25
RD10731	200	8AN	.270	3/8"	12	1.53	.56	.34	1.25
RE6-10	20	6	.420	#10	16	1.65	.49	.28	1.40
RE267	200	6	.420	#10	16	1.65	.49	.28	1.40
RE6-14	20	6	.420	1/4"	16	1.65	.49	.28	1.40
RE717	200	6	.420	1/4"	16	1.65	.49	.28	1.40
RE6-516	20	6	.420	5/16"	16	1.76	.61	.34	1.47
RE727	200	6	.420	5/16"	16	1.76	.61	.34	1.47
RE6-38	20	6	.420	3/8"	16	1.76	.61	.34	1.47
RE737	200	6	.420	3/8"	16	1.76	.61	.34	1.47
RE6-12	20	6	.395	1/2"	16	1.83	.82	.55	1.43
RE757*	200	6	.395	1/2"	16	1.83	.82	.55	1.43
RE10261	200	6AN	.315	#10	16	1.55	.49	.24	1.31
RE10711	200	6AN	.315	1/4"	16	1.55	.49	.27	1.31
RE10721	200	6AN	.315	5/16"	16	1.70	.60	.34	1.40
RE10731	200	6AN	.315	3/8"	16	1.70	.60	.34	1.40
RF4-10	15	4	.510	#10	21	1.76	.56	.36	1.49
RF267	200	4	.510	#10	21	1.76	.56	.36	1.49
RF4-14	15	4	.510	1/4"	21	1.76	.56	.36	1.49
RF717	200	4	.510	1/4"	21	1.76	.56	.36	1.49
RF4-516	15	4	.510	5/16"	21	1.84	.62	.35	1.53
RF727	200	4	.510	5/16"	21	1.84	.62	.35	1.53
RF4-38	15	4	.510	3/8"	23	1.84	.62	.35	1.53
RF737	200	4	.510	3/8"	23	1.84	.62	.35	1.53
RF757*	200	4	.500	1/2"	23	1.90	.82	.55	1.49
RF10261	200	4AN	.380	#10	26	1.78	.55	.30	1.51
RF10711	200	4AN	.380	1/4"	26	1.78	.55	.30	1.51
RF10721	200	4AN	.380	5/16"	26	1.80	.62	.34	1.49
RF10731	200	4AN	.380	3/8"	26	1.80	.62	.34	1.49
RG2-10	10	2	.588	#10	42	2.15	.69	.40	1.83
RG267	100	2	.588	#10	42	2.15	.69	.40	1.83
RG2-14	10	2	.588	1/4"	42	2.15	.69	.40	1.83
RG717	100	2	.588	1/4"	42	2.15	.69	.40	1.83
RG2-516	10	2	.588	5/16"	42	2.15	.69	.40	1.83
RG727	100	2	.588	5/16"	42	2.15	.69	.40	1.83
RG2-38	10	2	.588	3/8"	42	2.15	.69	.40	1.83
RG737	100	2	.588	3/8"	42	2.15	.69	.40	1.83
RG2-12	10	2	.588	1/2"	42	2.35	.80	.49	1.93
RG757	100	2	.588	1/2"	42	2.35	.80	.49	1.93
RG9711	100	1AN	.453	1/4"	48	2.07	.69	.40	1.74
RG9731	100	1AN	.453	3/8"	48	2.07	.69	.40	1.74
RG9751	100	1AN	.453	1/2"	48	2.26	.80	.49	1.84

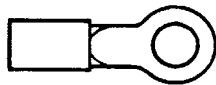

\*Braze Seam, Lolly-Pop Style Tongue.

AN – Aircraft Wire. U.L. Listed E9809. Installing tools: TBM6/TBM6S, ERG-2007, (RD & RE Except Braze Seam)  
Note: Not available on Mylar Tape.

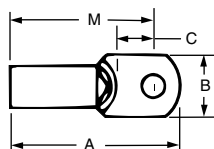

**Thomas & Betts**



**Stock Thickness:**  
 RH = .05  
 RJ = .06  
 RK = .06  
 RL = .07  
 RM = .07

### Nylon Insulated Ring – continued

Cat. No.	Pkg. Qty.	Wire Range	Max. Ins.	Bolt Hole	Wt./Lbs. Per 1000	Dimensions			
						A	B	C	M
RH9711	100	1AN	.500	1/4"	54	2.14	.77	.44	1.81
RH9731	100	1AN	.500	3/8"	54	2.14	.77	.44	1.81
RH9751	100	1AN	.500	1/2"	54	2.34	.77	.54	1.90
RJ9711	100	1/0AN	.550	1/4"	80	2.35	.83	.46	1.97
RJ9731	100	1/0AN	.550	3/8"	80	2.35	.83	.46	1.97
RJ9751	100	1/0AN	.550	1/2"	80	2.49	.89	.55	2.04
RH717	100	1/0	.629	1/4"	80	2.14	.77	.43	1.81
RH727	100	1/0	.629	5/16"	80	2.14	.77	.43	1.81
RH737	100	1/0	.629	3/8"	80	2.14	.77	.43	1.81
RH757	100	1/0	.629	1/2"	80	2.34	.77	.54	1.90
RK9731	100	2/0AN	.610	3/8"	70	2.52	.93	.55	2.14
RK9751	100	2/0AN	.610	1/2"	70	2.60	.93	.55	2.15
RJ717	100	2/0	.675	1/4"	80	2.34	.83	.46	1.96
RJ727	100	2/0	.675	5/16"	80	2.34	.83	.46	1.96
RJ737	100	2/0	.675	3/8"	80	2.34	.83	.46	1.96
RJ757	100	2/0	.675	1/2"	80	2.48	.89	.54	2.03
RL9731	100	3/0AN	.680	3/8"	120	2.83	1.04	.57	2.36
RL9751	100	3/0AN	.680	1/2"	120	2.83	1.04	.57	2.36
RK717	100	3/0	.765	1/4"	84	2.60	.93	.54	2.21
RK727	100	3/0	.765	5/16"	84	2.60	.93	.54	2.21
RK737	100	3/0	.765	3/8"	84	2.60	.93	.54	2.21
RM9731	100	4/0AN	.750	3/8"	160	3.00	1.13	.66	2.51
RM9751	100	4/0AN	.750	1/2"	160	3.00	1.13	.66	2.51
RL737	100	4/0	.785	3/8"	130	2.83	1.04	.57	2.35
RL757	100	4/0	.785	1/2"	130	2.83	1.04	.57	2.35
RM737	100	250MCM	.868	3/8"	130	3.00	1.13	.65	2.51
RM747	100	250MCM	.868	7/16"	130	3.00	1.13	.65	2.51
RM757	100	250MCM	.868	1/2"	130	3.00	1.13	.65	2.51

AN – Aircraft Wire

U.L. Listed E9809

Installing tools: TBM6/TBM6S, ERG-2007, (RD & RE Except Brazed Seam)

Note: Not available on Mylar Tape.

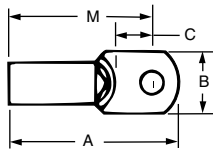

**K**

Sta-Kon®

# Sta-Kon®

## Terminals



These ring terminals are self-insulated with a PVC insulation sleeve of extra length to give protection and relieve bending stress at wire's flex point. Brazed seam barrel is serrated to obtain high pull-out value. Terminal is made of high conductivity electrolytic copper, electro-tin plated. Insulation material is color-coded:

Color Code	Wire Range
red	22-16
blue	18-14
yellow	12-10

Stock Thickness:

RA & RB	=	.03
RC	=	.04

Most standard bulk catalog numbers can be put on Mylar Tape for reel fed applications (i.e. 12050 tool and application dies). See pages K61- K62. Please put the suffix M for Mylar Tape RA2573M. (Bulk number 1000 and 500 packages.)

### Vinyl Insulated Ring – Insulation Grip

Cat. No.	Pkg. Qty.	Wire Range	Max. Ins.	Bolt Hole	Wt./Lbs. Per 1000	Dimensions			
						A	B	C	M
18RA-4	100	22-16	.150	#4	3	.97	.31	.27	.81
RA77	1000	22-16	.150	#4	3	.97	.31	.27	.81
18RA-6	100	22-16	.150	#6	3	.94	.25	.27	.81
RA857	1000	22-16	.150	#6	3	.94	.25	.27	.81
18RA-8	100	22-16	.150	#8	3	.97	.31	.27	.81
RA867	1000	22-16	.150	#8	3	.97	.31	.27	.81
18RA-10	100	22-16	.150	#10	3	.97	.31	.27	.81
RA877	1000	22-16	.150	#10	3	.97	.31	.27	.81
18RA-14	100	22-16	.150	1/4"	4	1.13	.50	.37	.88
RA717	1000	22-16	.150	1/4"	4	1.13	.50	.37	.88
18RA-516	100	22-16	.150	5/16"	4	1.13	.50	.37	.88
RA727	1000	22-16	.150	5/16"	4	1.13	.50	.37	.88
18RA-38	100	22-16	.150	3/8"	4	1.24	.54	.37	.91
RA737	1000	22-16	.150	3/8"	4	1.24	.54	.37	.91
14RB-4	100	18-14	.170	#4	3	.94	.25	.27	.81
RB1327	1000	18-14	.170	#4	3	.94	.25	.27	.81
14RB-6	100	18-14	.170	#6	3	.97	.31	.27	.81
RB857	1000	18-14	.170	#6	3	.97	.31	.27	.81
14RB-8	100	18-14	.170	#8	3	.97	.31	.27	.81
RB867	1000	18-14	.170	#8	3	.97	.31	.27	.81
14RB-10	100	18-14	.170	#10	3	.97	.31	.27	.81
RB877	1000	18-14	.170	#10	3	.97	.31	.27	.81
14RB-14	100	18-14	.170	1/4"	4	1.14	.50	.38	.89
RB717	1000	18-14	.170	1/4"	4	1.14	.50	.38	.89
14RB-516	100	18-14	.170	5/16"	4	1.15	.50	.38	.89
RB727	1000	18-14	.170	5/16"	4	1.15	.50	.38	.89
14RB-38	100	18-14	.170	3/8"	4	1.16	.54	.38	.91
RB-737	1000	18-14	.170	3/8"	4	1.16	.54	.38	.91
10RC-6	50	12-10	.210	#6	5	1.06	.31	.27	.90
RC337	500	12-10	.210	#6	5	1.06	.31	.27	.90
10RC-8	50	12-10	.210	#8	5	1.06	.31	.27	.90
RC777	500	12-10	.210	#8	5	1.06	.31	.27	.90
10RC-10	50	12-10	.210	#10	5	1.06	.31	.27	.90
RC367	500	12-10	.210	#10	5	1.06	.31	.27	.90
10RC-14	50	12-10	.210	1/4"	6	1.16	.50	.27	.90
RC717	500	12-10	.210	1/4"	6	1.16	.50	.27	.90
10RC-516	50	12-10	.210	5/16"	6	1.17	.50	.37	.92
RC707	500	12-10	.210	5/16"	6	1.17	.50	.37	.92
10RC-38	50	12-10	.210	3/8"	6	1.29	.59	.44	.99
RC737	500	12-10	.210	3/8"	6	1.29	.59	.44	.99

U.L. Listed E9809

Installing tools: WT145C, WT2000, WT112M, ERG-2001, ERG-2003

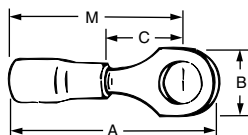

K Sta-Kon®



Catalog numbers with the suffix X indicate an expanded insulation support. This means a wider wire entry to accommodate heavy wall insulation. Ring terminals won't fall free even if the mounting screw loosens.

Stock Thickness:  
RA & RB = .03  
RC = .04

Most standard bulk catalog numbers can be put on Mylar Tape for reel fed applications (i.e. 12050 tool and application dies). See pages K61- K62. Please put the suffix M for Mylar Tape RA2573M. (Bulk number 1000 and 500 packages.)

### Vinyl Insulated Ring – Expanded Insulation Support

Cat. No.	Pkg. Qty.	Wire Range	Max. Ins.	Bolt Hole	Wt./Lbs. Per 1000	Dimensions			
						A	B	C	M
18RA-6X	100	22-16	.170	#6	3	.97	.31	.27	.81
18RA-8X	100	22-16	.170	#8	3	.97	.31	.27	.81
RA867-170	1000	22-16	.170	#8	3	.97	.31	.27	.81
18RA-10X	100	22-16	.170	#10	3	.97	.31	.27	.81
RA877-170	1000	22-16	.170	#10	3	.97	.31	.27	.81
18RA-14X	100	22-16	.170	1/4"	4	1.13	.50	.37	.88
RA727-170	1000	22-16	.170	5/16"	4	1.13	.50	.37	.88
14RB-4X	100	18-14	.200	#4	3	.94	.25	.27	.81
14RB-6X	100	18-14	.200	#6	3	.97	.31	.27	.81
RB857-200	1000	18-14	.200	#6	3	.97	.31	.27	.81
14RB-8X	100	18-14	.200	#8	3	.97	.31	.27	.81
RB867-200	1000	18-14	.200	#8	3	.97	.31	.27	.81
14RB-10X	100	18-14	.200	#10	3	.97	.31	.27	.81
RB877-200	1000	18-14	.200	#10	3	.97	.31	.27	.81
14RB-14X	100	18-14	.200	1/4"	4	1.14	.50	.38	.89
RB717-200	1000	18-14	.200	1/4"	4	1.14	.50	.38	.89
14RB-516X	100	18-14	.200	5/16"	4	1.15	.50	.38	.89
14RB-38X	100	18-14	.200	3/8"	4	1.16	.54	.35	.91
10RC-6X	50	12-10	.250	#6	5	1.06	.31	.27	.90
RC337-250	500	12-10	.250	#6	5	1.06	.31	.27	.90
10RC-8X	50	12-10	.250	#8	5	1.06	.31	.27	.90
RC777-250	500	12-10	.250	#8	5	1.06	.31	.27	.90
10RC-10X	50	12-10	.250	#10	5	1.06	.31	.27	.90
RC367-250	500	12-10	.250	#10	5	1.06	.31	.27	.90
10RC-14X	50	12-10	.250	1/4"	6	1.16	.50	.27	.90
RC717-250	500	12-10	.250	1/4"	6	1.16	.50	.27	.90
10RC-516X	50	12-10	.250	5/16"	6	1.17	.50	.37	.92
10RC-38X	50	12-10	.250	3/8"	6	1.29	.59	.44	.99
RC737-250	500	12-10	.250	3/8"	6	1.29	.59	.44	.99

U.L. Listed E9809

Installing tools: WT145C, WT2000, WT112M, ERG-2001, ERG-2003

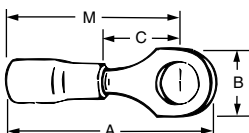

K

Sta-Kon®

# Sta-Kon®

## Terminals



These non-insulated ring terminals are made of electrolytic copper for high conductivity. They can be installed with crimping tools having a single indenter or double indenter (recommended for solid wire). Serrated barrel increases grip on wire. Wire range identification is stamped on the tongue of each terminal.

Most standard bulk catalog numbers can be put on Mylar Tape for reel fed applications (i.e. 12050 tool and applicator dies). See pages K61- K62.

Please put the suffix M for Mylar Tape RA2573M.

(Bulk number 1000 and 500 packages.)

Stock Thickness:  
A & B = .03  
BC = .05  
C = .04

### Non-Insulated Ring

Cat. No.	Pkg. Qty.	Wire Range	Bolt Hole	Wt./Lbs. Per 1000	Dimensions			
					A	B	C	M
A18-4	100	22-16	#4	2	.75	.31	.27	.59
A18-6	100	22-16	#6	2	.72	.25	.27	.59
A85	1000	22-16	#6	2	.72	.25	.27	.59
A18-8	100	22-16	#8	2	.75	.31	.27	.59
A86	1000	22-16	#8	2	.75	.31	.27	.59
A18-10	100	22-16	#10	2	.75	.31	.27	.59
A87	1000	22-16	#10	2	.75	.31	.27	.59
A18-14	100	22-16	1/4"	3	.92	.50	.37	.67
A71	1000	22-16	1/4"	3	.92	.50	.37	.67
A18-516	100	22-16	5/16"	3	.92	.50	.37	.67
A72	1000	22-16	5/16"	3	.92	.50	.37	.67
A18-38	100	22-16	3/8"	3	.99	.54	.35	.67
A73	1000	22-16	3/8"	3	.99	.54	.35	.67
A18-12	100	22-16	1/2"	3	1.06	.72	.38	.70
A75	1000	22-16	1/2"	3	1.06	.72	.38	.70
B14-4	100	18-14	#4	2	.72	.25	.27	.59
B132	1000	18-14	#4	2	.72	.25	.27	.59
B14-6	100	18-14	#6	2	.75	.31	.27	.59
B133	1000	18-14	#6	2	.75	.31	.27	.59
B14-8	100	18-14	#8	3	.75	.31	.27	.59
B86	1000	18-14	#8	3	.75	.31	.27	.59
B14-10	100	18-14	#10	3	.75	.31	.27	.59
B87	1000	18-14	#10	3	.75	.31	.27	.59
B14-14	100	18-14	1/4"	6	.93	.50	.38	.68
B71	1000	18-14	1/4"	6	.93	.50	.38	.68
B14-516	100	18-14	5/16"	6	.93	.50	.38	.68
B72	1000	18-14	5/16"	6	.93	.50	.38	.68
B14-38	100	18-14	3/8"	6	.96	.54	.35	.68
B73	1000	18-14	3/8"	6	.96	.54	.35	.68
B14-12	100	18-14	1/2"	6	1.06	.72	.38	.70
B75	1000	18-14	1/2"	6	1.06	.72	.38	.70
B85	1000	18-14	#6	6	.75	.31	.27	.59
B134	1000	18-14	#8	6	.72	.25	.27	.59
BC14-6	50	heavy duty 16-14	#6	4	.81	.25	.29	.68
BC85	500	use C tooling	#6	4	.81	.25	.29	.68
BC14-8	50	heavy duty 16-14	#8	4	.87	.39	.29	.68
BC86	500	use C tooling	#8	4	.87	.39	.29	.68
BC14-10	50	heavy duty 16-14	#10	5	.87	.39	.29	.68
BC87	500	use C tooling	#10	5	.87	.39	.29	.68
BC14-14	50	heavy duty 16-14	1/4"	5	.93	.51	.29	.68
BC71	500	use C tooling	1/4"	5	.93	.51	.29	.68
BC14-516	50	heavy duty 16-14	5/16"	6	1.04	.54	.38	.77
BC72	500	use C tooling	5/16"	6	1.04	.54	.38	.77
BC14-38	50	heavy duty 16-14	3/8"	6	1.09	.63	.38	.77
BC79	500	use C tooling	3/8"	6	1.09	.63	.38	.77
BC14-12	50	heavy duty 16-14	1/2"	6	1.32	.76	.54	.94
BC75	500	use C tooling	1/2"	6	1.32	.76	.54	.94
C10-6	50	12-10	#6	4	.82	.31	.27	.66
C33	500	12-10	#6	4	.82	.31	.27	.66
C10-8	50	12-10	#8	5	.82	.31	.27	.66
C77	500	12-10	#8	5	.82	.31	.27	.66
C10-10	50	12-10	#10	5	.85	.38	.27	.66
C26	500	12-10	#10	5	.85	.38	.27	.66
C36	1000	12-10	#10	7	.82	.31	.27	.66
C10-14	50	12-10	1/4"	7	.91	.50	.27	.66
C71	500	12-10	1/4"	7	.91	.50	.27	.66
C10-516	50	12-10	5/16"	8	.98	.50	.38	.73
C70	500	12-10	5/16"	8	.98	.50	.38	.73
C72	1000	12-10	5/16"	7	1.10	.59	.45	.80
C10-38	50	12-10	3/8"	7	1.10	.59	.45	.80
C73	500	12-10	3/8"	7	1.10	.59	.45	.80
C10-12	50	12-10	1/2"	7	1.21	.72	.38	.84
C75	500	12-10	1/2"	7	1.21	.72	.38	.84

U.L. Listed E9809

Installing tools: WT111M, WT112M, WT110M, ERG-2002, WT2000

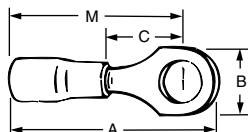

**Thomas & Betts**



These non-insulated ring terminals are made of electrolytic copper for high conductivity. They can be installed with crimping tools having a single indenter or double indenter (recommended for solid wire). Serrated barrel increases grip on wire. Wire range identification is stamped on the tongue of each terminal.

Stock Thickness:

D & E = .06

F = .07

D10, E10, F10 = .04

D975 & F975 = .04

### Non-Insulated Ring – Brazed Seam

Cat. No.	Pkg. Qty.	Wire Range	Bolt Hole	Wt./Lbs. Per 1000	Dimensions			
					A	B	C	M
D8-10*	25	8	#10	16	1.13	.48	.36	.90
D36*	200	8	#10	16	1.13	.48	.36	.90
D8-14*	25	8	1/4"	14	1.13	.48	.36	.90
D71*	200	8	1/4"	14	1.13	.48	.36	.90
D8-516*	25	8	5/16"	16	1.32	.59	.49	1.03
D72*	200	8	5/16"	16	1.32	.59	.49	1.03
D8-38*	25	8	3/8"	14	1.32	.59	.49	1.03
D73*	200	8	3/8"	14	1.32	.59	.49	1.03
D8-12*	25	8	1/2"	14	1.49	.82	.55	1.09
D75*	200	8	1/2"	14	1.49	.82	.55	1.09
E6-10*	20	6	#10	17	1.13	.48	.36	.90
E26*	200	6	#10	17	1.13	.48	.36	.90
E6-14*	20	6	1/4"	20	1.13	.48	.36	.90
E71*	200	6	1/4"	20	1.13	.48	.36	.90
E6-516*	20	6	5/16"	20	1.32	.60	.49	1.03
E72*	200	6	5/16"	20	1.32	.60	.49	1.03
E6-38*	20	6	3/8"	20	1.32	.60	.49	1.03
E73*	200	6	3/8"	20	1.32	.60	.49	1.03
E6-12*	20	6	1/2"	20	1.49	.82	.55	1.08
E75*	200	6	1/2"	20	1.49	.82	.55	1.08
F4-10*	20	4	#10	24	1.16	.48	.36	.93
F26*	200	4	#10	24	1.16	.48	.36	.93
F4-14*	20	4	1/4"	25	1.16	.48	.36	.93
F71*	200	4	1/4"	25	1.16	.48	.36	.93
F4-516*	20	4	5/16"	25	1.35	.60	.49	1.06
F72*	200	4	5/16"	25	1.35	.60	.49	1.06
F4-38*	20	4	3/8"	25	1.35	.60	.49	1.06
F73*	200	4	3/8"	25	1.35	.60	.49	1.06
F4-12*	20	4	1/2"	25	1.52	.82	.55	1.11
F75*	200	4	1/2"	25	1.52	.82	.55	1.11

Installing tools: ERG-2005 (D Series only), WT115A D, E, F and G, TBM6/TBM6S, WT3185

Installing dies: 11802 INDENTOR (D-E-F-G), D-11803-NEST, E-11805-NEST, F-11806-NEST (all ordered separately)

Not available on Mylar Tape.

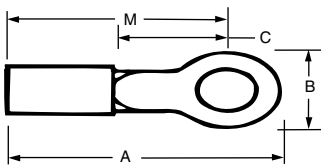

K

Sta-Kon®

# Sta-Kon® Terminals



*These non-insulated ring terminals are made of electrolytic copper for high conductivity. They can be installed with crimping tools having a single indenter or double indenter (re commended for solid wire). Serrated barrel increases grip on wire. Wire range identification is stamped on the tongue of each terminal.*

**Stock Thickness:**  
G & H = .05  
J & K = .06  
L & M = .07

## Non-Insulated Ring – Tubular

Cat. No.	Pkg. Qty.	Wire Range	Bolt Hole	Wt./Lbs. Per 1000	Dimensions			
					A	B	C	M
D10161	200	8	#8	12	1.15	.41	.28	.95
D10361	200	8	#10	12	1.15	.41	.28	.95
D10711	200	8	1/4"	12	1.20	.45	.36	.97
D10721	200	8	5/16"	12	1.28	.56	.36	1.00
D10731	200	8	3/8"	12	1.28	.56	.36	1.00
D975*	200	8	1/2"	12	1.46	.83	.49	1.06
E10261	200	6	#10	14	1.26	.49	.24	1.02
E10711	200	6	1/4"	14	1.26	.49	.27	.99
E10721	200	6	5/16"	14	1.38	.60	.34	1.04
E10731	200	6	3/8"	14	1.38	.60	.34	1.04
F10261	100	4	#10	20	1.37	.55	.30	1.07
F10711	100	4	1/4"	20	1.37	.55	.30	1.07
F10721	100	4	5/16"	20	1.42	.62	.34	1.08
F10731	100	4	3/8"	20	1.42	.62	.34	1.08
F975*	200	4	1/2"	20	1.49	.83	.45	1.10
G2-14	10	2	1/4"	50	1.59	.69	.40	1.26
G2-516	10	2	5/16"	50	1.59	.69	.40	1.26
G2-38	10	2	3/8"	50	1.59	.69	.40	1.26
G2-12	10	2	1/2"	50	1.79	.80	.49	1.36
G926	100	2	#10	40	1.59	.69	.40	1.26
G971	100	2	1/4"	40	1.59	.69	.40	1.26
G972	100	2	5/16"	40	1.59	.69	.40	1.26
G973	100	2	3/8"	40	1.59	.69	.40	1.26
G975	100	2	1/2"	40	1.79	.80	.49	1.36
H971	100	1AN-1/0	1/4"	50	1.65	.77	.43	1.32
H972	100	1AN-1/0	5/16"	50	1.65	.77	.43	1.32
H973	100	1AN-1/0	3/8"	50	1.65	.77	.43	1.32
H975	100	1AN-1/0	1/2"	50	1.85	.77	.54	1.41
H10-14	10	1/0	1/4"	50	1.65	.77	.43	1.32
J971	50	1/0AN-2/0	1/4"	60	1.94	.84	.48	1.53
J972	50	1/0AN-2/0	5/16"	60	1.94	.84	.48	1.53
J973	50	1/0AN-2/0	3/8"	60	1.99	.84	.53	1.58
J974	50	1/0AN-2/0	7/16"	60	1.99	.89	.51	1.56
J975	50	1/0AN-2/0	1/2"	60	1.99	.89	.51	1.56
J20-38	10	2/0	3/8"	70	1.84	.83	.46	1.46
K971	50	2/0AN-3/0	1/4"	76	2.08	.93	.54	1.69
K972	50	2/0AN-3/0	5/16"	76	2.08	.93	.54	1.69
K973	50	2/0AN-3/0	3/8"	76	2.08	.93	.54	1.69
K974	50	2/0AN-3/0	7/16"	76	2.08	.93	.54	1.70
K975	50	2/0AN-3/0	1/2"	76	2.08	.93	.54	1.70
K30-38	5	3/0	3/8"	82	2.08	.93	.54	1.69
L973	50	3/0AN-4/0	3/8"	92	2.25	1.04	.57	1.77
L974	50	3/0AN-4/0	7/16"	92	2.25	1.04	.57	1.77
L975	50	3/0AN-4/0	1/2"	92	2.25	1.04	.57	1.77
L40-38	5	4/0	3/8"	100	2.25	1.04	.57	1.77
M972	50	4/0AN-250MCM	5/16"	112	2.28	1.12	.62	1.90
M973	50	4/0AN-250MCM	3/8"	112	2.40	1.12	.65	1.91
M974	50	4/0AN-250MCM	7/16"	112	2.40	1.12	.65	1.91
M975	50	4/0AN-250MCM	1/2"	112	2.40	1.12	.65	1.91
M250-38	5	250MCM	3/8"	135	2.40	1.12	.65	1.91

AN – Aircraft Wire

Installing tools: TBM6/TBM6S, WT3185 (G, H, J Series only)

Note: Not available on Mylar Tape.

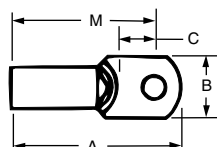

**Thomas & Betts**

K  
Sta-Kon®

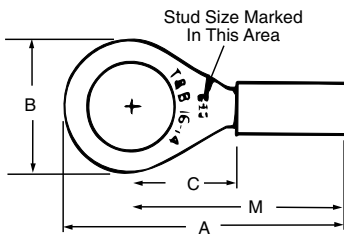

Nylon or Vinyl Insulated

**Most standard bulk catalog numbers can be put on Mylar Tape for reel fed applications (i.e. 12050 tool and application dies). See pages K61- K62. Please put the suffix M for Mylar Tape RA2573M. (Bulk number 1000 and 500 packages.)**

**K**

Sta-Kon®

Material: copper .050 thk.  
Finish: electro tin-plate  
Wire Range: #16-14  
Color Code: green vinyl or nylon insulator

## Nylon #16-14 AWG – Heavy Duty

Cat. No.	Pkg. Qty.	Wire Range	Max. Ins.	Bolt Hole	Wt./Lbs. Per 1000	Dimensions			
						A	B	C	M
RBC14-6	50	16-14 heavy duty	.210	#6		.98	.25	.29	.85
RBC853	500	use RC tooling	.210	#6		.98	.25	.29	.85
RBC14-8	50	16-14 heavy duty	.210	#8		1.04	.39	.29	.85
RBC863	500	use RC tooling	.210	#8		1.04	.39	.29	.85
RBC14-10	50	16-14 heavy duty	.210	#10		1.04	.39	.29	.85
RBC873	500	use RC tooling	.210	#10		1.04	.39	.29	.85
RBC14-14	50	16-14 heavy duty	.210	1/4		1.10	.51	.29	.85
RBC713	500	use RC tooling	.210	1/4		1.10	.51	.29	.85
RBC14-516	50	16-14 heavy duty	.210	5/16		1.21	.54	.38	.94
RBC723	500	use RC tooling	.210	5/16		1.21	.54	.38	.94
RBC14-38	50	16-14 heavy duty	.210	3/8		1.26	.63	.38	.94
RBC793	500	use RC tooling	.210	3/8		1.26	.63	.38	.94
RBC14-12	50	16-14 heavy duty	.210	1/2		1.49	.76	.54	1.11
RBC753	500	use RC tooling	.210	1/2		1.49	.76	.54	1.11

WT2000, WT145C, and power tools as recommended crimp in the 12-10 nest (yellow)

## Vinyl #16-14 AWG – Heavy Duty

Cat. No.	Pkg. Qty.	Wire Range	Max. Ins.	Bolt Hole	Wt./Lbs. Per 1000	Dimensions			
						A	B	C	M
14RBC-6	50	16-14 heavy duty	.210	#6	5	1.06	.25	.29	.93
RBC857	500	use RC tooling	.210	#6	5	1.06	.25	.29	.93
14RBC-8	50	16-14 heavy duty	.210	#8	5	1.13	.39	.29	.93
RBC867	500	use RC tooling	.210	#8	5	1.13	.39	.29	.93
14RBC-10	50	16-14 heavy duty	.210	#10	5	1.13	.39	.29	.93
RBC877	500	use RC tooling	.210	#10	5	1.13	.39	.29	.93
14RBC-14	50	16-14 heavy duty	.210	1/4	6	1.19	.51	.29	.93
RBC717	500	use RC tooling	.210	1/4	6	1.19	.51	.29	.93
14RBC-516	50	16-14 heavy duty	.210	5/16	6	1.29	.54	.38	1.03
RBC727	500	use RC tooling	.210	5/16	6	1.29	.54	.38	1.03
14RBC-38	50	16-14 heavy duty	.210	3/8	6	1.34	.63	.38	1.03
RBC797	500	use RC tooling	.210	3/8	6	1.34	.63	.38	1.03
14RBC-12	50	16-14 heavy duty	.210	1/2	6	1.57	.76	.54	1.19
RB757	500	use RC tooling	.210	1/2	6	1.57	.76	.54	1.19

## Non-Insulated #16-14 AWG – Heavy Duty

Cat. No.	Pkg. Qty.	Wire Range	Max. Ins.	Bolt Hole	Wt./Lbs. Per 1000	Dimensions			
						A	B	C	M
BC14-6	100	16-14 heavy duty	–	#6		.81	.25	.29	.68
BC85	1000	use RC tooling		#6		.81	.25	.29	.68
BC14-8	100	16-14 heavy duty	–	#8		.87	.39	.29	.68
BC86	1000	use RC tooling		#8		.87	.39	.29	.68
BC14-10	100	16-14 heavy duty	–	#10		.87	.39	.29	.68
BC87	1000	use RC tooling		#10		.87	.39	.29	.68
BC14-14	100	16-14 heavy duty	–	1/4		.93	.51	.29	.68
BC71	1000	use RC tooling		1/4		.93	.51	.29	.68
BC14-516	100	16-14 heavy duty	–	5/16		1.04	.54	.38	.77
BC72	1000	use RC tooling		5/16		1.04	.54	.38	.77
BC14-38	100	16-14 heavy duty	–	3/8		1.09	.63	.38	.77
BC79	1000	use RC tooling		3/8		1.09	.63	.38	.77
BC14-12	100	16-14 heavy duty	–	1/2		1.32	.76	.54	.94
BC75	1000	use RC tooling		1/2		1.32	.76	.54	.94

WT111M, WT2000, and power tools as recommended, crimp in the 12-10 nest

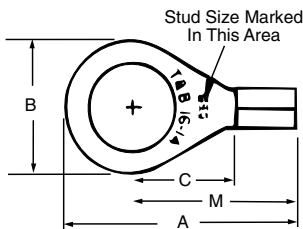

Non-Insulated



# Sta-Kon<sup>®</sup>

## Terminals



*For easily installed, permanent terminations of solid, round, or stranded nichrome wires as used in toasters, irons, heaters, etc. High temperature non-insulated ring terminals and splices are designed for use with solid or stranded resistance wires as used in appliances such as toasters, irons, and heaters.*

**Stock Thickness:**  
 24-22 ga. = .032  
 20-18 ga. = .032  
 16-14 ga. = .040  
 12-10 ga. = .040

### High Temperature Non-Insulated Ring – 1200°F Max.

#### Terminals for nichrome wire NW Series

Cat. No.	Pkg. Qty.	Wire Range	Bolt Hole	Wt./Lbs. Per 1000	Dimensions			
					A	B	C	M
NW21	1000	24-22	#6	1.5	.59	.31	.28	.44
NW22	1000	24-22	#8	1.5	.59	.31	.28	.44
NW23	1000	24-22	#10	1.5	.59	.31	.28	.44
NW18-10	100	20-18	#10	2.5	.63	.31	.28	.38
NW52	1000	20-18	#8	2.5	.63	.31	.28	.38
NW81	1000	16-14	#6	2.5	.66	.31	.28	.51
NW14-8	100	16-14	#8	2.5	.66	.31	.28	.51
NW14-10	100	16-14	#10	2.5	.66	.31	.28	.51
NW83	1000	16-14	#10	2.5	.66	.31	.28	.51
NW14-12	100	16-14	#12 *	2.5	.66	.31	.28	.51
NW84	1000	16-14	#12 *	2.5	.66	.31	.28	.51
NW10-8	50	12-10	#8	3	.66	.31	.28	.51
NW10-10	50	12-10	#10	3	.66	.31	.28	.51
NW10-12	50	12-10	#12 *	3	.66	.31	.28	.51

\* #12 stud is approximate ¼" stud.

Installing tool: WT1377

Note: Not available on Mylar Tape.

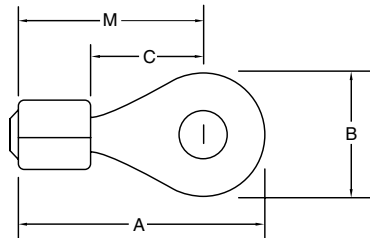

**K**

Sta-Kon<sup>®</sup>

**Thomas & Betts**



Stock Thickness: .04

### Vinyl Insulated Ring

Cat. No.	Stud Size	Max. Ins. Dia.	Wire Range	Dimensions			
				A	B	C	M
<b>Series RDV – Aircraft Wire AN</b>							
RDV10161	#8	.270	8	1.40	.41	.24	1.20
RDV10361	#10	.270	8	1.40	.41	.24	1.20
RDV10711	1/4"	.270	8	1.45	.45	.27	1.22
RDV10721	5/16"	.270	8	1.53	.56	.34	1.25
RDV10731	3/8"	.270	8	1.53	.56	.34	1.25
<b>Code Wire AWG</b>							
RDV167	#8	.340	8	1.48	.42	.28	1.29
RDV367	#10	.340	8	1.48	.42	.28	1.29
RDV717	1/4"	.340	8	1.54	.46	.36	1.32
RDV727	5/16"	.340	8	1.63	.57	.36	1.35
RDV737	3/8"	.340	8	1.63	.57	.36	1.35
RDV757*	1/2"	.310	8	1.79	.82	.55	1.39
<b>Series REV – Aircraft Wire AN</b>							
REV10261	#10	.315	6	1.55	.45	.24	1.31
REV10711	1/4"	.315	6	1.55	.49	.27	1.31
REV10721	5/16"	.315	6	1.70	.60	.34	1.40
REV10731	3/8"	.315	6	1.70	.60	.34	1.40
<b>Code Wire AWG</b>							
REV267	#10	.420	6	1.65	.45	.28	1.40
REV717	1/4"	.420	6	1.65	.49	.28	1.40
REV727	5/16"	.420	6	1.76	.61	.34	1.47
REV737	3/8"	.420	6	1.76	.61	.34	1.47
REV757*	1/2"	.395	6	1.83	.82	.55	1.43

Note: Not available on Mylar Tape.  
Installing tool: ERG-2007 (RD & RE Except Brazed Seam), TBN6/65

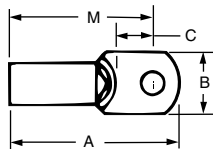
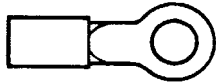

\*Brazed Seam, Lolly-Pop Style Tongue

K

Sta-Kon®

# Sta-Kon® Terminals



**Stock Thickness:**  
RAT & RBT = .03  
RCT = .04

**Package Quantities:**  
RAT & RBT = 1000 pcs.  
RCT = 500 pcs.

**Most standard bulk catalog numbers can be put on Mylar Tape for reel fed applications (i.e. 12050 tool and application dies). See pages K61- K62. Please put the suffix M for Mylar Tape RA2573M. (Bulk number 1000 and 500 packages.)**

## Tefzel® Insulated Ring – Insulation Grip

Cat. No.	Stud Size	Max. Ins. Dia.	Wire Range	Dimensions			
				A	B	C	M
<b>Series RAT – For U.L. 94V-O Flammability Rating/High Temperature and Chemical Resistance.</b>							
RAT853	#6	.140	22-18	.81	.25	.25	.69
RAT863	#8	.140	22-18	.84	.31	.25	.69
RAT873	#10	.140	22-18	.84	.31	.25	.69
RAT713	¼"	.140	22-18	1.07	.46	.31	.84
<b>Series RBT</b>							
RBT853	#6	.170	16-14	.84	.31	.25	.69
RBT863	#8	.170	16-14	.84	.31	.25	.69
RBT873	#10	.170	16-14	.84	.31	.25	.69
RBT713	¼"	.170	16-14	1.08	.46	.31	.81
<b>Series RCT</b>							
RCT333	#6	.210	12-10	1.00	.37	.27	.81
RCT863	#8	.210	12-10	1.00	.37	.27	.81
RCT363	#10	.210	12-10	1.00	.37	.27	.81
RCT713	¼"	.210	12-10	1.11	.52	.32	.85
RCT703	⅝"	.210	12-10	1.23	.52	.31	.96
RCT733**	¾"	.210	12-10	1.29	.58	.35	1.00

\*\* Not available on tape.

U.L. Listed E9809

Installing tool: WT145C, WT112M

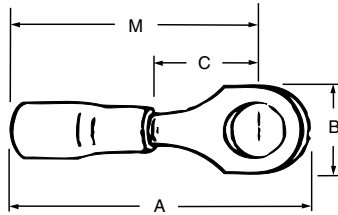

Tefzel® is a registered trademark of DuPont.

**K**

Sta-Kon®

**Thomas & Betts**



**Stock Thickness:**  
 RA & RB = .03  
 RC = .04

**Note:**  
 22-18 ga. = 1-2 Navy  
 16-14 ga. = 2½-4 Navy  
 12-10 ga. = 6-9 Navy

**Most standard bulk catalog numbers can be put on Mylar Tape for reel fed applications (i.e. 12050 tool and application dies). See pages K61- K62. Please put the suffix M for Mylar Tape RA2573M. (Bulk number 1000 and 500 packages.)**

### Nylon Insulated Rectangular Rings

Cat. No.	Stud Size	Wire Range	Dimensions				Bu-Ships Tongue Shape
			A	B	C	M	
<b>Series RA</b>							
RA486	#4	22-18	.796	.237	.237	.143	L86P-1
RA485	#4	22-18	1.015	.237	.404	.195	L85P-1
RA483	#5	22-18	.859	.277	.277	.143	L83P-1
RA484	#6	22-18	1.015	.237	.404	.195	L84P-1
RA481	#6	22-18	1.109	.302	.465	.227	L81P-1
RA482	#8	22-18	1.109	.302	.465	.227	L82P-1
RA480**	#8	22-18	1.359	.390	.621	.310	L80P-1
<b>Series RB</b>							
RB486	#4	16-14	.796	.237	.237	.143	L86P-2
RB485	#4	16-14	1.015	.237	.404	.195	L85P-2
RB483	#5	16-14	.859	.277	.277	.143	L83P-2
RB484	#6	16-14	1.015	.237	.404	.195	L84P-2
RB481	#6	16-14	1.109	.302	.465	.227	L81P-2
RB482	#8	16-14	1.109	.302	.465	.227	L82P-2
RB480**	#8	16-14	1.359	.390	.621	.310	L80P-2
<b>Series RC</b>							
RC486	#4	12-10	.984	.237	.237	.143	L86P-3
RC485	#4	12-10	1.187	.237	.404	.195	L85P-3
RC483	#5	12-10	1.046	.277	.277	.143	L83P-3
RC484	#6	12-10	1.203	.237	.404	.195	L84P-3
RC481	#6	12-10	1.281	.302	.465	.227	L81P-3
RC482	#8	12-10	1.281	.302	.465	.227	L82P-3
RC480**	#8	12-10	1.531	.390	.621	.310	L80P-3

\*\* Not available on tape.

Note: RA, RB, RC486 for use with BU-Ships terminal board types 26TB. RA, RB, RC485 for use with 25TB and 27TB. RA, RB, RC483 for use with 8TB. RA, RB, RC484 for use with 10TB and 11TB. RA, RB, RC481 for use with 6TB, 7TB and 9TB. RA, RB, RC482 for use with 15TB. RA, RB, RC480 for use with 3TB, 4TB, 5TB, 16TB, 17TB and 18TB.

Note: When ordering terminals on tape add the suffix **M**, example: (RA250M), to the catalog number.

U.L. Listed E9809

Installing tools: ERG2001, WT145C

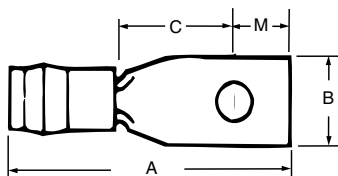

# Sta-Kon®

## Terminals



**Stock Thickness:**  
**A & B = .03**  
**C = .04**

**Note:**  
**22-18 ga. = 1-2 Navy**  
**16-14 ga. = 2½-4 Navy**  
**12-10 ga. = 6-9 Navy**

**Most standard bulk catalog numbers can be put on Mylar Tape for reel fed applications (i.e. 12050 tool and application dies). See pages K61- K62. Please put the suffix M for Mylar Tape RA2573M. (Bulk number 1000 and 500 packages.)**

### Non-Insulated Rectangular Rings

Cat. No.	Stud Size	Wire Range	Dimensions				Bu-Ships Tongue Shape
			A	B	C	M	
<b>Series A</b>							
A486	#4	22-18	.65	.237	.237	.143	L86
A485	#4	22-18	.87	.237	.404	.195	L85
A483	#5	22-18	.70	.277	.277	.143	L83
A484	#6	22-18	.87	.237	.404	.195	L84
A481	#6	22-18	.96	.302	.465	.227	L81
A482	#8	22-18	.96	.302	.465	.227	L82
A480**	#8	22-18	1.21	.390	.621	.310	L80
<b>Series B</b>							
B486	#4	16-14	.65	.237	.237	.143	L86
B485	#4	16-14	.87	.237	.404	.195	L85
B483	#5	16-14	.70	.277	.277	.143	L83
B484	#6	16-14	.87	.237	.404	.195	L84
B481	#6	16-14	.96	.302	.465	.227	L81
B482	#8	16-14	.96	.302	.465	.227	L82
B480**	#8	16-14	1.21	.390	.621	.310	L80
<b>Series C</b>							
C486	#4	12-10	.73	.237	.237	.143	L86
C485	#4	12-10	.90	.237	.404	.195	L85
C483	#5	12-10	.76	.277	.277	.143	L83
C484	#6	12-10	.94	.237	.404	.195	L84
C481	#6	12-10	1.03	.302	.465	.227	L81
C482	#8	12-10	1.03	.302	.465	.227	L82
C480**	#8	12-10	1.27	.390	.621	.310	L80

\*\* Not available on tape.

Note: A, B, C486 for use with Bu-Ships terminal board types 26TB, A, B, C485 for use with 25TB, 27TB, A, B, C483 for use with 8TB, A, B, C484 for use with 10TB and 11TB, A, B, C481 for use with 6TB, 7TB and 9TB, A, B, C482 for use with 15TB, A, B, C480 for use with 3TB, 5TB, 16TB, 17TB and 18TB.

Note: When ordering terminals on tape add the suffix **M**, example: (RA250M), to the catalog number.

U.L. Listed E9809

Installing tool: ERG 2002

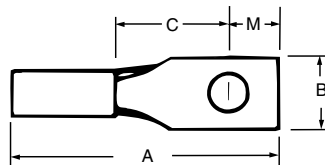

**K**

Sta-Kon®

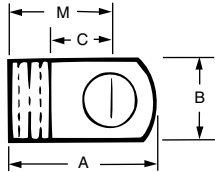
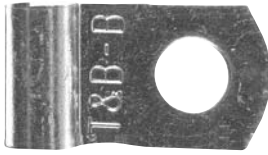

Flag terminals allow a 90° connection to the terminal block without bending the wire.

**Stock Thickness:**

- AB = .03
- C = .04
- D = .06
- E = .06
- F = .07
- G = .08

### Non-Insulated Flag

Cat. No.	Pkg. Qty.	Wire Range	Bolt Hole	Wt./Lbs. Per 1000	Dimensions			
					A	B	C	M
AB14-6A	100	22-14	#6	2½	.55	.31	.22	.39
AB51	1000	22-14	#6	2½	.55	.31	.22	.39
AB14-8A	100	22-14	#8	2½	.55	.31	.22	.39
AB52	1000	22-14	#8	2½	.55	.31	.22	.39
AB14-10A	100	22-14	#10	2½	.55	.31	.22	.39
AB53	1000	22-14	#10	2½	.55	.31	.22	.39
C51	1000	12-10	#6	5	.66	.31	.25	.48
C10-8A	50	12-10	#8	5	.66	.31	.25	.48
C52	500	12-10	#8	5	.66	.31	.25	.48
C10-10A	50	12-10	#10	5	.66	.31	.25	.48
C53	500	12-10	#10	5	.66	.31	.25	.48
D236	1000	9,8,7	#10	—	.83	.50	.25	.59
D226	1000	9,8,7	#10	—	.88	.50	.29	.64
D271	1000	9,8,7	¼"	—	.92	.50	.33	.68
E226	1000	6,5	#10	—	.93	.50	.29	.69
E271	1000	6,5	¼"	—	.97	.50	.33	.73
E272	1000	6,5	5/16"	—	1.05	.50	.41	.81
F226	1000	4,3	#10	—	1.07	.56	.33	.80
F271	1000	4,3	¼"	—	1.10	.63	.33	.80
F272	1000	4,3	5/16"	—	1.18	.63	.41	.88
F273	1000	4,3	3/8"	—	1.20	.63	.43	.90
G671	1000	2	¼"	—	1.20	.63	.33	.89
G672	1000	2	5/16"	—	1.28	.63	.41	.97
G673	1000	2	3/8"	—	1.32	.63	.46	1.02

U.L. Listed E9809

Installing tools: ERG-2004

Note: Not available on Mylar Tape.

**K**

Sta-Kon®

# Sta-Kon®

## Terminals



Fork terminals with nylon insulation sleeves, recommended for temperatures up to 105°C. Inner bronze insulation grip sleeve lengthens flex radius of conductor and eliminates conductor creep. Nylon jacket is color-coded.

Stock thickness same as ring terminal of same size.

Most standard bulk catalog numbers can be put on Mylar Tape for reel fed applications (i.e. 12050 tool and application dies). See pages K61- K62. Please put the suffix M for Mylar Tape RA2573M. (Bulk number 1000 and 500 packages.)

### Nylon Insulated Fork – Insulation Grip

Cat. No.	Pkg. Qty.	Wire Range	Max. Ins.	Bolt Hole	Wt./Lbs. Per 1000	Dimensions			
						A	B	C	M
RA18-6F	100	22-16	.136	#6	3	.83	.25	.25	.71
RA1103	1000	22-16	.136	#6	3	.83	.25	.25	.71
RA18-8F	100	22-16	.136	#8	3	.86	.31	.25	.71
RA1123	1000	22-16	.136	#8	3	.86	.31	.25	.71
RA18-10F	100	22-16	.136	#10	3	.86	.31	.25	.71
RA1153	1000	22-16	.136	#10	3	.86	.31	.25	.71
RA18-14F	100	22-16	.136	1/4"	4	.95	.44	.31	.70
RA1163	1000	22-16	.136	1/4"	4	.95	.44	.31	.70
RB14-6F	100	18-14	.162	#6	3 1/2	.87	.31	.25	.71
RB1113	1000	18-14	.162	#6	3 1/2	.87	.31	.25	.71
RB14-8F	100	18-14	.162	#8	3 1/2	.87	.31	.25	.71
RB1123	1000	18-14	.162	#8	3 1/2	.87	.31	.25	.71
RB14-10F	100	18-14	.162	#10	4	.87	.38	.25	.71
RB1153	1000	18-14	.162	#10	4	.87	.38	.25	.71
RB14-14F	100	18-14	.162	1/4"	4	.95	.44	.28	.74
RB1163	1000	18-14	.162	1/4"	4	.95	.44	.28	.74
RB1103	1000	18-14	.162	#6	6	.74	.28	.16	.60
RB1124	1000	18-14	.190	#8	6	.95	.31	.25	.79
RB1154	1000	18-14	.190	#10	6	.95	.31	.25	.79
RC10-6F	50	12-10	.210	#6	6	.97	.31	.27	.81
RC1113	500	12-10	.210	#6	6	.97	.31	.27	.81
RC10-8F	50	12-10	.210	#8	6	1.00	.37	.27	.81
RC1123	500	12-10	.210	#8	6	1.00	.37	.27	.81
RC10-10F	50	12-10	.210	#10	6	1.00	.37	.27	.81
RC1153	500	12-10	.210	#10	6	1.00	.37	.27	.81
RC10-14F	50	12-10	.210	1/4"	6	1.12	.50	.27	.86
RC1163	500	12-10	.210	1/4"	6	1.12	.50	.27	.86
RC1124	1000	12-10	.250	#8	6	1.10	.37	.27	.91
RC1154	1000	12-10	.250	#10	6	1.10	.37	.27	.91

U.L. Listed E9809

Installing tools: WT145C, WT2000, WT112M, ERG-2001, ERG-2003, WT145A

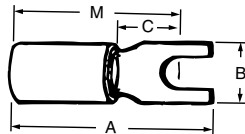

K  
Sta-Kon®



Fork terminals allow easy installation because screw needs only to be loosened. Suffix S indicates a flanged-tongue fork with turned up tips for extra holding protection.

Stock thickness same as ring terminal of same size.

Most standard bulk catalog numbers can be put on Mylar Tape for reel fed applications (i.e. 12050 tool and application dies). See pages K61-K62.

Please put the suffix M for Mylar Tape RA2573M. (Bulk number 1000 and 500 packages.)

### Nylon Insulated Fork Flanged Tongue – Insulation Grip

Cat. No.	Pkg. Qty.	Wire Range	Max. Ins.	Bolt Hole	Wt./Lbs. Per 1000	Dimensions			
						A	B	C	M
RA18-6FS	100	22-16	.136	#6	3	.75	.28	.16	.62
RA1203	1000	22-16	.136	#6	3	.75	.28	.16	.62
RA18-8FS	100	22-16	.136	#8	3	.89	.31	.23	.65
RA1223	1000	22-16	.136	#8	3	.89	.31	.23	.65
RA18-10FS	100	22-16	.136	#10	3	.93	.38	.26	.68
RA1253	1000	22-16	.136	#10	3	.93	.38	.26	.68
RB14-6FS	100	18-14	.162	#6	4	.74	.28	.16	.60
RB1203	1000	18-14	.162	#6	4	.74	.28	.16	.60
RB14-8FS	100	18-14	.162	#8	4	.89	.31	.23	.66
RB1223	1000	18-14	.162	#8	4	.89	.31	.23	.66
RB14-10FS	100	18-14	.162	#10	4	.94	.38	.27	.69
RB1253	1000	18-14	.162	#10	4	.94	.38	.27	.69
RB1204	1000	18-14	.190	#6	4	.79	.28	.16	.67
RB1224	1000	18-14	.190	#8	4	.94	.31	.23	.71
RC10-8FS	50	12-10	.210	#8	5	.97	.34	.23	.73
RC1223	500	12-10	.210	#8	5	.97	.34	.23	.73
RC10-10FS	50	12-10	.210	#10	5	1.00	.38	.26	.74
RC1253	500	12-10	.210	#10	5	1.00	.38	.26	.74
RC1224	1000	12-10	.250	#8	5	1.08	.34	.23	.80
RC1254	1000	12-10	.250	#10	5	1.12	.38	.26	.86

U.L. Listed E9809

Installing tools: WT145C, WT2000, WT112M, ERG-2001, ERG-2003, WT145A

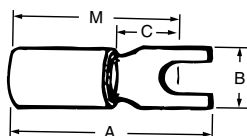

K

Sta-Kon®



# Sta-Kon® Terminals



These fork terminals have extra-long PVC insulation sleeve for protection and stress relief at wire's flex point. Brazed seam barrel is serrated for high pull-out value. Terminal is high conductivity electrolytic copper, electro-tin plated. Insulation is color-coded.

Stock thickness same as ring terminal of same size.

Most standard bulk catalog numbers can be put on Mylar Tape for reel fed applications (i.e. 12050 tool and application dies). See pages K61- K62. Please put the suffix M for Mylar Tape RA2573M. (Bulk number 1000 and 500 packages.)

## Vinyl Insulated Fork – Insulation Support

Cat. No.	Pkg. Qty.	Wire Range	Max. Ins.	Bolt Hole	Wt./Lbs. Per 1000	Dimensions			
						A	B	C	M
18RA-6F	100	22-16	.150	#6	5	.94	.25	.27	.81
RA1167	1000	22-16	.150	#6	5	.94	.25	.27	.81
18RA-8F	100	22-16	.150	#8	5	.97	.31	.27	.81
RA1147	1000	22-16	.150	#8	5	.97	.31	.27	.81
18RA-10F	100	22-16	.150	#10	5	.97	.31	.27	.81
RA1157	1000	22-16	.150	#10	5	.97	.31	.27	.81
14RB-6F	100	18-14	.170	#6	6	.97	.31	.27	.81
RB647	1000	18-14	.170	#6	6	.97	.31	.27	.81
14RB-6FS	100	18-14	.170	#6	6	.89	.30	.25	.75
14RB-8F	100	18-14	.170	#8	6	.97	.31	.27	.81
RB657	1000	18-14	.170	#8	6	.97	.31	.27	.81
14RB-10F	100	18-14	.170	#10	6	.97	.31	.27	.81
RB1157	1000	18-14	.170	#10	6	.97	.31	.27	.81
14RB-14F	100	18-14	.170	1/4"	6	1.11	.44	.38	.89
RB1717	1000	18-14	.170	1/4"	6	1.11	.44	.38	.89
10RC-6F	50	12-10	.210	#6	7	1.09	.38	.27	.90
RC1337	500	12-10	.210	#6	7	1.09	.38	.27	.90
10RC-8F	50	12-10	.210	#8	7	1.09	.38	.27	.90
RC1147	500	12-10	.210	#8	7	1.09	.38	.27	.90
10RC-10F	50	12-10	.210	#10	7	1.09	.38	.27	.90
RC1157	500	12-10	.210	#10	7	1.09	.38	.27	.90
10RC-14F	50	12-10	.210	1/4"	7	1.15	.50	.37	.90
RC1167	500	12-10	.210	1/4"	7	1.15	.50	.37	.90

U.L. Listed E9809. Installing tools: WT145C, WT2000, WT112M, ERG-2001, ERG-2003

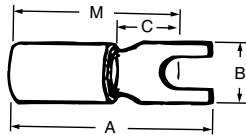

K  
Sta-Kon®



Fork terminals allow easy installation since the mounting screw does not have to be completely removed. Catalog numbers with the suffix X indicate an expanded insulation support. This means a wider wire entry to accommodate heavy wall insulation.

Stock thickness same as ring terminal of same size.

Most standard bulk catalog numbers can be put on Mylar Tape for reel fed applications (i.e. 12050 tool and application dies). See pages K61- K62. Please put the suffix M for Mylar Tape RA2573M. (Bulk number 1000 and 500 packages.)

## Vinyl Insulation Fork – Expanded Insulation Support

Cat. No.	Pkg. Qty.	Wire Range	Max. Ins.	Bolt Hole	Wt./Lbs. Per 1000	Dimensions			
						A	B	C	M
18RA-6FX	100	22-16	.170	#6	5	.94	.25	.27	.81
RA1167-170	1000	22-16	.170	#6	5	.94	.25	.27	.81
18RA-8FX	100	22-16	.170	#8	5	.97	.31	.27	.81
RA1147-170	1000	22-16	.170	#8	5	.97	.31	.27	.81
18RA-10FX	100	22-16	.170	#10	5	.97	.31	.27	.81
RA1157-170	1000	22-16	.170	#10	5	.97	.31	.27	.81
14RB-6FX	100	18-14	.200	#6	6	.97	.31	.27	.81
RB647-200	1000	18-14	.200	#6	6	.97	.31	.27	.81
14RB-8FX	100	18-14	.200	#8	6	.97	.31	.27	.81
RB657-200	1000	18-14	.200	#8	6	.97	.31	.27	.81
14RB-10FX	100	18-14	.200	#10	6	.97	.31	.27	.81
RB1157-200	1000	18-14	.200	#10	6	.97	.31	.27	.81
10RC-8FX	50	12-10	.250	#8	7	1.11	.38	.27	.90
RC1147-250	500	12-10	.250	#8	7	1.11	.38	.27	.90
10RC-10FX	50	12-10	.250	#10	7	1.11	.38	.27	.90
RC1157-250	500	12-10	.250	#10	7	1.11	.38	.27	.90
10RC-14FX	50	12-10	.250	1/4"	7	1.17	.50	.37	.90

U.L. Listed E9809. Installing tools: WT145C, WT2000, WT112M, ERG2001, ERG2003

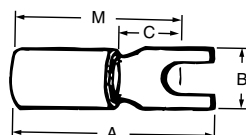

Thomas & Betts

# Sta-Kon®

## Terminals



These non-insulated fork terminals are made of electrolytic copper for high conductivity. They can be installed with crimping tools having a single indenter or double indenter (recommended for solid wire). Serrated barrel increase grip on wire. Wire range identification is stamped on the tongue of each terminal.

Stock thickness same as ring terminal of same size.

Most standard bulk catalog numbers can be put on Mylar Tape for reel fed applications (i.e. 12050 tool and application dies). See pages K61- K62. Please put the suffix M for Mylar Tape RA2573M. (Bulk number 1000 and 500 packages.)

### Non-Insulated Fork

Cat. No.	Pkg. Qty.	Wire Range	Bolt Hole	Wt./Lbs. Per 1000	Dimensions			
					A	B	C	M
A18-6F	100	22-16	#6	4	.72	.25	.27	.59
A116	1000	22-16	#6	4	.72	.25	.27	.59
A18-8F	100	22-16	#8	4	.75	.31	.27	.59
A114	1000	22-16	#8	4	.75	.31	.27	.59
A18-10F	100	22-16	#10	4	.75	.31	.27	.59
A115	1000	22-16	#10	4	.75	.31	.27	.59
B14-6F	100	18-14	#6	6	.75	.31	.27	.59
B64	1000	18-14	#6	6	.75	.31	.27	.59
B19†	1000	18-14	#6	6	.66	.25	.13	.50
B14-8F	100	18-14	#8	6	.75	.31	.27	.59
B65	1000	18-14	#8	6	.75	.31	.27	.59
B14-10F	100	18-14	#10	6	.75	.31	.27	.59
B115	1000	18-14	#10	6	.75	.31	.27	.59
B14-14F	100	18-14	¼"	6	.90	.44	.38	.68
C10-6F	50	12-10	#6	7	.77	.31	.27	.63
C133	500	12-10	#6	7	.77	.31	.27	.63
C10-8F	50	12-10	#8	7	.82	.38	.27	.63
C114	500	12-10	#8	7	.82	.38	.27	.63
C10-10F	50	12-10	#10	7	.82	.38	.27	.63
C115	500	12-10	#10	7	.82	.38	.27	.63
C10-14F	50	12-10	¼"	7	.98	.50	.37	.73
C116	500	12-10	¼"	7	.98	.50	.37	.73

U.L. Listed E9809

Installing tools: WT111M, WT112M, WT110M, WT2000, ERG-2002

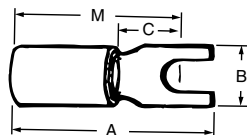

K

Sta-Kon®

Thomas & Betts

# Sta-Kon®

## Terminals

Locking fork terminals have a specially designed tongue that lets them go on like a fork and stay on like a ring.



Stock thickness same as ring terminal of same size.

Most standard bulk catalog numbers can be put on Mylar Tape for reel fed applications (i.e. 12050 tool and application dies). See pages K61- K62. Please put the suffix M for Mylar Tape RA2573M. (Bulk number 1000 and 500 packages.)

### Nylon Insulated Locking Fork – Insulation Grip

Cat. No.	Pkg. Qty.	Wire Range	Max. Ins.	Bolt Hole	Wt./Lbs. Per 1000	Dimensions			
						A	B	C	M
RA18-6FL	100	22-16	.136	#6	5	.86	.25	.25	.71
RA2213	1000	22-16	.136	#6	5	.86	.25	.25	.71
RA18-8FL	100	22-16	.136	#8	5	.86	.29	.25	.71
RA2243	1000	22-16	.136	#8	5	.86	.29	.25	.71
RA18-10FL	100	22-16	.136	#10	5	.86	.29	.25	.71
RA2253	1000	22-16	.136	#10	5	.86	.29	.25	.71
RB14-6FL	100	18-14	.162	#6	6	.87	.25	.25	.71
RB2213	1000	18-14	.162	#6	6	.87	.25	.25	.71
RB2214	1000	18-14	.190	#6	6	.95	.25	.25	.79
RB14-8FL	100	18-14	.162	#8	6	.87	.29	.25	.71
RB2233	1000	18-14	.162	#8	6	.87	.29	.25	.71
RB14-10FL	100	18-14	.162	#10	6	.87	.29	.25	.71
RB2253	1000	18-14	.162	#10	6	.87	.29	.25	.71
RB2254	1000		.190	#10	6	.95	.29	.25	.71
RC10-6FL	50	12-10	.210	#6	8	.97	.31	.27	.81
RC2203	500	12-10	.210	#6	8	.97	.31	.27	.81
RC2204	1000	12-10	.250	#6	8	1.07	.31	.27	.91
RC10-8FL	50	12-10	.210	#8	8	1.00	.37	.27	.81
RC2213	500	12-10	.210	#8	8	1.00	.37	.27	.81
RC10-10FL	50	12-10	.210	#10	8	1.00	.37	.27	.81
RC2223	500	12-10	.210	#10	8	1.00	.37	.27	.81
RC2224	1000	12-10	.250	#10		1.10	.37	.27	.91
RC10-14FL	50	12-10	.210	1/4"	8	1.12	.50	.32	.86
RC2233	500	12-10	.210	1/4"	8	1.12	.50	.32	.86

U.L. Listed E9809

Installing tools: ERG-2001, ERG-2003, WT145C, WT2000, WT112M, WT145A

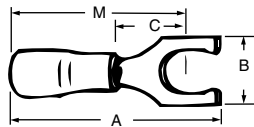

K

Sta-Kon®



Stock thickness same as ring terminal of same size.

Most standard bulk catalog numbers can be put on Mylar Tape for reel fed applications (i.e. 12050 tool and application dies). See pages K61- K62. Please put the suffix M for Mylar Tape RA2573M. (Bulk number 1000 and 500 packages.)

### Vinyl Insulated Locking Fork – Insulation Support

Cat. No.	Pkg. Qty.	Wire Range	Max. Ins.	Bolt Hole	Wt./Lbs. Per 1000	Dimensions			
						A	B	C	M
18RA-6FL	100	22-16	.150	#6	5	.97	.25	.25	.81
RA2217	1000	22-16	.150	#6	5	.97	.25	.25	.81
RA2227	1000	22-16	.155	#6	5	.97	.29	–	.81
18RA-8FL	100	22-16	.150	#8	5	.97	.29	.25	.81
RA2247	1000	22-16	.150	#8	5	.97	.29	.25	.81
18RA-10FL	100	22-16	.150	#10	5	.97	.29	.25	.81
RA2257	1000	22-16	.150	#10	5	.97	.29	.25	.81
14RB-6FL	100	18-14	.170	#6	6	.97	.25	.27	.81
RB2207	1000	18-14	.170	#6	6	.97	.25	.27	.81
RB2217	1000	18-14	.170	#6	6	.97	.29	.27	.81
14RB-8FL	100	18-14	.170	#8	6	.97	.29	.27	.81
RB2237	1000	18-14	.170	#8	6	.97	.29	.27	.81
14RB-10FL	100	18-14	.170	#10	6	.97	.29	.27	.81
RB2257	1000	18-14	.170	#10	6	.97	.29	.27	.81
10RC-6FL	50	12-10	.220	#6	8	1.09	.31	.27	.90
RC2207	500	12-10	.220	#6	8	1.09	.31	.27	.90
10RC-8FL	50	12-10	.220	#8	8	1.09	.37	.27	.90
RC2217	500	12-10	.220	#8	8	1.09	.37	.27	.90
10RC-10FL	50	12-10	.220	#10	8	1.09	.37	.27	.90
RC2227	500	12-10	.220	#10	8	1.09	.37	.27	.90
10RC-14FL	50	12-10	.220	1/4"	8	1.09	.49	.27	.90
RC2237	500	12-10	.220	1/4"	8	1.09	.49	.27	.90

U.L. Listed E9809. Installing tools: ERG-2001, ERG-2003, WT145C, WT2000, WT112M

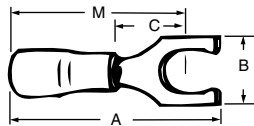

K

Sta-Kon®



Stock thickness same as ring terminal of same size.

Most standard bulk catalog numbers can be put on Mylar Tape for reel fed applications (i.e. 12050 tool and application dies). See pages K61- K62. Please put the suffix M for Mylar Tape RA2573M. (Bulk number 1000 and 500 packages.)

### Vinyl Insulated Locking Fork – Expanded Insulation Support

Cat. No.	Pkg. Qty.	Wire Range	Max. Ins.	Bolt Hole	Wt./Lbs. Per 1000	Dimensions			
						A	B	C	M
18RA-6FLX	100	22-16	.170	#6	5	.97	.25	.25	.81
18RA-8FLX	100	22-16	.170	#8	5	.97	.29	.25	.81
18RA-10FLX	100	22-16	.170	#10	5	.97	.29	.25	.81
RA2257-170	1000	22-16	.170	#10	5	.97	.29	.25	.81
14RB-6FLX	100	18-14	.200	#6	6	.97	.31	.27	.81
RB2207-200	1000	18-14	.200	#6	6	.97	.31	.27	.81
RB2217-200	1000	18-14	.200	#6	6	.97	.29	.27	.81
14RB-8FLX	100	18-14	.200	#8	6	.97	.31	.27	.81
RB2237-200	1000	18-14	.200	#8	6	.97	.31	.27	.81
14RB-10FLX	100	18-14	.200	#10	6	.97	.31	.27	.81
RB2257-200	1000	18-14	.200	#10	6	.97	.31	.27	.81
10RC-6FLX	50	12-10	.250	#6	8	1.07	.31	.27	.91
RC2207-250	500	12-10	.250	#6	8	1.07	.31	.27	.91
10RC-8FLX	50	12-10	.250	#8	8	1.10	.37	.27	.91
RC2227-250	500	12-10	.250	#8	8	1.10	.37	.27	.91
10RC-10FLX	50	12-10	.250	#10	8	1.10	.37	.27	.91
RC2227-250	500	12-10	.250	#10	8	1.10	.37	.27	.91
10RC-14FLX	50	12-10	.250	1/4"	8	1.22	.50	.32	.96

U.L. Listed E9809. Installing tools: ERG-2001, ERG-2003, WT145C, WT2000, WT112M

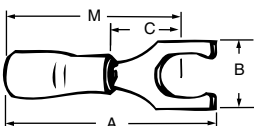



## Heat Shrinkable Locking Fork Terminals – Expanded Insulation Support

Cat. No.	Pkg. Qty.	Wire Range	Max. Ins.	Bolt Hole	Wt./Lbs. Per 1000	Dimensions	
						A	B
RAS18-6FLX	100	22-18	.170	#6	5	1.350	.25
RAS18-8FLX	100	22-18	.170	#8	5	1.350	.29
RAS18-10FLX	100	22-18	.170	#10	5	1.350	.29
RBS14-6FLX	100	16-14	.200	#6	6	1.350	.25
RBS14-8FLX	100	16-14	.200	#8	6	1.350	.29
RBS14-10FLX	100	16-14	.200	#10	6	1.350	.29
RCS10-6FLX	50	12-10	.250	#6	8	1.350	.31
RCS10-8FLX	50	12-10	.250	#8	8	1.350	.37
RCS10-10FLX	50	12-10	.250	#10	8	1.350	.37
RCS10-14FLX	50	12-10	.250	¼"	8	1.350	.49

U.L. Listed E9809

Installing tool: WT1255

Note: Heat Shrinkable terminals not available on Mylar Tape.

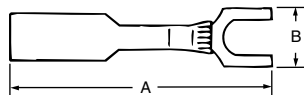

Stock thickness same as ring terminal of same size.

Most standard bulk catalog numbers can be put on Mylar Tape for reel fed applications (i.e. 12050 tool and application dies). See pages K61- K62. Please put the suffix M for Mylar Tape RA2573M. (Bulk number 1000 and 500 packages.)

## Non-Insulated Locking Fork

Cat. No.	Pkg. Qty.	Wire Range	Bolt Hole	Wt./Lbs. Per 1000	Dimensions			
					A	B	C	M
A18-6FL	100	22-16	#6	4¾	.75	.25	.27	.59
A221	1000	22-16	#6	4¾	.75	.25	.27	.59
A18-8FL	100	22-16	#8	4¾	.75	.29	.27	.59
A224	1000	22-16	#8	4¾	.75	.29	.27	.59
A18-10FL	100	22-16	#10	4¾	.75	.29	.27	.59
A225	1000	22-16	#10	4¾	.75	.29	.27	.59
B14-6FL	100	18-14	#6	4¾	.75	.25	.27	.59
B220	1000	18-14	#6	4¾	.75	.25	.27	.59
B14-8FL	100	18-14	#8	4¾	.75	.29	.27	.59
B223	1000	18-14	#8	4¾	.75	.29	.27	.59
B14-10FL	100	18-14	#10	4¾	.75	.29	.27	.59
B225	1000	18-14	#10	4¾	.75	.29	.27	.59
C10-6FL	50	12-10	#6	7¾	.85	.31	.27	.66
C220	500	12-10	#6	7¾	.85	.31	.27	.66
C10-8FL	50	12-10	#8	7¾	.85	.37	.27	.66
C221	500	12-10	#8	7¾	.85	.37	.27	.66
C10-10FL	50	12-10	#10	7¾	.85	.37	.27	.66
C222	500	12-10	#10	7¾	.85	.37	.27	.66
C10-14FL	50	12-10	¼"	7¾	.85	.49	.27	.66

U.L. Listed E9809

Installing tools: WT110M, WT111M, WT112M, WT2000, ERG-2002

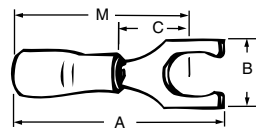

K  
Sta-Kon®

# Sta-Kon®

## Terminals

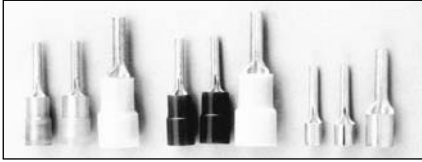

- Provides an easy and effective way to terminate stranded wire into European/metric-style terminal blocks.
- Designed to prevent shorting, wire strand loss and/or wire pullout resulting from improper termination of stranded wire.
- Designed to meet emerging global standards which require wire-to-metric style terminal block installations be terminated with a "pin" style terminal.
- Available in vinyl insulated, nylon insulated, and non-insulated styles.
- All styles offered in 22 AWG to 10 AWG and compatible with existing Sta-Kon® tooling.

### Voltage Rating

Vinyl – 600V  
Nylon – 300V

## Pin Terminals

### Nylon Insulated Terminals

Cat. No.	Pkg. Qty.	Wire Range	D (Dia.)	L	Recommended Tools
<b>Non-Insulated</b>					
A47PT	1000	22-18	.075	.63	WT111M
B47PT	1000	16-14	.075	.63	ERG-2002
C55PT	500	12-10	.110	.76	
<b>Vinyl</b>					
18RA-47PT	100	22-18	.075	.85	ERG-2003
RA47PT	1000	22-18	.075	.85	
14RB-47PT	100	16-14	.075	.87	
RB47PT	1000	16-14	.075	.87	
10RC-55PT	50	12-10	.110	1.06	
RC55PT	500	12-10	.106	1.06	ERG-2001
<b>Nylon</b>					
RA18-47PT	100	22-18	.075	.85	ERG-2003
RA147PT	1000	22-18	.075	.85	WT2000
RB14-47PT	100	16-14	.075	.87	
RB147PT	1000	16-14	.075	.87	
RC10-55PT	50	12-10	.110	1.06	
RC155PT	500	12-10	.106	1.06	ERG-2001

Most standard bulk catalog numbers can be put on Mylar Tape for reel fed applications (i.e. 12050 tool and application dies). See pages K61- K62.

Please put the suffix M for Mylar Tape RA2573M. (Bulk number 1000 and 500 packages.)

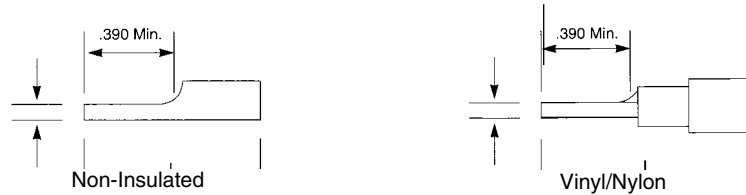

K

Sta-Kon®

**Thomas & Betts**

# Sta-Kon® Insulated Ferrules

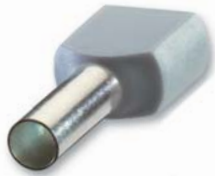

## Features

- Ferrules ensure reliable electrical connections when terminating conductors in screw clamp terminal blocks.
- Fraying and breaking of wire strands is prevented and the possibility of an unreliable connection is minimized.
- Insulated ferrules prevent conductor breakage due to bending, wire stress or vibration, while facilitating wire insertions into the terminal block clamp.
- Ferrules are the preferred alternative to twisting wire stands or tinning the wire end before terminating into a terminal block.
- Ferrules are thin-walled copper tubes, which are mechanically crimped onto the ends of stranded wires.
- They are easy to use – simply strip the wire, slide the ferrule onto the end of the wire and crimp.

## How to Apply a Ferrule

- Strip the insulation from the end of the wire and insert into the insulated end of the ferrule.
- Using the designated crimping tool, place the metal shaft into the tool's appropriate slot. Compress the tool to make a crescent-shape depression along the length of the ferrule.
- Insert the crimped ferrule into the terminal block.
- Tighten the ferrule and wire into the terminal block.

## Materials

- High conductivity copper
- Tin plating



## Insulated Ferrules

Cat. No.	Conductor Section		Color	Dimensions Inches/MM					Installation Tooling	Bag Pkg. Qty.	Case Pkg. Qty.
	AWG	MM²		A	B	øC	øD	E			
F2020	22	0.50	WHITE	.453 / 11.5	.236 / 6.0	.043 / 1.1	.098 / 2.5	.006 / 0.15	T1, T3 & ERG-2	500	5000
F2021	22	0.50	WHITE	.531 / 13.5	.315 / 8.0	.043 / 1.1	.098 / 2.5	.006 / 0.15	T1, T3 & ERG-2	500	10000
F2022	22	0.50	WHITE	.610 / 15.5	.394 / 10.0	.043 / 1.1	.098 / 2.5	.006 / 0.15	T1, T3 & ERG-2	500	5000
F2023	20	0.75	GREY	.472 / 12.0	.236 / 6.0	.051 / 1.3	.110 / 2.8	.006 / 0.15	T1, T3 & ERG-2	500	5000
F2024	20	0.75	GREY	.551 / 14.0	.315 / 8.0	.051 / 1.3	.110 / 2.8	.006 / 0.15	T1, T3 & ERG-2	500	10000
F2025	20	0.75	GREY	.630 / 16.0	.394 / 10.0	.051 / 1.3	.110 / 2.8	.006 / 0.15	T1, T3 & ERG-2	500	5000
F2026	20	0.75	GREY	.709 / 18.0	.472 / 12.0	.051 / 1.3	.110 / 2.8	.006 / 0.15	T1, T3 & ERG-2	500	5000
F2027	20	1.00	RED	.492 / 12.5	.236 / 6.0	.059 / 1.5	.118 / 3.0	.006 / 0.15	T1, T3 & ERG-2	500	5000
F2028	20	1.00	RED	.571 / 14.5	.315 / 8.0	.059 / 1.5	.118 / 3.0	.006 / 0.15	T1, T3 & ERG-2	500	10000
F2029	20	1.00	RED	.650 / 16.5	.394 / 10.0	.059 / 1.5	.118 / 3.0	.006 / 0.15	T1, T3 & ERG-2	500	5000
F2030	20	1.00	RED	.728 / 18.5	.472 / 12.0	.059 / 1.5	.118 / 3.0	.006 / 0.15	T1, T3 & ERG-2	500	5000
F2031	16	1.50	BLACK	.571 / 14.5	.315 / 8.0	.071 / 1.8	.134 / 3.4	.006 / 0.15	T1, T3 & ERG-2	500	10000
F2032	16	1.50	BLACK	.650 / 16.5	.394 / 10.0	.071 / 1.8	.134 / 3.4	.006 / 0.15	T1, T3 & ERG-2	500	5000
F2033	16	1.50	BLACK	.728 / 18.5	.472 / 12.0	.071 / 1.8	.134 / 3.4	.006 / 0.15	T1, T3 & ERG-2	500	5000
F2034	16	1.50	BLACK	.965 / 24.5	.708 / 18.0	.071 / 1.8	.134 / 3.4	.006 / 0.15	T1, T3 & ERG-2	500	5000
F2035	14	2.50	BLUE	.591 / 15.0	.315 / 8.0	.091 / 2.3	.165 / 4.2	.006 / 0.15	T1, T3 & ERG-2	500	10000
F2036	14	2.50	BLUE	.748 / 19.0	.472 / 12.0	.091 / 2.3	.165 / 4.2	.006 / 0.15	T1, T3 & ERG-2	500	5000
F2037	14	2.50	BLUE	.984 / 25.0	.708 / 18.0	.091 / 2.3	.165 / 4.2	.006 / 0.15	T1, T3 & ERG-2	500	5000
F2038	12	4.00	GREY	.889 / 17.5	.394 / 10.0	.114 / 2.9	.189 / 4.8	.008 / 0.20	T3 & ERG-2	500	5000
F2039	12	4.00	GREY	.787 / 20.0	.472 / 12.0	.114 / 2.9	.189 / 4.8	.008 / 0.20	T3 & ERG-2	500	5000
F2040	12	4.00	GREY	1.024 / 26.0	.708 / 18.0	.114 / 2.9	.189 / 4.8	.008 / 0.20	T3 & ERG-2	100	1000
F2041	10	6.00	YELLOW	.787 / 20.0	.472 / 12.0	.142 / 3.6	.244 / 6.2	.008 / 0.20	T3 & ERG-2	100	1000
F2042	10	6.00	YELLOW	.984 / 25.0	.708 / 18.0	.142 / 3.6	.244 / 6.2	.008 / 0.20	T3 & ERG-2	100	1000
F2043	8	10.00	RED	.827 / 21.0	.472 / 12.0	.181 / 4.6	.295 / 7.5	.008 / 0.20	T3 & ERG-2	100	1000
F2044	8	10.00	RED	1.063 / 27.0	.708 / 18.0	.181 / 4.6	.295 / 7.5	.008 / 0.20	T3 & ERG-2	100	1000
F2045	6	16.00	BLUE	.906 / 23.0	.472 / 12.0	.236 / 6.0	.346 / 8.8	.008 / 0.20	ERG-2	100	1000
F2046	6	16.00	BLUE	1.142 / 29.0	.708 / 18.0	.236 / 6.0	.346 / 8.8	.008 / 0.20	ERG-2	50	1000
F2047	4	25.00	YELLOW	1.142 / 29.0	.630 / 16.0	.295 / 7.5	.433 / 11.0	.008 / 0.20	ERG-2	50	500
F2048	4	25.00	YELLOW	1.220 / 31.0	.708 / 18.0	.295 / 7.5	.433 / 11.0	.008 / 0.20	ERG-2	50	500
F2049	4	25.00	YELLOW	1.378 / 35.0	.866 / 22.0	.295 / 7.5	.433 / 11.0	.008 / 0.20	ERG-2	50	500
F2050	2	35.00	RED	1.181 / 30.0	.630 / 16.0	.335 / 8.5	.492 / 12.5	.008 / 0.20	ERG-2	50	500
F2051	2	35.00	RED	1.260 / 32.0	.708 / 18.0	.335 / 8.5	.492 / 12.5	.008 / 0.20	ERG-2	50	500
F2052	2	35.00	RED	1.535 / 39.0	.984 / 25.0	.335 / 8.5	.492 / 12.5	.008 / 0.20	ERG-2	50	500
F2053	1/0	50.00	BLUE	1.417 / 36.0	.787 / 20.0	.413 / 10.5	.591 / 15.0	.014 / 0.35	ERG-2	50	500
F2054	1/0	50.00	BLUE	1.614 / 41.0	.984 / 25.0	.413 / 10.5	.591 / 15.0	.014 / 0.35	ERG-2	50	500
F4004	26	0.14	Grey	.413/10.5	.236/6.0	.031/8.0	.079/2.0	.010/25	T3, ERG2	500	10,000
F4005	26	0.14	Grey	.492/12.5	.315/8.0	.031/8.0	.079/2.0	.010/25	T3, ERG2	500	10,000
F4006	24	0.25	Yellow	.413/10.5	.236/6.0	.031/8.0	.079/2.0	.010/25	T3, ERG2	500	10,000
F4007	24	0.25	Yellow	.492/12.5	.315/8.0	.031/8.0	.079/2.0	.010/25	T3, ERG2	500	10,000
F4008	22	0.34	Purple	.413/10.5	.236/6.0	.031/8.0	.079/2.0	.010/25	T3, ERG2	500	10,000
F4009	22	0.34	Purple	.492/12.5	.315/8.0	.031/8.0	.079/2.0	.010/25	T3, ERG2	500	10,000

Ferrule Dimensions conform to DIN 46228, Part 4.

**Thomas & Betts**

# Sta-Kon® Insulated Ferrules

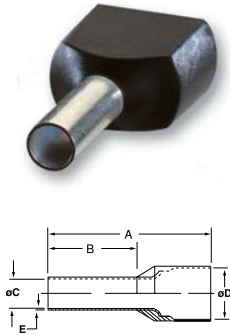

## Insulated Twin Ferrules

Cat. No.	Conductor Section		Color	Dimensions Inches/MM					Installation Tooling	Bag Pkg. Qty.	Case Pkg. Qty.
	AWG	MM²		A	B	øC	øD	E			
F8000	2x 20	2x 0.50	WHITE	.591 / 15.0	.315 / 8.0	.059 / 1.5	.177 / 4.5	.010 / 0.25	T3	500	5000
F8001	2x 18	2x 0.75	GREY	.591 / 15.0	.315 / 8.0	.071 / 1.8	.201 / 5.1	.010 / 0.25	T3	500	5000
F8002	2x 18	2x 0.75	GREY	.669 / 17.0	.394 / 10.0	.071 / 1.8	.201 / 5.1	.006 / 0.15	T3	500	5000
F8003	2x 17	2x 1.00	RED	.591 / 15.0	.315 / 8.0	.081 / 2.05	.201 / 5.1	.006 / 0.15	T3	500	5000
F8005	2x 17	2x 1.00	RED	.669 / 17.0	.394 / 10.0	.081 / 2.05	.201 / 5.1	.006 / 0.15	T3	500	5000
F8006	2x 16	2x 1.50	BLACK	.630 / 16.0	.315 / 8.0	.091 / 2.3	.252 / 6.4	.006 / 0.15	T3	500	5000
F8007	2x 16	2x 1.50	BLACK	.787 / 20.0	.472 / 12.0	.091 / 2.3	.252 / 6.4	.006 / 0.15	T3	500	5000
F8008	2x 14	2x 2.50	BLUE	.728 / 18.5	.394 / 10.0	.114 / 2.9	.295 / 7.5	.006 / 0.15	T3	500	5000
F8009	2x 14	2x 2.50	BLUE	.846 / 21.5	.512 / 13.0	.114 / 2.9	.295 / 7.5	.006 / 0.15	T3	500	5000
F8010	2x 12	2x 4.00	GREY	.906 / 23.0	.472 / 12.0	.150 / 3.8	.339 / 8.6	.006 / 0.15	ERG-2 / 6MM DIE	100	1000
F8011	2x 10	2x 6.00	YELLOW	.984 / 25.0	.551 / 14.0	.193 / 4.9	.378 / 9.6	.008 / 0.20	ERG-2 / 10MM DIE	100	1000

Ferrule Dimensions conform to DIN 46228. Part 4.

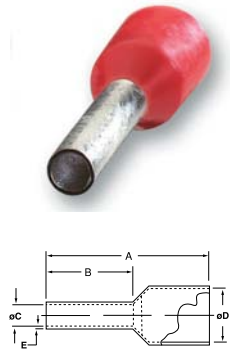

## Insulated Ferrules (Old DIN and French Standards)

Cat. No.	Style	Conductor Section		Color	Dimensions Inches/MM					Installation Tooling	Bag Pkg. Qty.	Case Pkg. Qty.
		AWG	MM²		A	B	øC	øD	E			
F4000	OLD DIN	20	0.50	ORANGE	.571 / 14.5	.315 / 8.0	.043 / 1.1	.102 / 2.6	.006 / 0.15	T1, T3 & ERG-2	500	10000
F4001	OLD DIN	18	0.75	WHITE	.571 / 14.5	.315 / 8.0	.051 / 1.3	.110 / 2.8	.006 / 0.15	T1, T3 & ERG-2	500	10000
F4002	OLD DIN	18-17	1.00	YELLOW	.571 / 14.5	.315 / 8.0	.059 / 1.5	.118 / 3.0	.006 / 0.15	T1, T3 & ERG-2	500	10000
F4003	OLD DIN	16	1.50	RED	.571 / 14.5	.315 / 8.0	.071 / 1.8	.134 / 3.4	.006 / 0.15	T1, T3 & ERG-2	500	10000
F4004		26	0.14	Grey	.413/10.5	.236/6.0	.031/8.0	.079/2.0	.010/25	T3, ERG2	500	10,000
F4005		26	0.14	Grey	.492/12.5	.315/8.0	.031/8.0	.079/2.0	.010/25	T3, ERG2	500	10,000
F4006		24	0.25	Yellow	.413/10.5	.236/6.0	.031/8.0	.079/2.0	.010/25	T3, ERG2	500	10,000
F4007		24	0.25	Yellow	.492/12.5	.315/8.0	.031/8.0	.079/2.0	.010/25	T3, ERG2	500	10,000
F4008		22	0.34	Purple	.413/10.5	.236/6.0	.031/8.0	.079/2.0	.010/25	T3, ERG2	500	10,000
F4009		22	0.34	Purple	.492/12.5	.315/8.0	.031/8.0	.079/2.0	.010/25	T3, ERG2	500	10,000
F4020	OLD DIN	14	2.50	BLUE	.571 / 14.5	.315 / 8.0	.091 / 2.3	.165 / 4.2	.006 / 0.15	T1, T3 & ERG-2	500	10000
F4021	FRENCH	20	0.50	WHITE	.571 / 14.5	.315 / 8.0	.043 / 1.1	.102 / 2.6	.006 / 0.15	T1, T3 & ERG-2	500	10000
F4023	FRENCH	18	0.75	Lt BLUE	.571 / 14.5	.315 / 8.0	.051 / 1.3	.110 / 2.8	.006 / 0.15	T1, T3 & ERG-2	500	10000
F4024	FRENCH	18-17	1.00	RED	.571 / 14.5	.315 / 8.0	.059 / 1.5	.118 / 3.0	.006 / 0.15	T1, T3 & ERG-2	500	10000
F4027	FRENCH	16	1.50	BLACK	.571 / 14.5	.315 / 8.0	.071 / 1.8	.134 / 3.4	.006 / 0.15	T1, T3 & ERG-2	500	10000
F4028	FRENCH	14	2.50	GREY	.571 / 14.5	.315 / 8.0	.091 / 2.3	.165 / 4.2	.006 / 0.15	T1, T3 & ERG-2	500	10000

Ferrule Dimensions conform to DIN 46228. Part 4.

## Tooling for Sta-Kon® Insulated Ferrules

Cat. No.	Description	Std. Pkg.
T1	Sta-Kon® Crimp tool for wire ferrules #20-14 AWG – insulated handle	1
T3	Sta-Kon® Crimp tool for wire ferrules #26-10 AWG – insulated handle	1
ERG-2	Comfort Crimp® Sta-Kon® Crimp Tool with Shure-Stake® mechanism, for installing wire ferrules #26-1 AWG. 4 interchangeable die sets included. Insulated handle. Packaged in sturdy plastic carrying case.	1

ERG3000 Dies available. See page K58.



T1



T3



ERG-2

T&B Part No.	Description
ERG2014F	ERG3000 Die for ferrules, size 20-14 AWG
ERG128F	ERG3000 Die for ferrules, size 12-8 AWG
ERG6F	ERG3000 Die for ferrules, size 6 AWG
ERG4F	ERG3000 Die for ferrules, size 4 AWG
ERG2F	ERG3000 Die for ferrules, size 2 AWG
ERG1F	ERG3000 Die for ferrules, size 1 AWG

**Thomas & Betts**



### Uninsulated Ferrule Terminals

Cat. No.	Conductor Section		Dimensions (Inches / MM)				Installation Tooling	Pkg. Qty.
	AWG	MM <sup>2</sup>	C	D	A	E		
F9000	24	.25	.030 / 0.75	.067 / 1.7	.196 / 5	.006 / 0.15	T1, ERG2	1000
F9001	22	.50	.039 / 1.0	.083 / 2.1	.236 / 6	.006 / 0.15	T1, T3, ERG2	1000
F9002	22	.50	.039 / 1.0	.083 / 2.1	.394 / 10	.006 / 0.15	T1, T3, ERG2	100
F9003	18	.75	.047 / 1.2	.091 / 2.3	.236 / 6	.006 / 0.15	T1, T3, ERG2	1000
F9004	18	.75	.047 / 1.2	.091 / 2.3	.394 / 10	.006 / 0.15	T1, T3, ERG2	1000
F9005	18	1.0	.055 / 1.4	.098 / 2.5	.236 / 6	.006 / 0.15	T1, T3, ERG2	1000
F9006	18	1.0	.055 / 1.4	.098 / 2.5	.394 / 10	.006 / 0.15	T1, T3, ERG2	1000
F9007	16	1.5	.067 / 1.7	.110 / 2.8	.276 / 7	.006 / 0.15	T1, T3, ERG2	1000
F9008	16	1.5	.067 / 1.7	.110 / 2.8	.394 / 10	.006 / 0.15	T1, T3, ERG2	1000
F9009	16	1.5	.067 / 1.7	.110 / 2.8	.473 / 12	.006 / 0.15	T1, T3, ERG2	1000
F9010	16	1.5	.067 / 1.7	.110 / 2.8	.709 / 18	.006 / 0.15	T1, T3, ERG2	1000
F9011	14	2.5	.087 / 2.2	.139 / 3.4	.276 / 7	.006 / 0.15	T1, T3, ERG2	1000
F9012	14	2.5	.087 / 2.2	.139 / 3.4	.394 / 10	.006 / 0.15	T1, T3, ERG2	1000
F9013	14	2.5	.087 / 2.2	.139 / 3.4	.472 / 12	.006 / 0.15	T1, T3, ERG2	1000
F9014	14	2.5	.087 / 2.2	.139 / 3.4	.709 / 18	.006 / 0.15	T1, T3, ERG2	1000
F9015	12	4.0	.110 / 2.8	.158 / 4	.354 / 9	.008 / 0.2	T3, ERG2	1000
F9016	12	4.0	.110 / 2.8	.158 / 4	.472 / 12	.008 / 0.2	T3, ERG2	1000
F9017	12	4.0	.110 / 2.8	.158 / 4	.591 / 15	.008 / 0.2	T3, ERG2	1000
F9018	12	4.0	.110 / 2.8	.158 / 4	.709 / 18	.008 / 0.2	T3, ERG2	1000
F9019	10	6.0	.138 / 3.5	.185 / 4.7	.472 / 12	.008 / 0.2	T3, ERG2	250
F9020	10	6.0	.138 / 3.5	.185 / 4.7	.591 / 15	.008 / 0.2	T3, ERG2	250
F9021	10	6.0	.138 / 3.5	.185 / 4.7	.709 / 18	.008 / 0.2	T3, ERG2	250
F9022	8	10.0	.177 / 4.5	.228 / 5.8	.472 / 12	.008 / 0.2	T3, ERG2	250
F9023	8	10.0	.177 / 4.5	.228 / 5.8	.591 / 15	.008 / 0.2	T3, ERG2	250
F9024	8	10.0	.177 / 4.5	.228 / 5.8	.709 / 18	.008 / 0.2	T3, ERG2	250
F9025	6	16.0	.228 / 5.8	.295 / 7.5	.472 / 12	.008 / 0.2	T3, ERG2	250
F9026	6	16.0	.228 / 5.8	.295 / 7.5	.591 / 15	.008 / 0.2	T3, ERG2	250
F9027	6	16.0	.228 / 5.8	.295 / 7.5	.709 / 18	.008 / 0.2	T3, ERG2	250
F9028	6	16.0	.228 / 5.8	.295 / 7.5	.984 / 25	.008 / 0.2	T3, ERG2	250
F9029	6	16.0	.228 / 5.8	.295 / 7.5	1.26 / 32	.008 / 0.2	T3, ERG2	250
F9030	4	25.0	.287 / 7.3	.374 / 9.5	.591 / 15	.010 / .25	ERG2	1000
F9031	4	25.0	.287 / 7.3	.374 / 9.5	.709 / 18	.010 / .25	ERG2	1000
F9032	4	25.0	.287 / 7.3	.374 / 9.5	.984 / 25	.010 / .25	ERG2	1000
F9033	4	25.0	.287 / 7.3	.374 / 9.5	1.26 / 32	.010 / .25	ERG2	1000
F9034	2	35.0	.327 / 8.3	.433 / 11	.709 / 18	.010 / .25	ERG2	100
F9035	2	35.0	.327 / 8.3	.433 / 11	.984 / 25	.010 / .25	ERG2	100
F9036	2	35.0	.327 / 8.3	.433 / 11	1.26 / 32	.010 / .25	ERG2	100
F9037	1/0	50.0	.406 / 10.3	.512 / 13	.709 / 18	.012 / 0.3	ERG2	100
F9038	1/0	50.0	.406 / 10.3	.512 / 13	.984 / 25	.012 / 0.3	ERG2	100
F9039	1/0	50.0	.406 / 10.3	.512 / 13	1.18 / 30	.012 / 0.3	ERG2	100

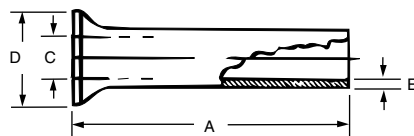



*These ring terminals are self-insulated with heat shrinkable polyolefin and internally coated sealant. Upon completed installation, a fully sealed connection is achieved to protect the joint against the degrading effects of galvanic action, corrosion, and environmental exposure.*

**RAS & RBS stock thickness: .03**  
**RCS stock thickness: .04**

**K**

Sta-Kon®



### Heat Shrinkable

These ring terminals, butt splices and disconnects are self-insulated with heat shrinkable polyolefin and internally coated sealant. Upon completed instal-

lation, a fully sealed connection is achieved to protect the joint against the degrading effects of galvanic action, corrosion, and environmental exposure.



### Heat Shrinkable Ring Terminals – Expanded Insulation Support

Cat. No.	Pkg. Qty.	Wire Range	Max. Ins.	Bolt Hole	Wt./Lbs. Per 1000	Dimensions			
						A	B	C	M
<b>RAS18-6X</b>	100	22-18	.170	#6	2	1.23	.25	.27	1.10
<b>RAS18-8X</b>	100	22-18	.170	#8	3	1.26	.31	.27	1.10
<b>RAS18-10X</b>	100	22-18	.170	#10	2	1.26	.31	.27	1.10
<b>RBS14-6X</b>	100	16-14	.200	#6	3	1.23	.25	.27	1.10
<b>RBS14-8X</b>	100	16-14	.200	#8	3	1.23	.25	.27	1.10
<b>RBS14-10X</b>	100	16-14	.200	#10	3½	1.26	.31	.27	1.10
<b>RCS10-6X</b>	50	12-10	.250	#6	3	1.34	.31	.27	1.15
<b>RCS10-8X</b>	50	12-10	.250	#8	5	1.34	.37	.27	1.15
<b>RCS10-10X</b>	50	12-10	.250	#10	5	1.34	.37	.27	1.15
<b>RCS10-14X</b>	50	12-10	.250	¼"	6	1.34	.49	.32	1.15

U.L. Listed E9809

Installing tool: WT1255

Note: Not available on Mylar Tape.

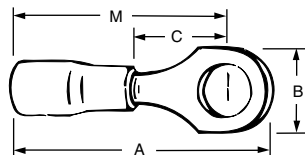

### Heat Shrinkable Locking Fork Terminals – Expanded Insulation Support

Cat. No.	Pkg. Qty.	Wire Range	Max. Ins.	Bolt Hole	Wt./Lbs. Per 1000	Dimensions	
						A	B
<b>RAS18-6FLX</b>	100	22-18	.170	#6	5	1.350	.25
<b>RAS18-8FLX</b>	100	22-18	.170	#8	5	1.350	.29
<b>RAS18-10FLX</b>	100	22-18	.170	#10	5	1.350	.29
<b>RBS14-6FLX</b>	100	16-14	.200	#6	6	1.350	.25
<b>RBS14-8FLX</b>	100	16-14	.200	#8	6	1.350	.29
<b>RBS14-10FLX</b>	100	16-14	.200	#10	6	1.350	.29
<b>RCS10-6FLX</b>	50	12-10	.250	#6	8	1.350	.31
<b>RCS10-8FLX</b>	50	12-10	.250	#8	8	1.350	.37
<b>RCS10-10FLX</b>	50	12-10	.250	#10	8	1.350	.37
<b>RCS10-14FLX</b>	50	12-10	.250	¼"	8	1.350	.49

U.L. Listed E9809

Installing tool: WT1255

Note: Heat Shrinkable terminals not available on Mylar Tape.

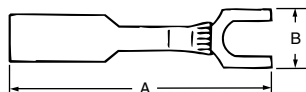



### Heat Shrinkable-Fully Insulated 250 Disconnects – Female

Cat. No.	Pkg. Qty.	Wire Range	Max. Ins.	Tab Size	Wt./Lbs. Per 1000	
					A	
RAS18-250AX	50	22-18	.170	.250 x .032	4	1.82
RBS14-250AX	50	16-14	.200	.250 x .032	5	1.77
RCS10-250AX	25	12-10	.250	.250 x .032	6	1.80

Installing tool: WT1255

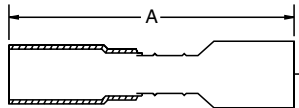

### Heat Shrinkable-Fully Insulated 250 Disconnects – Male

Cat. No.	Pkg. Qty.	Wire Range	Max. Ins.	Tab Size	Wt./Lbs. Per 1000	
					A	
18RAS-251TX	50	22-18	.170	.250 x .032	4	1.80
14RBS-251TX	100	16-14	.200	.250 x .032	5	1.75
10RCS-251TX	100	12-10	.250	.250 x .032	6	1.80

Installing tool: WT1255

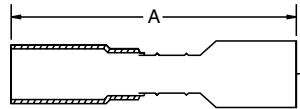

### Heat Shrinkable Splices – Butt Type – Expanded Insulation

Cat. No.	Pkg. Qty.	Wire Range	Max. Ins.	Wt./Lbs. Per 1000	A		B	
2RAS18X	50	22-18	.170	3	1.50	.25		
RAAS22X	1000	22-18	.170	3	1.50	.25		
2RBS14X	50	16-14	.200	3	1.50	.26		
RBBS22X	500	16-14	.200	3	1.50	.26		
2RCS10X	25	12-10	.250	7	1.60	.31		
RCCS22X	500	12-10	.250	7	1.60	.31		

Installing tool: WT1255

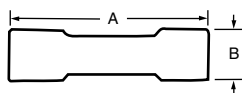

*These butt splices are self-insulated with heat shrinkable polyolefin and internally coated sealant. Upon completed installation, a fully sealed connection is achieved to protect the joint against the degrading effects of galvanic action, corrosion, and environmental exposure.*

### Butt Type Splices

In butt splices, the wires are butted together and crimped at each end of the splice. They are available either non-insulated, or insulated with nylon

or PVC. Nylon insulated splices meet or exceed the requirements of MIL-T-7928. These splices are color-coded according to wire size.



### Nylon Insulated Splices – Aircraft Systems Splices

Cat. No.	Pkg. Qty.	Wire Range	Wt./Lbs. Per 1000	Dimensions	
				A	B
2RZZ	50	26-22	2	1.22	.15
2RAA	50	22-18	6	1.52	.25
RAA23	500	22-18	6	1.52	.25
2RBB	50	16-14	6	1.52	.28
RBB23	500	16-14	6	1.52	.28
2RCC	25	12-10	8	1.53	.35
RCC23	250	12-10	8	1.53	.35

Not U.L. Listed

Installing tools: WT145C, ERG-2001, ERG-2003, WT1452(R22)

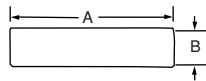

K

Sta-Kon®



### Nylon Insulated Splices – Butt Type – Insulation Support

Cat. No.	Pkg. Qty.	Max Ins. Dia.	Wire Range	Wt./Lbs. Per 1000	Dimensions	
					A	B
2RA18	100	.115	22-18	3	1.19	.18
RAA21	1000	.115	22-18	3	1.19	.18
2RB14	100	.148	16-14	3	1.19	.21
RBB21	1000	.148	16-14	3	1.19	.21
2RC10	50	.210	12-10	7	1.26	.28
RCC21	500	.210	12-10	7	1.26	.28
2RD8	25	.340	8	25	1.69	.36
RDD27	200	.340	8	25	1.69	.36
2RE6	20	.420	6	35	1.85	.45
REE28	200	.420	6	35	1.85	.45
2RF4	15	.510	4	40	1.85	.52

U.L. Listed E9809

Installing tools: ERG-2001, ERG-2003, WT145C, WT112M, TBM6/TBM6S (D-F)

Note: Not available on Mylar Tape.

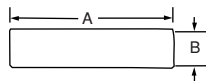

# Sta-Kon®

## Splice Connectors



### Vinyl Insulated Splices – Butt Type – Expanded Insulation

Cat. No.	Pkg. Qty.	Wire Range	Max. Ins.	Wt./Lbs. Per 1000	Dimensions	
					A	B
2RA18X	100	22-18	.155	3	1.13	.25
RAA217-170	1000	22-18	.170	3	1.13	.25
RAA217	1000	22-18	.155	3	1.13	.23
2RB14X	100	16-14		3	1.13	.26
RBB217-200	1000	16-14	.200	3	1.13	.26
RBB217	1000	16-14		3	1.13	.23
2RC10X	50	12-10	.210	7	1.31	.31
RCC217-250	500	12-10	.250	7	1.31	.31
RCC217	1000	12-10	.210	7	1.31	.29

U.L. Listed E9809

Installing tools: WT145C, WT2000, WT112M, ERG-2001, ERG-2003

Bulk No's:RAA22X– RBB22X – RCC22X



*These butt splices are self-insulated with heat shrinkable polyolefin and internally coated sealant. Upon completed installation, a fully sealed connection is achieved to protect the joint against the degrading effects of galvanic action, corrosion, and environmental exposure.*

### Heat Shrinkable Splices – Butt Type – Expanded Insulation

Cat. No.	Pkg. Qty.	Wire Range	Max. Ins.	Wt./Lbs. Per 1000	Dimensions	
					A	B
2RAS18X	50	22-18	.170	3	1.50	.25
RAAS22X	500	22-18	.170	3	1.50	.25
2RBS14X	50	16-14	.200	3	1.50	.26
RBBS22X	500	16-14	.200	3	1.50	.26
2RCS10X	25	12-10	.250	7	1.60	.31
RCCS22X	250	12-10	.250	7	1.60	.31

Installing tool: WT1255



*A, B & C bulk numbers can be put on Mylar Tape for reel fed applications (i.e. 12050 tool and application dies). See pages K61- K62. Please put the suffix M for Mylar Tape RA2573M. (Bulk number 1000 and 500 packages.)*

### Non-Insulated Splices – Butt Type

Cat. No.	Pkg. Qty.	Wire Range	Wt./Lbs. Per 1000	Dimensions	
				A	B
2A-18	100	22-18	2½	.62	.12
AA2	1000	22-18	2½	.62	.12
2B-14	100	16-14	2½	.62	.16
BB2	1000	16-14	2½	.62	.16
2C-10	50	12-10	7	.72	.22
CC2	500	12-10	7	.72	.22
2D-8	25	9-8-7	18	1.03	.28
DD102	200	9-8-7	18	1.03	.28
2E-6	20	6-5	25	1.12	.37
EE2	200	6-5	25	1.12	.37
2F-4	15	4-3	30	1.25	.44
FF2	200	4-3	30	1.25	.44
2G21	5	2-1	40	1.72	.55
GG2	25	2-1	40	1.72	.55

U.L. Listed E9809

Installing tools – A, B, C: WT111M, WT110M, WT2000, ERG-2002, WT112M

Installing tools – D, E, F, G: WT115A, TBM6/TBM6S

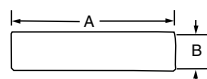

**K**

Sta-Kon®

**Thomas & Betts**

# Sta-Kon® Splice Connectors



## Overlap Type Splices

Wires are laid side by side in the connector, and the connection is made in one crimp. These splices offer advan-

tages in simplicity of installation, and small size. One crimp completes the splice.



## Nylon Insulated Splices – Overlap Type (Parallel)

Cat. No.	Pkg. Qty.	Wire Range	Wt./Lbs. Per 1000	Dimensions	
				A	B
2A20	100	22-20	2	.84	.20
RAA24	1000	22-20	2	.84	.20
2B-16	100	18-16	2	.84	.23
RBB25	1000	18-16	2	.84	.23
2C-12	50	14-12	4	.90	.28
RCC26	500	14-12	4	.90	.28

U.L. Listed E9809  
Installing tools: WT2000, WT112M

## High-Tech Splice-Overlap Type (Parallel)

Cat. No.	Pkg. Qty.	Wire Range	Wt./Lbs. Per 1000	Dimensions	
				A	B
675-1425	1000	18-16	3	.31	.16



## Non-Insulated Splices – Overlap Type

Cat. No.	Pkg. Qty.	Wire Range	Wt./Lbs. Per 1000	Dimensions	
				A	B
2A22-20	100	22-20	2	.31	.12
A1A	1000	22-20	2	.31	.12
2B18-16	100	18-16	3	.31	.16
B1B	1000	18-16	3	.31	.16
2C14-12	50	14-12	4	.37	.22
C1C	500	14-12	4	.37	.22
2D10-9	20	10-9	5	.50	.31
D1D	200	10-9	5	.50	.31
2E8-7	20	8-7	7	.50	.37
E1E	200	8-7	7	.50	.37
2F6-5 <sup>†</sup>	20	6-5	8	.50	.44
F1F	200	6-5	8	.50	.44
2G4-2 <sup>†</sup>	10	4-2	20	.69	.58
G1G	100	4-2	20	.69	.58
H1H	100	2-1	20	.69	.58

<sup>†</sup> Not U.L. Listed. U.L. Listed E9809  
Installing tools – A, B, C: WT110M, WT2000, WT111M, WT112M  
Installing tools – D, E, F, G: WT115A, TBM6/TBM6S

## Tefzel® Insulated Butt Splice

Cat. No.	Pkg. Qty.	Wire Range	Wt./Lbs. Per 1000	Dimensions	Max. Ins Dia.
				A	
RAAT21	1000	22-18	3	1.22	.115
RBBT21	1000	16-14	3	1.22	.148
RCCT21	1000	12-10	7	1.22	.210

Installing tool – WT-145C  
Tefzel® is a registered trademark of DuPont.

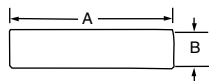

K

Sta-Kon®

# Sta-Kon® Disconnects

Disconnect terminals provide a quick, reliable method of connection to terminal blocks and boards without the use of tools. They are supplied in a variety of styles to meet virtually all quick-disconnect requirements. Female disconnect terminals and matching male tabs accommodate a range of 22-10 AWG, and are available in non-insulated, par-

tially insulated, and fully insulated styles, in both nylon and vinyl. They are available in various tab widths including .250", .187", and .110", and a combination size. A unique construction of the female disconnect offers long-term dependability. The brazed seam serrated barrel provides maximum tensile strength.



### RA18-250F

nylon self-insulated  
installing tools – WT145C,  
WT2000, ERG-2001,  
ERG-2003, WT112M



### 18RA-250F

vinyl self-insulated  
installing tools – WT145C,  
WT2000, ERG-2001,  
ERG-2003, WT112M



### 18RA-2577

nylon fully-insulated  
installing tools – WT145C,  
WT2000, ERG-2001,  
ERG-2003, WT112M



### RAS18-250AX

heat-shrinkable fully  
insulated disconnects  
installing tool – WT1255

## 250 Series – Female Disconnects

Cat. No.	Pkg. Qty.	Wire Range	Max. Ins.	Tab Size	Wt./Lbs. Per 1000	Dimensions	
						A	B
1 RA18-250F	100	22-18	.136	.250 x .032	4	.91	.29
RA250	1000	22-18	.136	.250 x .032	4	.91	.29
RB14-250F	100	16-14	.162	.250 x .032	4	.91	.29
RB250	1000	16-14	.162	.250 x .032	4	.91	.29
RC10-250F	50	12-10	.215	.250 x .032	4	1.04	.29
RC250	500	12-10	.215	.250 x .032	4	1.04	.29
2 18RA-250F	100	22-18	.150	.250 x .032	3	.96	.29
RA257	1000	22-18	.150	.250 x .032	3	.96	.29
RA257-170	1000	22-18	.170	.250 x .032		.96	.29
14RB-250F	100	16-14	.170	.250 x .032	3	.96	.29
RB257	1000	16-14	.170	.250 x .032	3	.96	.29
RB257-200	1000	16-14	.200	.250 x .032		.96	.29
10RC-250F	50	12-10	.250	.250 x .032	4	1.03	.29
RC257	500	12-10	.250	.250 x .032	4	1.03	.29
3 18RA-2577	100	22-18	.165	.250 x .032	3	1.01	.38
RA2573	1000	22-18	.165	.250 x .032	3	1.01	.38
14RB-2577	100	16-14	.185	.250 x .032	4	1.01	.38
RB2573	1000	16-14	.185	.250 x .032	4	1.01	.38
10RC-2577	50	12-10	.225	.250 x .032	5	1.04	.38
RC2573	500	12-10	.225	.250 x .032	5	1.04	.38
4 RAS18-250AX	50	22-18	.170	.250 x .032	4	1.83	–
RBS14-250AX	50	16-14	.200	.250 x .032	5	1.78	–
RCS10-250AX	25	12-10	.250	.250 x .032	6	1.80	–

Material: brass  
Finish: tin plated  
U.L. Listed **E66716**



*Most standard bulk catalog numbers can be put on Mylar Tape for reel fed applications (i.e. 12050 tool and application dies). See pages K61- K62 for description of tooling. Please add the suffix "M" for Mylar Tape (i.e. RA2573-M).*

K  
Sta-Kon®



①



**RA18-250A**  
nylon open top  
insulated 90° flag  
installing tools –  
WT145C, WT2000,  
ERG-2001, ERG-2003,  
WT112M

②



**A18-250**  
non-insulated  
installing tools – WT111M,  
WT1110M, WT2000,  
ERG-2002, WT112M

③



**B14-250F**  
non-insulated/insulation  
grip installing  
tool – WT110M

④



**A18-250A**  
non-insulated 90° flag  
installing tools –  
WT110M, WT111M,  
WT2000, ERG-2002,  
WT112M

⑤

### 250 Series – Female Disconnects – continued

	Cat. No.	Pkg. Qty.	Wire Range	Max. Ins.	Tab Size	Wt./Lbs. Per 1000	Dimensions	
							A	B
①	<b>RA18-250A</b>	50	22-18	.170	.250 x .032	4	.80	.71
	<b>RA2577F</b>	500	22-18	.170	.250 x .032	4	.80	.71
	<b>RB14-250A</b>	50	16-14	.190	.250 x .032	5	.80	.72
	<b>RB2577F</b>	500	16-14	.190	.250 x .032	5	.80	.72
	<b>RC10-250A</b>	50	12-10	.245	.250 x .032	6	.80	.88
②	<b>RC2577F</b>	500	12-10	.245	.250 x .032	6	.80	.88
	<b>A18-250</b>	100	22-18	–	.250 x .032	3	.73	.31
	<b>A250</b>	1000	22-18	–	.250 x .032	3	.73	.31
	<b>B14-250</b>	100	16-14	–	.250 x .032	3	.73	.31
	<b>B250</b>	1000	16-14	–	.250 x .032	3	.73	.31
③	<b>C10-250F</b>	50	12-10	–	.250 x .032	4	.73	.31
	<b>C250</b>	500	12-10	–	.250 x .032	4	.73	.31
③	<b>B14-250F</b>	100	16-14	–	.250 x .032	5	.87	.31
	<b>B250G</b>	1000	16-14	–	.250 x .032	5	.87	.31
④	<b>A18-250A</b>	50	22-18	–	.250 x .032	3	.58	.61
	<b>A252G</b>	500	22-18	–	.250 x .032	3	.58	.61
	<b>B14-250A</b>	50	16-14	–	.250 x .032	3	.58	.62
	<b>B252G</b>	500	16-14	–	.250 x .032	3	.58	.62
	<b>C10-250A</b>	50	12-10	–	.250 x .032	4	.64	.63
	<b>C252G</b>	500	12-10	–	.250 x .032	4	.64	.63

U.L. Listed E66716

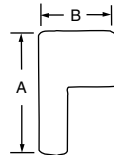
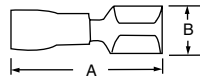

### 250 Series – Piggy Back Disconnects – Nylon Insulated

	Cat. No.	Pkg. Qty.	Wire Range	Max. Ins.	Tab Size	Wt./Lbs. Per 1000	Dimensions		
							A	B	C
⑤	<b>RA18-250FP</b>	100	22-18	.136	.250 x .032	3	.87	.30	.43
	<b>RA250P</b>	1000	22-18	.136	.250 x .032	3	.87	.30	.43
	<b>RB14-250FP</b>	100	16-14	.163	.250 x .032	3	.87	.30	.43
	<b>RB250P</b>	1000	16-14	.163	.250 x .032	3	.87	.30	.43

For stacking applications  
Installing Tool – WT112M

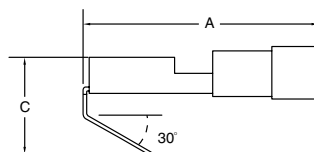
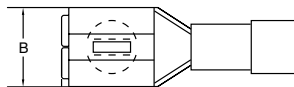

Most standard bulk catalog numbers can be put on Mylar Tape for reel fed applications (i.e. 12050 tool and application dies). See pages K61- K62 for description of tooling.  
Please add the suffix "M" for Mylar Tape (i.e. RA2573-M).



# Sta-Kon®

## Disconnects



**RAD18-183**  
nylon self-insulated  
installing tools – WT145C,  
WT2000, ERG-2001,  
ERG-2003, WT112M



**18RAD-183**  
vinyl self-insulated  
installing tools – WT145C,  
WT2000, ERG-2001,  
ERG-2003, WT112M



**18RAD-18377**  
nylon fully-insulated  
installing tools – WT145C,  
WT2000, ERG-2001,  
ERG-2003, WT112M



**AD18-183**  
non-insulated  
installing tools –  
WT111M, ERG-2002,  
WT2000, WT112M,



**RAD18-187A**  
nylon fully-insulated 90° flag  
installing tools – WT1145C,  
WT2000, ERG-2001,  
ERG-2003, WT112M

*Disconnect terminals provide a quick, reliable method of connection to terminal blocks and boards without the use of tools. They are supplied in a variety of styles to meet virtually all quick-disconnect requirements. Female disconnect terminals and matching male tabs accommodate a range of 22-10 AWG, and are available in non-insulated, partially insulated, and fully insulated styles, in both nylon and vinyl. They are available in various tab widths including .250", .187", and .110", and a combination size. A unique construction of the female disconnect offers long-term dependability.*

### 187 Series – Female Disconnects

Cat. No.	Pkg. Qty.	Tab Size	Wire Range	Max. Ins. Dia.	Dimensions	
					A	B
① <b>RAD18-183</b>	100	.187 x .032	22-18	.136	.83	.23
<b>RAD1833</b>	1000	.187 x .032	22-18	.136	.83	.23
<b>RAD18-182</b>	100	.187 x .020	22-18	.136	.83	.23
<b>RAD1823</b>	1000	.187 x .020	22-18	.136	.83	.23
<b>RBD14-183</b>	100	.187 x .032	16-14	.163	.83	.23
<b>RBD1833</b>	1000	.187 x .032	16-14	.163	.83	.23
<b>RBD14-182</b>	100	.187 x .020	16-14	.163	.83	.23
<b>RBD1823</b>	1000	.187 x .020	16-14	.163	.83	.23
② <b>18RAD-183</b>	100	.187 x .032	22-18	.150	.85	.23
<b>RAD1837</b>	1000	.187 x .032	22-18	.150	.85	.23
<b>18RAD-182</b>	100	.187 x .020	22-18	.150	.85	.23
<b>RAD1827</b>	1000	.187 x .020	22-18	.150	.85	.23
<b>14RBD-183</b>	100	.187 x .032	16-14	.170	.85	.23
<b>RBD1837</b>	1000	.187 x .032	16-14	.170	.85	.23
<b>14RBD-182</b>	100	.187 x .020	16-14	.170	.85	.23
<b>RBD1827</b>	1000	.187 x .020	16-14	.170	.85	.23
③ <b>18RAD-18377</b>	100	.187 x .032	22-18	.150	.89	.30
<b>RAD18377</b>	1000	.187 x .032	22-18	.150	.89	.30
<b>18RAD-18277</b>	100	.187 x .020	22-18	.150	.89	.30
<b>RAD18277</b>	1000	.187 x .020	22-18	.150	.89	.30
<b>14RBD-18377</b>	100	.187 x .032	16-14	.170	.89	.30
<b>RBD18377</b>	1000	.187 x .032	16-14	.170	.89	.30
<b>14RBD-18277</b>	100	.187 x .020	16-14	.170	.89	.30
<b>RBD18277</b>	1000	.187 x .020	16-14	.170	.89	.30
④ <b>AD18-183</b>	100	.187 x .032	22-18	–	.64	.23
<b>AD183</b>	1000	.187 x .032	22-18	–	.64	.23
<b>AD18-182</b>	100	.187 x .020	22-18	–	.64	.23
<b>AD182</b>	1000	.187 x .020	22-18	–	.64	.23
<b>BD14-183</b>	100	.187 x .032	16-14	–	.64	.23
<b>BD183</b>	1000	.187 x .032	16-14	–	.64	.23
<b>BD14-182</b>	100	.187 x .020	16-14	–	.64	.23
⑤ <b>RAD18-187A</b>	50	.187 x .032	22-18	.150	.74	.59
<b>RAD1877F</b>	500	.187 x .032	22-18	.150	.74	.59
<b>RAD18-188A</b>	50	.187 x .020	22-18	.150	.74	.59
<b>RAD1887F</b>	500	.187 x .020	22-18	.150	.74	.59
<b>RBD14-187A</b>	50	.187 x .032	16-14	.170	.74	.61
<b>RBD1877F</b>	500	.187 x .032	16-14	.170	.74	.61
<b>RBD14-188A</b>	50	.187 x .020	16-14	.170	.74	.61
<b>RBD1887F</b>	500	.187 x .020	16-14	.170	.74	.61

U.L. Listed E66716

Material: brass

Finish: tin plated

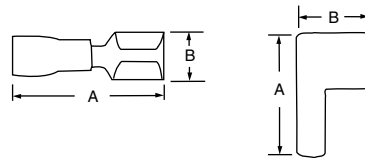

*Most standard bulk catalog numbers can be put on Mylar Tape for reel fed applications (i.e. 12050 tool and application dies). See pages K61- K62 for description of tooling. Please add the suffix "M" for Mylar Tape (i.e. RA2573-M).*

K

Sta-Kon®

**Thomas & Betts**



**18RA-250T**  
vinyl self-insulated  
installing tools – WT145C,  
WT2000, ERG-2001,  
ERG-2003, WT112M



**18RA-251T**  
nylon fully insulated  
installing tools – WT145C,  
WT2000, ERG-2001,  
ERG-2003, WT112M



**18RAS-251TX**  
heat shrinkable nylon fully  
insulated  
installing tool – WT1255



**A18-250T**  
Non-insulated/insulated grip  
installing tool – WT110M



**18-251T**  
Non-insulated  
installing tools – WT110M,  
WT111M, WT2000,  
WT112M, ERG-2002, WT112M

### 250 Series – Male Tabs

	Cat. No.	Pkg. Qty.	Wire Range	Max. Ins.	Tab Size	Wt./Lbs. Per 1000	Dimensions	
							A	B
①	<b>18RA-250T</b>	100	22-18	.150	.250 x .032	3	.95	–
	<b>RA2517</b>	1000	22-18	.150	.250 x .032	3	.95	–
	<b>14RB-250T</b>	100	16-14	.170	.250 x .032	3	.95	–
	<b>RB2517</b>	1000	16-14	.170	.250 x .032	3	.95	–
	<b>10RC-250T</b>	50	12-10	.250	.250 x .032	4	1.08	–
	<b>RC2517</b>	500	12-10	.250	.250 x .032	4	1.08	–
②	<b>18RA-251T</b>	50	22-18	.150	.250 x .032	5	1.13	.45
	<b>RA25177</b>	500	22-18	.150	.250 x .032	5	1.13	.45
	<b>14RB-251T</b>	50	16-14	.170	.250 x .032	5	1.13	.45
	<b>RB25177</b>	500	16-14	.170	.250 x .032	5	1.13	.45
	<b>10RC-251T</b>	25	12-10	.210	.250 x .032	5	1.17	.45
	<b>RC25177</b>	500	12-10	.210	.250 x .032	5	1.17	.45
③	<b>18RAS-251TX</b>	50	22-18	.170	.250 x .032	4	1.80	–
	<b>14RBS-251TX</b>	100	16-14	.200	.250 x .032	5	1.75	–
	<b>10RCS-251TX</b>	100	12-10	.250	.250 x .032	6	1.80	–
④	<b>A18-250T</b>	100	22-18	–	.250 x .032	3	.87	–
	<b>B14-250T</b>	100	20-14	–	.250 x .032	3	.87	–
⑤	<b>A18-251T</b>	100	22-18	–	.250 x .032	2	.68	–
	<b>A251</b>	1000	22-18	–	.250 x .032	2	.68	–
	<b>B14-251T</b>	100	16-14	–	.250 x .032	2	.68	–
	<b>B251</b>	1000	16-14	–	.250 x .032	2	.68	–
	<b>C10-251T</b>	50	12-10	–	.250 x .032	2	.68	–

Material: brass  
Finish: tin plated

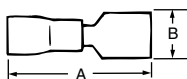

**Most standard bulk catalog numbers can be put on Mylar Tape for reel fed applications (i.e. 12050 tool and application dies). See pages K61- K62 for description of tooling. Please add the suffix "M" for Mylar Tape (i.e. RA2573-M).**

K

Sta-Kon®



**18RAD-187**  
vinyl insulated  
installing tools – WT145C,  
WT2000, ERG-2001,  
ERG-2003, WT112M

### 187 Series – Male Tabs

Cat. No.	Pkg. Qty.	Tab Size	Wire Range	Max Ins.	Wt./Lbs. Per 1000	Dia. A
① <b>18RAD-187</b>	100	.187 x .032	22-18	.150	4	.87
<b>18RAD-188</b>	100	.187 x .020	22-18	.150	4	.87
<b>14RBD-187</b>	100	.187 x .032	16-14	.170	4	.87
<b>14RBD-188</b>	100	.187 x .020	16-14	.170	4	.87

U.L. Listed E66716  
Material: brass  
Finish: tin plated

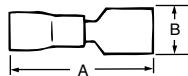

**RA18-111F**  
nylon-insulated  
installing tool –  
WT465

### 110 Series – Disconnects \*

Cat. No.	Pkg. Qty.	Tab Size	Wire Range	Max Ins.	Wt./Lbs. Per 1000	Dimensions	
						A	B
② <b>RA18-110F</b>	100	.110 x .032	22-18	.110	4	.75	.15
<b>RA10</b>	1000	.110 x .032	22-18	.110	4	.75	.15
<b>RA18-111F</b>	100	.110 x .020	22-18	.110	4	.75	.15
<b>RA11</b>	1000	.110 x .020	22-18	.110	4	.75	.15
<b>RB14-110F</b>	100	.110 x .032	16-14	.135	4	.75	.15
<b>RB10</b>	1000	.110 x .032	16-14	.135	4	.75	.15
<b>RB14-111F</b>	100	.110 x .020	16-14	.135	4	.75	.15
<b>RB11</b>	1000	.110 x .020	16-14	.135	4	.75	.15
③ <b>A18-110F</b>	100	.110 x .032	22-18	–	3	.59	.15
<b>A10</b>	1000	.110 x .032	22-18	–	3	.59	.15
<b>A18-111F</b>	100	.110 x .020	22-18	–	3	.59	.15
<b>A11</b>	1000	.110 x .020	22-18	–	3	.59	.15
<b>B14-110F</b>	100	.110 x .032	16-14	–	3	.59	.15
<b>B10</b>	1000	.110 x .032	16-14	–	3	.59	.15
<b>B14-111F</b>	100	.110 x .020	16-14	–	3	.59	.15
<b>B11</b>	1000	.110 x .020	16-14	–	3	.59	.15

\*Not U.L. Listed or CSA approved.  
Material: brass  
Finish: tin plated

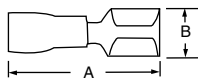

**A18-111F**  
non-insulated  
installing tool –  
WT111M, WT2000,  
WT112M

*Most standard bulk catalog numbers can be put on Mylar Tape for reel fed applications (i.e. 12050 tool and application dies). See pages K61-K62.  
Please put the suffix M for Mylar Tape RA2573M. (Bulk number 1000 and 500 packages.)*

K  
Sta-Kon®

# Sta-Kon®

## Disconnects



**RB14-250**  
insulated coupler  
no tool required  
Male

### 250 Series – Adapters & Coupler †

Cat. No.	Pkg. Qty.	Tab Size	Wt./Lbs. Per 1000	Dimensions	
				A	B
① <b>F250TA</b>	50	.250 x .032	3	.82	.56
<b>FTA250</b>	500	.250 x .032	3	.82	.56
② <b>RB14-250</b>	50	.250 x .032	7	2.35	.51
<b>RBB250</b>	500	.250 x .032	7	2.35	.51

† Not U.L. Listed

Cat. No. F250TA –

Material: brass  
Finish: tin plated

Cat. No. RB14-250 –

Material: brass  
Finish: none  
Insulation: vinyl

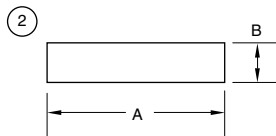
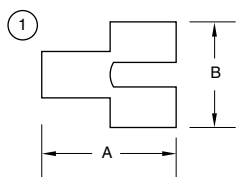

K

Sta-Kon®



**RA18D**  
Nylon-insulated wire barrels  
installing tool –  
WT2000 (Not U.L.)



**B14-D**  
non-insulated/insulation grip  
installing tool –  
WT110M (Not U.L.)

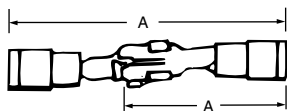

**Nylon Insulated and Non-insulated**  
Picture shows wristlock assembled as 2  
pieces. Parts are sold by the piece not  
assemblies.

### Wristlock Disconnects †

Cat. No.	Pkg. Qty.	Wire Range	Max. Ins.	Wt./Lbs. Per 1000	Dimensions	
					A	A1
<b>RA18D</b>	50	22-18	.136	4	.99	1.70
<b>RA23</b>	500	22-18	.136	4	.99	1.70
<b>RB14D</b>	50	16-14	.162	4	.99	1.70
<b>RB23</b>	500	16-14	.162	4	.99	1.70
<b>B14-D</b>	50	16-14	.187	4	.97	1.66
<b>B23</b>	500	16-14	.187	4	.97	1.66

† Not U.L. Listed

Note: Not available on Mylar Tape.

**Thomas & Betts**

# Sta-Kon®

## Pin Terminals/Vinyl Terminals (Mini-Pack)



- Convenient 20-count packaging.
  - Wire ranges from 22 AWG to 10 AWG.
  - Vinyl Insulated Ring and forked-tongued terminals, female disconnects, butt-type splice connectors.
- Note:** "CP" designates mini-pack quantities. Refer to other catalog pages for description and dimensional information.

### Sta-Kon® Mini-Pack Terminals

Cat. No.	Unit Qty.	Std. Pack.	Wire Range	Bolt Hole
18RA-6FCP	20	100	22-18	#6
18RA-8CP	20	100	22-18	#8
18RA-10CP	20	100	22-18	#10
14RB-6CP	20	100	16-14	#6
14RB-8CP	20	100	16-14	#8
14RB-10CP	20	100	16-14	#10
10RC-10CP	20	100	12-10	#10
10RC-14CP	20	100	12-10	¼
18RA-8FCP	20	100	22-18	#8
18RA-10FCP	20	100	22-18	#10
14RB-6FCP	20	100	16-14	#6
14RB-8FCP	20	100	16-14	#8
14RB-10FCP	20	100	16-14	#10
10RC-8FCP	20	100	12-10	#8
10RC-10FCP	20	100	12-10	10
2RA18XCP	20	100	22-18	-
2RB14XCP	20	100	16-14	-
2RC10XCP	20	100	12-10	-
18RA-250FCP	20	100	22-18	-
14RB-250FCP	20	100	16-14	-
10RC-250FCP	20	100	12-10	-

U.L. Listed E9809

K

Sta-Kon®

Thomas & Betts



Sta-Kon® wire joints come in one-piece nylon, self-insulated and non-insulated, and a two-piece nylon insulator. Tool applied.

### Crimp on Wire Joints – Tool Applied

Cat. No.	Pkg. Qty.	Wire Range		Dimensions		Wt./Lbs. Per 1000
		Min.	Max.	A	B	
① RB44	100	2#18	2#16	.31	.78	
RB4	1000			–	–	2
RC55	50	4#18	2#12	.43	.95	3
RC6	500			–	–	3
RP12	100	3#14	4#12	.53	1.00	
RP7	1000			–	–	
② PT66M	100	2#18	3#12 combination	–	–	4
PT6M	100	–	Insulator only	.50	.93	2
PT60M	100	2#14	3#12 Connector only	.31	.37	2
③ PT70	200	2#14	3#12	.29	.34	2
PT70M	200	3#18	4#12	.31	.37	2
PT80	50	2#16	4#10	.35	.62	6

U.L. Listed E9809

Items on this page sold in multiples of unit packages only.

### Installation Procedure for “PT” Connectors



Twist wires, insert through serrated barrel of wire joint. (PT60M, PT70, PT70M, PT80).



Crimp and trim off excess wire with WT161M hand tool.

Screw PT6 insulator firmly onto PT160M barrel.

K

Sta-Kon®

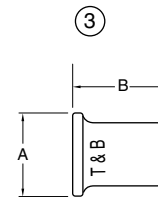
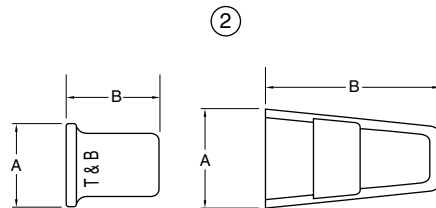
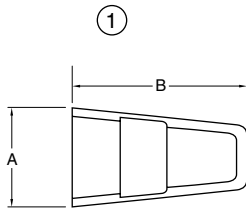

Cat. No.	Allowable Wire Combinations							Cat. No.	Allowable Wire Combinations							Cat. No.	Allowable Wire Combinations						
	#22	#20	#18	#16	#14	#12	#10		#22	#20	#18	#16	#14	#12	#10		#22	#20	#18	#16	#14	#12	#10
RB4/RB44	2-3							RC6/RC55	1-4							RP7/RP12	2						
	1-2 2								1-3								1 1						
	3								1-2 1								1 1						
	3								2								2-4						
	3 1								3-5 1								2-4 1						
	2 3								2-4 1								1-3 2						
	1-2 2								3								1 3						
	2 1								1-4 2								3-6						
	3 1								1-3 2								1 2-3						
	1 2								1-3 3								2 1-2						
2 1							1 3							3 1-2									
1 2							2-5							4 1									
							4-6																

# Sta-Kon®

## Installing Kits

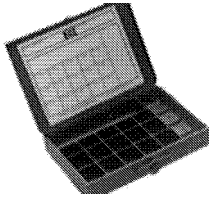

ORG-2



### Wiring Organizer

Cat. No.	Description	Std. Pkg.	Wt.
ORG2	Heavy Duty Steel Drawer with (17) compartments to hold Sta-Kon® terminals, Color-Keyed® lugs, Ty-Rap® cable ties, and other small parts	1	4

Drawer does not include Thomas & Betts products.

### Sta-Kit

For residential or light commercial installations we recommend this proven assortment of popular Sta-Kon® vinyl terminals. This kit includes a WT112M crimping tool.

Cat. No.	Description	Std. Pkg.	Wt.
STAKIT	100 2RA18X butt splices for 22-18 AWG,	1	1
	100 2RB14X butt splices for 18-14 AWG,		
	50 2RC10X butt splices for 12-10 AWG,		
	50 10RC-10 ring terminals for 12-10 AWG,		
	50 10RC-10FL locking fork terminals for 12-10 AWG,		
	50 10RC-250F disconnects for 12-10 AWG,		
	100 14RB-10 ring terminals for 18-14 AWG,		
	100 14RB-8FL locking fork terminals for 18-14 AWG,		
	100 14RB-250F disconnects for 18-14 AWG,		
	100 18RA-8F Fork Terminals for 22-18 AWG,		
	100 18RA-6FL locking fork terminals for 22-18 AWG,		
	100 18RA-250F disconnects for 22-18 AWG		
	1 WM-0-9 wire marker book		
	1 WT112M crimping tool and 100 TY525M Ty-Rap® cable ties (approx. length 7½")		

(All splices, terminals and disconnects are vinyl insulated).

K

Sta-Kon®

# Sta-Kon®

## Application Tools



WT110M



WT111M



WT112M

*These tools are designed in a variety of styles—some with wire cutters and strippers—for installation of the various STA-KON terminal series. #22-10 AWG wire range.*

### Plier Type Tools

Cat. No.	Description	Std. Pkg.	Wt. Each
WT110M	A, B, C non-insulated terminal and splices and A, B non-insulated terminals with insulation grip	1	1
WT111M	A, B, C, PT non-insulated terminal and splices	1	1
WT112M	RA, RB, A, B, C, non-insulated and RC insulated nylon and vinyl terminal and splices	1	1

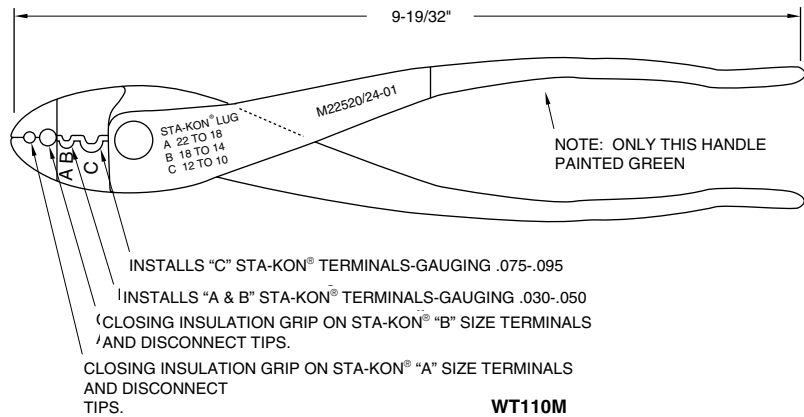

*Installs "C" Sta-Kon® terminals-gauging .075-.095*  
*Installs "A" & "B" Sta-Kon® terminals-gauging .030-.050*  
*Closing Insulation Grip on Sta-Kon® "B" size terminals and disconnect tips.*  
*Closing Insulation Grip on Sta-Kon® "A" size terminals and disconnect tips.*

K

Sta-Kon®

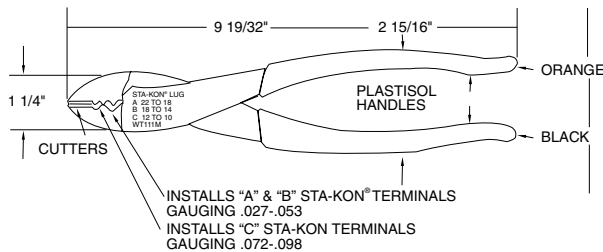

WT111M

**Cutters**  
 Installs "A" & "B" Sta-Kon® terminals gauging .027-.053.  
 Installs "C" Sta-Kon® terminals gauging .072-.098.

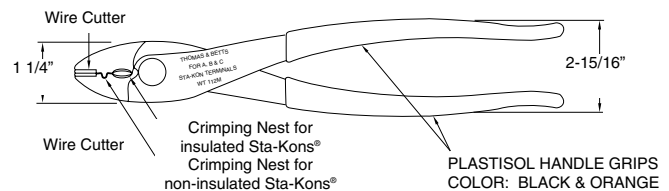

WT112M

*Installs insulated and non-insulated Sta-Kon® terminals, splices, disconnects, and wire joints 22-10 AWG.*



# Sta-Kon®

## Application Tools



WT161M



WT2000

*These tools are designed in a variety of styles—some with wire cutters and strippers—for installation of the various STA-KON terminal series. #22-10 AWG wire range.*

### Plier Type Tools – (Continued)

Cat. No.	Description	Std. Pkg.	Wt. Each
WT161M	A, B, C, PT non-insulated terminal and splices	1	1
WT2000	A, B, C: AB, PT, RA, RB, RC insulated and non-insulated terminal and splices	1	

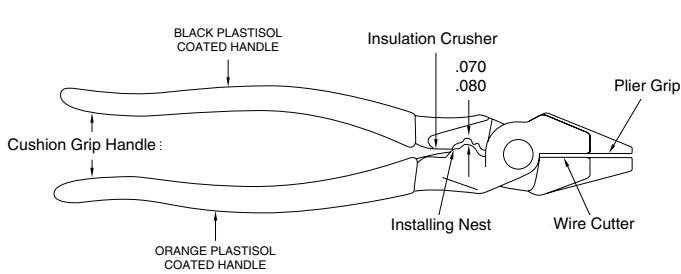

WT161M

*Installs "A," "B," and "C" size (#18-#10 wire) Sta-Kon terminals, splices, and wire joints (PT-60M and PT-70).*

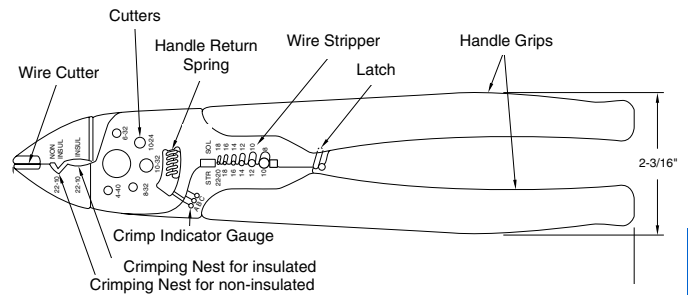

WT2000

*Wire Cutter—No. 10 AWG and smaller solid or stranded wire.*

*Crimping Nests—Insulated and non-insulated Sta-Kon terminals, splices and wire joints on No. 22 to No. 10 AWG, solid or stranded wire.*

*Cutters—Chasing feature for screws, sizes 4-40, 6-32, 8-32, 10-24, 10-32.*

*Wire Stripper—Removes most types of insulation from No. 22-10 AWG stranded wire and No. 18-8 AWG solid wire.*

**K**

Sta-Kon®

# Sta-Kon®

## Application Tools

For easy visual verification of crimps, integrity dots are embossed on the top and bottom of the terminal.

toggle action increases mechanical gain, which dramatically reduces handle force – and the stress on your hands.

Advanced ergonomic design of handle distributes the force more evenly across the hand.

Color-coded die nests on both the right and left sides of the tool are included for insulated terminals.

Shure-Stake® mechanism helps to ensure a complete crimp cycle before it releases the tool.

Rubberized thermoplastic handle combines maximum friction with a soft, comfortable feel that reduces muscle tension.

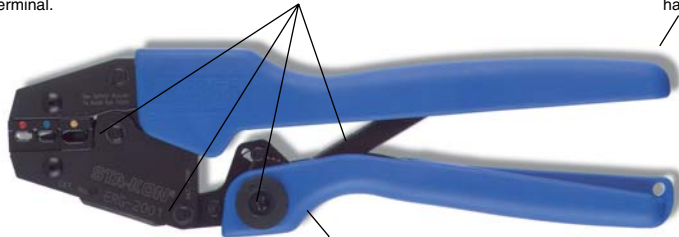

ERG-2001



ERG-2002



ERG-2003

*Our ERG-2003 AWG two-nest model is designed to perform 85% of your terminations with even less handle force than our ERG-2001. For the additional 12-10 AWG range, specify our three-nest insulated or non-insulated Comfort Crimp™ tool.*

### Comfort Crimp® Terminal Tool

#### **Concerned about safety? Down time? Health care costs?**

Thomas & Betts' ergonomically designed Comfort Crimp® tool helps reduce the risk of Carpal Tunnel Syndrome, the cause of almost one out of every two industrial injuries.

This tool's unique design delivers the same reliable crimp with up to 60% less handle force than other terminal hand tools. So you won't have to sacrifice your hand to make a successful crimp. We've researched the tool components to provide maximum comfort to the operator while assuring a complete crimp.

Just wrap your hands around our Comfort Crimp® terminal tool. It's such a relief you won't want to handle any other tool ever again.

K

Sta-Kon®

**Thomas & Betts**

# Sta-Kon®

## Application Tools



ERG-2001



ERG-2008

### Comfort Crimp® Terminal Tool

Cat. No.	Description	Std. Pkg.
ERG-2001	RA, RB, RC Nylon & vinyl terminals, splices & disconnects	1
ERG-2002	A, B, C Non-insulated terminals, splices, disconnects	1
ERG-2004	C and C Flag terminal AB Flag terminal and A, B, C non-insulated terminals, splices, disconnects	1
ERG-2005	B, C, D Non-insulated terminals, splices, (D tubular only)	1
ERG-2007	RD & RE Insulated terminals (Except Brazed Seam)	1
ERG-2008	Non-insulated terminals #8 AWG - 1/0 AWG	1

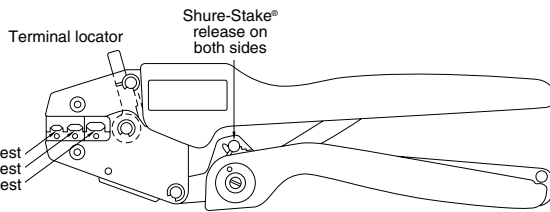

**Installs nylon and vinyl insulated terminals, disconnects, and splices 22-10/22-14 AWG.**

**The force required to release the Shure-Stake® mechanism should be no less than 15 lbs.**

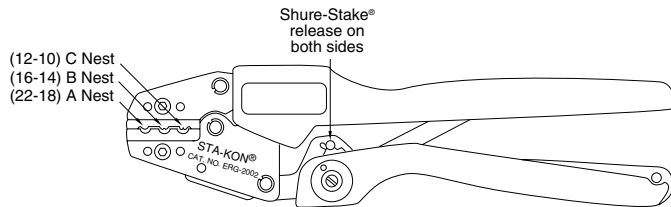

**Installs Non-insulated Terminals, Disconnects, and Splices 22 - 10 AWG.**

**The force required to release the Shure-Stake® mechanism should be no less than 15 lbs.**

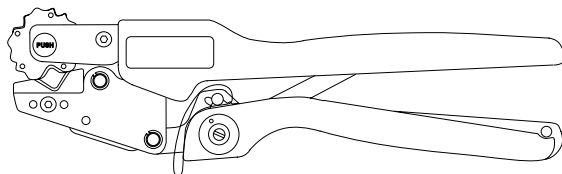

**Installs Non-insulated Terminals #8 AWG - 1/0 AWG.**

**UL Listed crimp per UL standard 486C on tubular D, E, F, G, and H style Sta-Kon® Terminals.**

### Tool Gaging Requirements

Cat. No.	Nest	Gaging Min.-Max.
ERG-2001	RA	.100—.106
	RB	.116—.124
	RC	.148—.156
ERG-2002	A	.062—.067
	B	.084—.089
	C	.110—.115
ERG-2004	AB	.062—.067
	C	.110—.115
ERG-2005	B	.082—.090
	C	.117—.125
	D	.145—.153
ERG-2007	8 (RED)	.190—.196
	6 (BLUE)	.212—.218
ERG-2008	Self-Contained Rotating Die	8AWG - 1/0 AWG

• Gauges available from T&B Tool Service

### ERG-2001/ERG-2003

Nest	Gaging Min.-Max.
Red	.100 - .106
Blue	.116 - .124
Yellow	.148 - .156

### ERG-2002

Nest	Gaging Min.-Max.
A	.067 - .062
B	.089 - .084
C	.115 - .110

**Thomas & Betts**

# Sta-Kon®

## Application Tools



### Ratchet Hand Tools

Cat. No.	Description
WT145A	RA, RAX, RB, RBC, RC, RAA, RBB, RBC, RCC nylon terminal

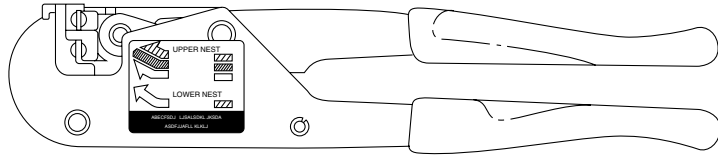

WT145A

Installs RA, RB, RBC, RC nylon terminals. Correct compression every time—the Shure-Stake® mechanism principle prevents opening of the handles until full staking action is completed. Installs self-insulated and non-insulated Sta-Kon® terminal series in the #26-10 AWG wire range.

With the “Lower” gage (683-G-398) placed into the rectangular side of the lower nest, the force required to release the Shure-Stake® mechanism should be 10-40 lbs.

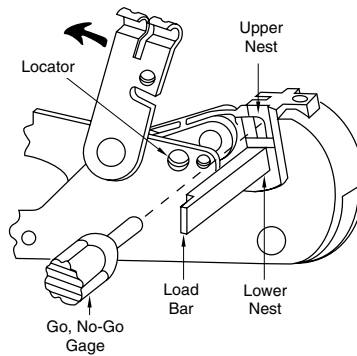

WT145A

Nest	Gaging Min.-Max.
Upper	.097 – .106
Lower	.121 – .128

K

Sta-Kon®



### Ratchet Hand Tools – (Continued)

Cat. No.	Description
WT145C	RA, RB, RC, RAA, RBB, RCC, RBC nylon and vinyl terminals, splices and disconnects

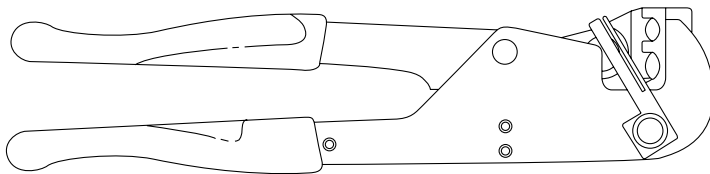

WT145C

Correct compression every time—the Shure-Stake® mechanism principle prevents opening of the handles until full staking action is completed. Installs self-insulated and non-insulated Sta-Kon® terminal series in the #26-10 AWG wire range.

Installs RA, RB, RC nylon terminals, disconnects, splices and RA, RB, RC vinyl terminals, disconnects, splices.

The force required to release the Shure-Stake® mechanism should be 10 lbs. minimum.

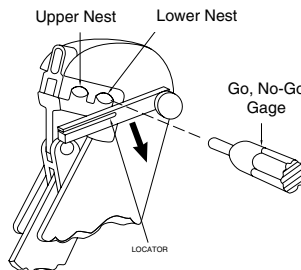

Nest	Gaging Min.-Max.
Upper	.118 – .122
Lower	.169 – .173

# Sta-Kon®

## Application Tools



WT1377

**Installs NW Series Heater Wire Terminals**  
**Correct compression every time—the Shure-Stake® mechanism principle prevents opening of the handles until full staking action is completed. Installs self-insulated and non-insulated Sta-Kon® terminal series in the #26-10 AWG wire range.**

### Ratchet Hand Tools – (Continued)

Cat. No.	Description	Std. Pkg.
WT1377	NW Ring Terminals	1

Use Front Nest to install NW18 series term., NW20 series term., NW22 series term., NW50 series term.  
 Use Rear Nest to install NW10 series term., NW14 series term., NW80 series term., 675-14716 series term.

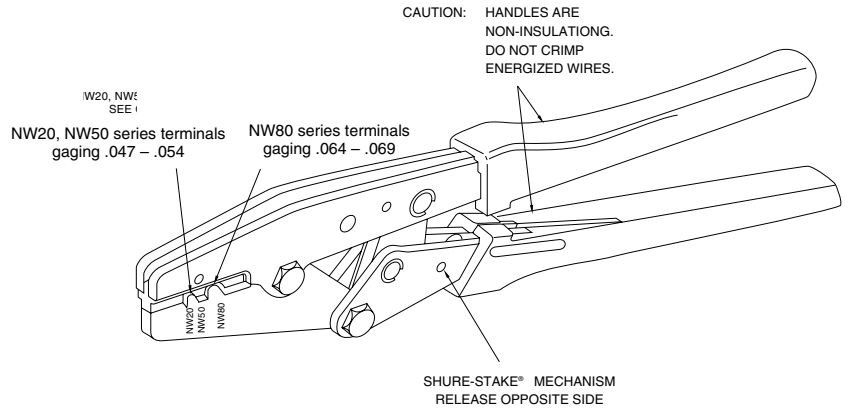

**Installs RZ, RV Terminals (26-22 AWG wire) and Splices.**

### Ratchet Hand Tools – (Continued)

Cat. No.	Description	Std. Pkg.
WT1452	Installs RZ, RV Terminals/Splices	1

Nest	Min. Gage "Go"	Max. Gage "No-Go"
BT	.039	.049
RZ, RV #26-#22	.063	.073

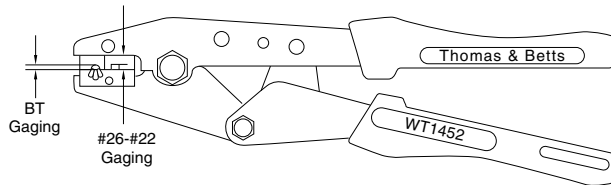

K

Sta-Kon®

# Sta-Kon® Application Tools



WT465

Installs .110 RA, RB disconnects.  
Pre-load requirement: 20-50 lbs.

## Ratchet Hand Tools – (Continued)

Cat. No.	Description	Std. Pkg.
WT465	RA, RB .110 insulated disconnects	1

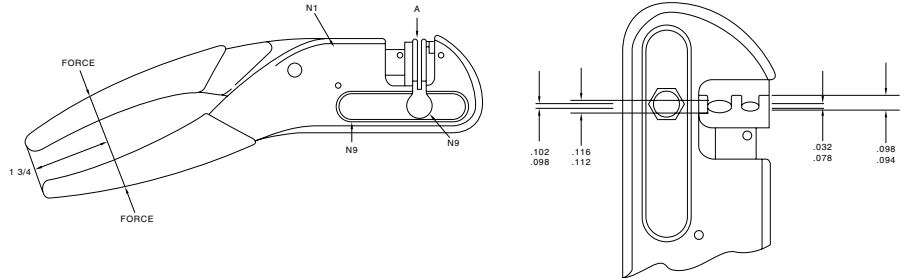

## Ratchet Hand Tools – (Continued)

Cat. No.	Description	Std. Pkg.
WT1255	RA, RB, RC Heat Shrinkable nylon insulated terminals, butt splices and disconnects	1

Pre-load 35 to 45 pounds.

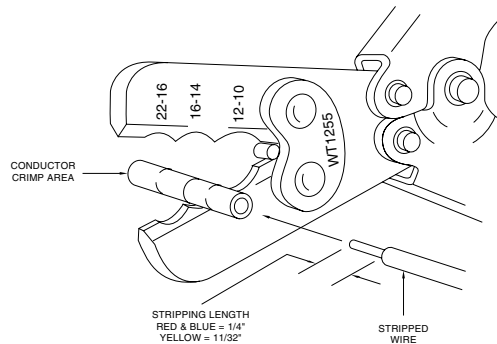

WT1255

Nest	Gaging
22-18	.098/.086
16-14	.113/.101
12-10	.161/.149

K

Sta-Kon®



WT2130A

Installs RBC, RC, RD, Sta-Kon® terminals and RC6 and RP7 wire joints.  
The force required to release the Shure-Stake® mechanism should be 20 lbs. minimum.

## Ratchet Hand Tools – (Continued)

Cat. No.	Description	Std. Pkg.
WT2130A	RC, RBC, and RD insulated terminal #14-#8	1

WT2130A

Nest	Gaging Min.-Max.
12-10	.147 – .157
8	.185 – .195

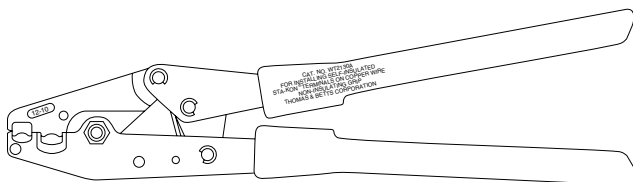

**Thomas & Betts**

# Sta-Kon®

## Application Tools



WT3185

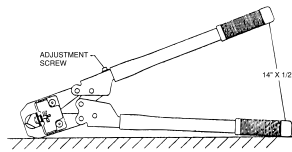
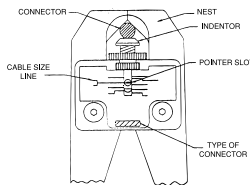

Installs Thomas & Betts Sta-Kon® terminals series D, E, F, and G.



Installs Thomas & Betts Sta-Kon® terminals series D, E, F, and G flag terminals.

### Ratchet Hand Tools – (Continued)

Cat. No.	For Use With Sta-Kon® Series	Std. Pkg.	Wt. Each
WT3185	For 8 AWG to 250 MCM non-insulated Sta-Kon® terminals	1	

### Installation and Gaging Procedure – Adjustable Crimper

#### Gaging Procedure

1. Close the tool jaws until they bottom.
2. Select the side of tool to be gaged (Tubular or Brazed seam)
3. Move indentor until the pointer slot aligns (click) with the selected cable size: For brazed seam connector use 6 AWG. For tubular connectors use 2/0.
4. Gage the crimping area with a suitable pin gage. The gage diameter must fall within .405±.010 tubular and .215±.010 for 6 AWG. brazed product.

#### Checking Handle Pre-load

1. Lay the tool on a flat surface as shown in figure 3. Open handle and release it so that it will close of its own weight.
2. Measure the handle spread distance at the inner surface of the handle tips as shown in figure 3.
3. If the distance is 14"± 1/2" the tool is adjusted properly. If not, the tool should be adjusted.

#### Pre-load Adjustment Procedure

1. Turn Adjustment screw clockwise to increase handle spread and counterclockwise to decrease handle spread. (refer to figure 3.)

### Toggle Type Hand Tools

Cat. No.	For Use With Sta-Kon® Series	Std. Pkg.	Wt. Ea.
WT115A	D, E, F, & G non-insulated terminals	1	4

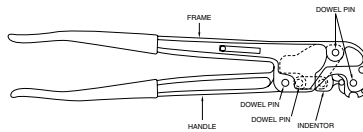

WT115A

### Flag Terminal Type Hand Tool

Cat. No.	Description	Std. Pkg.
WT129	D, E, F, & G non-insulated flag terminals	1

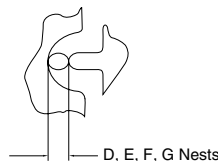

WT115A & WT129A

Nest	Gaging
D	.138 ± .005
E	.170 ± .005
F	.192 ± .005
G	.222 ± .005

# Sta-Kon®

## Application Tools



TBM6

Installs D thru M non-insulated terminals and splices, RD thru RM nylon insulated terminals and splices

Close handles until lower die touches upper die. Measure distance between ends of handles. Distance must be 11" min. and 14" max. If it is less than 11" or more than 14", the tool needs adjustment.

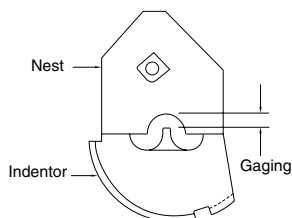

Use in installing tool Cat. No. TBM6 and TBM6S.

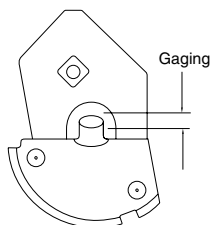

Use in installing tool Cat. No. TBM6 & TBM6S.



### Toggle Type Hand Tools – (Continued)

Cat. No.	For Use With Sta-Kon® Series	Std. Pkg.	Wt. Ea.
TBM6	D thru M (Dies not included) RD thru RM	1	9
TBM6S	D thru M (Dies not included) RD thru RM with Shure-Stake®	1	9

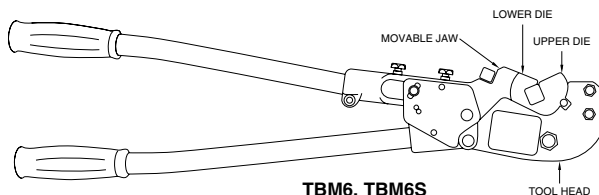

TBM6, TBM6S

### Installing Dies for Non-Insulated Code and Aircraft Sta-Kon® Terminals

Cat. No.		Term. Size	Gaging ± .010
Nest Stationary Die	Indentor Movable Die		
11803		D	.152
11803		E (Tubular)	.152
11805		E (Brazed), F (Tubular)	.167
11806	11802	F (Brazed), G	.206
11807		H	.234
11808		J	.272
11809		K	.250
11810		L	.266
11811		M	.312

### Installing Dies for Nylon Insulated Sta-Kon® Terminals TBM6 & TM6S Tool

Cat. No. Die Set	Term. Size	Gaging ± .010
11821	RD	.170
11822	RE	.202
11823	RF	.254
11824	RG	.321
11825	RH	.339
11826	RJ	.370
11827	RK	.382
11828	RL	.456
11829	RM	.554

### TBM60RS Short Handle Ratchet Tool

Cat. No.	For Use With Sta-Kon Series	Std. Pkg.	Wt. Ea.
TBM60RS	D thru M (Uninsulated terminals) RD thru RM (Insulated terminals)	1	6

For more information, see page K5.

#### Gaging Procedure

1. Ratchet handles until jaws are fully closed.
2. Insert GO, NO-GO gage into nest. GO gage should enter freely. NO-GO gage should not enter.



# Sta-Kon®

## Application Tools



12050

### Safety Features

- Fully guarded foot pedal.
- Dies color matched to terminals.
- Clear plastic safety guard over die area.
- Automatic tool shut-down when safety guard is removed.
- "Ram UP" emergency switch.

**Crimping tape-mounted STA-KON® terminals.**  
**Wire Range – #26 - #10 AWG.**

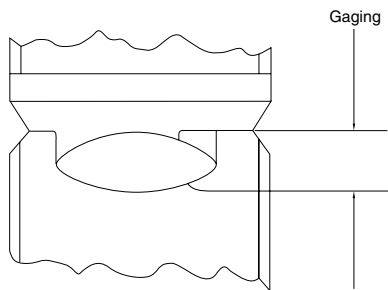

Insulated Terminals

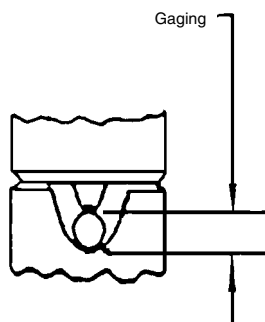

Non-insulated Terminals

## Shure-Stake® Auto-Feed Tool

Cat. No.	Description	Std. Pkg.
12050	Compact, pneumatically operated unit for crimping tape-mounted STA-KON® terminals; equipped with a Shure-Stake® mechanism which ensures a full compression each time	1

Space Requirement – 30" W x 20" H x 20" D

Weight – 55 lbs.

Wire Range – #26 - #10 AWG

Air Pressure 90-125 psi input air supply

### Installing Dies for 12050

Sta-Kon® Terminal Type	AWG Wire Size	Die Cat. No.	Gaging Min.-Max.	Max. Insul. Dia.
RA – Nylon	22-18	12051	.108/.114	.136
RA – Vinyl		12054*	.117/.121	.150
RB – Nylon	16-14	12052	.133/.139	.162
RB – Vinyl		12055*	.122/.126	.170
RC – Nylon and Vinyl Insulated	12-10	12056	.149/.157	.210
A – Non-Insulated	22-18	12057	.061/.068	–
B – Non-Insulated	16-14	12058	.083/.090	–
C – Non-Insulated	12-10	12059	.126/.134	–
C Disconnect, Non-Insul	12-10	12060	.103/.111	–
RV – RZ	26-24	683-54335	.075/.081	–

\* Can also be used on nylon.

**K**

Sta-Kon®

# Sta-Kon®

## Application Tools



K

Sta-Kon®

- Die release knob cuts power to the tool head and protects fingers when changing die sets.
- Quickly interchangeable dies accommodate Sta-Kon terminals from 22 to 6 AWG series connectors.
- LEDs on tool head indicate when a work cycle is complete and the tool head is ready.
- Low force actuating button initiates and completes the crimping work cycle.
- Swiveling tool head allows positioning for maximum comfort and convenience.
- Control lever opens the dies, allowing terminal to be inserted for crimping.
- Tough PanaVise™ benchmount clamp holds tool head securely.
- Base power unit houses the hydraulic pump, fluid reservoir, and electronic control unit. Closed system for low maintenance.
- Easy-to-see lamps indicate when the ERG 3000 is ready to operate.
- Separate AC adapter can be used for bench mount or stationary application.
- Foot pedal allows for “hands-free” crimping, resting wrists and allowing for increased speed.

### Technical data for the ERG 3000

#### Base Unit

Working pressure	3625 psi
Power supply	NiCd Battery 12 V DC or AC/DC converter 110 V 60 Hz

Work cycle	1-3 seconds
Weight (with battery)	11 lb. (without tool/hose pack)

Dimensions	13.77" L x 7.28" W x 5.12" D
Temperature range	-4° to 122° F

#### Tool Head Assembly

Press force	3372 lb.
Weight (tool only)	1.65 lb.
Diameter of handle	1.61 in.
Length of handle	8.86 in.
Length of hose	7.22 ft.

#### Battery

Type	NiCd 12 V, rechargeable
Recharging time	15 min.
Number of recharges	1000

## Power Operated Installing Tools

There's a portable crimping tool that is designed to reduce the stress traditional hand tools put on wrist muscles.

Thomas & Betts ERG 3000 uses battery-powered hydraulics instead of muscle power to install Dragon Tooth terminals safely and securely.

In addition, our power crimping tool is engineered to substantially reduce the weight in the tool head, which is in the user's hand, to further reduce fatigue.

Because the ERG 3000 is constructed with the battery in the separate base unit, the tool head itself is very light and compact – enabling it to operate in tight quarters other power tools can't reach.

Because there is no manual or physical force required, the ERG 3000's ergonomic design dramatically reduces the risk of carpal tunnel syndrome that can occur with repetitive hand-crimping. And, by significantly reducing muscle fatigue, the ERG 3000 can lead to increased productivity over traditional hand crimping tools.

Tests conducted showed that the ERG 3000 increased productivity more than 50% when used in actual working situations.

## Short cycle times help speed work.

Depending on the size of the terminal being installed, the ERG 3000 has an exceptionally fast cycle time of just one to three seconds.

Add this to its ergonomic design and convenient portability, and you have a tool that makes installing Dragon Tooth connectors terminals faster and easier than ever.



## Standard Components

Cat. No.	Description	Wt. (lb.)
ERG-3001*	Base Unit	11.0
ERG-3002*	Hose & Tool Head Assembly	3.5
ERG-3003	NiCd Battery	1.3
ERG-3004	15 min. Battery Charge	3.0
ERG-3005	Carrying Case	6.3
ERG-3006	AC Adapter	7.0
ERG-3007	Benchmount	1.0
ERG-3008	Foot Switch	2.5
ERG-3000	Complete Kit (see note below)	26.4

\*Cannot be purchased separately.

## Dies for ERG-3000

Cat. No.	Description
ERG-86	Die Set for Non-insulated 8 and 6 AWG
ERG-86i	Die Set for Insulated 8 and 6 AWG
ERG-2214	Die Set for Non-insulated 22-14 AWG
ERG-2214i	Die Set for Insulated 22-14 AWG
ERG-1210	Die Set for Non-insulated 12-10 AWG
ERG-1210i	Die Set for Insulated 12-10 AWG

**Thomas & Betts**

# Sta-Kon®

## Application Tools

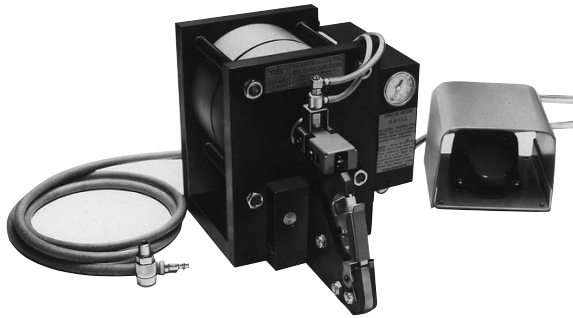

### Air Operated – Bench Mounted Tools

Cat. No.	Description	Std. Pkg.
25000	This compact heavy duty air tool installs nylon and TEFZEL® insulated Sta-Kon® terminals on wire sizes from 8 AWG to 250 MCM; non-insulated styles are also installed just as quickly and dependably; to crimp a terminal, you simply insert the stripped wire into the terminal barrel, position it in the crimping nest, and depress the foot pedal actuating the crimping dies – it's that easy	1

Tefzel® is a registered trademark of DuPont.

#### • Convenience and Economy

The tool accepts a full range of interchangeable dies, the same as used in the TBM6 or 6S tools. To install the dies, simply pull the spring-loaded pin and remove the indenter die. Then, flex the retaining spring and remove the die nest.

#### • Shure-Stake® Mechanism Means Quality Connections

The Shure-Stake® mechanism senses inlet air pressure, and if insufficient is designed to prevent the tool from cycling. Thus you avoid “undercrimping.” An 85-90 psi air pressure source is required.

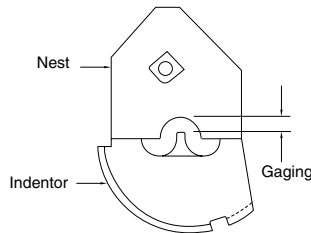

#### • Safety Features Increase Productivity, Reduce Downtime

Safety features include a guard over the die area, an air shutdown switch activated by a slight push with the finger, and an enclosed foot pedal designed to prevent unwanted tool operation. In addition, the tool may be bench mounted for stability and control. For convenience when crimping large size terminals on heavy wire, the head assembly may overhang the workbench.

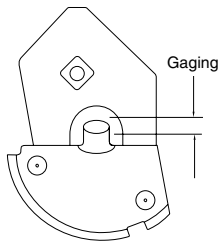

#### Installing Dies for Non-Insulated Code and Aircraft Sta-Kon® Terminals for 25000 tool

Cat. No. Nest Stationary Die	Cat. No. Indenter Movable Die	Term. Size	Gaging ±.010
11803		D	.152
11803		E	.152
11805		F	.167
11806	11802	G	.206
11807		H	.234
11808		J	.272
11809		K	.250
11810		L	.266
11811		M	.312

#### Installing Dies for Nylon Insulated Sta-Kon® Terminals for 25000 tool

Cat. No. Die Set	Term. Size	Gaging ±.010
11821	RD	.170
11822	RE	.202
11823	RF	.254
11824	RG	.321
11825	RH	.339
11826	RJ	.370
11827	RK	.382
11828	RL	.456
11829	RM	.554

K

Sta-Kon®

**Thomas & Betts**

# Sta-Kon®

## Application Tools



13500

*STA-KON® terminals, insulated and non-insulated #22 thru #10 wire range.*



11903A

### Air Operated – Bench Mounted Tools

Cat. No.	Description	Std. Pkg.
13500	Heavy duty, high speed production tool installs a wide range of Sta-Kon® terminals, from 26-10 gauge; uses the 100-1 air tool dies for both non-insulated and insulated terminals; is supplied complete with foot pedal, air hose-air/lubricator	1

### STA-KON® Installing Dies for 13500 Tool, 11901A–11904A

Die Cat. No.	Wire Range	Gaging	Type Crimp	Installs Term. Type
11951	10, 22 AWG	.062/.070, .081/.089, .106/.114	Double Indent	A, AA, AIA, B, BB BIB, C, CC, CIC
11958	–	.086/.096	Elliptical	RB4 Wire Joint
11959	–	.112/.120	Elliptical	RC6 Wire Joint
11960	–	.086/.096, 112/.120	Elliptical	RB4, RC6
11994	14, 22 AWG	.105/.109, 125/.129	Elliptical	RB, RB Nylon & Vinyl
11995	10, 12 AWG	.160/.166	Elliptical	RC Nylon & Vinyl

### Air Hydraulic Tool

Cat. No.	Description
11901A	Closed yoke; hand actuated
11902A	Closed yoke; foot actuated
11903A	Open "C" yoke; hand actuated
11904A	Open "C" yoke; foot actuated

Cat. Nos. 11902A and 11904A also require two (2) Cat. No. 11913 air hoses and one (1) Cat. No. 11930 foot valve.

Cat. Nos. 11901A and 11903A require one (1) Cat. No. 11913 air hose.

K

Sta-Kon®

**Thomas & Betts**

# Sta-Kon®

## Application Tools



### Twelve Ton Crimping Tool

Cat. No.	Description	Std. Pkg.
13400	Twelve ton crimping tool for installing both insulated and noninsulated Sta-Kon® terminals #8 to 250 MCM (dies ordered separately)	1

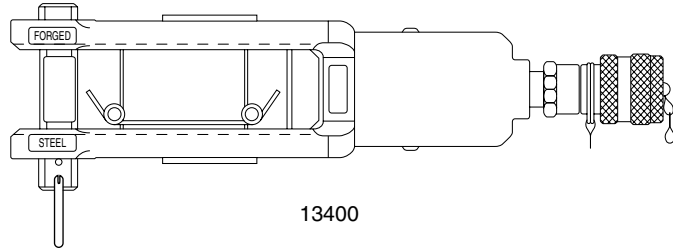

13400



### Twelve Ton Crimping Tool (Military Spec. MS25441-1)

Cat. No.	Description	Std. Pkg.
13642M	Hydraulic operated 12 to press installs "D" size through "M" size Sta-Kon® terminals on "AN" copper wire	1

13642M

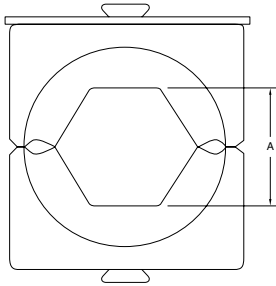

### Hex Dies for 13642M & 13400

Die Cat. No.					
For Tubular Term	For Brazed Seam	Sta-Kon® Size	Wire Size	Hex Die Code	A Gaging
11732	—	D	8	21	.197 ± .005
—	11733	—	—	24	.228 ± .005
11733	—	E	6	24	.228 ± .005
—	11734	—	—	29	.288 ± .005
11734	—	F	4	29	.288 ± .005
—	11735	—	—	33	.332 ± .005
11736	—	G	2-1	37	.376 ± .005
11737	—	H	1/0	42	.415 ± .005
11738	—	J	2/0	45	.453 ± .005
11739	—	K	3/0	50	.500 ± .005
11740	—	L	4/0	54	.544 ± .009
11771	—	M	250 MCM	62	.623 ± .004

### Hex Dies for 13642M (Military Listed)

Die Cat. No.	Sta-Kon® Size	Wire Size	A Gaging
11781M	D	8AN	.208 – .212
11782M	E	6AN	.238 – .242
11783M	F	4AN	.297 – .301
11784M	G	2AN	.375 – .379
11785M	H	1AN	.415 – .419
11786M	J	1/0AN	.454 – .458
11787M	K	2/0AN	.488 – .502
11788M	L	3/0AN	.560 – .564
11789M	M	4/0AN	.616 – .620

K

Sta-Kon®

# Sta-Kon®

## Installation Dies

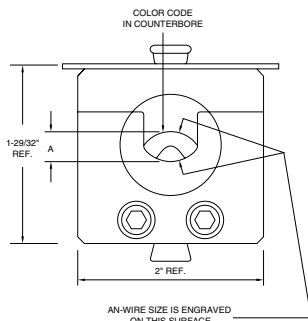

### Installing Dies for Insulated Terminals to fit 13642M (Military Listed)

Cat. No.	A Gaging
21707M	.168 – .172
21708M	.200 – .204
21709M	.252 – .256
21710M	.310 – .314
21711M	.337 – .341
21712M	.368 – .372
21713M	.406 – .402
21714M	.436 – .440
21715M	.471 – .475

### Gaging for Installing Dies Used to Install Flag Type Sta-Kon® Terminals – Use With 13642M & 13400

Nest Cat. No.	Indenter Cat. No.	Sta-Kon® Size	Gage Min.	Gage Max.
21733		8	.147	.153
21734	21731	6	.171	.177
21735		4	.194	.200
21736		2	.262	.269
21737		1	.278	.284
21738	21732	1/0	.309	.315
21739**		2/0	.356	.362
21740**		3/0	.382	.388
21741**		4/0	.434	.440

\*\* Cat. Nos. 21739, 21740 and 21741 dies must be left in 13642 head with 21732 indenter when gauging.

### Nest and Indenter for Installing One Piece – Non-insulated Terminals to Fit 13642M & 13400

Indenter Cat. No.	Nest Cat. No.	A Gaging	Terminal Series
13650	13654	.202-.210	G
13650	13655	.230-.238	H
13650	13656	.268-.276	J
13650	13657	.246-.254	K
13650	13658	.262-.270	L
13650	13659	.308-.316	M

### Nest and Indentors for Installing Sta-Kon® Brazed Seam Type Non-insulated Terminals to Fit 13642M & 13400

Nest Cat. No.	Indent. Cat. No.	Sta-Kon® Size	Code Wire	Dia.
13643		D	8	.153/.161
13644	13650	E	6	.183/.191
13645		F	4	.214/.222

K

Sta-Kon®

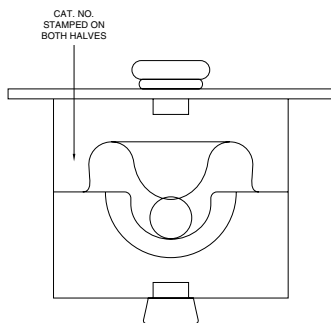

# Sta-Kon®

## Application Tools



13810A



13610A

### Electric Hydraulic Pump

Cat. No.	Description	Std. Pkg.
13810A	Electric hydraulic pump, 10000 psi with Shure-Stake® mechanism feature; this is a heavy duty OEM pump with high flow rate; 115V, 60Hz, 1½ HP, 23 Amps; requires hand or foot control	1
13611	Hand Switch for 13810A	1
13612	Foot Switch for 13810A	1
13613	High Pressure, steel reinforced hydraulic hose; 6 ft.	1
13614	High Pressure, steel reinforced hydraulic hose; 10 ft.	1
13619	High Pressure, plastic hydraulic hose; 10 ft.	1

**13600** This electric hydraulic pump is for use with all T&B hydraulic heads – consists of pump with pressure gage and Pioneer type male coupler; add suffix **WG** to eliminate gage; output pressure 9800 PSI; order switch and hose separately

**13620** Hand Switch – 10 ft

**13589A** Foot Switch – 10 ft

**13619** 10 ft. Non Metallic Hose

**13618** 20 ft. Non Metallic Hose

A remote control switch is required. Order Cat. No. 13620 for hand operation or Cat. No. 13589A for foot operation.

All pumps are supplied with a metal carrying case.

**13610A** Shure-Stake® electric hydraulic pump has same features as 13600, but includes the Shure-Stake® control mechanism; prevents under crimping; (pump pressure must reach 9,800 psi before recycling); requires hand or foot control; order switch and hose separately

**13611** Hand Switch – 10 ft

**13612** Foot Switch – 10 ft

**13797** In line hydraulic pressure inspection gage with male and female pioneer type coupler

A remote control switch is required to operate this unit. Use either a #13611 (hand) or #13612 (foot) switch.

**K**

Sta-Kon®

# Sta-Kon®

## Tool Charts

K

Sta-Kon®

Tool	Description	Terminal Series	Plier					Ratchet Ergonomic Hand Tools					Ratchet Hand Tool					12050 Die Numbers						11901A – 11904A 13500 Die Numbers							
			WT110M	WT111M	WT112M	WT161M	WT2000	ERG-2001	ERG-2002	ERG-2004	ERG-2005	WT1377	WT145A	WT145C	WT1452	WT465	WT1255	WT2130A	12051	12052	12054	12055	12056	12057	12058	12059	12060	11951	11958	11959	11960
Nylon Terminal	RZZ RA, RAX RB, RBC, RC				•		•	•			•	•	•			•		•		•										•	•
Nylon/Butt Splice	RA RB RC			•		•	•				•	•																	•	•	
Nylon/Parallel Splices	RAA RBB RCC					•																									
Nylon Disconnect/ Fully Insul. Disconnects (except 110 Disconnects)	RA RB RC			•		•	•				•	•				•		•		•									•	•	
Heat Shrinkable Nylon Terminal, Butt Splice, Disconnects	RAS RBS RCS													•	•																
Vinyl Terminal, Splices	RA, RAA RB, RBB RC, RCC, RBC			•		•	•				•	•				•			•		•								•	•	
Bare Terminal, Splices	A, AA B, BB C, CC	•	•	•	•	•		•		•											•		•			•					
Wire Joints	RB RC RP PT			•		•		•								•											•	•	•		
Hi-Temp Terminals	NW-Rings NW-Splice									•	•																				
Insulation Grip	A B	•	•																												
110 Disconnects	A, B RA, RB	•	•	•										•																	
Flag Terminal	AB C							•																							
Tefzel® Terminal	RAT, RBT, RCT			•								•																			
Vinyl Disconnects	RA RB RC			•		•	•				•	•				•			•		•								•	•	
Bare Disconnects	A B C	•	•	•	•	•		•	•		•										•		•			•					
Tefzel® Butt Splices	RAAT RBBT RCCT			•		•					•	•				•															

Tefzel® is a registered trademark of DuPont.



# Sta-Kon®

## Tool Charts

Description	Term.	Terminal	Hand Tool With Dies	25000 Air Tool		Hex Dies	13642M (MS25441-1) and 13400 Hydraulic Tool	
				Nest (Stationary)	Indentor (Movable)		Nest	Indentor
Non-Insulated Terminals and Splices	D	Tubular	ERG2005 WT3185	11803	11802	11781M*	13651	13650**
		Brazed	ERG2005 WT3185			11732	13652	
	E	Tubular	WT3185	11805		11733	13652	
		Brazed	ERG2005 WT3185			11782M*	13653	
	F	Tubular	WT3185	11806		11734	13653	
		Brazed	ERG2005 WT3185			11734	13653	
	G	Tubular	WT3185	11807		11783M*	13645	
	H	Tubular	WT3185	11808		11735	13654	
	J	Tubular	WT3185	11809		11784M*/11736	13654	
	K	Tubular		11810		11785M*	13655	
	L	Tubular		11811		11737	13656	
	M	Tubular				11786M*	13657	
					11738	13658		
					11787M*	13659		
					11739			
					11788M*			
					11740			
					11789M*			
					11771			
TEFZEL® Nylon Insulated Terminals and Splices	RD	Tubular	ERG2007	11821 (Set)	21707M* (Set)			
		Brazed						
	RE	Tubular	ERG2007	11822 (Set)	21708M* (Set)			
		Brazed						
	RF	Tubular		11823 (Set)	21709M* (Set)			
		Brazed						
	RG	Tubular		11824 (Set)	21710M* (Set)			
	RH	Tubular		11825 (Set)	21711M* (Set)			
	RJ	Tubular		11826 (Set)	21712M* (Set)			
	RK	Tubular		11827 (Set)	21713M* (Set)			
RL	Tubular		11828 (Set)	21714M* (Set)				
RM	Tubular		11829 (Set)	21715M* (Set)				
Non-Insulated Flag Terminals	D		WT129		21733	N E S T	I N D E N T O R	
	E		WT129		21734			21731
	F		WT129		21735			
	G		WT129		21736			
	H		WT129		21737			
	J				21738			
	K				21739			
	M				21740			
				21741				

\* Indicates military listed die.

\*\* To order the military version suffix the indentor catalog number with an **M** (13650M). Nest catalog number does not change.

Tefzel® is a registered trademark of DuPont.

### Stud Size and Clearance Hole Chart

Stud Size	2	4	6	8	10	¼	⅕	⅜	½	⅝	¾	
Min. hole diam. – in.	.092	.116	.143	.169	.196	.262	.323	.388	.453	.516	.650	.775
Min. hole diam. – mm.	2.337	2.946	3.632	4.292	4.978	6.655	8.204	9.855	11.506	13.106	16.510	19.685

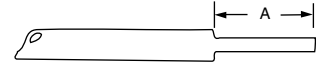

### Wire Strip Length Chart

Wire Strip Length	Terminal Series	Recommend Wire Strip Length "A" Standard Terminals
Non-Insulated	A	¼
	B	¼
	C, BC	⅝
Vinyl Insulated – Add ⅛" for Funnel Entry Type	RA	¼
	RB	¼
	RC, RBC	⅞
Nylon Insulated and Tefzel® Insulated	RA	⅜
	RB	⅜
	RC, RBC	⅝
Nylon Insulated and Tefzel® Insulated when using Aircraft and Code Wire	RD	⅞
	RE	⅞
	RF	⅝
	RG	⅞
	RH	⅞
	RJ	¾
	RK	⅞
	RL	⅞
	RM	1
Non-Insulated, when using Aircraft Code Wire	D	⅞
	E	⅞
	F	½
	G	⅞
	H	⅞
	J	⅞
	K	⅞
	L	⅞
	M	⅞

Tefzel® is a registered trademark of DuPont.

**K**

Sta-Kon®

# Sta-Kon®

## Wire Guide Tables

AWG or AN	Navy Shipboard <sup>3</sup>	Individual Strands		Whole Conductor		
		No.	diam.	cir.mil. area	diam.	diam. mm.
<b>22 Wire Size</b>						
22	3/5 (1)	1	.025	642	.025	.635
22	3/5 (7)	7	.010	703	.030	.762
AN-22*		7	*	704	.032	.813
	½ (21)	21	.005	525	.028	.711
<b>20 Wire Size</b>						
20	1 (1)	1	.032	1,022	.032	.813
20		7	.012	1,024	.036	.914
20		10	.010	1,005	.040	1.016
20		19	.007	1,022	.037	.940
20		26	.006	1,034	.039	.991
AN-20*		7	*	1,119	.040	1.016
	1 (7)	7	.013	1,119	.038	.965
	1 (10)	10	.010	1,005	.038	.965
	1 (26)	26	.006	1,034	.042	1.067
<b>18 Wire Size</b>						
18	1½ (1)	1	.040	1,624	.040	1.016
18	1½ (7)	7	.016	1,624	.049	1.245
18	1½ (16)	16	.010	1,608	.049	1.245
18		19	.009	1,624	.046	1.168
18	1½ (41)	41	.006	1,630	.049	1.245
AN-18*	2 (7)	7	.016	1,779	.048	1.219
<b>16 Wire Size</b>						
16	2½ (1)	1	.051	2,583	.051	1.295
16		7	.019	2,583	.058	1.473
16		19	.012	2,601	.058	1.473
16		26	.010	2,613	.059	1.499
16		65	.006	2,580	.058	1.473
AN-16*	2½ (19)	19	.011	2,407	.061	1.549
	2½ (26)	26	.010	2,613	.061	1.549
<b>14 Wire Size</b>						
14		1	.064	4,107	.064	1.626
14		7	.024	4,107	.073	1.854
14		19	.015	4,107	.074	1.880
14		37	.011	4,107	.074	1.880
14		14	.009	4,157	.083	2.108
14		104	.006	4,128	.074	1.880
AN-14*		19	*	3,830	.076	1.930
	3 (7)	7	.020	2,828	.060	1.524
	3 (19)	19	.013	3,036	.063	1.600
	4 (1)	1	.064	4,107	.064	1.626
	4 (7)	7	.025	4,497	.076	1.930
	4 (19)	19	.014	3,828	.072	1.829
	4 (41)	41	.010	4,121	.077	1.956
<b>12 Wire Size</b>						
12		1	.081	6,530	.081	2.057
12		7	.031	6,530	.092	2.337
12		19	.019	6,530	.093	2.362
12		37	.013	6,530	.093	2.362
12		49	.012	6,593	.104	2.642
12		65	.010	6,533	.093	2.362
12		104	.008	6,574	.094	2.388
12		165	.006	6,559	.095	2.413
AN-12*	6 (19)	19	.018	6,088	.096	2.438
	6 (7)	7	.031	6,512	.092	2.337
	6 (65)	65	.010	6,533	.097	2.964
<b>10 Wire Size</b>						
10		1	.102	10,380	.102	2.591
10		7	.039	10,380	.116	2.946
10		19	.023	10,380	.117	2.972
10		37	.017	10,443	.117	2.972
10		49	.015	10,445	.131	2.327
10		104	.010	10,452	.116	2.946
AN-10*		37	*	10,380	.117	2.972
	9 (7)	7	.036	9,016	.108	2.743
	9 (37)	37	.016	9,402	.109	2.769
	9 (90)	90	.010	9,045	.120	3.048

\* MIL-W-5086. 3 MIL-E-16366 A.

\* Strand diameter not specified.

**K**

Sta-Kon®

**Thomas & Betts**

# Sta-Kon®

## Wire Guide Tables

AWG or AN	Navy Shipboard <sup>3</sup>	Individual Strands		Whole Conductor		
		No.	diam.	cir.mil. area	diam.	diam. mm.
<b>9 Wire Size</b>						
9		7	.043	13,090	.130	3.302
	14 (7)	7	.045	14,340	.136	3.454
<b>8 Wire Size</b>						
8		7	.049	16,510	.146	3.712
8		19	.030	16,510	.148	3.763
8		37	.021	16,510	.148	3.763
<b>7 Wire Size</b>						
7		1	.144	20,820	.144	3.662
	14 (7)	7	.045	14,340	.136	3.454
	14 (140)	140	.010	14,070	.145	3.787
<b>6 Wire Size</b>						
6		7	.061	25,250	.184	4.672
6		19	.037	26,250	.186	4.722
6		37	.027	26,250	.186	4.722
6		49	.023	26,146	.208	5.283
6		661	.006	26,274	.259	6.579
<b>5 Wire Size</b>						
5		1	.181	33,100	.181	4.595
	20 (49)	7x7	.020	19,800	.180	4.570
	23 (7)	7	.057	22,800	.171	4.345
	23 (228)	19x12	.010	22,190	.190	4.830
	26 (49)	7x7	.023	26,250	.210	5.330
<b>4 Wire Size</b>						
4		7	.077	41,740	.232	5.891
4		19	.047	41,740	.235	5.967
4		37	.034	41,740	.235	5.967
<b>3 Wire Size</b>						
3		1	.229	52,630	.229	5.819
	30 (304)	19x16	.010	30,550	.220	5.590
	33 (336)	7x48	.010	33,370	.235	5.967
	40 (19)	19	.045	38,910	.226	5.742
	42 (49)	7x7	.029	41,740	.260	6.600
	42 (209)	19x11	.014	42,110	.260	6.600
	50 (19)	19	.051	49,080	.254	6.452
<b>2 Wire Size</b>						
2		7	.097	66,370	.292	7.421
2		19	.059	66,370	.296	7.522
2		37	.042	66,370	.297	7.548
2		49	.037	66,356	.331	8.405
2		133	.022	66,140	.335	8.507
AN-2*		663	*	66,832	.345	8.767
	53 (532)	19x28	.010	53,470	.304	7.772
	60 (37)	37	.040	60,090	.282	7.161
	60 (304)	19x16	.014	61,260	.310	7.870
	66 (133)	19x7	.022	66,370	.330	8.380
	75 (37)	37	.045	75,780	.317	8.048
<b>1 Wire Size</b>						
1		7	.109	83,690	.328	8.333
1		19	.066	83,690	.332	8.431
1		37	.048	83,690	.333	8.456
1		61	.037	83,690	.333	8.456
1		133	.025	83,690	.377	9.578
1		259	.018	83,916	.378	9.603
AN-1*		812	*	81,807	.384	9.752
	83 (418)	19x22	.014	84,230	.380	9.650
	84 (2107)	2107	*	83,690	.410	10.41

\* MIL-W-5086.

\* Strand diameter not specified.

3 MIL-E-16366 A

K

Sta-Kon®

**Thomas & Betts**

# Sta-Kon®

## Wire Guide Tables

AWG or AN	Navy Shipboard <sup>2</sup>	Individual Strands		Whole Conductor		
		No.	diam.	cir. mil. area	diam.	diam. mm.
<b>1/0 Wire Size</b>						
1/0		7	.123	105,500	.368	9.343
1/0		19	.075	105,500	.373	9.476
1/0		37	.053	105,500	.374	9.502
1/0		61	.042	105,500	.374	9.502
1/0		133	.028	105,761	.423	10.721
1/0		259	.020	105,672	.424	10.772
AN-0*		1033	*	104,118	.432	10.971
	100 (61)	61	.040	99,060	.363	9.216
	105 (259)	37x7	*	105,500	.410	10.410
<b>2/0 Wire Size</b>						
	105 (2646)	2646	*	105,500	.460	11.680
2/0		7	.138	133,100	.414	10.512
2/0		19	.084	133,100	.419	10.639
2/0		37	.060	133,100	.420	10.670
2/0		61	.047	133,100	.420	10.670
2/0		133	.032	132,800	.474	12.042
2/0		259	.023	133,462	.477	12.118
AN-00*		1327	*	133,665	.490	12.450
	125 (61)	61	.045	124,900	.407	10.338
	133 (259)	37x7	*	133,100	.460	11.680
	133 (684)	19x36	.014	137,800	.480	12.190
	133 (3325)	3325	*	133,100	.520	13.210
	150 (61)	61	.051	157,600	.457	11.608
<b>3/0 Wire Size</b>						
3/0		7	.155	167,800	.464	11.782
3/0		19	.094	167,800	.470	11.940
3/0		37	.067	167,800	.471	11.965
3/0		61	.052	167,800	.472	11.991
3/0		133	.036	167,607	.533	13.536
3/0		259	.026	167,402	.536	13.612
3/0		4227	.006	168,023	.610	15.490
	150 (760)	19x40	.014	153,100	.510	12.950
	168 (427)	61x7	*	167,800	.520	13.210
<b>4/0 Wire Size</b>						
4/0		7	.174	211,600	.522	13.261
4/0		19	.106	211,600	.528	13.413
4/0		37	.076	211,600	.529	13.439
4/0		61	.059	211,600	.530	13.460
4/0		133	.040	211,736	.599	15.219
4/0		259	.029	211,845	.601	15.265
AN-000*		1661	*	167,332	.548	13.923
	200 (61)	61	.057	198,700	.514	13.652
	200 (988)	19x52	.014	199,100	.580	14.730
<b>250 MCM Wire Size</b>						
250,000		19	.115	250,000	.574	14.582
250,000		37	.2	250,000	.575	14.607
250,000		61	.064	250,000	.576	14.632
250,000		91	.052	250,000	.576	14.632
AN-0000*		2104	*	211,954	.615	15.617
	220 (259)	37x7	.029	220,700	.610	15.490
	250 (61)	61	.064	250,000	.577	14.658

\* MIL-W-5086.

\* Strand diameter not specified.

3 MIL-E-16366 A.

**K**

Sta-Kon®

**Thomas & Betts**

## Terminals Military Standard Cross Reference

MIL-T-7928 MS-25036	T&B Cat. No. Class 1&2	MIL-T-7928 MS-20659	T&B Cat. No. Class 1&2	MIL-T-7928 MS-17143	T&B Cat. No.
-101	RA333	-101	A85G	-1	RA480
-102	RA853	-102	A87G	-2	RB480
-103	RA873	-103	B85G	-3	RC480
-104	RA723	-104	B87G	-4	RA481
-105	RA733	-105	C26	-5	RB481
-106	RB1333	-106	C70	-6	RC481
-107	RB853	-107	D10361	-7	RA482
-108	RB873	-108	D10721	-8	RB482
-109	RB723	-109	E10711	-9	RC482
-110	RB733	-110	E10731	-10	RA483
-111	RC333	-111	F10711	-11	RB483
-112	RC363	-112	F10731	-12	RC483
-113	RC703	-113	G971	-13	RA484
-114	RC733	-114	G973	-14	RB484
-115	RD10361	-115	H971	-15	RC484
-116	RD10711	-116	H973	-16	RA485
-117	RD10721	-117	J971	-17	RB485
-118	RD10731	-118	J973	-19	RA486
-119	RE10261	-119	K972	-20	RB486
-120	RE10711	-120	K973		
-121	RE10721	-121	L973		
-122	RE10731	-122	L975		
-123	RF10711	-123	M973		
-124	RF10721	-124	M975	-1	A486
-125	RF10731	-128	C73	-2	A483
-126	RG9711	-129	D10731	-3	A482
-127	RG9731	-130	E10261	-4	A481
-128	RG9751	-131	E10721	-5	A485
-129	RH9711	-132	F10721	-6	A484
-130	RH9731	-133	G975	-7	A480
-131	RH9751	-134	H975	-8	B486
-132	RJ9711	-135	J975	-9	B483
-133	RJ9731	-136	K975	-10	B482
-135	RK9721	-140	D10161	-11	B481
-136	RK9731	-141	D10711	-12	B485
-137	RK9751	-144	F10261	-13	B484
-138	RL9731	-146	G926	-14	B480
-139	RL9751	-147	G972	-15	C486
-140	RM9731	-148	G974	-16	C483
-141	RM9751	-149	H972	-17	C482
-142		-151	J972	-18	C481
-143	RAX23	-152	J974	-19	C485
-144	RAX43	-153	K971	-20	C484
-145	RAX63	-154	K974	-21	C480
-146	RAX83	-155	L972		
-147	RAX103	-156	L974		
-148	RA323	-157	M972		
-149	RA863	-158	M974		
-150	RA713	-165	C33	-8	21707M
-151	RA753	-166	C75	-6	21708M
-152	RB1323			-4	21709M
-153	RB863			-2	21710M
-154	RB713			-1	21711M
-155	RB753			-01	21712M
-156	RC863			-02	21713M
-157	RC713			-03	21714M
-158	RC753			-04	21715M
MIL-T-22909 MS-90485			T&B Cat. No.		T&B Cat. No.
		-8	11781M		
		-6	11782M		
		-4	11783M		
		-2	11784M		
		-1	11785M		
		-01	11786M		
		-02	11787M		
		-03	11788M		
		-04	11789M		
MIL-T-7928 MS-21004					T&B Cat. No.
				-1	A486
				-2	A483
				-3	A482
				-4	A481
				-5	A485
				-6	A484
				-7	A480
				-8	B486
				-9	B483
				-10	B482
				-11	B481
				-12	B485
				-13	B484
				-14	B480
				-15	C486
				-16	C483
				-17	C482
				-18	C481
				-19	C485
				-20	C484
				-21	C480
MIL-T-22909 -MS-23002					T&B Cat. No.
				-8	21707M
				-6	21708M
				-4	21709M
				-2	21710M
				-1	21711M
				-01	21712M
				-02	21713M
				-03	21714M
				-04	21715M



## Cross Reference for Packaging

Note: All catalog numbers do not appear in this cross reference. This means it may not be available in one of the package options.

T&B Distributor Package	T&B Bulk Package	T&B Distributor Package	T&B Bulk Package	T&B Distributor Package	T&B Bulk Package
A18-6	A85	C10-14	C71	RB14-8	RB863
A18-6F	A116	C10-14F	C116	RB14-8F	RB1123
A18-6FL	A221	C10-38	C73	RB14-8FL	RB2233
A18-8	A86	C10-250A	C252G	RB14-8FS	RB1223
A18-8F	A114	C10-250F	C250	RB14-8X	RB864
A18-8FL	A224	C10-516	C70	RB14-10	RB873
A18-10	A87	D8-10	D36	RB14-10F	RB1153
A18-10F	A115	D8-12	D75	RB14-10FL	RB2253
A18-10FL	A225	D8-14	D71	RB14-10FS	RB1253
A18-12	A75	D8-38	D73	RB14-10X	RB874
A18-14	A71	D8-516	D72	RB14-12	RB753
A18-38	A73	E6-10	E26	RB14-14	RB713
A18-110F	A10	E6-12	E75	RB14-14F	RB1163
A18-111F	A11	E6-14	E71	RB14-14X	RB714
A18-250	A250	E6-38	E73	RB14-38	RB733
A18-250A	A252G	E6-516	E72	RB14-38X	RB734
A18-251T	A251	F4-10	F26	RB14-47PT	RB147PT
A18-516	A72	F4-12	F75	RB14-110F	RB10
AB14-6A	AB51	F4-14	F71	RB14-111F	RB11
AB14-8A	AB52	F4-38	F73	RB14-250	RBB250
AB14-10A	AB53	F4-516	F72	RB14-250A	RB2577F
AD18-182	AD182	F250TA	FTA250	RB14-250F	RB250
AD18-183	AD183	G2-12	G975	RB14-250FP	RB250P
B14-D	B23	G2-14	G971	RB14-516	RB723
B14-4	B132	G2-38	G973	RB14-516X	RB724
B14-6	B133	G2-516	G972	RB44	RB4
B14-6F	B64	H10-14	H971	RBC14-14	RBC713
B14-6FL	B220	J20-38	J973	RBC14-516	RBC723
B14-6FS	B19	K30-38	K973	RBD14-182	RBD1823
B14-8	B86	L40-38	L973	RBD14-183	RBD1833
B14-8F	B65	M250-38	M973	RC10-6	RC333
B14-8FL	B223	NW14-6	NW81	RC10-6F	RC1113
B14-10	B87	NW14-10	NW83	RC10-6FL	RC2203
B14-10F	B115	NW14-12	NW84	RC10-8	RC863
B14-10FL	B225	NW22-10	NW23	RC10-8F	RC1123
B14-10G	B87G	RA18D	RA23	RC10-8FL	RC2213
B14-12	B75	RA18-4	RA323	RC10-8FS	RC1223
B14-14	B71	RA18-6	RA853	RC10-8X	RC864
B14-38	B73	RA18-6F	RA1103	RC10-10	RC363
B14-110F	B10	RA18-6FL	RA2213	RC10-10F	RC1153
B14-111F	B11	RA18-6FS	RA1203	RC10-10FL	RC2223
B14-250	B250	RA18-8	RA863	RC10-10FS	RC1253
B14-250A	B252G	RA18-8F	RA1123	RC10-10X	RC364
B14-250F	B250G	RA18-8FL	RA2243	RC10-12	RC753
B14-250T	B251G	RA18-8FS	RA1223	RC10-14	RC713
B14-251T	B251	RA18-10	RA873	RC10-14F	RC1163
B14-516	B72	RA18-10F	RA1153	RC10-14FL	RC2233
BC14-6	BC85	RA18-10FL	RA2253	RC10-14X	RC714
BC14-8	BC86	RA18-10FS	RA1253	RC10-38	RC733
BC14-10	BC87	RA18-12	RA753	RC10-38X	RC734
BC14-12	BC75	RA18-14	RA713	RC10-55PT	RC155PT
BC14-14	BC71	RA18-14F	RA1163	RC10-250A	RC2577F
BC14-38	BC79	RA18-38	RA733	RC10-250F	RC250
BC14-516	BC72	RA18-47PT	RA147PT	RC10-516	RC703
BD14-183	BD183	RA18-110F	RA10	RC55	RC6
C10-6	C33	RA18-111F	RA11	RD8-10	RD367
C10-6A	C51	RA18-250A	RA2577F	RD8-12	RD757
C10-6F	C133	RA18-250F	RA250	RD8-14	RD717
C10-6FL	C220	RA18-250FP	RA250P	RD8-38	RD737
C10-8	C77	RA18-516	RA723	RD8-516	RD727
C10-8A	C52	RAD18-182	RAD1823	RE6-10	RE267
C10-8F	C114	RAD18-183	RAD1833	RE6-12	RE757
C10-8FL	C221	RB14-4	RB1323	RE6-14	RE717
C10-10	C26	RB14-6	RB853	RE6-38	RE737
C10-10A	C53	RB14-6F	RB1113	RE6-516	RE727
C10-10F	C115	RB14-6FL	RB2213	RF4-10	RF267
C10-10FL	C222	RB14-6FS	RB1203	RF4-12	RF757
C10-12	C75	RB14-6X	RB854	RF4-14	RF717

**K**

Sta-Kon®

## Cross Reference for Packaging

T&B Distributor Package	T&B Bulk Package	T&B Distributor Package	T&B Bulk Package
RF4-38	RF737	14RB-6F	RB647
RF4-516	RF727	14RB-6FL	RB2207
RG2-10	RG267	14RB-6FLX	RB2207-200
RG2-12	RG757	14RB-6FX	RB647-200
RG2-14	RG717	14RB-6X	RB857-200
RG2-38	RG737	14RB-8	RB867
RG2-516	RG727	14RB-8F	RB657
RP12	RP7	14RB-8FL	RB2237
2A-18	AA2	14RB-8FLX	RB2237-200
2A20	RAA24	14RB-8FX	RB657-200
2A22-20	A1A	14RB-8X	RB867-200
2B-14	BB2	14RB-10	RB877
2B-16	RBB25	14RB-10F	RB1157
2B18-16	B1B	14RB-10FL	RB2257
2C-10	CC2	14RB-10FLX	RB2257-200
2C-12	RCC26	14RB-10FX	RB1157-200
2C14-12	C1C	14RB-10X	RB877-200
2D-8	DD102	14RB-14	RB717
2D10-9	D1D	14RB-14X	RB717-200
2E-6	EE2	14RB-38	RB737
2E8-7	E1E	14RB-47PT	RB47PT
2F-4	FF2	14RB-250F	RB257
2F6-5	F1F	14RB-250T	RB2517
2G21	GG2	14RB-251T	RB25177
2G4-2	G1G	14RB-516	RB727
2RAA	RAA23	14RB-2577	RB2573
2RA18	RAA21	14RBC-6	RBC857
2RA18X	RAA217-170	14RBC-8	RBC867
2RBB	RBB23	14RBC-10	RBC877
2RB14	RBB21	14RBC-14	RBC717
2RB14X	RBB217-200	14RBC-516	RBC727
2RCC	RCC23	14RBC-38	RBC797
2RC10	RCC21	14RBC-12	RBC757
2RC10X	RCC217-250	14RBD-182	RBD1827
2RD8	RDD27	14RBD-183	RBD1837
2RE6	REE28	14RBD-18277	RBD18277
10RC-6	RC337	14RBD-18377	RBD18377
10RC-6F	RC1337	18RA-4	RA77
10RC-6FL	RC2207	18RA-6	RA857
10RC-6FLX	RC2207-250	18RA-6F	RA1167
10RC-6X	RC337-250	18RA-6FL	RA2217
10RC-8	RC777	18RA-6FLX	RA2217-170
10RC-8F	RC1147	18RA-6FX	RA1167-170
10RC-8FL	RC2217	18RA-6X	RA857-170
10RC-8FLX	RC2217-250	18RA-8	RA867
10RC-8X	RC777-250	18RA-8F	RA1147
10RC-10	RC367	18RA-8FL	RA2247
10RC-10F	RC1157	18RA-8FX	RA1147-170
10RC-10FL	RC2227	18RA-8X	RA867-170
10RC-10FLX	RC2227-250	18RA-10	RA877
10RC-10FX	RC1157-250	18RA-10F	RA1157
10RC-10X	RC367-250	18RA-10FL	RA2257
10RC-14	RC717	18RA-10FLX	RA2257-170
10RC-14F	RC1167	18RA-14	RA717
10RC-14FL	RC2237	18RA-38	RA737
10RC-14X	RC717-250	18RA-47PT	RA47PT
10RC-38	RC737	18RA-250F	RA257
10RC-38X	RC737-250	18RA-250T	RA2517
10RC-55PT	RC55PT	18RA-251T	RA25177
10RC-250F	RC257	18RA-516	RA727
10RC-250T	RC2517	18RA-516X	RA727-170
10RC-251T	RC25177	18RA-2577	RA2573
10RC-516	RC707	18RAD-182	RAD1827
10RC-2577	RC2573	18RAD-183	RAD1837
14RB-4	RB1327	18RAD-18277	RAD18277
14RB-6	RB857	18RAD-18377	RAD18377

**K**

Sta-Kon®



## Cross Reference for Packaging

T&B Bulk Package	T&B Distributor Package	T&B Bulk Package	T&B Distributor Package	T&B Bulk Package	T&B Distributor Package
A10	A18-110F	C115	C1010F	RA867-170	18RA-8X
A11	A18-111F	C116	C10-14F	RA873	RA18-10
A115	A18-10F	C133	C10-6F	RA877	18RA-10
A71	A18-14	C220	C10-6FL	RA877-170	18RA-10X
A71F	A18-14F	C221	C10-8FL	RA1103	RA18-6F
A75	A18-12	C222	C10-10FL	RA1123	RA18-8F
A85	A18-6	C250	C10-250F	RA1147	18RA-8F
A86	A18-8	C252G	C10-250A	RA1147-170	18RA-8FX
A87	A18-10	C1C	2C14-12	RA1153	RA18-10F
A114	A18-8F	CC2	2C10	RA1157	18RA-10F
A115	A18-10F	D36	D8-10	RA1163	RA18-14F
A116	A18-6F	D71	D8-14	RA1167	18RA-6F
A221	A18-6FL	D72	D8-516	RA1167-170	18RA-6FX
A224	A18-8FL	D73	D8-38	RA1203	RA18-6FS
A225	A18-10FL	D75	D8-12	RA1223	RA18-8FS
A250	A18-250	D1D	2D10-9	RA1253	RA18-10FS
A251	A18-251T	DD102	2D8	RA2213	RA18-6FL
A252G	A18-250A	E26	E6-10	RA2217	18RA-6FL
A1A	2A22-20	E71	E6-14	RA2217-170	18RA-6FLX
AA2	2A18	E72	E6-516	RA2243	RA18-8FL
AB51	AB14-6A	E73	E6-38	RA2247	18RA-8FL
AB52	AB14-8A	E75	E6-12	RA2253	RA18-10FL
AB53	AB14-10A	E1E	2E8-7	RA2257	18RA-10FL
AD182	AD18-182	EE2	2E6	RA2257-170	18RA-10FLX
AD183	AD18-183	F26	F4-10	RA2517	18RA-250T
B10	B14-110F	F71	F4-14	RA2573	18RA-257T
B11	B14-111F	F72	F4-516	RA2577F	RA18-250A
B23	B14-D	F73	F4-38	RA25177	18RA-251T
B64	B14-6F	F75	F4-12	RAA21	2RA18
B65	B14-8F	F1F	2F6-5	RAA23	2RAA
B71	B14-14	FF2	2F4	RAA24	2A20
B72	B14-516	FTA250	F250-TA	RAA217-170	2RA18X
B73	B14-38	G971	G2-14	RAD1823	RAD18-182
B75	B14-12	G972	G2-516	RAD1827	18RAD-182
B133	B14-6	G973	G2-38	RAD1833	RAD18-183
B86	B14-8	G975	G2-12	RAD1837	18RAD-183
B87	B14-10	G1G	2G4-2	RAD1887F	RAD18-188A
B87G	B14-10G	GG2	2G21	RAD18277	18RAD18277
B115	B14-10F	H971	H10-14	RAD18377	18RAD18377
B132	B14-4	J973	J20-38	RB4	RB44
B220	B14-6FL	K973	K30-38	RB10	RB14-110F
B223	B14-8FL	L973	L40-38	RB11	RB14-111F
B225	B14-10FL	M973	M250-38	RB23	RB14-D
B250	B14-250	NW23	NW22-10	RB47PT	14RB-47PT
B250G	B14-250F	NW83	NW14-10	RB197	14RB-6FS
B251	B14-251T	NW84	NW14-12	RB147PT	RB14-47PT
B251G	B14-250T	RA10	RA18-110F	RB250	RB14-250F
B252G	B14-250A	RA11	RA18-111F	RB250P	RB14-250FP
B1B	2B18-16	RA23	RA18-D	RB257	14RB-250F
BB2	2B14	RA47PT	18RA-47PT	RB647	14RB-6F
BC71	BC14-14	RA77	18RA-4	RB647-200	14RB-6FX
BC72	BC14-516	RA147PT	RA18-47PT	RB657	14RB-8F
BC75	BC14-12	RA250	RA18-250F	RB657-200	14RB-8FX
BC79	BC14-38	RA250P	RA18-250FP	RB713	RB14-14
BC85	BC14-6	RA257	18RA-250F	RB714	RB14-14X
BC86	BC14-8	RA323	RA18-4	RB717	14RB-14
BC87	BC14-10	RA713	RA18-14	RB717-200	14RB-14X
BD183	BD14-183	RA717	18RA-14	RB723	RB14-516
C26	C10-10	RA723	RA18-516	RB724	RB14-516X
C33	C10-6	RA727	18RA-516	RB727	14RB-516
C52	C10-8A	RA733	RA18-38	RB733	RB14-38
C53	C10-10	RA737	18RA-38	RB734	RB14-38X
AC70	C10-516	RA753	RA18-12	RB737	14RB-38
C71	C10-14	RA853	RA18-6	RB753	RB14-12
C73	C10-38	RA857	18RA-6	RB853	RB14-6
C75	C10-12	RA857-170	18RA-6X	RB854	RB14-6X
C77	C10-8	RA863	RA18-8	RB857	14RB-6
C114	C10-8F	RA867	18RA-8	RB857-200	14RB-6X

## Cross Reference for Packaging

T&B Bulk Package	T&B Distributor Package	T&B Bulk Package	T&B Distributor Package
RB863	RB14-8	RC713	RC10-14
RB864	RB14-8X	RC714	RC10-14X
RB867	14RB-8	RC717	10RC-14
RB867-200	14RB-8X	RC717-250	10RC-14X
RB873	RB14-10	RC733	RC10-38
RB874	RB14-10X	RC734	RC10-38X
RB877	14RB-10	RC737	10RC-38
RB877-200	14RB-10X	RC737-250	10RC-38X
RB1113	RB14-6F	RC753	RC10-12
RB1123	RB14-8F	RC777	10RC-8
RB1153	RB14-10F	RC777-250	10RC-8X
RB1157	14RB-10F	RC863	RC10-8
RB1157-200	14RB-10FX	RC864	RC10-8X
RB1163	RB14-14F	RC1113	RC10-6F
RB1203	RB14-6FS	RC1123	RC10-8F
RB1223	RB14-8FS	RC1147	10RC-8F
RB1253	RB14-10FS	RC1153	RC10-10F
RB1323	RB14-4	RC1157	10RC-10F
RB1327	14RB-4	RC1157-250	10RC-10FX
RB2207	14RB-6FL	RC1163	RC10-14F
RB2207-200	14RB-6FLX	RC1223	RC10-8FS
RB2213	RB14-6FL	RC1253	RC10-10FS
RB2233	RB14-8FL	RC1337	10RC-6F
RB2237	14RB-8FL	RC2203	RC10-6FL
RB2237-200	14RB-8FLX	RC2207	10RC-6FL
RB2253	RB14-10FL	RC2207-250	10RC-6FLX
RB2257	14RB-10FL	RC2213	RC10-8FL
RB2257-200	14RB-10FLX	RC2217	10RC-8FL
RB2517	14RB-250T	RC2217-250	10RC-8FLX
RB2573	14RB-2577	RC2223	RC10-10FL
RB2577F	RB14-250A	RC2227	10RC-10FL
RB25177	14RB-251T	RC2227-250	10RC-10FLX
RBB21	2RB14	RC2233	RC10-14FL
RBB23	2RBB	RC2237	10RC-14FL
RBB25	2B16	RC2517	10RC-250T
RBB217-200	2RB14X	RC2573	10RC-2577
RBB250	RB14-250	RC2577F	RC10-250A
RBC713	RBC14-14	RC25177	10RC-251T
RBC717	14RBC-14	RCC21	2RC10
RBC723	RBC14-516	RCC23	2RCC
RBC727	14RBC-516	RCC26	2C12
RBC757	14RBC-12	RCC217-250	2RC10X
RBC797	14RBC-38	RD367	RD8-10
RBC857	14RBC-6	RD717	RD8-14
RBC867	14RBC-8	RD727	RD8-516
RBC877	14RBC-10	RD737	RD8-38
RBD1823	RBD14-182	RD757	RD8-12
RBD1827	14RBD-182	RDD27	2RD8
RBD1833	RBD14-183	RE267	RE6-10
RBD1837	14RBD-183	RE717	RE6-14
RBD18277	14RBD-18277	RE727	RE6-516
RBD18377	14RBD-18377	RE737	RE6-38
RC6	RC55	RE757	RE6-12
RC55PT	10RC-55PT	REE28	2RE6
RC155PT	RC10-55PT	RF267	RF4-10
RC250	RC10-250F	RF717	RF4-14
RC257	10RC-250F	RF727	RF4-516
RC333	RC10-6	RF737	RF4-38
RC337	10RC-6	RFF29	2RF4
RC337-250	10RC-6X	RG267	RG2-10
RC363	RC10-10	RG717	RG2-14
RC364	RC10-10X	RG727	RG2-516
RC367	10RC-10	RG737	RG2-38
RC367-250	10RC-10X	RG757	RG2-12
RC703	RC10-516	RP7	RP12
RC707	10RC-516		

**K**

Sta-Kon®