

THIS DRAWING IS UNPUBLISHED. RELEASED FOR PUBLICATION
 © COPYRIGHT - By - ALL RIGHTS RESERVED.

LOC	DIST	REVISIONS					
AD	0	P	LTR	DESCRIPTION	DATE	DWN	APVD
			E2	REVISED PER ECO-14-014370	23SEP2014	NK	RH

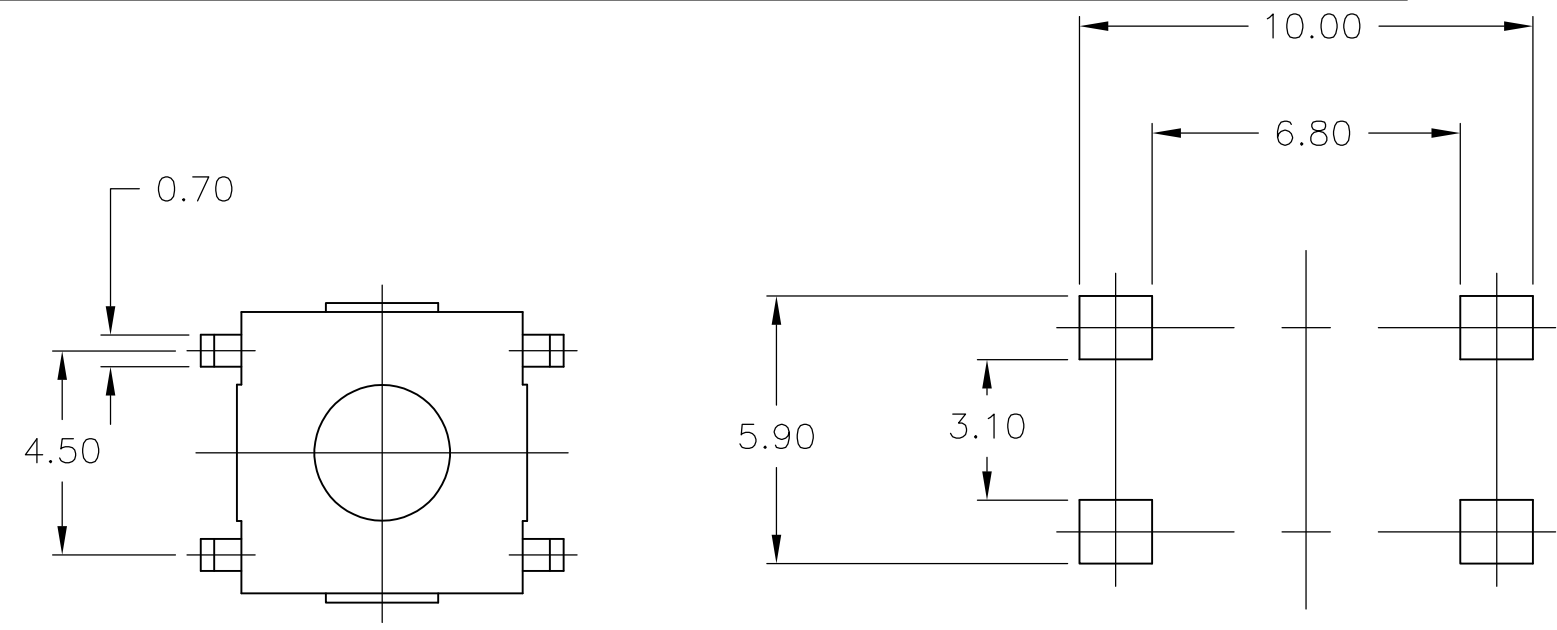

P C B LAND DIMENSION

MATERIALS:
 CASE: PPS, 94V-0, BLACK
 COVER: COPPER ALLOY, TIN PLATE
 ACTUATOR: NYLON 6T UL94V-0, COLOR- RED
 MOVING CONTACT: COPPER ALLOY, SILVER FINISH
 FIXED CONTACT/TERMINAL: COPPER ALLOY, SILVER FINISH

ELECTRICAL:
 MAX CONTACT RATING: 50MILLIAMPS@24V DC
 MIN CONTACT RATING: 10MICROAMPS@1V DC
 INITIAL CONTACT RESISTANCE: 100 MILLIOHMS MAX
 INSULATION RESISTANCE: 100 MEGOHMS AT 250 VDC MIN
 DIELECTRIC STRENGTH: 500 VAC 50/60 HZ FOR 1 MINUTE.
 LIFE EXPECTANCY: 100,000 CYCLES MIN.

MECHANICAL:
 ACTUATION FORCE: 260±30g
 ACTUATION TRAVEL 0.25^{+0.2}_{-0.1}
 LIFE EXPECTANCY: 150,000 CYCLES

ENVIRONMENTAL:
 OPERATING TEMPERATURE: -35°C TO +85°C
 STORAGE TEMPERATURE: -35°C TO +85°C
 RESISTANCE TO SOLDER HEAT PER 109-201 COND B.

- NOTES:**
- TAPE AND REEL PACKAGING PER EIA-481, PITCH 12MM, WIDTH 16MM. 1500 PCS. PER REEL.
 - ALL MATERIALS AND FINISHES SHALL COMPLY WITH EU DIRECTIVE 2002/95/EC OF 27JAN2003 (ROHS)

() - INDICATES MOMENTARY POSITION

CIRCUIT CHARACTERISTICS		
CONTACT POSITION		CIRCUIT DIAGRAM
OFF		
(ON)		

FSM4LPA	1571621-1
FSM4LPATR	4-1437565-3
OLD T&B P/N	PART NUMBER

THIS DRAWING IS A CONTROLLED DOCUMENT.		DWN	M.BINNER	17SEP02	TE Connectivity NAME TACTILE SWITCH 6X6mm LOW PROFILE, SURFACE MOUNT	SIZE	CAGE CODE	DRAWING NO	RESTRICTED TO	
DIMENSIONS: mm		CHK	M.SARVER	18SEP02		PRODUCT SPEC	—	—	—	—
TOLERANCES UNLESS OTHERWISE SPECIFIED:		APVD	M.SARVER	18SEP02		APPLICATION SPEC	—	—	—	—
0 PLC ± - 1 PLC ± - 2 PLC ± 0.30 3 PLC ± - 4 PLC ± - ANGLES ± -		WEIGHT	—			—	—	—	—	—
MATERIAL		FINISH		—		A300779		C-4-1437565-3		
—		—		—		CUSTOMER DRAWING		SCALE	6:1	
—		—		—		SHEET		1 OF 2		
—		—		—		REV		E2		

P	LTR	DESCRIPTION	DATE	DWN	APVD
-	-	SEE SHEET 1	-	-	-

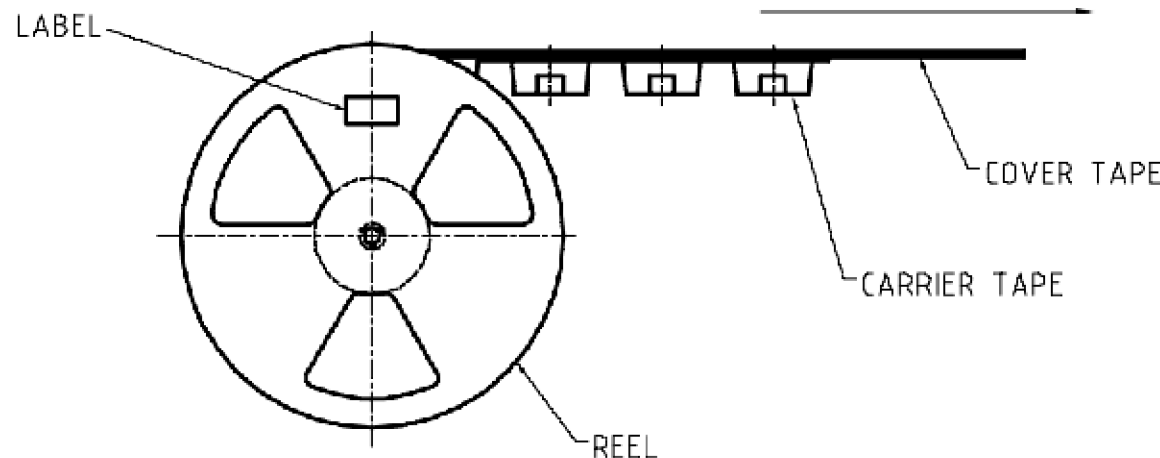
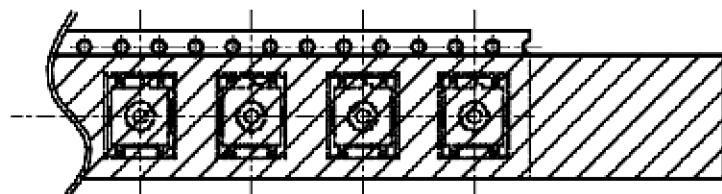
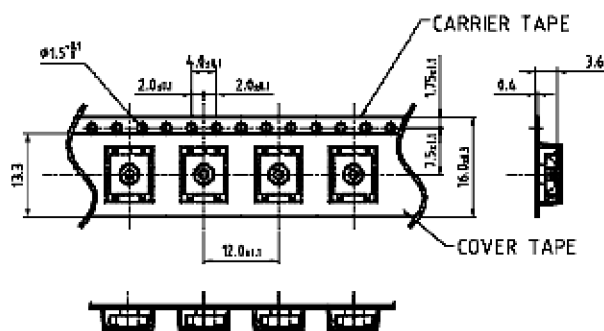

-THE DIRECTION OF PILOT HOLES-

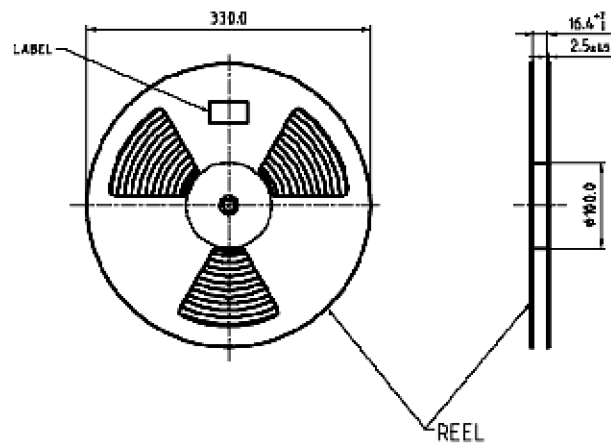

-THE DIMENSION OF CARRIER TAPE, COVER TAPE AND REEL-

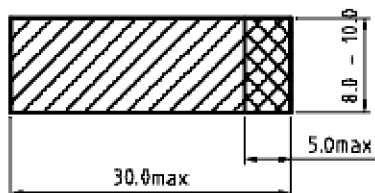
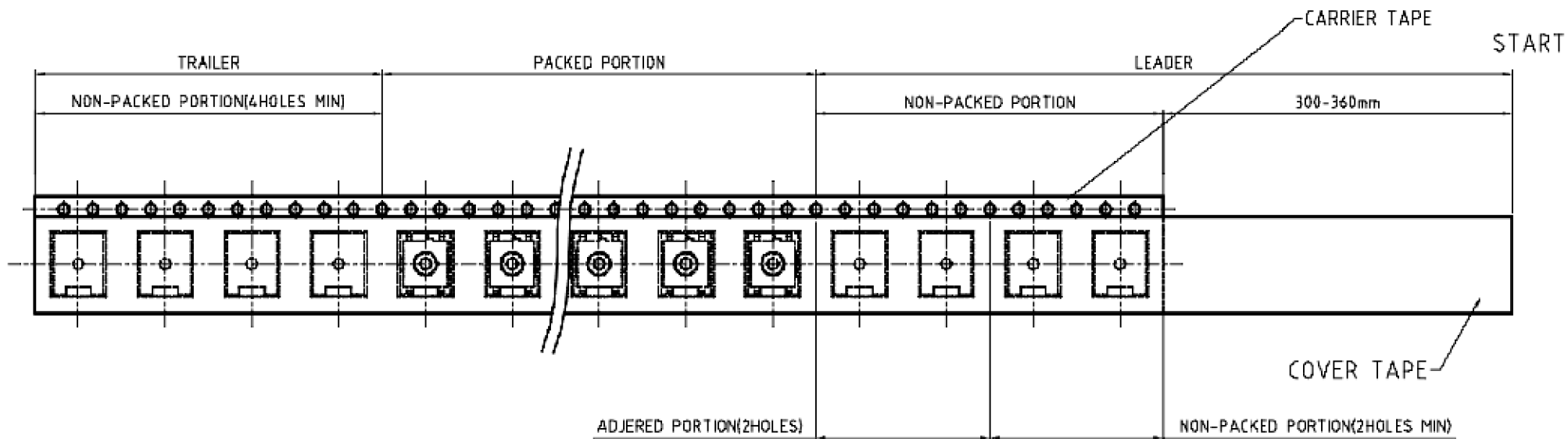
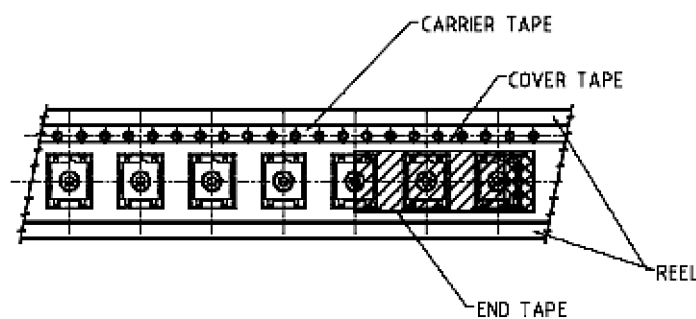

THIS DRAWING IS A CONTROLLED DOCUMENT.		DWN	M.BINNER	17SEP02		TE Connectivity			
DIMENSIONS:		CHK	M.SARVER	18SEP02		NAME			
mm		APVD	M.SARVER	18SEP02		TACTILE SWITCH 6X6mm LOW PROFILE, SURFACE MOUNT			
TOLERANCES UNLESS OTHERWISE SPECIFIED:		PRODUCT SPEC	-			APPLICATION SPEC			
0 PLC ± -		APVD	-			-			
1 PLC ± -		PRODUCT SPEC	-			-			
2 PLC ± 0.30		APPLICATION SPEC	-			-			
3 PLC ± -		APPLICATION SPEC	-			-			
4 PLC ± -		APPLICATION SPEC	-			-			
ANGLES ± -		APPLICATION SPEC	-			-			
FINISH		WEIGHT	-			SIZE	CAGE CODE	DRAWING NO	RESTRICTED TO
-		-			A3	00779	C-4-1437565-3	-	
MATERIAL		CUSTOMER DRAWING			SCALE	SHEET	REV		
-		-			6:1	2 OF 2	E2		