

FP0 Series Programmable Controllers

FP0 – Super Compact PLC

Incredibly Small, Alone or Even as Multiple Combined Units

From I/O 10-points...

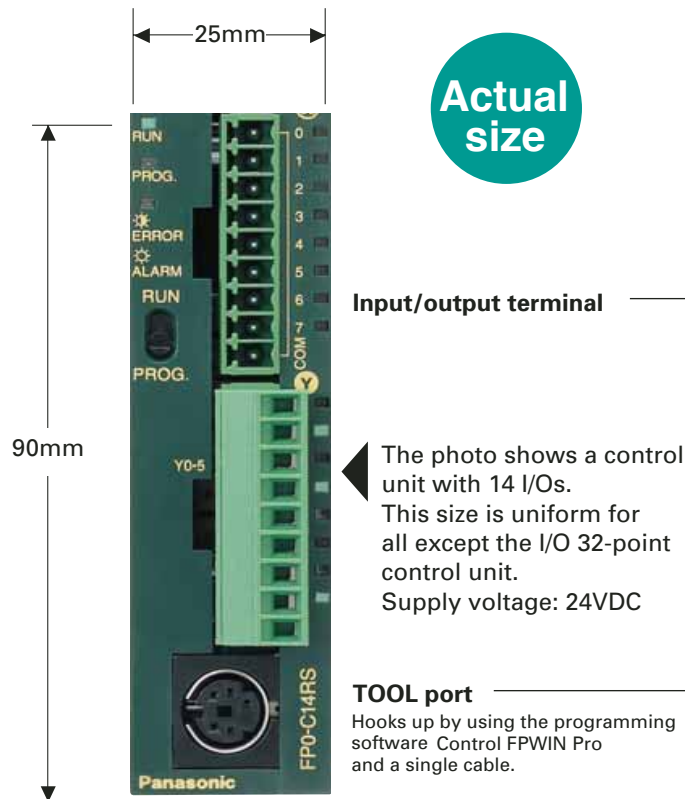

COM port: 2nd RS232C interface
(optional for all CPU units for serial communication)

Compact size

A control unit a mere 25mm* in width. Even expanded to 128 I/O points, the width is still only 105mm. The attachment area is one of the smallest in its class.

The FP0 offers a compact design that breaks all previous common sense rules on small-scale PLCs. With one of the smallest-ever attachment areas, the FP0 is perfect for installation in machines, facilities, and control boards where miniaturization is progressing even further.

*30mm width for control units with 32 I/Os.

Choose among 3 types of attachment



DIN rail



Slim attachment plate model



Flat attachment plate model (cannot be used with expansions)

Either 10 Points or the Maximum of 128 Points

You Save This Much Space!

...up to 128 I/Os

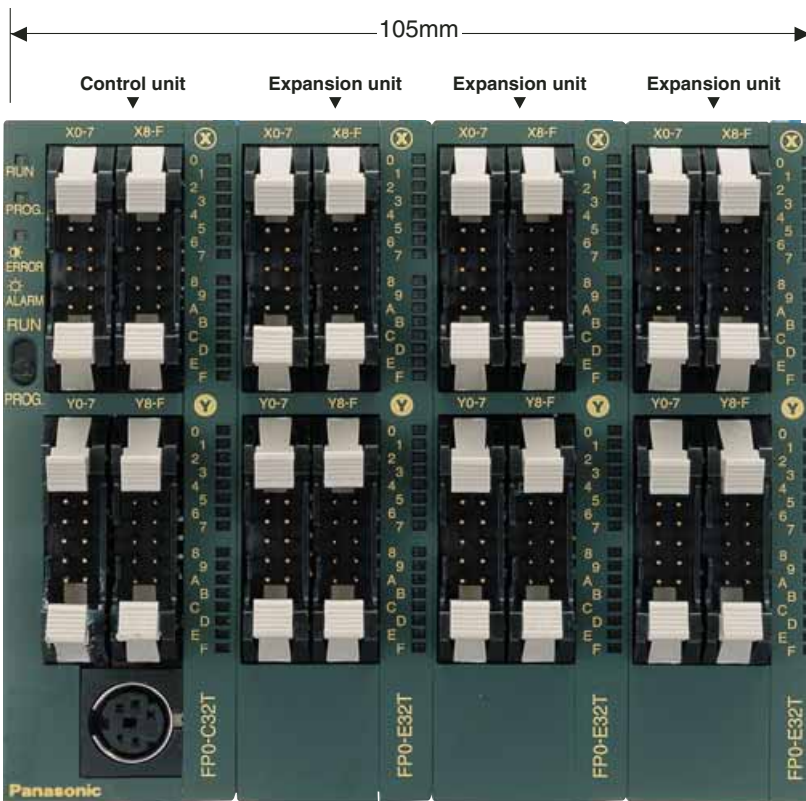

■ Networking:

- ETHERNET
- Modbus
- PROFIBUS
- S-LINK
- MEWNET-F

■ Analogue modules featuring different numbers of input and output channels

■ Programming software:

- Control FPWIN Pro according to IEC 61131-3
- Control FPWIN GR easy, conventional programming

◀ The photo illustrates adding three 32-point I/O expansion units to an 32-point I/O control unit, yielding 128 points.

Supply voltage 24VDC.

Easy expansion

The expansion unit can be attached easily without any cables.

The expansion unit can easily be attached directly to the control unit. Special expansion cables, backplanes and so forth are unnecessary as the expansion unit employs a stacking system that uses expansion connectors and locking levers on the surface of the unit itself.

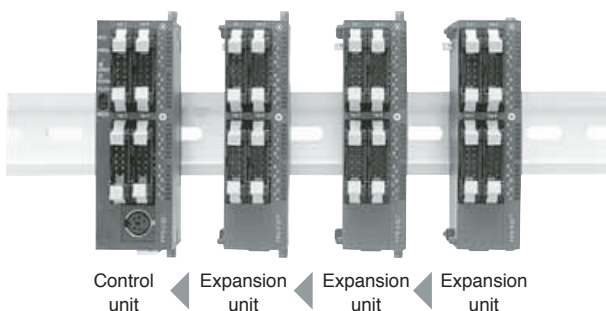

(Maximum possible expansion is three units)

Because of its super compact size and high capabilities, the units are useful in a wide variety of applications.

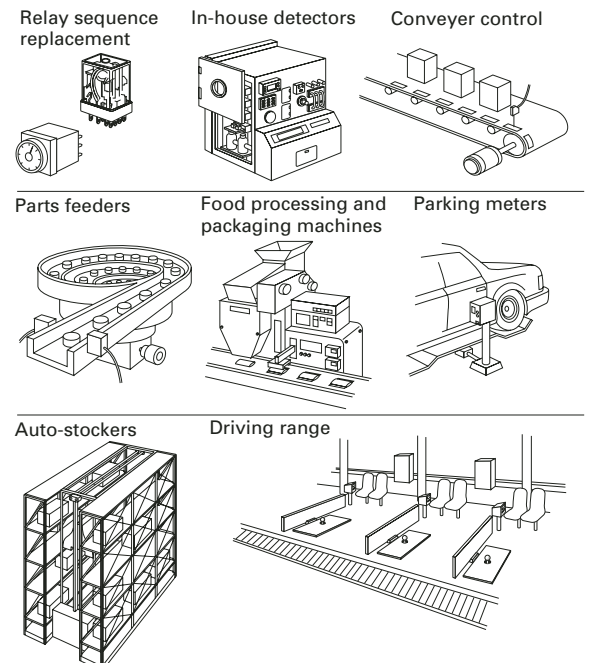

FP0 CPU Units

A Rich Line-Up of Both Single and Combined Units

Control units

Relay output type



10 points	
Input 6 points	Output 4 points
FP0-C10RSA	



10 points	
Input 6 points	Output 4 points
FP0-C10CRSA	
with 2nd RS232C	



14 points	
Input 8 points	Output 6 points
FP0-C14RSA	



14 points	
Input 8 points	Output 6 points
FP0-C14CRSA	
with 2nd RS232C	



16 points	
Input 8 points	Output 8 points
FP0-C16PA (PNP)	
FP0-C16TA (NPN)	



16 points	
Input 8 points	Output 8 points
FP0-C16CPA (PNP)	
FP0-C16CTA (NPN)	
with 2nd RS232C	



32 points	
Input 16 points	Output 16 points
FP0-C32PA (PNP)	
FP0-C32TA (NPN)	



32 points	
Input 16 points	Output 16 points
FP0-C32CPA (PNP)	
FP0-C32CTA (NPN)	
with 2nd RS232C	

Control unit 10k

FP0-T32C



32 points	
Input 16 points	Output 16 points
FP0-T32CPA (PNP)	

FP0-T32CTA (NPN)
with 2nd RS232C

This advanced FP0 CPU offers additional features:

- 10,000 steps program memory
- Battery backed RAM
- Real-time clock
- 16383-word data register

AC power supply

FP0-PSA2



Input 85 to 265VAC	Output 24VDC/0.7A
Terminal type	

Expansion combinations

A maximum of 3 expansion units can be added to the control unit. (Combining relay output types and transistor output types is also possible. In this event, the maximum number of I/O points when using a relay output type control panel is 110.)

Combinations with transistor output type – Examples

(Total number of I/O points)	=	(Control unit)	+	(Expansion unit 1)	+	(Expansion unit 2)	+	(Expansion unit 3)
48 Input 24 Output 24	=	32 Input 16 Output 16	+	16 Input 8 Output 8	+		+	
	=	16 Input 8 Output 8	+	32 Input 16 Output 16	+		+	
64 Input 32 Output 32	=	32 Input 16 Output 16	+	32 Input 16 Output 16	+		+	
8 Input 40 Output 40	=	32 Input 16 Output 16	+	32 Input 16 Output 16	+	16 Input 8 Output 8	+	
	=	16 Input 8 Output 8	+	32 Input 16 Output 16	+	32 Input 16 Output 16	+	
96 Input 48 Output 48	=	32 Input 16 Output 16	+	32 Input 16 Output 16	+	32 Input 16 Output 16	+	
	=	16 Input 8 Output 8	+	32 Input 16 Output 16	+	32 Input 16 Output 16	+	16 Input 8 Output 8
112 Input 56 Output 56	=	32 Input 16 Output 16	+	32 Input 16 Output 16	+	32 Input 16 Output 16	+	16 Input 8 Output 8
128 Input 64 Output 64	=	32 Input 16 Output 16	+	32 Input 16 Output 16	+	32 Input 16 Output 16	+	32 Input 16 Output 16

FPO Expansion Units

Choose the Number of I/O Points to Suit the Application

Digital I/O units

Relay output type



8 points
Input 4 points Output 4 points
FP0-E8RSA



16 points
Input 8 points Output 8 points
FP0-E16RSA



32 points
Input 16 points Output 16 points
FP0-E32RS



8 points
Input 8 points
FP0-E8XA



16 points
Input 16 points
FP0-E16XA



8 points
Output 8 points
FP0-E8YPA (PNP)
FP0-E8YTA (NPN)



16 points
Input 8 points Output 8 points
FP0-E16YPA (PNP)
FP0-E16YTA (NPN)



16 points
Output 16 points
FP0-E16YPA (PNP)
FP0-E16YTA (NPN)



32 points
Input 16 points Output 16 points
FP0-E32YPA (PNP)
FP0-E32YTA (NPN)

Option:

Output 8 points
FP0-E8YRSA

Input only type

Transistor output type

Analogue I/O units



3 points
Input 2 points Output 1 points
FP0-A21A



4 points
Output 4 points
FP0-A04I



4 points
Output 4 points
FP0-A04V



8 points
Input 8 points
FP0-A80A

- Input (12-bit): $\pm 10V, 0 - 5V, 0 - 20mA$
- Output (12-bit): $\pm 10V, 0 - 20mA$

4 - 20mA

$\pm 10V$

- $\pm 10V, \pm 100mV$
- $0 - 5V, 0 - 20mA$

-

Thermocouple and RTD units



4 points
Input 4 points
FP0-TC4



8 points
Input 8 points
FP0-TC8



6 points
Input 6 points
FP0-RTD6

- K, J, T, R type thermocouples can be used
- Resolution: 0.1°C
- Accuracy: 0.8°C (R type: 3°C)
- Temperature range: -100 to 1500°C

- Pt100, Pt1000, Ni1000
- Temperature range: -200 to 500°C

Networking units



**MEWNET-F
FP0-IOL**
(MEWNET-F Slave)



**S-LINK CPU
FP0-SL1**
(S-LINK Master)



**ETHERNET
FP WEB D**
(Web-Server Unit)



**PROFIBUS
FP0-DPS2**
(DP Slave)



FPO – Impressive Capabilities

High Specifications for Both Speed and Capacity

0.9µs per basic instruction. Pulse catch and interrupt input functions meet the need for high-speed response.

High-speed execution

Execution speed of 0.9µs per basic instruction. 500 step programme yields a scanning time of 1ms.

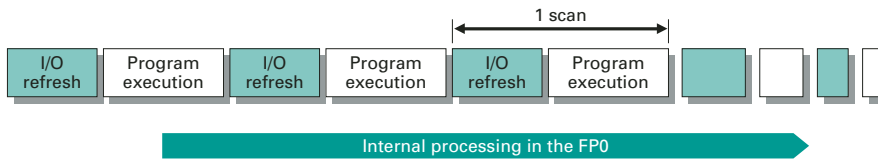

Internal processing in the FPO

Pulse catch function

Can read pulses as short as 50µs, which facilitates sensor input.

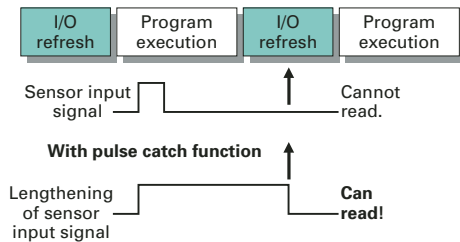

Pulse catch function

Interrupt input function

Accurate processing, unaffected by scan time

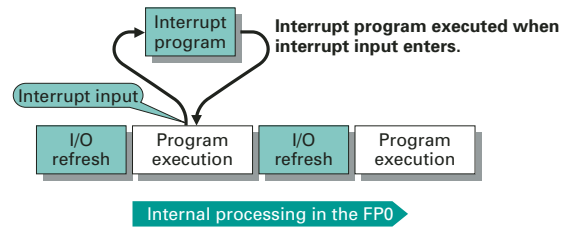

Interrupt input function

Large capacity

A 5k- and 10k-step programme capacity housed within a compact body. Furthermore, data capacity for internal devices like the data register is also ample. The unit's performance can even handle complicated control tasks.

	Control unit type		
	I/O 10-point, 14-point, 16-point type	I/O 32-point type	FPO-T32 CP/T
Programme size	2720 steps	5000 steps	10000 steps
Internal relays	1008 points		
Timers/Counters	144 points		
Data registers	1660 words	6144 words	16383 words

FP0 – Impressive Capabilities

FP0 Functions

Equipped with 2-axis independent positioning and high-speed counter for support of PWM output.

Pulse output function

The unit comes equipped with 2 channels for the output of up to 10kHz pulses (5kHz during 2-channel output). Since these two channels can be separately controlled, the PLC is also suitable for independent 2-axis positioning. Setting automatic trapezoid control, automatic return to home position and JOG operation are made very easy by using instructions specially designed for such operations. (For transistor output type only.)

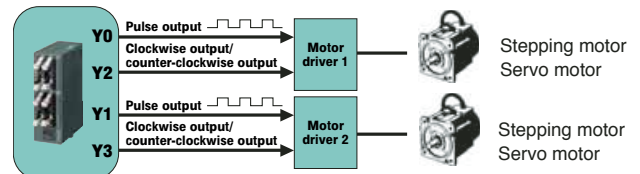

Positioning control is a breeze with the auto trapezoid control command!

High-speed counter function

The high-speed counter is designed to use 4 channels in single-phase operation or 2 channels in 2-phase operation. In single phase operation, the total speed for all 4 channels is 10kHz, in 2-phase operation the 2-channel total is 2kHz total speed, making the unit suitable for conveyer control, inverter control and so forth using an encoder.

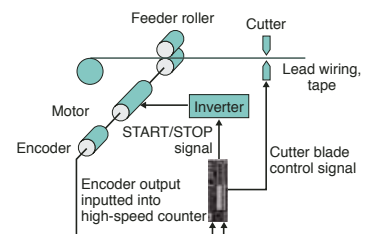

PWM output function

Its PWM (Pulse Width Modulation) output function makes it possible to provide temperature control with a single compact FP0 unit. (For transistor output type only.)

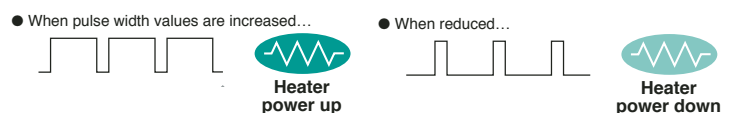

Serial communication function

- The FP0's second RS232C port (types C10CRS, C14CRS, C16C, C32C, and T32C) allows direct connection to computers and operation display panels. Also, bi-directional data communication with barcode readers and other RS232C devices is made easy.
- Both the relay type and transistor output type control units can be optionally equipped with a 2nd RS232C port.

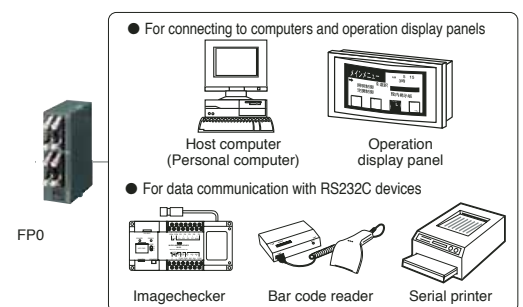

Analogue control function

Analogue control is made simple with four types of analogue modules featuring different numbers of input and output channels. Also, despite its small size, the I/O resolution is a high 1/4000 (12 bits). Support various I/O ranges by setting the DIP switches on the analogue I/O unit for simple operation.

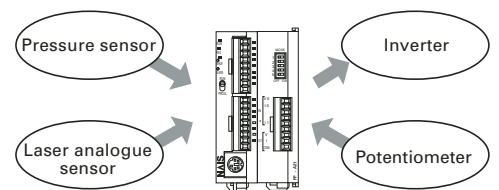

FP0 Communication

Serial Interfaces and Modem Compatible

Communication – Simple and efficient via two serial interfaces: TOOL port and COM port (RS232C interface).

Programming interface TOOL port (also for communication)

In MEWTOCOL-COM Slave mode, this port offers access to the entire FP0 memory area. For example during data exchange between a host PC running SCADA software and an FP0 PLC, the Windows® based FP OPC Server assumes total control of the communications protocol (MEWTOCOL.COM). Therefore the user can disregard the allocation of data ranges and transfer parameters, because there is no additional programming required. The programmer is thus free to concentrate exclusively on the project application requirements.

Communication Interface COM port

(Flexible with two modes of operation, MEWTOCOL-COM Slave (Computer Link) and Program controlled (General purpose)) In addition to the MEWTOCOL-COM Slave (Computer Link) communication possibilities described above, the optional, integrated RS232C COM port in the FP0 CPU modul (types FP0-C10CRS, FP0-C14CRS, FP0-C16C, FP0-C32C and FP0-T32C) offers flexible programme control (General purpose). In this configuration it is possible to realise communication connections with various peripheral devices via RS232, e.g. bar code readers, slave devices, printers, measurement sensors, telecommunication transmitters, etc.

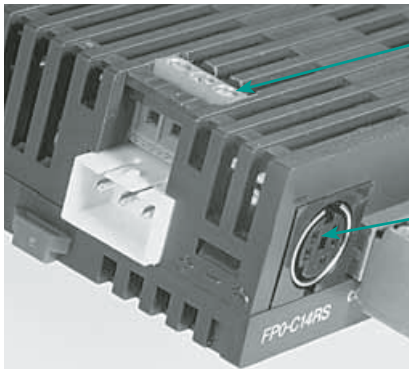

Communication interface COM port

Freely programmable RS232C interface for CPU modules type FP0-C10CRS, FP0-C14CRS, FP0-C16C, FP0-C32C and FP0-T32C

Programming interface TOOL port

For programming or additional master/slave communication using MEWTOCOL COM (Panasonic protocol)

Modem compatible

Even modem communication function is built into this compact body. Using a single telephone line, programming maintenance can be carried out in remote facilities. With C-NET, multiple FP0 units can be connected.

1:1 communication

1:N communication



Multidrop communication

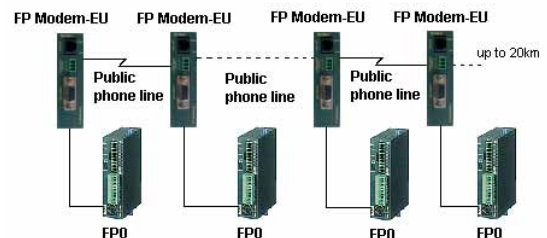

FP0 Communication

Easier Maintenance Than Ever Before

Maintenance saving

Program memory uses EEPROM. In addition, programmes can be changed even in RUN mode!

■ **Overwrite function in RUN mode**

It is possible to overwrite a program while the FP0 is running, such as during program debugging and startup adjustments.

■ **Backup battery unnecessary**

The program memory uses EEPROM. The program and device contents can be stored without a backup battery, and even programming for a machine builder is safe.

■ **Password function**

A password function can be set in order to change a program. Limited to people authorised to make programme changes, protection can be guaranteed better than ever.

■ **Input/output verification LED**

Every unit is equipped with LED I/O indicators housed within a compact body. Input/output status can be verified at a glance.

Simple installation

Comes with either terminal block or MIL connector, simplifying wiring.

Terminal block



The terminal type can be plugged straight in without resorting to crimping (made by Phoenix Contact Co.). Can handle wires from 0.3 to 1.25mm².

Compatible models

FP0-C10RS, C10CRS, C14RS, C14CRS, E8RS, E16RS, E32RS

MIL connector



MIL connectors can be used with 16-point and 32-point units. Due to the loose-wiring, pressure contact type design, wiring is easy without the need for insulation. (MIL-C-83503)

Compatible models

FP0-C16T/C16P/C16CT/C16CP, C32T/C32P/C32CT/C32CP, E16T/E16P, E32T/E32P, FP0T32CP/T32CT

FP0 PROFIBUS DP Slave or Remote I/O Unit

For Cost Effective Control of Distributed Field Device

The FP0 DPS2 can operate either as a DP Slave module or as a remote I/O system to which different decentralised inputs and outputs can be connected. A DIP switch can be used to switch between the two modes:

Mode 1:

DP Slave module. Connect the FP0 or FPΣ (Sigma) CPU + expansion modules to the PROFIBUS network.

Mode 2:

Remote I/O. Connect up to three expansion modules without CPU to the PROFIBUS network.

In remote I/O mode, the unit can be connected to any PLC which offers a PROFIBUS communication interface, making it totally independent of Panasonic PLCs.



FP0-DPS specifications

Item	Description
Type designation	FP0 DP Slave unit, Ord. No. FP0DPS2
PROFIBUS standards complied with	EN 50170, DIN 19245 Part 1 and Part 3
Baud rates	9.6 / 19.2 / 93.75 / 187.5 / 500 / 1,500 / 3,000 / 6,000 / 12,000 Kbaud automatic baud rate detection
Range of addresses that can be set	0..125
PROFIBUS connection	9-pin Sub-D connector
Configuration	DP-Slave: 2 words input / 2 words output, up to 6 words input / 6 words output if no other expansion is connected Remote I/O: Remote I/O, max. 3 FP0 expansion units
FP0 communication	Via FP0 system bus
Power supply	24VDC (21.6VDC ... 26.4VDC)
Max. power consumption	100mA

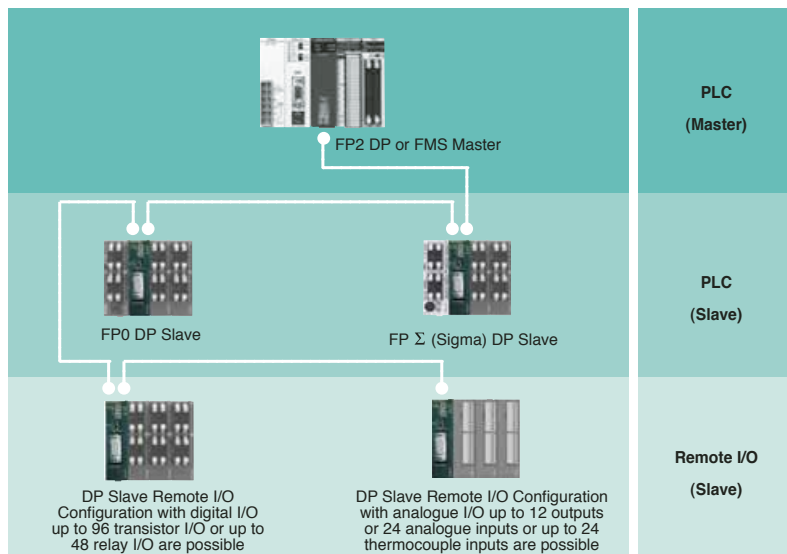

Specially by developed software tools ensure easy configuration and start-up of PROFIBUS products.

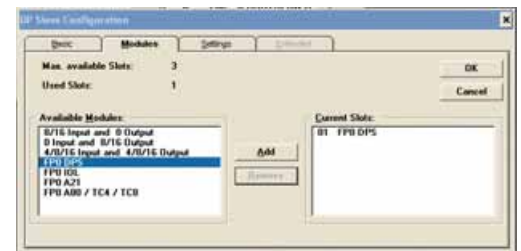

PROFIBUS DP-Configurator AFP86910

FP0 S-LINK Unit

Connects Directly to the S-LINK for Reduced Wiring



FP0-SL1

S-Link is a system which simplifies connection of rapidly increasing control devices accompanying progressing automation and is useful in reducing your costs and construction time.

Features

- 1. Small size of only W30xH90xD60mm.**
Makes use of the T-shaped connectability of the S-LINK for reduced wiring and reduced size of the control panel.
- 2. Controls 64 input points and 64 output points.**
Able to control up to 128 points for S-LINK related devices.
- 3. Allows simultaneous use of expansion units.**
Similar to other FP0 units, up to three expansion units can be used for efficient I/O wiring.
- 4. A wide range of I/O modules allow manifold customer-oriented network layouts.**

Power supply specification

Item	Description
Power supply	24VDC

Performance specifications

Item	Description	
Number of I/O points	S-LINK block: 64 input points, 64 output points (fixed)	
Expansion	Max. 3 units Expansion section: Max. 96 points	
Operation speed	0.9μs/step	
Internal memory	EEPROM	
Memory capacity	5k-steps	
Memory of execution	Internal relay	1008 points
	Timer/Counter	144 points in total
	Data register	6144 words

Applicable functions

Item	Description
Pulse catch/Interrupt input	None
Analogue I/O	Available by adding analogue I/O unit
Volume input	None
High-speed counter	None
Pulse output	None
RS232C port	1 ch is equipped. 3P terminal blocks (made by Phoenix Contact Co.)

Applicable network

Item	Description
Remote I/O	Control unit functions as S-LINK master station. Available as a slave station of MEWNET-F by adding I/O link unit
Inter-PLC link	Not available
Computer link	Link with TOOL port or RS232C port
Modem connection	Available, type with RS232C port can also send data

Other built-in functions

Item	Description
Program block-edit during RUN	Available
Constant scan	Available
Adjustable input time filtering	Not available
Clock/Calendar function	None

Direct connection for reduced wiring

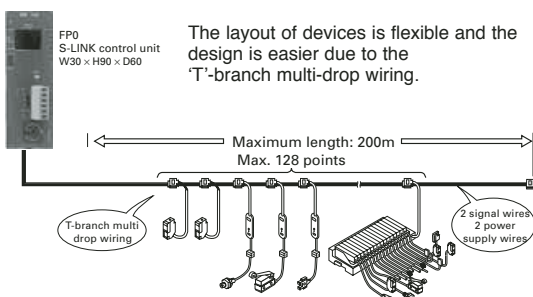

Wire-saving

The use of wires is greatly reduced and the number of connecting terminal blocks is minimised, resulting in large reduction in cost, as well as waste generated during wiring.

Space saving

S-Link devices are compact. The control box can be mounted in a tight space.

Quick construction

Sensors can be easily connected with plug-in connection.

FP0 MEWNET-F Unit

Networking Units

MEWNET-F

The FP0 can be used as a slave station for MEWNET-F (remote I/O system) by adding I/O link unit.

MEWNET-F is a reduced-wiring, remote I/O system that connects PLCs located separately and I/O slave stations with 2-core cabling. By adding an I/O link unit to the FP0, you can link master station PLC and FP0 inputs and outputs via the network.

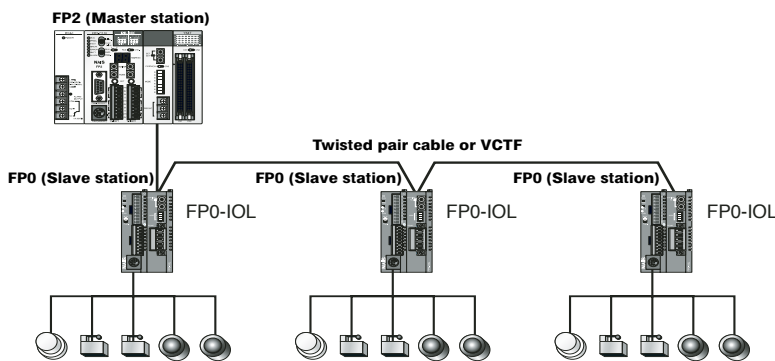

MEWNET-F Slave
FP0-IOL

FP0-IOL Link Unit Specifications

Item	Description
Communication method	Two-wire, half duplex transmission
Synchronous system	Start stop synchronous system
Transmission line	2-wire cable (Twisted-pair cable or equivalent to VCTF 0.75 mm ² x 2C)
Transmission distance (Total distance)	Max. 700m per port (using twisted pair cable) Max. 400m per port (using VCTF cable)
Transmission speed (Baud rate)	0,5Mbit/s
Number of control I/O points per an I/O link unit	64 points (Input: 32 points. Output: 32 points)
Remote I/O map allocation	32X/32Y
Interface	Conforms to RS485
Transmission error check	CRC (Cyclic Redundancy Check) method

C-NET

By using C-NET, you can use multiple FP0s as data collection terminals.

By using the C-NET network and exclusive adapters, you can connect multiple FP0s by multi-drop connection with 2-wire cables. You can use computers for separate control or have network terminals for a centralised management system.

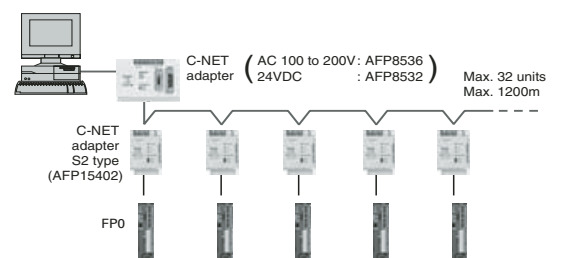

Analogue Signal Processing

FP0 Analogue Units

Features



FP0-A21
2 Inputs/1 Output



FP0-A80
8 Inputs



FP0-A04V
4 Outputs



FP0-A04I
4 Outputs

- Multimode A/D, D/A conversion
Voltage, current and temperature selectable
- 2 analogue inputs (FP0-A21):
-10 to + 10V, 0 to 5V, 0 to 20mA,
8 analogue inputs (FP0-A80):
-10 to + 10V, 0 to 5V, -100 to + 100mV, 0 to 20mA
- 1 analogue output (FP0-A21): -10 to + 10V, 0 to 20mA
4 analogue outputs (FP0-A04V): -10 to + 10V
4 analogue outputs (FP0-A04I): 4 to 20mA
- High resolution: 12-bit
- High conversion speed
FP0-A04V, FP0-A04I: 500 μ s
- PID instruction with auto tuning
- Screw terminal connection

The analogue units can be used with the FP0 and FP Σ (Sigma) so wide range applications are possible from small-scale machines to factory production systems.

Each CPU supports up to 3 FP0 analogue units. Combination with digital and analogue expansion units is freely allowed.

Highest performance is offered with 12-bit resolution. With a current and voltage output conversion time of up to 500 μ s, the units are capable of high-speed processing.

The multimode FP0 analogue unit can be configured via the DIP switches on the front side into the required analogue ranges. Communication with the FP0 CPU unit is achieved via the expansion bus. The expansion bus is automatically connected after the FP0 analogue unit is connected to the FP0 CPU unit.

Note: Function blocks for the FPWIN Pro programming system can be downloaded free of charge from our Web site.

Analogue Signal Processing

FP0 Analogue Units

General specifications

Item	Description
Rated operating voltage	24VDC
Operating voltage range	21.6 to 26.4VDC
Rated current consumption	FP0-A80: 60mA or less, FP0-A21/A04V: 100mA or less, FP0-A04I: 130mA or less
Ambient temperature	0°C to +55°C
Storage temperature	-20°C to +70°C
Size	90 x 25 x 60mm
Weight	Approximately 100g

Analogue input specification

Item	Description	
Product	FP0-A21	FP0-A80
Number of channels	2 channels/unit	8 channels/unit
Input range selectable (2 CH)	Voltage mode	0 to 5V/-10V to +10V
	Current mode	0 to 20mA
	Thermocouple mode	K, J, T type thermocouple K up to 1000°C or -100°C to terminal temperature (selectable) J up to 750°C or -100°C to terminal temperature (selectable) T up to 350°C or -100°C to terminal temperature (selectable)
Digital output	0 to 5V/0 to 20mA: K 0 to K 4000 (H 0000 to H 0FA0) -10 to +10V (-100 to +100mV): K -2000 to K +2000 (HF830 to H07D0) *1 Thermocouple: The value of broken wire detection is K 20000. For plus: K temperature of terminal *2 to K 1000 (Unit is Celsius) For minus: K-100 to K temperature of terminal *3 (Unit is Celsius)	-
Resolution	12 bits (1/4000)	
Conversion speed	Voltage/current mode: 1ms/channel Thermocouple mode: 560ms/channel	2ms/channel
Overall accuracy	Voltage/current mode: 1% for full-scale (0 to 55°C), 0.6% for full-scale (at 25°C) Thermocouple mode: Offset error (0 to 55°C), 2% for full-scale (K-type) 2.7% for full-scale (J-type) 5.8% for full-scale (T-type) Linearity error (0 to 55%): 1% for full scale	-
Input impedance	Voltage mode: 1M ohm or more Current mode: 250ohm	
Maximum input	Voltage mode: +/- 15V Current mode: +30mA	
Insulation	Optical coupler insulation between analogue input terminal and FP0 internal circuit (No insulation between analogue inputs) DC/DC converter insulation between analogue input terminal and analogue I/O unit external power supply DC/DC converter insulation between analogue input terminal and analogue output terminal	
FP0 input address	32 input contact points: First 16 points analogue input CH0 data (WX2) *4 Last 16 points analogue input CH1 data (WX3) *4	32 input contact points: First 16 points analogue input CH0, 2,4,6 data (WX2) *4 Last 16 points analogue input CH1,3,5,7 data (WX3) *4

*1 K means decimal constants.

*2 Reference temperature → Reference points is start points.

*3 Reference temperature → Reference points is end points.

*4 The address varies depending on the position of the analogue unit. (WX2/3, WX4/5 or WX6/7)

Analogue output specification

Item	Description		
Product	FP0-A21	FP0-A04V	FP0-A04I
Number of channels	1	4	4
Output signal selectable	-10V to +10V 0 to 20mA	-10V to +10V	4 to 20mA
Digital input *1	0 to 20mA: K 0 to K 4000 -10V to +10V: K -2000 to K+2000	K -2000 to K+2000	K 0 to K 4000
Resolution	12 bits (1/4000)		
Conversion speed	500ms	500μs	500μs
Overall accuracy	1% for full-scale (0 to 55°C), 0.6% for full-scale (at 25°C)		
Output impedance	Voltage mode: less than 0.50Ω		
Maximum output current	Voltage mode: +/- 10mA		
Allowable output load resistance	Less than 300Ω	1000Ω or more	Less than 500Ω
Insulation	Optical coupler insulation between analogue output terminal and FP0 internal circuit DC/DC converter insulation between analogue output terminal and analogue I/O unit external power supply DC/DC converter insulation between analogue output terminal and analogue input terminal		
Reserved CPU addresses *4	16 output points	32 output points	32 output points

FP0 Thermocouple Input Expansion Units

Enable High Precision Temperature Control at Low Cost

The FP0-TC4 and FP0-TC8 thermocouple units are suitable for user-friendly temperature acquisition using standard thermocouples with high precision.

- Up to three units can be added to each control unit, enabling temperature control of up to 24 channels.
- The temperature data obtained using the thermocouple is converted to the digital value to be read into the FP0 control unit.
- Standard types of thermocouples can be used: K, J, T and R
- 3 temperature measurement ranges are available:
 - 100°C to +500°C (thermocouple types: K and J)
 - 100°C to +400°C (thermocouple type : T)
 - 0°C to +1500°C (thermocouple type : R)
- The temperature data measured using the sensor is converted to degrees Celsius or degrees Fahrenheit inside the thermocouple unit.
- The converted data (°C or °F) is averaged, so that even unstable input signals can be properly read.
- Broken thermocouples can be detected.

Temperature control



FP0-TC8
8 channels

FP0-TC4
4 channels

FP0-TC4 and FP0-TC8 specifications

Item	Specification		
Input points	Up to 8 channels per unit (The number of input points can be changed 2, 4, 6 and 8 channels are available)		
Input range	Thermocouple types K, J	-100°C to 500°C	
	Thermocouple types T	-100°C to 400°C	
	Thermocouple types R	0°C to 1500°C	
Resolution	0.1°C		
Sampling cycle	300ms: when using 2 channels for an input points 500ms: when using 4 channels for an input points 700ms: when using 6 channels for an input points 900ms: when using 8 channels for an input points		
Accuracy	Range for K and J	(-100°C to 500°C):	0.8°C
	Range for T	(-100°C to 400°C):	0.8°C
	Range for R	(0°C to 99.9°C):	3°C
		(100°C to 299.9°C):	2.5°C
		(300°C to 1500°C):	2°C
Input Impedance	More than 1MΩ		
Insulation method	- Between thermocouple input terminals and control unit internal circuits Photo-coupler insulation/DC-DC insulation - Between thermocouple input terminal channels PhotoMOS relay insulation		

FPO RTD Input Expansion Unit

User Friendly Acquisition of Temperatures with High Precision

Features

- The module can be easily installed in an existing system. Special connection cables, backplanes, and so forth are unnecessary as the expansion unit employs a stacking system that uses expansion connectors and lock levers on the surface of the unit itself.
- Multiple RTD types are allowed in one module, creating a cost-effective solution.
- About the **application areas**:
 - Measurement and control equipments
 - Process and machine controls
 - Greenhouse and agricultural industries



FPO-RTD6
6 channels

Take advantage of the various FPWIN Pro libraries with many functions and function blocks. These ready-made programmes can be saved and reused time and again and will help you to shorten the time needed to develop applications drastically, and consequently save valuable human resource costs.

Process and Temperature Control Library: NCL-PTC-LIB*

The numerous functions of this library simplify the programming of closed loop controlled electrical installations. The library includes linear and non-linear controller types such as the P/I/PI/PID controller and two-point / three-point controllers with and without hysteresis. Functions for dead band, interpolation, lamp limiting, dead time and averaging are also included.

* available November 2006

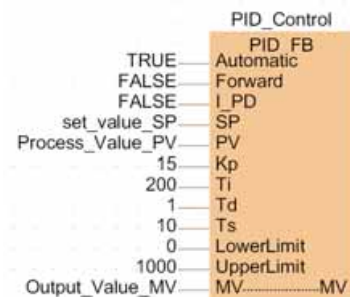

FPO-RTD specifications

Item	Specification	
Input points	Up to 6 channels per unit - 3 inputs per one Phoenix screw terminal - for every sensor 3 screws	
Input type	Pt100 -200°C to 500°C (3 wire)	
	Pt1000 -100°C to 200°C (2 wire)	
	Ni1000 -30°C to 150°C (2 wire)	
	Resistor measurement	
Sampling cycle	0.1s / 1s for 6 channels - depending on the switch setting (slower cycle timer = higher accuracy)	
Temperature resolution	0.1 K	
Accuracy at ambient temperature: 0-55°C	Cycle time 0.1s:	Pt100: 0.5% / 3.5K, Pt 1000: 0.5% / 2.5K, Ni 1000: 2K, Resistor: 2Ω
	Cycle time 1s:	Pt100: 0.35% / 2.5K, Pt 1000: 0.35% / 1.7K, Ni 1000: 1K, Resistor: 1Ω
Accuracy at ambient temperature: 25°C	Cycle time 1s:	Pt100: 0.3K from -10 to +30°C, 0.2% / 1.4K from -200 to +500°C
		Pt1000: 0.3K from -10 to +30°C, 0.2% / 1.0K from -200 to +300°C
Size	W25xH90xB60mm	

FPO Series

Specification Tables

FPO specifications

Type of control unit		C10 series (Relay output type only)	C14 series (Relay output type only)	C16 series (Transistor output type only)	C32 series (Transistor output type only)	S-LINK type	T32 series (Transistor output type only)	
Programming method / Control method		Relay symbol/Cyclic operation						
Number of I/O points	No expansion (control unit only)	Total: 10 (Input: 6, Output: 4)	Total: 14 (Input: 8, Output: 6)	Total: 16 (Input: 8, Output: 8)	Total: 32 (Input: 16, Output: 16)	Total: 128 (Input: 64, Output: 64)	Total: 32 (Input: 16, Output: 16)	
	W/expansion 1 *Same type of control and expansion units	Max. 58	Max. 62	Max. 112	Max. 128	Expansion section: max.96 points	Max. 128	
	W/expansion 2 *Mix type of relay and transistor units	Max. 106	Max. 110	Max. 112	Max. 128		Max. 128	
Program memory		EEPROM (No back-up battery required)						
Program capacity		2.7k steps		5k steps		10k steps		
Kinds of instruction	Basic				83			
	High-level				115			
Operation speed (central value/step)		0.9µs (Basic instruction)						
Memory for execution	Relay			1008 points				
				144 points				
	Memory area	1660 words		6144 words		16384 words		
Master control relay (MCR)				2 words				
Number of labels (JMP and LOOP)				32 points				
Differential points				64 labels		255 labels		
Number of step ladder				° unlimited number of points				
Number of subroutines				128 stages		704 stages		
Number of subroutines				16 subroutines		100 subroutines		
Special functions	High-speed counter	1 phase/4 points (10kHz in total) or 2 phases / 2 points (2kHz in total)*		Not available		Available (same as 32 points series)		
	Pulse output	Not available		2 points (10 kHz* in total), enable to control 2 channels individually*		Not available		
	PWM output	Not available		0.15Hz to 1kHz		Not available		
	Pulse catch input/interrupt input			6 points (with high-speed counter)		Not available		
	Interrupt programme	7 programs (external 6 points, internal 1 point)				1 program (internal 1 point)		
	Periodical interrupt			0.5ms to 30s				
	Constant scan			Available				
RS232C port		One RS232C port is mounted on each of the models FPO- C10CR, C14CR, C16CT, C16CP, C32CT, C32CP, T32CT, T32CP and SL1 type (3P terminal block) Transmission speed (Baud rate): 300 to 19200bits/s , 3m Communication method: half duplex Transmission distance: 3m						
Maintenance	Memory back up	Programme and system register	Stored programme and system register in EEPROM					
		Operation memory	Stored fixed area in EEPROM Counter: 4 points Internal relay: 32 points Data register: 8 words		Stored fixed area in EEPROM Counter: 16 points Internal relay: 128 points Date register: 32 words		Backup is provided by secondary battery. The holding range for the timers, counters, internal relays, and data registers are specified with the programming tool.	
	Self-diagnosis functions	Watchdog timer, program syntax checking, etc.						
	Clock/calender function	Not available					Available	
Other functions		Runtime editing, password setting						

* For the limitations while operating units, see the manual.

General specifications

Item	Description
Rated operating voltage	24VDC
Operating voltage range	21.6 to 26.4VDC
Allowable no voltage time	10 points, 14 points type
	16 points, 32 points, S-LINK type
Ambient temperature	5ms (at 21.6V), 10ms (at 24V)
Storage temperature	10ms (at 21.6V / 24V)
Ambient humidity	0 C to +55 C
Storage humidity	-20 C to +70 C
Breakdown voltage	30 to 85% RH (Non-condensing)
Insulation resistance	30 to 85% RH (Non-condensing)
Vibration resistance	Between input/output terminals and power/ground terminals: 500VAC for 1 minute (for the relay output type, 1500VAC for 1 minute)
Shock resistance	Between input terminals and output terminals: 500VAC for 1 minute (for the relay output type, 1500VAC for 1 minute)
Noise immunity	Between input/output terminals and power/ground terminals: over 100 MΩ (using a 500VDC megger)
Operating condition	Between input terminals and output terminals: over 100MΩ (using a 500VDC megger)
	10 to 55Hz, 1 s sweep/min., double amplitude of 0.75mm, 10min. on 3 axes
	98m/s ² or more, 4 times on 3 axes
	1000 V(p-p) with pulse widths 50ns and 1ms (using a noise simulator)
	Free from corrosive gasses and excessive dust

FPO Series

Specification Tables

Interfaces

Item	Description
Programming TOOL port	RS232, mini DIN socket (5 pin), 9600 or 19200 BAUD, (8 data bits, odd parity, 1 stop bit), Computer link for programming and communication with MEWTOCOL-COM, user configurable modem connection
Communication COM port	RS232 (SD, RD, GND) 3 way screw terminal, 300 to 19200 BAUD, (7 or 8 data bits, none/even/odd parity, 1 or 2 stop bits, start code: none/STX, end code: CR/CR+LF/ETX/none, CCU mode for programming and communication with MEWTOCOL.COM, user configurable modem connection, GENERAL PURPOSE MODE controlled by programme for general purpose RS232 communication

Input specifications

Item	Description
Insulation method	Optical coupler
Rated input voltage	24VDC
Operating voltage range	21.6 to 26.4VDC
Rated input current	4.3mA or less (at 24VDC)
Input points per common	6 points/common (C10RS) 8 points/common (C14RS,C16T/C16P,E16T/E16P) 16 points/common (C32T/C32P,E32T/E32P)
ON voltage/ON current	19.2V or less/ 3mA or less
OFF voltage/OFF current	2.4V or more/ 1mA or more
Input impedance	Approx. 5.6kΩ
Response time	50μs or less (at X0,X1) *
	OFF→ ON 100μs or less (at X2 to X5)
	ON→ OFF 2ms or less (at X6 to XF)
Operating indicator	LED display

*: Since the response time of X0 to X5 is very fast (for high-speed counter input), the FPO happens to catch chattering noise as an input signal. To prevent this, it is recommended that timer instruction should be included in the programme.

Output specifications

1) Relay output type

Item	Description
Output type	Normally open (1 Form A)
Rated control capacity	2A 250VAC, 2A 30VDC (4.5A/common)
Response time	OFF→ ON 10ms or less
	ON→ OFF 8ms or less
Life	Mechanical 20million operations or more
	Electrical 100k operations or more
Surge absorber	None
Operation indicator	LED display

The FPO series conforms to the following standards under the EMC Directive and the Low Voltage Directive.

EMC Directive (89/336/EEC)
EN 50081-2: 1993
EN 50082-2: 1995

Low Voltage Directive (73/23/EEC)
VDE 0160: 1988 (EN 50178: 1995)
(Overvoltage Category II,
non-mains-circuit, pollution degree 2)
EN 61131-2: 1995

2) Transistor output type

Item	Description
Insulation method	Optical coupler
Output type	Open collector
Rated load voltage	24VDC 5 to 24VDC
Load voltage allowable range	4.75 to 26.4VDC
Max. load current	0.1A/points (at DC26.4V) (1A/common) ¹
Max. inrush current	0.3A
Leakage current at OFF time	100μA or less
Max. voltage down at ON time	1.5V or less
External power supply (For internal circuit)	Voltage 21.6 to 26.4VDC
	Current 240mA or less
Response time	OFF→ ON 1ms or less
	ON→ OFF 1ms or less ²
Surge absorber	Zener diode
Operating indicator	LED display

¹: 8 points / common (C16T/C16P,E16T/E16P), 16 points / common (C32T/C32P, T32CP, E32T/E32P)

²: 50μs or less at Y0, Y1 only

Control FFWIN Pro

Programming According to the International Standard IEC 61131-3

FPWIN Pro is the Panasonic programming software developed according to the international standard IEC 61131-3 (for Windows 98, NT V4.0, 2000, ME or XP). This new version is a result of experience gained over many years. We were one of the first PLC manufacturers to offer an IEC 61131-3 programming software, and we are a leading member of the international organisation PLCopen.

Input and output variables are defined once in the global variable list

Functions can be saved in libraries for future reuse

Navigator with tree representation of called functions provides an overview even for very complex projects

The SFC editor (Sequential Function Chart) allows you to easily visualize processes

Additional window for monitoring and forcing variables

Special functions for controlling the SFC program from another program

Multiple address assignment is caught automatically by the compiler

Local variables are allocated automatically by the compiler

Type safe programming using simple or complex data types

Comfortable programming in the graphical LD editor (ladder diagram)

One instruction for different data types (overloaded instructions)

Temporary variables are allocated and released automatically by the compiler

Long variable names make the program self-explanatory

Structuring with selection statements

Using loops for running through incoming data

...or arrays

Using aliases for PLC-independent access to the special data registers, e.g. RTC

The ST editor (Structured Text) solves complex programming tasks

Using STRING functions for analyzing incoming data...

...or for generating formatted output strings

Easy handling of formulas and arithmetic expressions

The most important highlights at a glance:

- One software for all FP Series PLCs.
- 5 programming languages (instruction list, ladder diagram, function block diagram, sequential function chart, structured text) available for all PLCs.
- Programme organisation units, task and project management provide clear structure.
- Reuse of ready-made functions and function blocks saves time for programming and debugging.
- Online monitoring and diagnostics.
- Forcing – Turning off input and output contacts via the PC.
- Modem communication for remote programming, service and diagnostics.
- Extensive comments – online documentation created hand in hand with the programme.
- 6 languages are supported: English, German, French, Italian, Spanish and Japanese.

Free demonstration CD



Part numbers:

- FPWINPROF: Full version supports all FP Series PLCs
- FPWINPROS: Small version, supports FP-e, FP0, FP-X and FPΣ (Sigma)

FP Web-Server

Programme/Operate the FP0 Using a LAN or WAN Network

The multifunctional FP Web-Server provides users with the option of connecting the FP0 or any other FP Series PLC to the Internet/Intranet thus enabling bi-directional communication. No changes to the PLC programs are necessary. Simply assign an IP address to the FP Web-Server and connect the PLC to the FP Web-Server via the serial RS232C interface. A standard browser e.g. MS Internet Explorer or Netscape Navigator can be used for access at the PC.



The FP Web-Server's 3 interfaces

- 10BaseT (RJ45, twisted pair)
 - connects to the Ethernet at 10 Mbit/s
- RS232C (screw terminal)
 - connects to the FPΣ (Sigma) at 1200 to 115.2 kbit/s
- RS232C (SUB-D 9 male)
 - connects to a modem (PPP)

Part number
FPWEBD
FPWEBTOOL2D Configurator Software

Highlights

■ Web-Server:

- PLC data represented as HTML (or XML) pages
- Access via standard Internet browser
- PLC data handling via HTML and Java Applet
- Optional: Password protection, IP-Lok security

■ RS232C device server:

- Ethernet <-> RS232C conversion (MEWTOCOL)
- Transparent RS232C data tunneling via Ethernet
- Programming and visualisation via TCP or UDP

■ Modbus- TCP protocol:

- Communication via standard industrial Ethernet protocol (server and client)

■ Email:

- PLC can send emails
- Email via LAN email server or Internet dial-up
- PLC-defined or pre-stored mail text
- PLC data array as attachment to an email

■ Modem/Ethernet gateway:

- FP Web-Server can be dialed up via modem
- One remote gateway for multiple FP Web-Servers in a local Ethernet network

■ Network time server synchronisation:

- PLC real-time clock update via NTP server

Protocols	TCP/IP, UDP/IP, SMTP, PPP, NTP, FTP, TELNET, HTTP, MEWTOCOL-COM
Number of browsers	Up to 64 browsers can be connected to one FP Web-Server
Number of emails	4 predefined in FP Web Flash memory 1 programmable in PLC DT memory as ASCII
Number of email addresses	4 predefined in FP Web flash memory, 1000 addresses in PLC DT memory, assuming an average of 32 characters are used per email address and that an FP0-T32CP is used, which has 16k word memory
Number of PLC per unit	Two PLCs can be connected 3-pin port (port number: 9094) DB8 port (port number: 9095)
IP address	DHCP or manually set by software
Security	Password and DIP switch
Operating power	24VDC, 75mA (max.)
Dimensions	25 x 90 x 60mm (W x H x D)
LEDs	Power, COM Ethernet connection, COM data exchange
Flash memory	512KBytes
Standards fulfilled	CE, UL, cUL

Control CommX, PCWAY, OPC Server

Visualisation Software for Ready Made or Customised Solutions

Control CommX

The connection in ActiveX technology.

- Connects your Visual Basic application to Panasonic PLCs.
- Gives you the possibility to easily develop highly customised control solutions.
- Create your own application very quickly by simply adding the functionality of ActiveX control to your code written with Visual Basic.
- No knowledge of MEWTOCOL (Panasonic's PLC communication protocol) needed.

FP Data Analyzer

- Convenient acquisition and recording of PLC data from inputs, switches, sensors, outputs, internal and external relays, timers etc.
- Monitoring PLC data graphically in real time
- Analyze signal waveform in real time
- Supports all kind of data types
- Comprehensive trigger functions
- Easy and convenient connection to any Panasonic PLC using the integrated MEWNET Manager

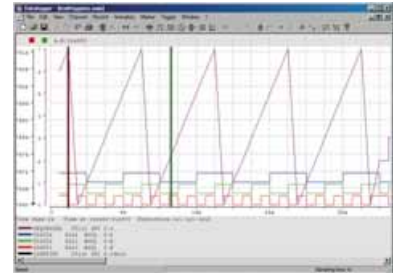

PCWAY

Add-on software for Excel to monitor and change PLC data.

- The Excel add-in software PCWAY is available for data collection of the networked PLCs. The contents of the PLC bits and data registers can be simply shown and managed on Excel worksheets.
- Settings in PCWAY can be used to switch display contents and character colour corresponding to contact on/off status and register values, and perform calculations based on register values. Excel macros are not necessary.

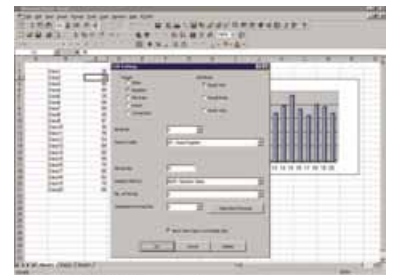

Control FP OPC server¹

The connection between PLC and SCADA software.

- Provides a standard interface between our FP Series PLCs and various SCADA/HMI software used to build a monitoring system compliant with commercially available OPC clients. It is also possible to use OPC automation interface to link our FP series PLCs with Visual Basic.
- OPC (OLE for Process Control) is an interface standard for linking software with various companies' control devices. This standard allows connections between OPC-compliant products.

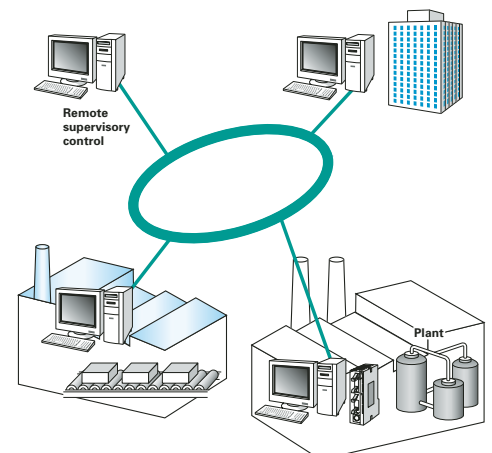

¹: available November 2006

FPO Control and Expansion Units

Products and Order Numbers

Control units

Relay output type



10 points

Input 6 points Output 4 points
Screw terminal type

Order number: **FP0-C10RSA**



10 points

Input 6 points Output 4 points
Screw terminal type

Order number: **FP0-C10CRSA**
with 2nd RS232C interface



14 points

Input 8 points Output 6 points
Screw terminal type

Order number: **FP0-C14RSA**



14 points

Input 8 points Output 6 points
Screw terminal type

Order number: **FP0-C14CRSA**
with 2nd RS232C interface

Transistor output type



16 points

Input 8 points Output 8 points
MIL connector type

Order number: **FP0-C16PA (PNP)**
FP0-C16TA (NPN)



16 points

Input 8 points Output 8 points
MIL connector type

Order number: **FP0-C16CPA (PNP)**
FP0-C16CTA (NPN)
with 2nd RS232C interface



32 points

Input 16 points Output 16 points
MIL connector type

Order number: **FP0-C32PA (PNP)**
FP0-C32TA (NPN)



32 points

Input 16 points Output 16 points
MIL connector type

Order number: **FP0-C32CPA (PNP)**
FP0-T32CPA (PNP, 10K)
FP0-C32CTA (NPN)
FP0-T32CTA (NPN, 10K)
with 2nd RS232C interface

Expansion units

Relay output type



8 points

Input 4 points Output 4 points
Screw terminal type

Order number: **FP0-E8RSA**



16 points

Input 8 points Output 8 points
Screw terminal type

Order number: **FP0-E16RSA**



32 points

Input 16 points Output 16 points
Screw terminal type

Order number: **FP0-E32RSA**



8 points

Input 8 points
MIL connector type

Order number: **FP0-E8XA**



16 points

Input 16 points
MIL connector type

Order number: **FP0-E16XA**

Transistor output type



8 points

Output 8 points
MIL connector type

Order number: **FP0-E8YPA (PNP)**
FP0-E8YTA (NPN)



16 points

Output 16 points
MIL connector type

Order number: **FP0-E16YPA (PNP)**
FP0-E16YTA (NPN)



16 points

Input 8 points Output 8 points
MIL connector type

Order number: **FP0-E16PA (PNP)**
FP0-E16TA (NPN)



32 points

Input 16 points Output 16 points
MIL connector type

Order number: **FP0-E32PA (PNP)**
FP0-E32TA (NPN)

Notes:

- A power cable (order number AFP0581) is enclosed with the control unit and the relay output type expansion units (Transistor output type upgrade units do not require a power cable).
- Two Phoenix terminals (9-pin) are needed with the relay output type terminal type. A 2.5mm width screwdriver is needed for the wiring. Have ready a dedicated terminal screwdriver (order number AFP0806: Phoenix order number SZS0, 4 X 2.5 compatible), or equivalent.
- A loose-wiring pressure socket and contact (2 pins with order numbers FP0-C16T/P, E16T/P, and 4 pins with order numbers FP0-C32T/P, E32T/P) are needed with the transistor output type. A loose-wiring connector pressure contact tool (order number AXY52000) is needed for the wiring.

FP0 Analogue and Networking Units

Products and Order Numbers

Analogue units



3 points

Input 2 points Output 1 points
Screw terminal type

Order number: **FP0-A21A**



8 points

Input 8 points
Screw terminal type

Order number: **FP0-A80A**



4 points

Output 4 points
Screw terminal type

Order number: **FP0-A04V**



4 points

Output 4 points
Screw terminal type

Order number: **FP0-A04I**

Temperature control units



4 points

Input 4 points
Screw terminal type

Order number: **FP0-TC4**



8 points

Input 8 points
Screw terminal type

Order number: **FP0-TC8**



6 points

Input 6 points
Screw terminal type

Order number: **FP0-RTD6**

Networking units



PROFIBUS

PROFIBUS
DP-Slave or Remote I/O

Order number: **FP0-DPS2**



MEWNET-F

MEWNET-F
Slave

Order number: **FP0-IOL**



S-LINK CPU

S-LINK
Master

Order number: **FP0-SL1**

AC power supply



Input Output
85 to 265VAC 24V DC / 0.7A
Screw terminal type

Order number: **FP0-PSA2**



Input Output
85 to 265VAC 24VDC / 2.1A
Screw terminal type

Order number: **FP-PS24-050E**

FP Memory Loader



Read or write programs from
or to a PLC

Order number: **AFP8670**

Accessories

Products and Order Numbers

Options

Wiring tools



Terminal screwdriver

Necessary when wiring relay output type & terminals (Phoenix).

Order number: **AFP0806**

Parts for attachment



Slim attachment plate model

Screw-stop attachment plate. Slim model.

Order number: **AFP0803** (set of 10)



Attachment example



Flat attachment plate model

Screw-stop attachment plate. Flat model.

Order number: **AFP0804** (set of 10)



Attachment example

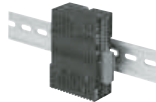

DIN rail attachment example



DIN rail

Standard DIN rail of width 35mm 1.378inch and length 1m.

Order number: **ATA48011**



Stopper fitting

DIN rail stopper fitting.

Order number: **ATA4806**

I/O cables & networks

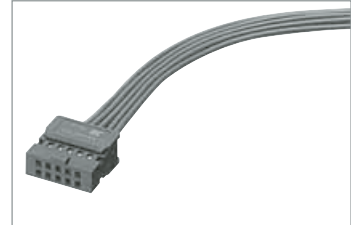

Transistor output type I/O cable

Loose-wiring cable (10 leads) AWG24 with connectors attached at one end, 1 set: 2 cables

<Length 1m > 2 cable set

<Length 3m > 2 cable set

Order number: **AFP0521**

Order number: **AFP0523**

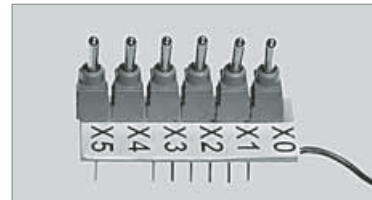

Input simulator

for FP0 relay output type, 6 switches

Order number: **SWITCH-FP0**

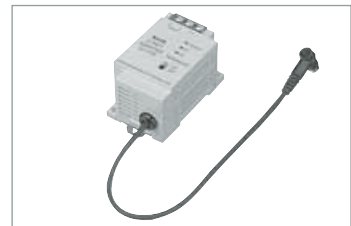

C-NET adapter S2 type

Adapter for linking to a higher-placed computer. With 30cm dedicated cable. Power source unnecessary.

Order number: **AFP15402**

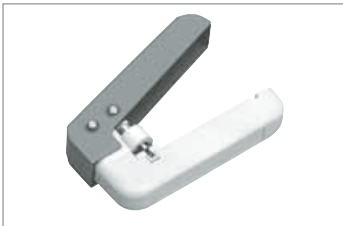

Loose-wiring connector pressure contact tool

Necessary when wiring transistor output type connectors.

Order number: **AXY52000**

Notes:

- (1) One I/O cable set (2 cables) is necessary with the following models: FP0-C10RS, C14RS, E8RS, E16RS.
- (2) One I/O cable set (2 cables) is necessary with the following models: FP0-C16T/C16P, E16T/E16P.
- (3) Two I/O cable sets (total 4 cables) are necessary with the following models: FP0-C32T/C32P, E32T/E32P.

Additional parts

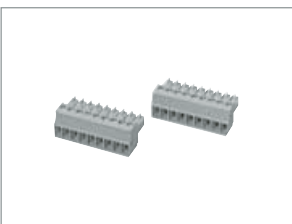

Terminal socket

Attaches to relay output terminal type. Additional part.

Order number: **AFP0802**(2 sockets per pack)

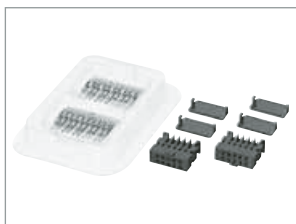

Loose-wiring pressure socket

Transistor output type connectors. Additional part.

Order number: **AFP0807**(2 sockets per pack)

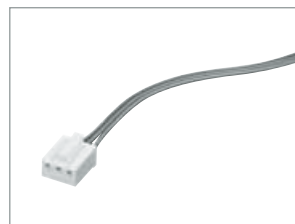

Power cable

Attaches to control units and relay output type expansion units. Length: 1m.

Order number: **AFP0581**(1 cable per pack)

Programming Tools and Current Consumption List

Products and Order Numbers

Programming software and cables



Control FPWIN Pro

English, German, French, Italian, Spanish, Japanese menu selectable. According to IEC 61131-3 Standard

Order number:

- Small version for small PLC only (FP0, FP-e, FPΣ (Sigma))
 - FPWINPROSEN (English manual)
 - FPWINPROSDE (German manual)
 - FPWINPROSFR (French manual)
- Full version for all FP-Series PLCs
 - FPWINPROFEN (English manual)
 - FPWINPROFDE (German manual)
 - FPWINPROFFR (French manual)



Control FPWIN GR

English, Italian, Spanish, menu selectable

Order number:

- Full version for all FP-Series PLCs:
 - FPWINGRF2 (English manual)



Programming cable

PC 9-pin D-Sub to the PLC (mini-DIN 5-pin)
Order number: **AFC8513**

Software Tool	Order number
PCWAY with USB port dongle	AFW10031
PCWAY with Printer port dongle	AFW10011
Control FP OPC Server (1 licence, available Nov.2006)	AFPS03510D
Control FP OPC Server (10 licences, available Nov.2006)	AFPS03516D

Software Tool	Order number
FP Data Analyzer	AFPS04510D
Control Configurator MS, alarm notification system via SMS *	AFPS34610D
Control CommX with USB port dongle	AFW20031
Control CommX with Printer port dongle	AFW20011

* see www.panasonic-electric-works.com or ask your dealer for the CCMS flyer

Current consumption list

Type of unit	Part number	Current Consumption	
		Supply to the power supply connector of the control unit ¹	Supply to the power supply connector of the expansion and intelligent units ²
Control unit	C10 series, C14 series	100mA or less	–
	C16 series	40mA or less	–
	C32 series, T32 series	60mA or less	–
	SL1	150mA or less	–
	E8X	10mA or less	–
Expansion unit	E8YRS	10mA or less	100mA or less
	E8YT, E8YP	15mA or less	–
	E8RS	20mA or less	50mA or less
	E16RS	20mA or less	100mA or less
	E32RS	20mA or less	200mA or less
	E16X	20mA or less	–
	E16T, E16P, E16YT, E16YP	25mA or less	–
	E32T, E32P	40mA or less	–
Intelligent unit	A21, A04V	20mA or less	100mA or less
	A80	20mA or less	60mA or less
	A04I	20mA or less	130mA or less
	IOL	30mA or less	40mA or less
	TC4, TC8, RTD6	25mA	–
PROFIBUS unit	FP0-DPS2	10mA or less	100mA or less
FP programmer	AFP1114V2	50mA or less	–
C-NET adapter	AFP15402	50mA or less	–

Notes:

¹: The current consumption from the power supply connector block of the control unit. Calculate the total current consumption based on the combination of the units.

²: The current consumption from the power supply connector block of the expansion unit and intelligent unit.

FPO Series

Power Supplies

Features

Small size:

- FPO power supply: 90 x 60 x 30.4mm
- FP power supply: 115 x 75 x 42mm

Maximum output current:

- FPO power supply: 0.7A (24VDC)
- FP power supply: 2.1A (24VDC)

Multiple voltage input:

85 to 265VAC

Optimal protection:

overvoltage, overcurrent, overheating, etc.

Global approvals

(UL/cUL, EN, CE-marking)

DIN-rail mounting

(FPO power supply also side mounting)

Performance specifications

Order number:	FPO-PSA2	FP-PS24-050E
Primary side:		
Rated operating voltage	115 / 230VAC	
Operating voltage range	85 to 265VAC	
Rated operating frequency	50 / 60Hz	
Operating frequency range	40 to 70Hz	
Inrush current	< 50A at 55°C	< 50A at 25°C / < 70A at 55°C
Current consumption	145mA (at 230VAC and 0.7A output current)	400mA (at 230VAC and 2.1A output current)
Over voltage protection	PROTECTED	
Secondary side:		
Rated output voltage	24VDC	
Output voltage range	23.5V to 24.5VDC	
Nominal output current	0.7A	2.1A
Output current range	0 to 0.7A	0 to 2.1A
Output ripple	< 60mV _{pp}	< 240mV _{pp}
Short circuit protected	Electronic, automatic restart mode	Continuous
Over voltage protected	Yes	
Over load protected	Yes (switch off at approx. 0.8A and more)	Yes (switch off at approx. 3.5A and more)
Holding time	Min. 20ms at 230VAC	Min. 110ms at 230VAC
Power OK signal	-	Yes

General specifications

Ambient temperature	0°C to +55°C	
Storage temperature	-20°C to +70°C	
Ambient humidity	5 to 85% non-condensing	
Storage humidity	5 to 85% non-condensing	
Vibration resistance	10 to 55Hz, 1 cycle/min.: double amplitude of 0.75mm, 10 min. on 3 axes	
Shock resistance	10g min., 4 times on 3 axes	
Life time min.	7 years at nom. load, 25°C ambient temperature, 20000 h at 55°C with full load/continuous operation	
Mounting	DIN rail or FPO flat attachment plate	DIN rail
Size	90 x 60 x 30.4mm	115 x 75 x 42mm
Input connection AC side	MC connector, 2 pin	2 pin
Output connection DC side	MC connector, 6 pin, 3 pin for „+“ and 3 pin for „-“	5 pin, 2 pin for „+“ and 2 pin for „-“; 1 pin Power OK
Status display	LED (green) at the front side for the secondary voltage indication	

Standards

EMC	EN 50082-2, EN50082-1, EN 50081-2, EN 50081-1	EN 55011/B, EN 55022/B, EN 61000-4-2, -4-3, -4-4, -4-5, -4-6, -4-11
LVD	EN 60950, EN 50178 (overvoltage category 3)	EN 60950, EN 50178 (overvoltage category 2)
Others	UL Recognized according to UL 508, UL 1950, cUL Recognized according to CAN/CSA-C22.2 No. 950.95	
Protection	IP30	IP20 outside/IP67 inside

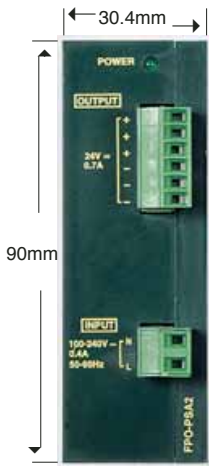

FPO Power Supply
FPO-PSA2

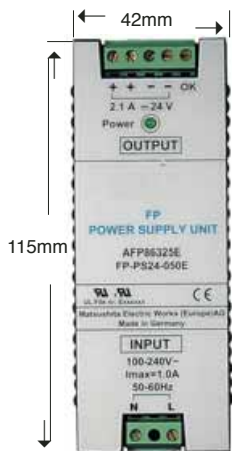

FP Power Supply
FP-PS24-050 E

Notes:

- Mounting distance between the FPO power supply and the FPO CPU is needed to permit heat radiation for the FPO-CPU
- For side mounting, 2 additional blue clips are needed: order part-no. 677-021-17101 (1pce.) for FPO-PSA2
- Mounting distance between the power supply FP-PS24-050E and other devices is needed for cooling/heat radiation.

FP0 Product Overview

Order Numbers

Product Name	Part Number
1. Control Units	
FP0-C10RS, 6 Inputs / 4 Outputs (p+n / Relay)	FP0-C10RSA
FP0-C10CRS, 6 Inputs / 4 Outputs (p+n / Relay), RS232 COM port Interface	FP0-C10CRSA
FP0-C14RS, 8 Inputs / 6 Outputs (p+n / Relay)	FP0-C14RSA
FP0-C14CRS, 8 Inputs / 6 Outputs (p+n / Relay), RS232 COM port Interface	FP0-C14CRSA
FP0-C16P, 8 Inputs / 8 Outputs (p+n / Transistor PNP)	FP0-C16PA
FP0-C16CP, 8 Inputs / 8 Outputs (p+n / Transistor PNP), RS232 COM port Interface	FP0-C16CPA
FP0-C32P, 16 Inputs / 16 Outputs (p+n / Transistor PNP)	FP0-C32PA
FP0-C32CP, 16 Inputs / 16 Outputs (p+n / Transistor PNP), RS232 COM port Interface	FP0-C32CPA
FP0-C16T, 8 Inputs / 8 Outputs (p+n / Transistor NPN)	FP0-C16TA
FP0-C16CT, 8 Inputs / 8 Outputs (p+n / Transistor NPN), RS232 COM port Interface	FP0-C16CTA
FP0-C32T, 16 Inputs / 16 Outputs (p+n / Transistor NPN)	FP0-C32TA
FP0-C32CT, 16 Inputs / 16 Outputs (p+n / Transistor NPN), RS232 COM port Interface	FP0-C32CTA
FP0-T32CP, 16 Inputs / 16 Outputs (p+n / Transistor PNP), RS232 COM port Interface, 10 000 steps Program memory	FP0-T32CPA
FP0-T32CT, 16 Inputs / 16 Outputs (p+n / Transistor NPN), RS232 COM port Interface, 10 000 steps Program memory	FP0-T32CTA
FP0-SL1, S-LINK CPU, Master	FP0-SL1
2. Expansion Units	
FP0-E8RS, 4 Inputs / 4 Outputs (p+n / Relay)	FP0-E8RSA
FP0-E8X, 8 Inputs (p+n)	FP0-E8XA
FP0-E8YP, 8 Outputs (Transistor PNP)	FP0-E8YPA
FP0-E8YT, 8 Outputs (Transistor NPN)	FP0-E8YTA
FP0-E16RS, 8 Inputs / 8 Outputs (p+n / Relay)	FP0-E16RSA
FP0-E16P, 8 Inputs / 8 Outputs (p+n / Transistor PNP)	FP0-E16PA
FP0-E16T, 8 Inputs / 8 Outputs (p+n / Transistor NPN)	FP0-E16TA
FP0-E16X, 16 Inputs (p+n)	FP0-E16XA
FP0-E16YP, 16 Outputs (Transistor PNP)	FP0-E16YPA
FP0-E16YT, 16 Outputs (Transistor NPN)	FP0-E16YTA
FP0-E32RS, 16 Inputs / 16 Outputs (p+n / Relay)	FP0-E32RS
FP0-E32P, 16 Inputs / 16 Outputs (p+n / Transistor PNP)	FP0-E32PA
FP0-E32T, 16 Inputs / 16 Outputs (p+n / Transistor NPN)	FP0-E32TA
FP0-A21, 2 analogue inputs / 1 analogue output	
FP0-A80, 8 analogue inputs	FP0-A80A
FP0-TC4, 4 thermocouple inputs	FP0-TC4
FP0-TC8, 8 thermocouple inputs	FP0-TC8
FP0-RTD6, 6 RTD Inputs, Pt100, Pt1000, Ni1000	FP0-RTD6
3. AC Power Supply	
FP0-AC Power Supply 24VDC / 0.7A	FP0-PSA2
4. Network	
FP Web-Server, Web-Server for Intranet/Internet LAN Ethernet, Email	FPWEBD
FP0-DPS2, PROFIBUS DP Slave or Remote I/O unit	FP0-DPS2
FP0-IOL, MEWNET-F Slave unit, I/O link	FP0-IOL
FP0-SL1, S-LINK CPU, Master	FP0-SL1
C-NET S2 Adapter (Multi drop network slave adapter)	AFP15402
C-NET Adapter (RS232/422 PORS485 Interface adapter), 230VAC	AFP8536
5. Programming Tools	
Control FPWIN Pro programming software FP0/FP-e/FPΣ (Sigma), FP-X, including English manual	FPWINPROS EN
Control FPWIN Pro programming software for all FP-Series PLC (FP0/FP-e, FPΣ (Sigma), FP-X, FP2/2SH) including English manual	FPWINPROF EN
Control FPWIN GR programming software for all FP-Series PLC (FP0/FP-e, FPΣ (Sigma), FP-X, FP2/2SH) including English manual	FPWINGRF
Handheld programmer for FP0 and other FP programmable controllers	AFP1114V2
FP0 programming cable PC <-> TOOL port (SUB-D/MiniDIN5), 3m	AFC8513
FP0 programming cable Handheld programmer <-> TOOL port (SUB-D15/MiniDIN5), 1m	AFC8521
FP0 programming cable Handheld programmer <-> TOOL port (SUB-D15/MiniDIN5), 3m	AFC8523
6. Additional Parts	
Transistor output type I/O cable, Loose-wiring cable (10 leads), 1 set: 2 cables, 1m	AFP0521
Transistor output type I/O cable, Loose-wiring cable (10 leads), 1 set: 2 cables, 3m	AFP0523
Power cable, 1m, 1 cable per pack	AFP0581
Slim attachment plate model (set of 10)	AFP0803
Flat attachment plate model (set of 10)	AFP0804
Terminal socket (2 sockets per pack)	AFP0802
Loose-wiring pressure socket (2 sockets per pack)	AFP0807
Loose-wiring connector pressure contact tool	AXY52000
Input simulator for FP0 relay output type, 6 switches	SWITCH-FP0

North America

Europe

Asia Pacific

China

Japan

Panasonic Electric Works

Please contact our Global Sales Companies in:

Europe

▶ Headquarters	Panasonic Electric Works Europe AG	Rudolf-Diesel-Ring 2, 83607 Holzkirchen, Tel. (08024) 648-0, Fax (08024) 648-111, www.panasonic-electric-works.com
▶ Austria	Panasonic Electric Works Austria GmbH PEW Electronic Materials Europe GmbH	Josef Madersperger Str. 2, 2362 Biedermansdorf, Tel. (0 22 36) 2 68 46, Fax (0 22 36) 4 61 33, www.panasonic-electric-works.at Ennsshafenstraße 9, 4470 Enns, Tel. (0 72 23) 8 83, Fax (0 72 23) 8 83 33, www.panasonic-electronic-materials.com
▶ Benelux	Panasonic Electric Works Sales Western Europe B.V.	De Rijn 4, (Postbus 211), 5684 PJ Best, (5680 AE Best), Netherlands, Tel. (0499) 372727, Fax (0499) 372185, www.panasonic-electric-works.nl
▶ Czech Republic	Panasonic Electric Works Czech s.r.o.	Průmyslová 1, 34815 Planá, Tel. 374 799 990, Fax 374 799 999, www.panasonic-electric-works.cz
▶ France	Panasonic Electric Works Sales Western Europe B.V.	French Branch Office, B.P. 44, 91371 Verrières le Buisson CEDEX, Tél. 01 60135757, Fax 01 60135758, www.panasonic-electric-works.fr
▶ Germany	Panasonic Electric Works Deutschland GmbH	Rudolf-Diesel-Ring 2, 83607 Holzkirchen, Tel. (08024) 648-0, Fax (08024) 648-555, www.panasonic-electric-works.de
▶ Ireland	Panasonic Electric Works UK Ltd.	Dublin, Tel. (01) 4600969, Fax (01) 4601131, www.panasonic-electric-works.co.uk
▶ Italy	Panasonic Electric Works Italia s.r.l. PEW Building Materials Europe s.r.l.	Via del Commercio 3-5 (Z.I. Ferlina), 37012 Bussolengo (VR), Tel. (045) 6752711, Fax (045) 6700444, www.panasonic-electric-works.it Piazza della Repubblica 24, 20154 Milano (MI), Tel. (02) 29005391, Fax (02) 29003466, www.panasonic-building-materials.com
▶ Nordic Countries	Panasonic Electric Works Nordic AB PEW Fire & Security Technology Europe AB	Sjöångsvägen 10, 19272 Sollentuna, Sweden, Tel. (08) 59476680, Fax (08) 59476690, www.panasonic-electric-works.se Citadellsvägen 23, 21118 Malmö, Tel. (040) 6977000, Fax (040) 6977099, www.panasonic-fire-security.com
▶ Portugal	Panasonic Electric Works España S.A.	Portuguese Branch Office, Avda Adelino Amaro da Costa 728 R/C J, 2750-277 Cascais, Tel. (21) 4812520, Fax (21) 4812529
▶ Spain	Panasonic Electric Works España S.A.	Barajas Park, San Severo 20, 28042 Madrid, Tel. (91) 3293875, Fax (91) 3292976, www.panasonic-electric-works.es
▶ Switzerland	Panasonic Electric Works Schweiz AG	Grundstrasse 8, 6343 Rotkreuz, Tel. (041) 7997050, Fax (041) 7997055, www.panasonic-electric-works.ch
▶ United Kingdom	Panasonic Electric Works UK Ltd.	Sunrise Parkway, Linford Wood, Milton Keynes, MK14 6LF, Tel. (01908) 231555, Fax (01908) 231599, www.panasonic-electric-works.co.uk

North & South America

▶ USA	PEW Corporation of America	629 Central Avenue, New Providence, N.J. 07974, Tel. 1-908-464-3550, Fax 1-908-464-8513, www.pewa.panasonic.com
--------------	-----------------------------------	---

Asia Pacific / China / Japan

▶ China	Panasonic Electric Works (China) Co., Ltd.	Level 2, Tower W3, The Towers Oriental Plaza, No. 2, East Chang An Ave., Dong Cheng District, Beijing 100738, Tel. (010) 8518-5988, Fax (010) 8518-1297
▶ Hong Kong	Panasonic Electric Works (Hong Kong) Co., Ltd.	RM1205-9, 12/F, Tower 2, The Gateway, 25 Canton Road, Tsimshatsui, Kowloon, Hong Kong, Tel. (0852) 2956-3118, Fax (0852) 2956-0398
▶ Japan	Matsushita Electric Works, Ltd.	1048 Kadoma, Kadoma-shi, Osaka 571-8686, Japan, Tel. (06) 6908-1050, Fax (06) 6908-5781, www.mew.co.jp/e-acg/
▶ Singapore	Panasonic Electric Works Asia Pacific Pte. Ltd.	101 Thomson Road, #25-03/05, United Square, Singapore 307591, Tel. (06255) 5473, Fax (06253) 5689