

DC AXIAL FAN 70x70x10mm



Housing/Blade: Thermoplastic PBT, UL 94V-0
 Insulation Resistance: 10MΩ, 500VDC/min between bare wire and frame
 Dielectric Strength: 5mA max. 500VAC/min between bare wire and frame
 Operation Temperature: -20°C~70°C(Humidity 15%-90%RH)
 Storage Temperature: -40°C~85°C(Humidity 15%-90%RH)
 Lead Wire: UL Type #26 AWG
 Weight: 37 g



ES

IP

SF



DC Axial Fans

Model Number		Voltage (VDC)	Op. Voltage (VDC)	AirFlow (CFM)	Static Pres. (mm-H ₂ O)	Noise (dBA)	Speed (RPM)	Current (mA)	Power (W)	Available Bearing	Additional Function (See Page 3)	Curves
FD7010B05W3-84	★	5	4.5~5.5	23.00	2.30	29.60	3,200	180	0.90	B,F	P,M	①
FD7010B05W5-84	★	5	4.5~5.5	28.40	3.40	35.50	3,900	300	1.50	B,F	P,M	②
FD7010B12W3-84	★	12	6.0~13.8	23.00	2.30	29.60	3,200	120	1.44	B,F	P,M	①
FD7010B12W5-84	★	12	6.0~13.8	28.40	3.40	35.50	3,900	160	1.92	B,F	P,M	②
FD7010B12W7-84	★	12	6.0~13.8	31.60	4.20	38.90	4,400	220	2.64	B,F	P,M	③

- For "Fluid Lubricant " bearing version, change the "B" in the model number to "F".
- If model depicts "★", auto restart protection function built in.

Specifications are subject to change without notice

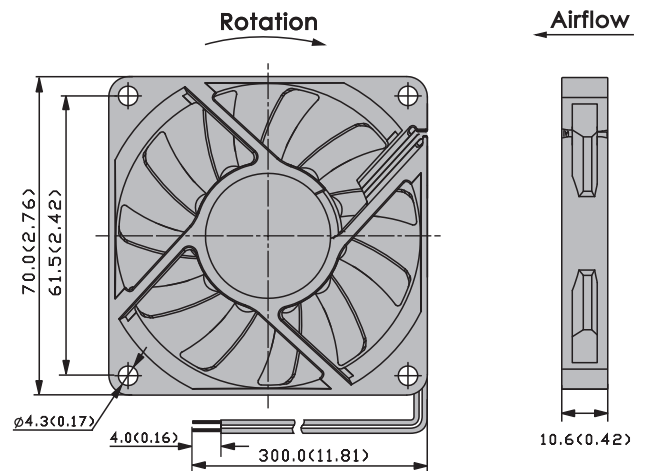
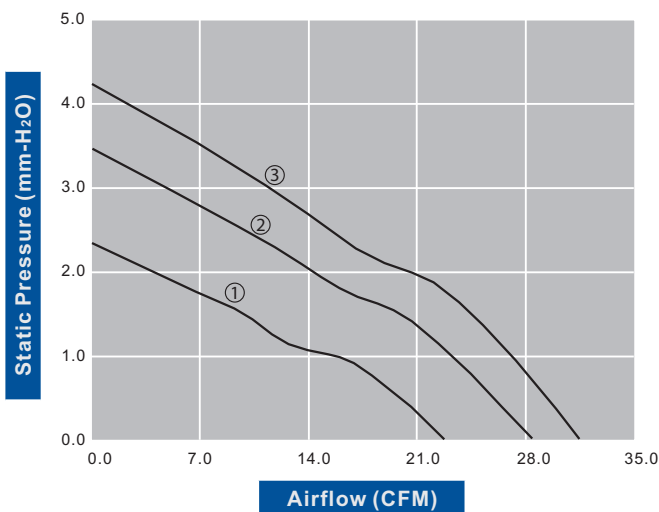

unit: mm(inch)