

AC AXIAL FAN 80x80x38mm



Housing: Die-Cast Aluminum, Painted Black
 Blade: Thermoplastic PBT, UL 94V-0
 Insulation Resistance: 100M Ω , 500VDC/min between bare wire and frame
 Dielectric Strength: 1500VAC for one minute
 Operation Temperature: -10°C~70°C(Humidity 35%-85%RH)
 Storage Temperature: -40°C~85°C(Humidity 35%-85%RH)
 Motor Protection: Impedance Protected
 Weight: 290 g



SS IP

Model Number	Voltage (VAC)	Frequency (Hz)	AirFlow (CFM)	Stat.Pres. (mm-H ₂ O)	Noise (dBA)	Speed (RPM)	Current (mA)	Power (W)	Available Bearing	Curves
FA8038B11T5-96	115	50/60	26.4/29.4	3.9/4.4	29.6/34.5	2,300/2,600	110/90	9/7	B,S	①/②
FA8038B11T7-96	115	50/60	29.4/32.5	4.1/4.9	31.5/36.4	2,400/2,700	140/110	12/9	B,S	③/④
FA8038B22T5-96	230	50/60	26.4/29.4	3.9/4.4	29.6/34.5	2,200/2,600	65/50	11/8	B,S	①/②
FA8038B22T7-96	230	50/60	29.4/32.5	4.1/4.9	31.5/36.4	2,300/2,700	75/60	13/9	B,S	③/④

- For "Sleeve" bearing version, change the "B" in the model number to "S".
- For "Wire Lead" version, change the "T" in the model number to "W".

Specifications are subject to change without notice

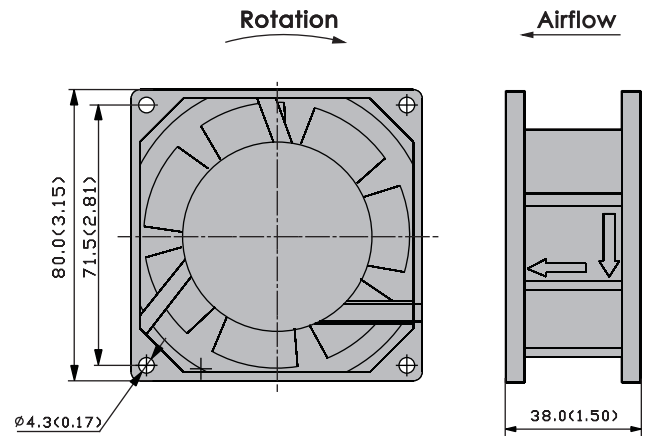
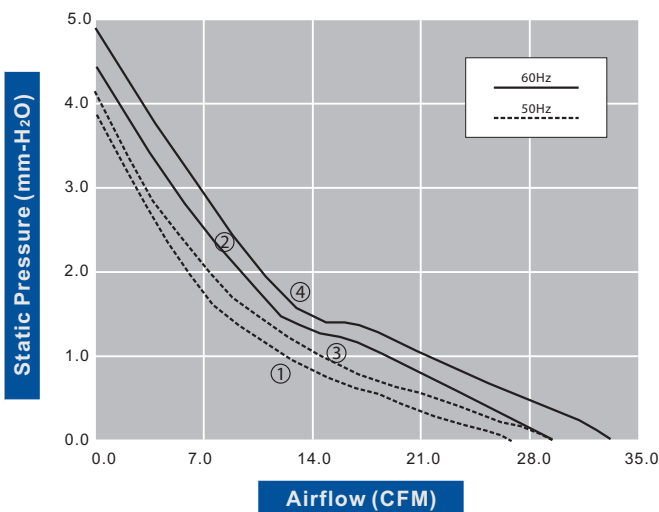

unit: mm(inch)

