

# AC AXIAL FAN 80x80x38mm



Housing: Die-Cast Aluminum, Painted Black  
 Blade: Thermoplastic PBT, UL 94V-0  
 Insulation Resistance: 100M $\Omega$ , 500VDC/min between bare wire and frame  
 Dielectric Strength: 1500VAC for one minute  
 Operation Temperature: -10°C~70°C(Humidity 35%-85%RH)  
 Storage Temperature: -40°C~85°C(Humidity 35%-85%RH)  
 Motor Protection: Impedance Protected  
 Weight: 293 g



SS

Model Number	Voltage (VAC)	Frequency (Hz)	AirFlow (CFM)	Stat.Pres. (mm-H <sub>2</sub> O)	Noise (dBA)	Speed (RPM)	Current (mA)	Power (W)	Available Bearing	Curves
FA8038B11T5-91	115	50/60	25.4/32.5	2.8/4.4	30.5/34.5	2,300/2,800	150/110	16/10	B,S	①/②
FA8038B22T5-91	230	50/60	25.4/32.5	2.8/4.4	30.5/34.5	2,300/2,800	80/60	13/9	B,S	①/②

- For "Sleeve" bearing version, change the "B" in the model number to "S".
- For "Wire Lead" version, change the "T" in the model number to "W".

Specifications are subject to change without notice

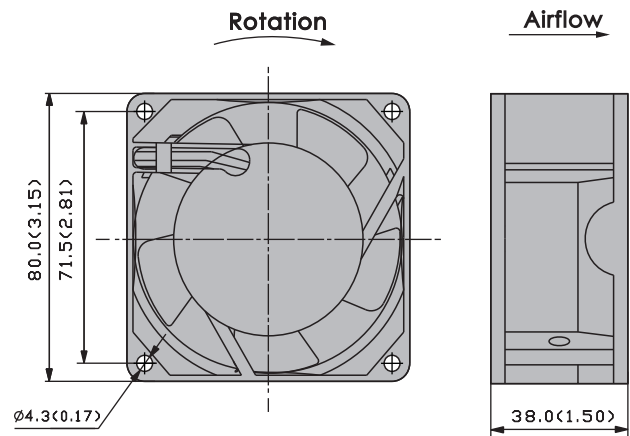
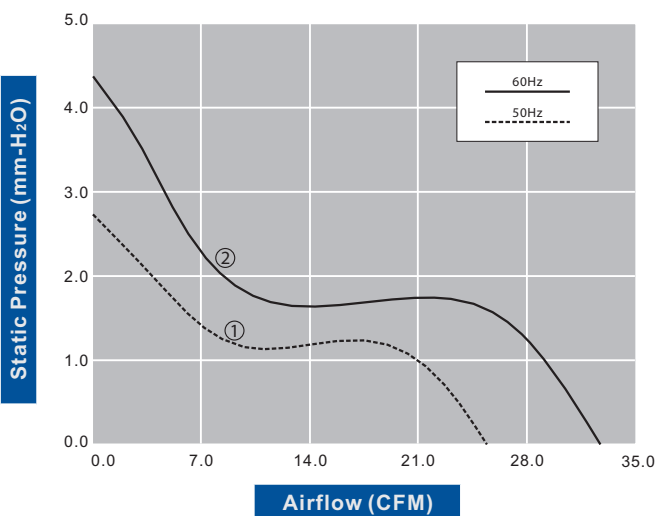

unit: mm(inch)

