

AC AXIAL FAN 172x150x38mm



Housing: Die-Cast Aluminum, Painted Black
 Blade: Thermoplastic PBT, UL 94V-0
 Insulation Resistance: 100MΩ, 500VDC/min between bare wire and frame
 Dielectric Strength: 1500VAC for one minute
 Operation Temperature: -10°C~70°C(Humidity 35%-85%RH)
 Storage Temperature: -40°C~85°C(Humidity 35%-85%RH)
 Motor Protection: Impedance Protected
 Weight: 920 g



SS IP

Model Number	Voltage (VAC)	Frequency (Hz)	AirFlow (CFM)	Stat.Pres. (mm-H ₂ O)	Noise (dBA)	Speed (RPM)	Current (mA)	Power (W)	Available Bearing	Curves
FA1738B11T5-96	115	50/60	198.9/162.4	12.6/11.1	52.2/48.3	2,500/2,350	350/330	28/27	B,S	①/②
FA1738B22T5-96	230	50/60	198.9/162.4	12.6/11.1	52.2/48.3	2,500/2,350	190/180	30/28	B,S	①/②

- For "Sleeve" bearing version, change the "B" in the model number to "S".
- For "Wire Lead" version, change the "T" in the model number to "W".

Specifications are subject to change without notice

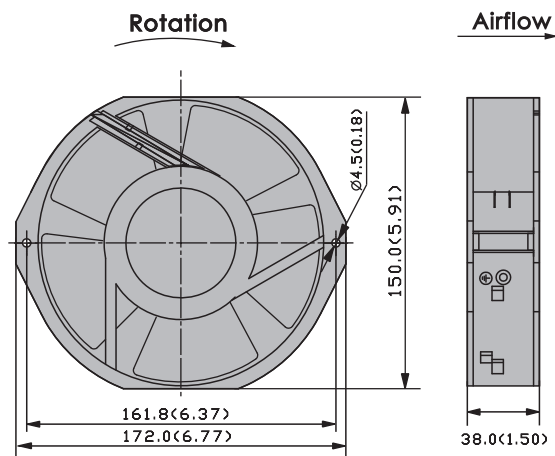
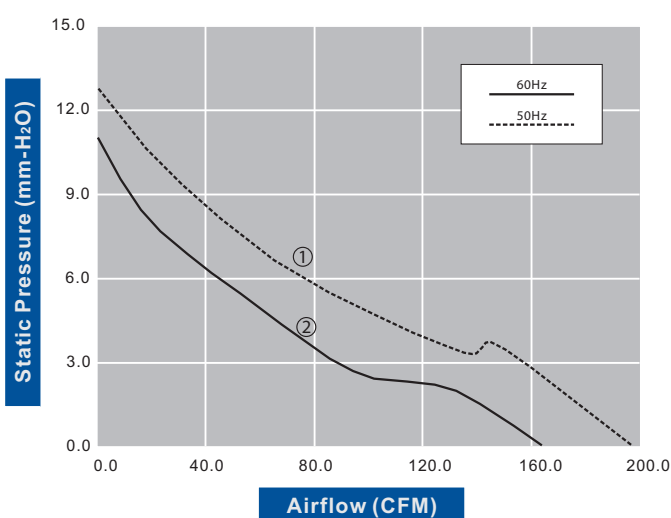

unit: mm(inch)

