

AC AXIAL FAN 170x150x38mm



Housing: Die-Cast Aluminum, Painted Black
 Blade: Thermoplastic PBT, UL 94V-0
 Insulation Resistance: 100M Ω , 500VDC/min between bare wire and frame
 Dielectric Strength: 1500VAC for one minute
 Operation Temperature: -10°C~70°C(Humidity 35%-85%RH)
 Storage Temperature: -40°C~85°C(Humidity 35%-85%RH)
 Motor Protection: Thermal Protected
 Weight: 760 g



SS

Model Number	Voltage (VAC)	Frequency (Hz)	AirFlow (CFM)	Stat.Pres. (mm-H ₂ O)	Noise (dBA)	Speed (RPM)	Current (mA)	Power (W)	Available Bearing	Curves
FA1738B11T7C-31	115	50/60	168.5/201.0	17.0/19.8	56.1/60.1	2,850/3,300	250/260	30/31	B	①/②
FA1738B22T7C-31	230	50/60	168.5/201.0	17.0/19.8	56.1/60.1	2,850/3,300	160/170	36/35	B	①/②

• For "Wire Lead" version, change the "T" in the model number to "W".

Specifications are subject to change without notice

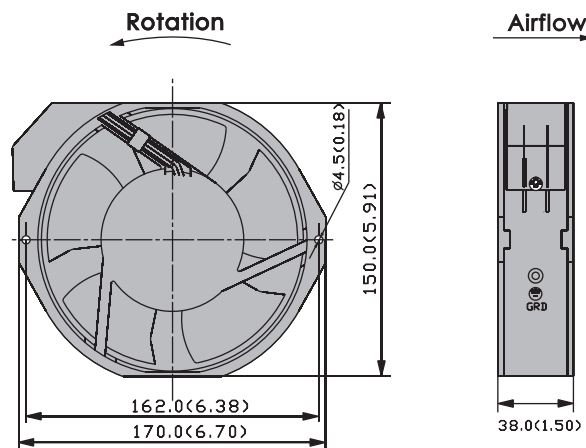
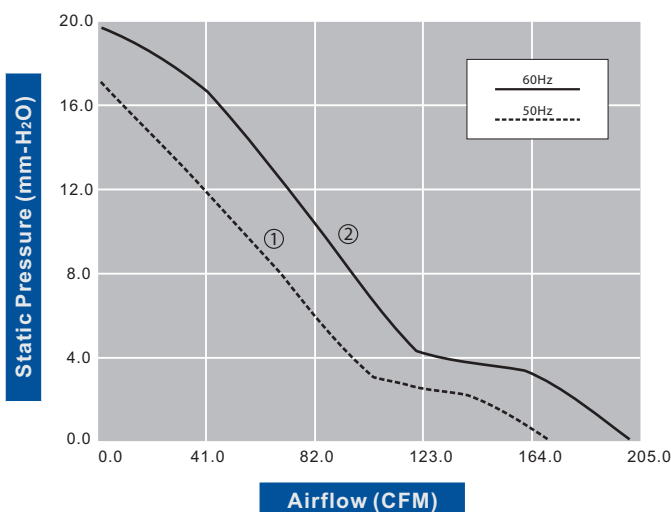

unit: mm(inch)