

## Multilayer Varistor for ESD pulse [DC voltage lines/High speed signal lines]

Series: **EZJZ, EZJP**

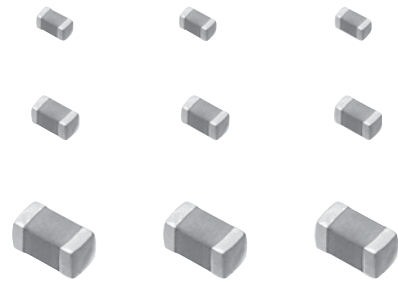

### Features

- Excellent ESD suppression due to original advanced material technology
- Having large electrostatic resistance meeting IEC61000-4-2, Level 4 standard
- Having no polarity (bipolar) facilitated replacing Zener Diodes. Capable of replacing 2 Zener Diodes and 1 Capacitor.
- Lead-free plating terminal electrodes enabling great solderability
- Wide range of products is available by adopting multilayer structure, meeting various needs.
- Low capacitance versions for DC voltage lines of high speed busses
- Ultra low capacitance for high speed signal line
- Applicable to high-speed signal lines, such as interfaces (e.g. USB 2.0, IEEE1394, HDMI, and so on), due to our original ultra-low capacitance technology.
- RoHS compliant

### As for Packaging Methods, Handling Precautions

Please see Data Files

### Explanation of Part Numbers

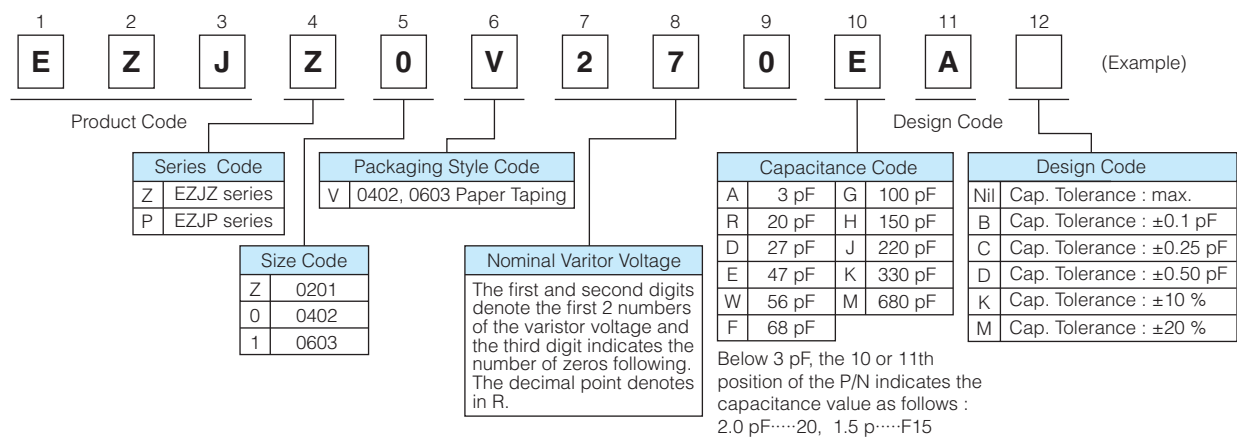

### Construction

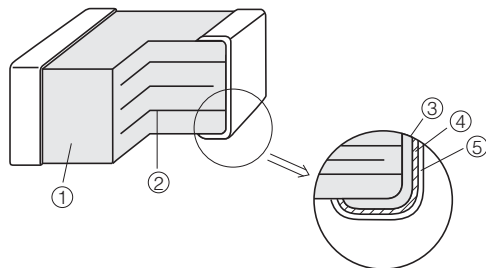

| No. | Name                    |
|-----|-------------------------|
| ①   | Semiconductive Ceramics |
| ②   | Internal electrode      |
| ③   | Substrate electrode     |
| ④   | Terminal electrode      |
| ⑤   | External electrode      |

### Dimensions in mm (not to scale)

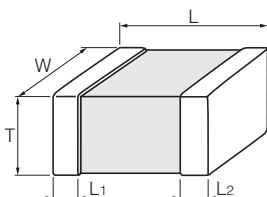

| Size Code | Size(inch) | L         | W         | T         | L <sub>1</sub> , L <sub>2</sub> |
|-----------|------------|-----------|-----------|-----------|---------------------------------|
| Z         | 0201       | 0.60±0.03 | 0.30±0.03 | 0.30±0.03 | 0.15±0.05                       |
| 0         | 0402       | 1.00±0.05 | 0.50±0.05 | 0.50±0.05 | 0.2±0.1                         |
| 1         | 0603       | 1.6±0.1   | 0.8±0.1   | 0.8±0.1   | 0.3±0.2                         |

## Multilayer Varistor, Low Capacitance Type [High speed signal lines]

### Features

- Multilayer monolithic ceramic construction for high speed signal lines
- Ideal for USB 2.0, IEEE1394, and HDMI high speed data busses
- Applicable to high-speed signal lines, such as interfaces (e.g. USB 2.0, IEEE1394, HDMI, and so on), due to our original material technology and multilayer technology.
- Capacitance: 0.8 to 2.1 pF typ.

### Recommended Applications

|              |                               |
|--------------|-------------------------------|
| Mobile phone | Antenna circuit, External IF  |
| DSC, DVC     | USB2.0, IEEE1394              |
| PC, PDA      | USB2.0, IEEE1394, LAN1000BASE |
| TV, DVD      | USB2.0, IEEE1394, HDMI        |
| Game console | Controller, External IF       |

### Ratings and Characteristics

| Size | Part No.     | Maximum allowable voltage DC (V) | Nominal varistor voltage at 1mA (V) | Capacitance (pF) at 1MHz | Maximum ESD IEC61000-4-2 |
|------|--------------|----------------------------------|-------------------------------------|--------------------------|--------------------------|
| 0402 | EZJZ0V80010  | 10                               | 80                                  | 1 max. [0.8 typ.]        | Contact discharge : 8kV  |
|      | EZJZ0V80015D | 5                                | 80                                  | 1.5±0.5                  |                          |
|      | EZJZ0V500AA  | 5                                | 50                                  | 3 max. [2.1 typ.]        |                          |
|      | EZJZ0V800AA  | 18                               | 80                                  | 3 max. [2.1 typ.]        |                          |
|      | EZJZ0V171AA  | 18                               | 170                                 | 3 max. [2.1 typ.]        |                          |
| 0603 | EZJZ1V80010  | 10                               | 80                                  | 1 max. [0.8 typ.]        |                          |
|      | EZJZ1V500AA  | 5                                | 50                                  | 3 max. [2.1 typ.]        |                          |
|      | EZJZ1V800AA  | 18                               | 80                                  | 3 max. [2.1 typ.]        |                          |
|      | EZJZ1V171AA  | 18                               | 170                                 | 3 max. [2.1 typ.]        |                          |

- Operating Temperature Range: -40 to 85 °C
- \* Recommend soldering method : Reflow soldering

### Voltage vs. Current

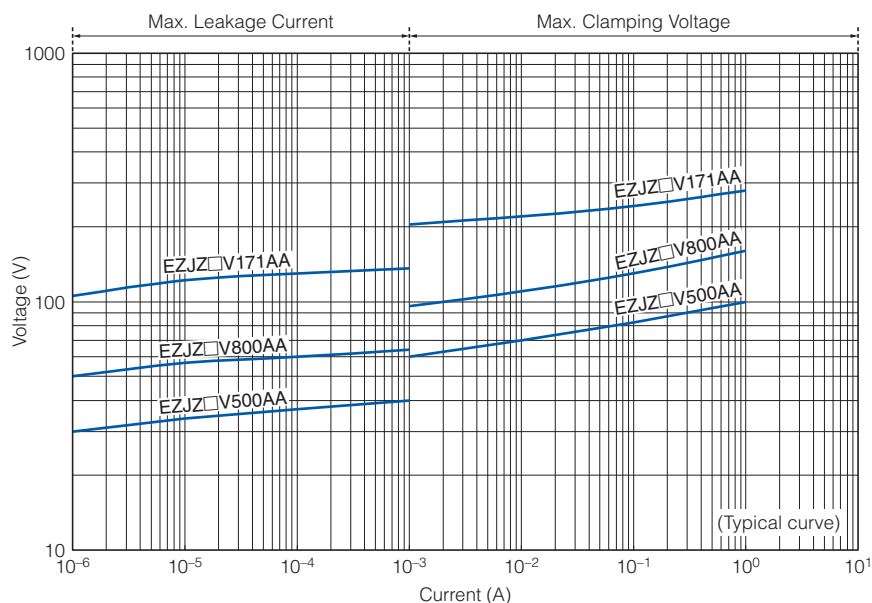

## Capacitance vs. Frequency

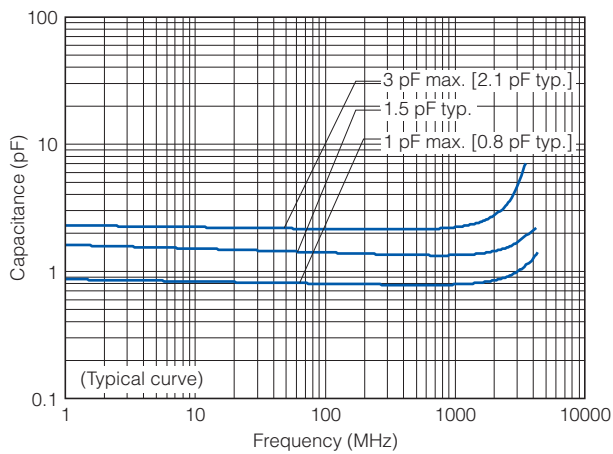

## Impedance vs. Frequency

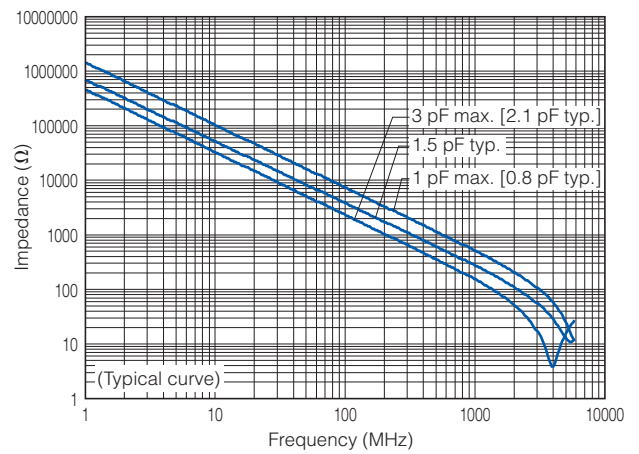

## Attenuation vs. Frequency

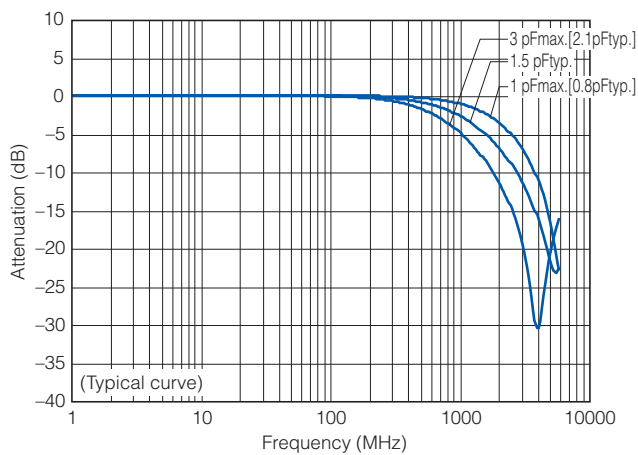

## Multilayer Varistor, Low Voltage Type (Standard Type) [DC voltage lines/Low speed signal lines]

### Features

Wide variety of products is available by adopting multilayer construction, which achieved wide range of usage, such as application to DC voltage lines and signal lines.

- Circuit voltage

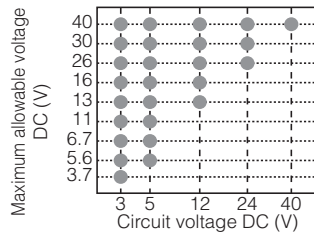

- Varistor voltage : 6.8 to 65 V [at 1 mA]
- Capacitance : 8.5 to 420 pF typ. [at 1 MHz]

### Recommended Applications

|              |  |
|--------------|--|
| Mobile phone | SW, LCD, LED, Audio terminal, Battery pack, Memory card, External IF |
| DSC, DVC     | SW, LCD, LED, USB  |
| PC, PDA      | SW, LCD, LED, USB  |
| TV, DVD      | Audio, Video terminal  |
| Audio        | Audio terminal, Microphone, Receiver                                 |
| Game console | Controller, External IF  |

### Ratings and Characteristics

| Size        | Part No.    | Maximum allowable voltage DC (V) | Nominal varistor voltage at 1mA (V) | Capacitance (pF)    |                    | Maximum peak current at 8/20μs, 2times (A) | Maximum ESD IEC61000-4-2  |
|-------------|-------------|----------------------------------|-------------------------------------|---------------------|--------------------|--|---------------------------|
|             |             |                                  |                                     | at 1MHz             | at 1kHz            |  |                           |
| 0201        | EZJPZV6R8JA | 3.7                              | 6.8                                 | 220 max. [180 typ.] | 175 typ.           | 5  | Contact discharge<br>8 kV |
|             | EZJPZV6R8GA | 3.7                              | 6.8                                 | 100 max. [ 85 typ.] | 100 typ.           | 5  |                           |
|             | EZJPZV080GA | 5.6                              | 8                                   | 100 max. [ 85 typ.] | 100 typ.           | 5  |                           |
|             | EZJPZV120GA | 7.5                              | 12                                  | 100 max. [ 85 typ.] | 100 typ.           | 5  |                           |
|             | EZJPZV120DA | 7.5                              | 12                                  | 27 max. [ 22 typ.]  | 33 typ.            | 1  |                           |
|             | EZJPZV120RA | 7.5                              | 12                                  | 20 max. [ 15 typ.]  | 18 typ.            | 1  |                           |
|             | EZJPZV150RA | 9                                | 15                                  | 20 max. [ 15 typ.]  | 18 typ.            | 1  |                           |
|             | EZJPZV270RA | 16                               | 27                                  | 20 max. [ 15 typ.]  | 16.5 typ.          | 1  |                           |
| 0402        | EZJPZV270BA | 16                               | 27                                  | 10 max. [8.5 typ.]  | 10 typ.            | 1  |                           |
|             | EZJP0V6R8MA | 3.7                              | 6.8                                 | 680 max. [420 typ.] | 650 typ.           | 20   |                           |
|             | EZJP0V6R8GA | 3.7                              | 6.8                                 | 100 max. [ 85 typ.] | 100 typ.           | 3  |                           |
|             | EZJP0V080MA | 5.6                              | 8                                   | 680 max. [420 typ.] | 650 typ.           | 20   |                           |
|             | EZJP0V080KA | 5.6                              | 8                                   | 330 max. [290 typ.] | 480 typ.           | 15   |                           |
|             | EZJP0V080GA | 5.6                              | 8                                   | 100 max. [ 65 typ.] | 100 typ.           | 3  |                           |
|             | EZJP0V080DA | 5.6                              | 8                                   | 27 max. [ 22 typ.]  | 33 typ.            | 1  |                           |
|             | EZJZ0V120JA | 6.7                              | 12                                  | 220 max. [150 typ.] | 175 typ.           | 10   |                           |
|             | EZJZ0V180HA | 11                               | 18                                  | 150 max. [120 typ.] | 140 typ.           | 10   |                           |
|             | EZJZ0V220HA | 13                               | 22                                  | 150 max. [100 typ.] | 116 typ.           | 10   |                           |
|             | EZJP0V270EA | 16                               | 27                                  | 47 max. [ 33 typ.]  | 37 typ.            | 4  |                           |
|             | 0603        | EZJP0V270RA                      | 16                                  | 27                  | 20 max. [ 15 typ.] | 16.5 typ.                                  |                           |
| EZJZ0V420WA |             | 30                               | 42                                  | 56 max. [ 40 typ.]  | 45 typ.            | 10   |                           |
| EZJZ0V650DA |             | 40                               | 65                                  | 27 max. [ 22 typ.]  | 33 typ.            | 5  |                           |
| EZJP1V120KA |             | 6.7                              | 12                                  | 330 max. [250 typ.] | 290 typ.           | 20   |                           |
| EZJZ1V180JA |             | 11                               | 18                                  | 220 max. [180 typ.] | 210 typ.           | 20   |                           |
| EZJZ1V220JA |             | 13                               | 22                                  | 220 max. [160 typ.] | 185 typ.           | 20   |                           |
| EZJZ1V270GA |             | 16                               | 27                                  | 100 max. [ 85 typ.] | 100 typ.           | 20   |                           |
| EZJZ1V270EA |             | 16                               | 27                                  | 47 max. [ 33 typ.]  | 37 typ.            | 20   |                           |
| EZJZ1V270RA |             | 16                               | 27                                  | 20 max. [ 15 typ.]  | 16.5 typ.          | 3  |                           |
| EZJZ1V330GA |             | 26                               | 33                                  | 100 max. [ 85 typ.] | 100 typ.           | 20   |                           |
|             | EZJZ1V420FA | 30                               | 42                                  | 68 max. [ 55 typ.]  | 63 typ.            | 15   |                           |
|             | EZJZ1V650DA | 40                               | 65                                  | 27 max. [ 22 typ.]  | 33 typ.            | 5  |                           |

- Operating Temperature Range: -40 to 85 °C \* Recommend soldering method : Reflow soldering

|                           |  |
|---------------------------|--|
| Maximum Allowable Voltage | Maximum DC Voltage that can be applied continuously within the operating temperature range                                   |
| Varistor Voltage          | Varistor starting voltage between terminals at DC 1 mA, also known as Breakdown voltage                                      |
| Maximum Peak Current      | Maximum current that can be withstood under the standard pulse 8/20 μs, 2 times based  |
| Maximum ESD               | Maximum voltage that can be withstood under ESD based on IEC61000-4-2, 10 times (5 times of each positive-negative polarity) |

## Voltage vs. Current

### ● EZJP Series

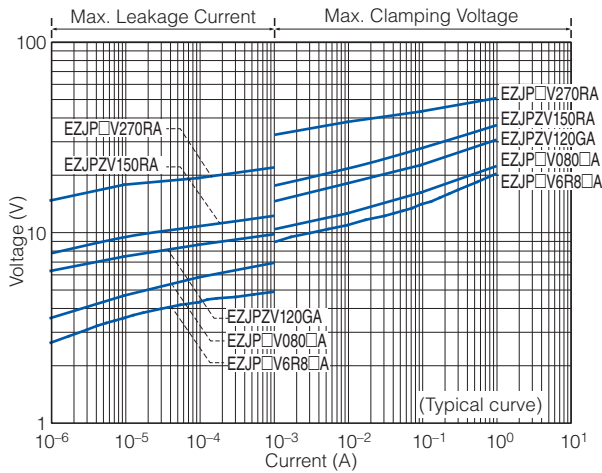

### ● EZJZ Series

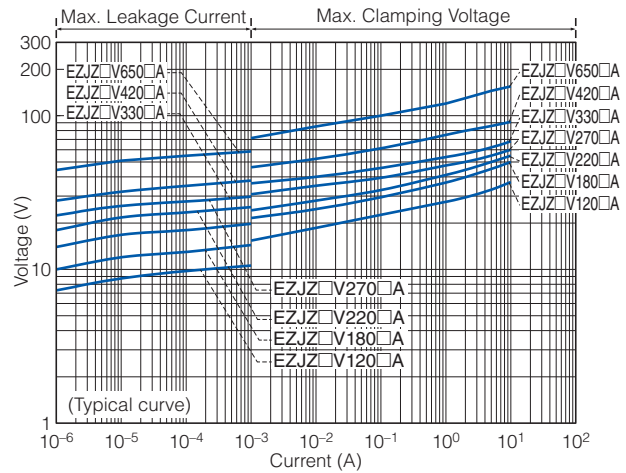

## Capacitance vs. Frequency

### ● EZJP Series

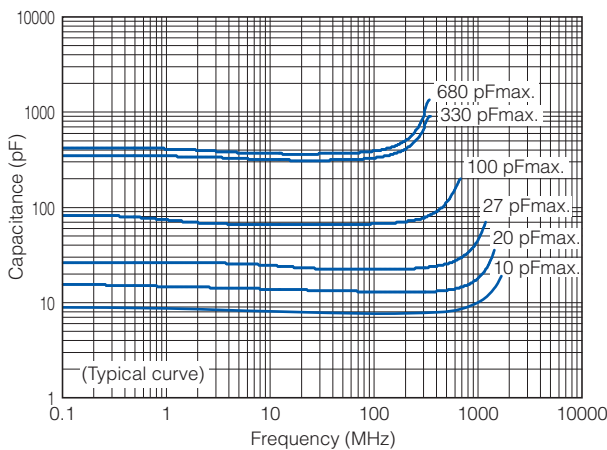

### ● EZJZ Series

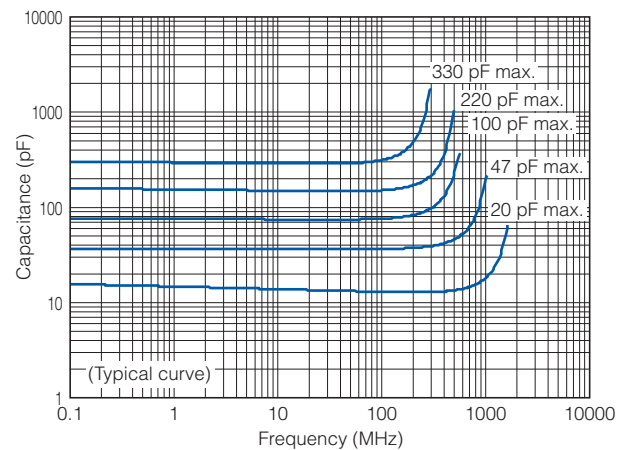

## Attenuation vs. Frequency

### ● EZJP Series

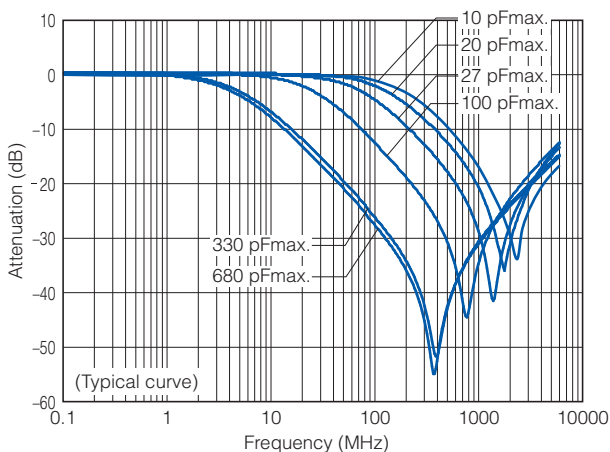

### ● EZJZ Series

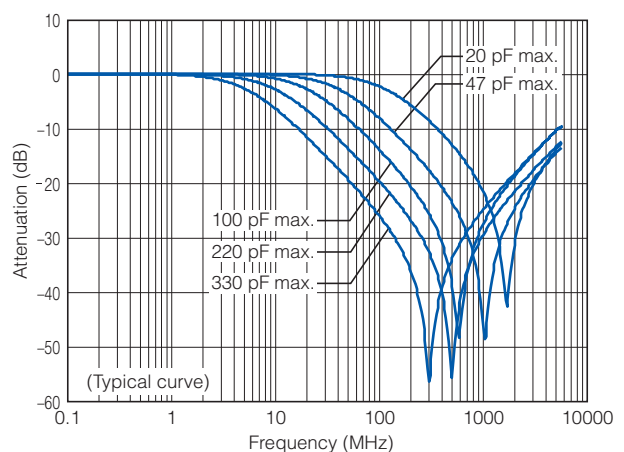

## Varistor Characteristics and Equivalent Circuit

A Multilayer Varistor does not have an electrical polarity like zener diodes and is equivalent to total 3 pcs. of 2 zener diodes and 1 capacitor.

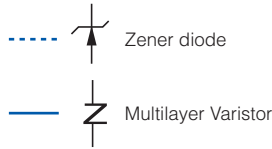
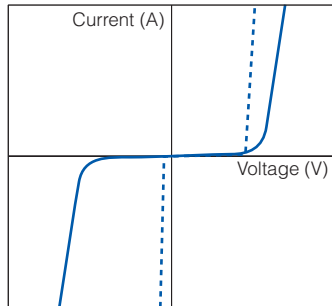

[Equivalent Circuit]

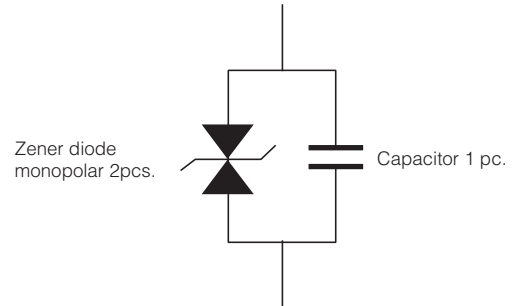

## ESD Suppressive Effects

Typical effects of ESD suppression

Test conditions: IEC61000-4-2\* Level 4 Contact discharge, 8 kV

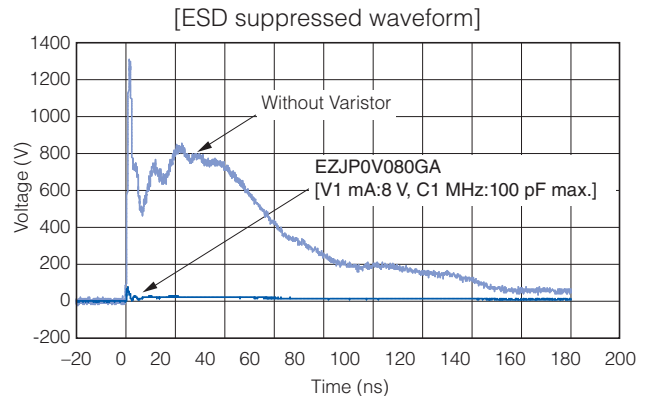
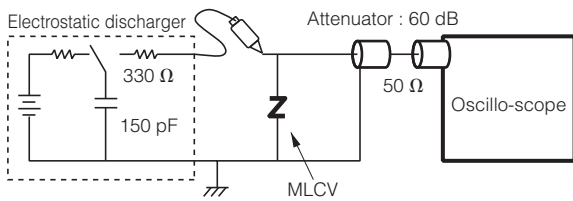

\* IEC61000-4-2 ... International Standard of the ESD testing method (HBM) for electronic equipment ability to withstand ESD generated from a human body. It sets 4 levels of severity

| Severity          | Level 1 | Level 2 | Level 3 | Level 4 |
|-------------------|---------|---------|---------|---------|
| Contact discharge | 2 kV    | 4 kV    | 6 kV    | 8 kV    |
| Air discharge     | 2 kV    | 4 kV    | 8 kV    | 15 kV   |

## Replacement of Zener diode

Replacing "Zener diode and Capacitor" with Multilayer Varistor saves both the mounting area and number of components used.

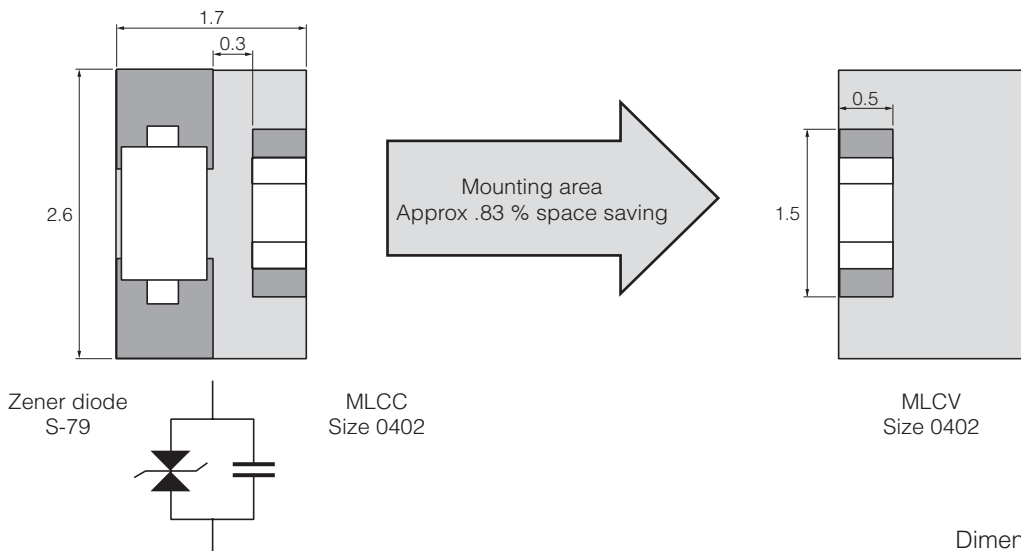

Dimensions in mm

## Recommended Applications

| Applications   | Series         | Circuit                                     | Series  |    |    |  |
|--|----------------|---|---|----|----|--|
|  |                |   | DC  | 1k | 1M | 1G (Hz)  |
| Mobile phones, DSC, PC, PDA, HDD TV (PDP, LC etc.), DVD, DVC, Game consoles, Audio equipment | Series EZJZ, P | Ultra low capacitance (Cap. : 3 pF or less) | [Bar chart showing high performance across all frequencies] |    |    | DC to GHz<br>Antenna, RF circuit, LVDS, USB, IEEE1394, HDMI etc. |
|  |                | Low capacitance (Cap. : 20 to 680 pF)       | [Bar chart showing high performance up to 1M Hz]            |    |    | DC to tens of Hz<br>PWR, SW, Audio terminals, LCD, RS232C, etc.  |
| PWR, Photoelectric sensors, SSR, Motors, Pressure sensors, Proximity switches                | Series EZJS    | High capacitance (Cap. : 1800 to 22000 pF)  | [Bar chart showing high performance up to 1k Hz]            |    |    | DC to several kHz<br>PWR, SW, Audio terminals etc.               |

## Applications

### ● Mobile Phone

· Audio lines

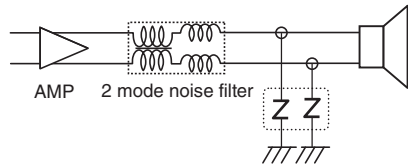

· LED

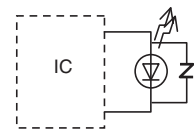

· SW/Keyboard

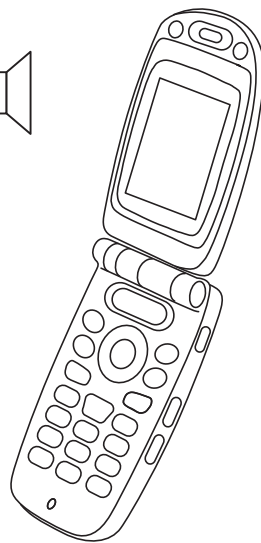
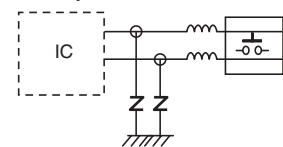

· LCD/Camera lines

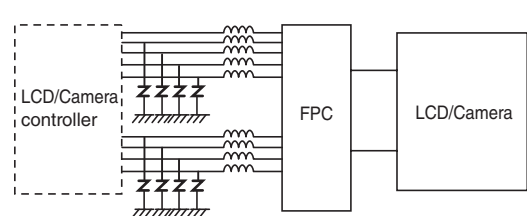

· I/O data lines

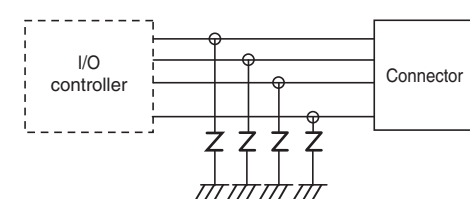

### ● USB1.1/2.0 lines

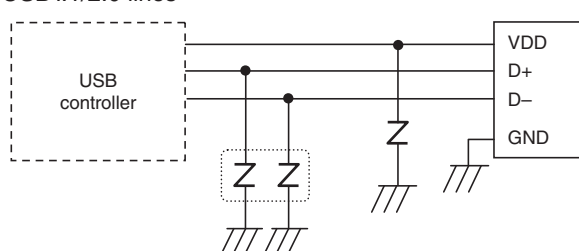

### ● IEEE1394 lines

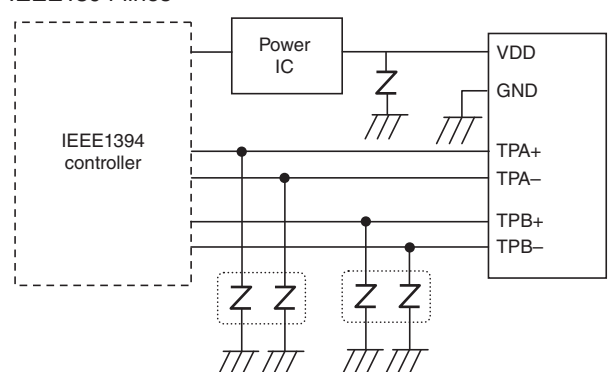

### ● HDMI lines

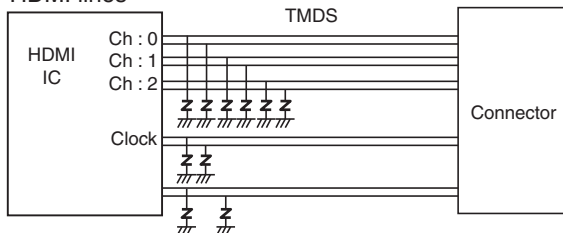

## Performance and Testing Methods

| Characteristics                      | Specifications                         | Testing Method   |      |             |        |   |                      |                |   |                |            |   |                      |                |   |                |            |
|--------------------------------------|--|--|------|-------------|--------|---|----------------------|----------------|---|----------------|------------|---|----------------------|----------------|---|----------------|------------|
| Standard test conditions             |  | Electrical characteristics shall be measured under the following conditions.<br>Temp. : 5 to 35 °C, Relative humidity : 85 % or less   |      |             |        |   |                      |                |   |                |            |   |                      |                |   |                |            |
| Varistor voltage                     | To meet the specified value.           | The Varistor voltage is the voltage ( $V_c$ , or $V_{cMA}$ ) between both end terminals of a Varistor when specified current ( $C_{mA}$ ) is applied to it. The measurement shall be made as quickly as possible to avoid heating effects.   |      |             |        |   |                      |                |   |                |            |   |                      |                |   |                |            |
| Maximum allowable voltage            | To meet the specified value.           | The maximum DC voltage that can be applied continuously to a varistor.   |      |             |        |   |                      |                |   |                |            |   |                      |                |   |                |            |
| Capacitance                          | To meet the specified value.           | Capacitance shall be measured at the specified frequency, bias voltage 0 V, and measuring voltage 0.2 to 2 Vrms.   |      |             |        |   |                      |                |   |                |            |   |                      |                |   |                |            |
| Maximum peak current                 | To meet the specified value.           | The maximum current measured (Varistor voltage tolerance is within $\pm 10\%$ ) when a standard impulse current of 8/20 $\mu$ seconds is applied twice with an interval of 5 minutes.  |      |             |        |   |                      |                |   |                |            |   |                      |                |   |                |            |
| Maximum ESD                          | To meet the specified value.           | The maximum ESD measured (while the varistor voltage is within $\pm 30\%$ of its nominal value) when exposed to ESD 10 times (five times for each positive-negative polarity) based on IEC61000-4-2.   |      |             |        |   |                      |                |   |                |            |   |                      |                |   |                |            |
| Solder ability                       | To meet the specified value.           | The part shall be immersed into a soldering bath under the conditions below.<br>Solder: H63A<br>Soldering flux : Ethanol solution of rosin (Concentration approx. 25 wt%)<br>Soldering temp. : 230 $\pm$ 5 °C<br>Period : 4 $\pm$ 1 s<br>Soldering position: Immerse both terminal electrodes until they are completely into the soldering bath.   |      |             |        |   |                      |                |   |                |            |   |                      |                |   |                |            |
| Resistance to soldering heat         | $\Delta V_c / V_c$ : within $\pm 10\%$ | After the immersion, leave the part for 24 $\pm$ 2 hours under the standard condition, then evaluate its characteristics. Soldering conditions are specified below:<br>Soldering conditions : 270 °C, 3 s / 260 °C, 10 s<br>Soldering position : Immerse both terminal electrodes until they are completely into the soldering bath.   |      |             |        |   |                      |                |   |                |            |   |                      |                |   |                |            |
| Temperature cycling                  | $\Delta V_c / V_c$ : within $\pm 10\%$ | After repeating the cycles stated below for specified number of times, leave the part for 24 $\pm$ 2 hours, then evaluate its characteristics.<br><br>Cycle : 5 cycles<br><table border="1" style="margin-left: auto; margin-right: auto;"> <thead> <tr> <th>Step</th> <th>Temperature</th> <th>Period</th> </tr> </thead> <tbody> <tr> <td>1</td> <td>Max. Operating Temp.</td> <td>30<math>\pm</math>3 min</td> </tr> <tr> <td>2</td> <td>Ordinary temp.</td> <td>3 min max.</td> </tr> <tr> <td>3</td> <td>Min. Operating Temp.</td> <td>30<math>\pm</math>3 min</td> </tr> <tr> <td>4</td> <td>Ordinary temp.</td> <td>3 min max.</td> </tr> </tbody> </table> | Step | Temperature | Period | 1 | Max. Operating Temp. | 30 $\pm$ 3 min | 2 | Ordinary temp. | 3 min max. | 3 | Min. Operating Temp. | 30 $\pm$ 3 min | 4 | Ordinary temp. | 3 min max. |
| Step                                 | Temperature                            | Period   |      |             |        |   |                      |                |   |                |            |   |                      |                |   |                |            |
| 1                                    | Max. Operating Temp.                   | 30 $\pm$ 3 min   |      |             |        |   |                      |                |   |                |            |   |                      |                |   |                |            |
| 2                                    | Ordinary temp.                         | 3 min max.   |      |             |        |   |                      |                |   |                |            |   |                      |                |   |                |            |
| 3                                    | Min. Operating Temp.                   | 30 $\pm$ 3 min   |      |             |        |   |                      |                |   |                |            |   |                      |                |   |                |            |
| 4                                    | Ordinary temp.                         | 3 min max.   |      |             |        |   |                      |                |   |                |            |   |                      |                |   |                |            |
| Biased Humidity                      | $\Delta V_c / V_c$ : within $\pm 10\%$ | After conducting the test under the conditions specified below, leave the part 24 $\pm$ 2 hours, then evaluate its characteristics.<br>Temp. : 40 $\pm$ 2 °C<br>Humidity : 90 to 95 %RH<br>Applied voltage : Maximum allowable voltage (Individually specified)<br>Period : 500+24 / 0 h   |      |             |        |   |                      |                |   |                |            |   |                      |                |   |                |            |
| High temperature exposure (dry heat) | $\Delta V_c / V_c$ : within $\pm 10\%$ | After conducting the test under the conditions specified below, leave the part 24 $\pm$ 2 hours, then evaluate its characteristics.<br>Temp. : Maximum operating temperature $\pm 3$ °C (Individually specified)<br>Applied voltage : Maximum allowable voltage (Individually specified)<br>Period : 500+24 / 0h   |      |             |        |   |                      |                |   |                |            |   |                      |                |   |                |            |