

# Panasonic

NEW

Amplifier Built-in  
Ultra-minute Photoelectric Sensor

EX-Z SERIES

CE  
Conforming to  
EMC Directive

UL US  
Recognition

The World's **No. 1**  
in Compactness

\* Among photoelectric sensors with built-in amplifier, as of June 2015 (survey by our company)

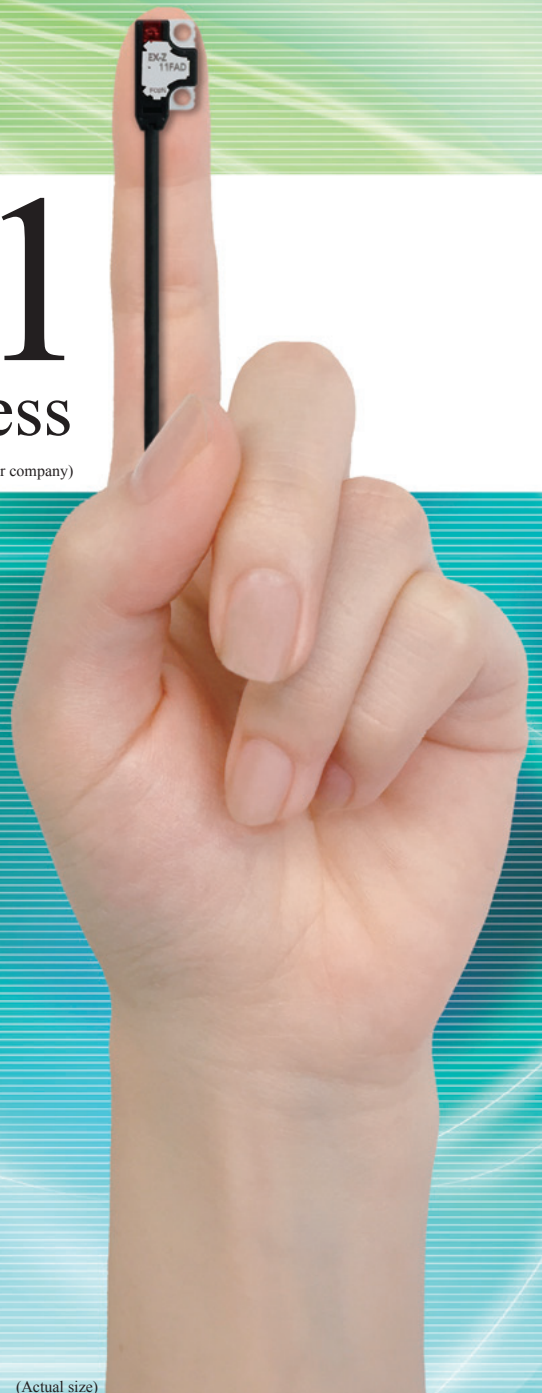

(Actual size)

# EX-Z SERIES

Ultra-minute Photoelectric Sensor **Amplifier Built-in**

## The World's Smallest\* Size

\* Among photoelectric sensors with built-in amplifier, as of June 2015 (survey by our company)

### Unit volume ratio reduced by about 50%\*

\* As compared to EX-10 series

The world's thinnest\* sensor dimension of 3 mm **0.118 in** has been achieved by utilizing new semiconductor packaging technology that does not use wire bonding. The small unit size allows installation of sensors in a narrow space where only a conventional fiber sensor head could be installed before. The built-in amplifier also saves on installation space.

\* Among photoelectric sensors with built-in amplifier, as of June 2015 (survey by our company)

#### EX-Z13□

Sensing range: 500 mm **19.685 in**  
 Repeatability: 0.05 mm **0.002 in** or less  
 Minimum sensing object:  
 ø1.0 mm **ø0.039 in** opaque object

#### EX-Z12□

Sensing range: 200 mm **7.874 in**  
 Repeatability: 0.03 mm **0.001 in** or less  
 Minimum sensing object:  
 ø0.5 mm **ø0.020 in** opaque object

#### EX-Z11□

Sensing range: 50 mm **1.969 in**  
 Repeatability: 0.02 mm **0.001 in** or less  
 Minimum sensing object:  
 ø0.3 mm **ø0.012 in** opaque object

Front sensing type

Side sensing type

Approx.  
**50% smaller**  
 in volume ratio  
 than EX-10



#### EX-Z11□F

W8 × H14 × D3 mm  
 W0.315 × H0.551 × D0.118 in

Approx.  
**35% smaller**  
 in volume ratio  
 than EX-10



#### EX-Z11□

W5.5 × H15.9 × D6.5 mm  
 W0.217 × H0.626 × D0.256 in

## Small-object sensing capability

Capable of sensing an extremely small ø0.3 mm **ø0.012 in** object without slit **EX-Z11□**

A slit is provided on the front side of the main sensor body. The sensor can detect a ø0.3 mm **ø0.012 in** object (the smallest-object sensing capability in the industry\*) without using an optional slit.

\* Among photoelectric sensors with built-in amplifier, as of June 2015 (survey by our company)

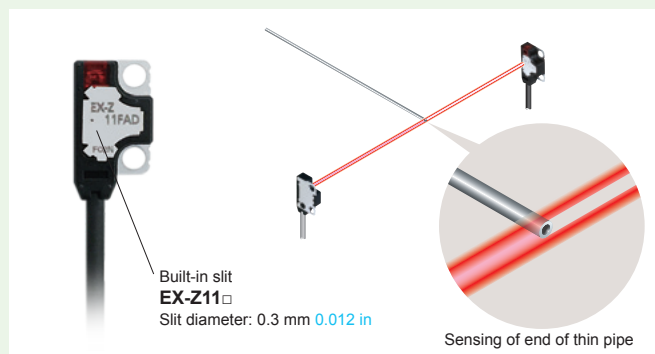

Capability to sense a small ø1.0 mm **ø0.039 in** object over long distance **EX-Z13□**

The high-brightness 4-element red LED provides strong light emission stably over a long period of time. In spite of the extremely small size, both front sensing and side sensing units can sense a small ø1.0 mm **ø0.039 in** object from a long distance of 500 mm **19.685 in**. Since the spotlight is clearly visible, the sensing position can be easily confirmed.

Clearly  
 visible  
 spotlight

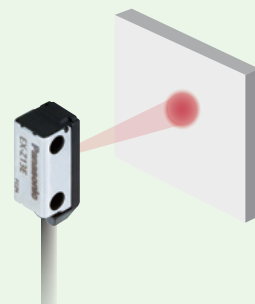



## A wide range of applications

### Inflection resistant cable type available for all models

Inflection resistant cable type with improved flex resistance is available for all models. Select the model suitable for your specific application. The standard type comes with lead wires with the same diameter as previous models, but the outside diameter of the cable is 2.0 mm **0.079 in** and thinner than the cables of the **EX-10** series. This facilitates cable routing.

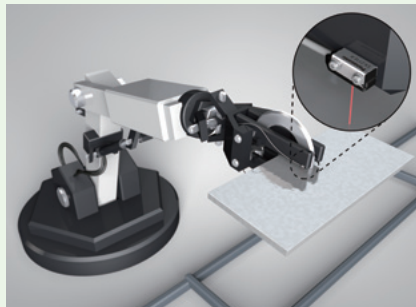

### IP67 protective structure

The sensors features an IP67 protective structure to allow their use in process lines where water is used or splashed.

Rust-resistant stainless steel sensor mounting brackets and screws are available.

Note: If water splashes on the sensor during sensing operation, it may sense water as an object.



## Options

### A variety of mounting brackets are available!

A spacer for mounting at the back (1 type) for through-wall sensing and sensor mounting brackets (3 types) are available to meet a diversity of sensor installation needs.

Spacer for mounting at the back (for front sensing type only)

Operation indicator (orange) can be checked from the rear side.

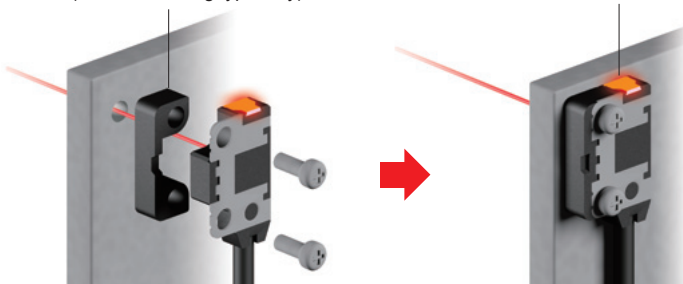

Through-wall detection

## Examples of applications

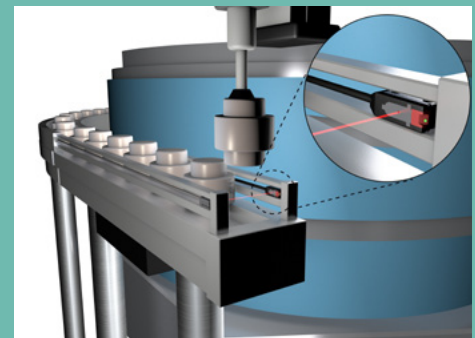

Detection of parts in parts feeder

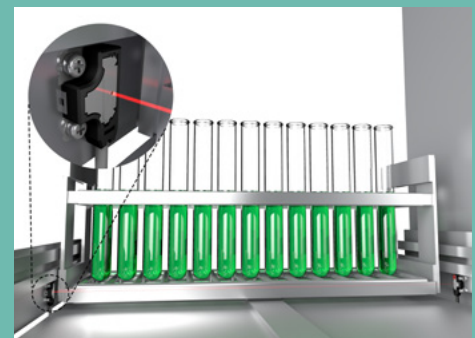

Detection of presence / absence of test tube tray



Detection of LED lead

## ORDER GUIDE

Type	Appearance	Sensing range	Model No. (Note)		Output operation
			NPN output	PNP output	
Thru-beam	Front sensing Infection resistant cable	50 mm 1.969 in	EX-Z11FA	EX-Z11FA-P	Light-ON
			EX-Z11FB	EX-Z11FB-P	Dark-ON
		200 mm 7.874 in	EX-Z12FA	EX-Z12FA-P	Light-ON
			EX-Z12FB	EX-Z12FB-P	Dark-ON
		500 mm 19.685 in	EX-Z13FA	EX-Z13FA-P	Light-ON
			EX-Z13FB	EX-Z13FB-P	Dark-ON
		50 mm 1.969 in	EX-Z11FA-R	EX-Z11FA-P-R	Light-ON
			EX-Z11FB-R	EX-Z11FB-P-R	Dark-ON
		200 mm 7.874 in	EX-Z12FA-R	EX-Z12FA-P-R	Light-ON
			EX-Z12FB-R	EX-Z12FB-P-R	Dark-ON
		500 mm 19.685 in	EX-Z13FA-R	EX-Z13FA-P-R	Light-ON
			EX-Z13FB-R	EX-Z13FB-P-R	Dark-ON
	Side sensing Infection resistant cable	50 mm 1.969 in	EX-Z11A	EX-Z11A-P	Light-ON
			EX-Z11B	EX-Z11B-P	Dark-ON
		200 mm 7.874 in	EX-Z12A	EX-Z12A-P	Light-ON
			EX-Z12B	EX-Z12B-P	Dark-ON
		500 mm 19.685 in	EX-Z13A	EX-Z13A-P	Light-ON
			EX-Z13B	EX-Z13B-P	Dark-ON
		50 mm 1.969 in	EX-Z11A-R	EX-Z11A-P-R	Light-ON
			EX-Z11B-R	EX-Z11B-P-R	Dark-ON
		200 mm 7.874 in	EX-Z12A-R	EX-Z12A-P-R	Light-ON
			EX-Z12B-R	EX-Z12B-P-R	Dark-ON
		500 mm 19.685 in	EX-Z13A-R	EX-Z13A-P-R	Light-ON
			EX-Z13B-R	EX-Z13B-P-R	Dark-ON

Note: Mounting bracket is not supplied with the sensor. Please select from the range of optional sensor mounting brackets (MS-EXZ-□).

Note: The model No. with "E" shown on the label affixed to the thru-beam type sensor is the emitter, "D" shown on the label is the receiver.

## OPTIONS

Designation	Model No.	Description
Sensor mounting bracket	MS-EXZ-1	L-shaped mounting bracket (SUS304) for front sensing and side sensing types (2 sets are required)
	MS-EXZ-2	Mounting bracket (SUS304) for front sensing type (2 sets are required)
	MS-EXZ-3	Mounting bracket (SUS304) for side sensing type (2 sets are required)
Spacer for mounting at the back	MS-EXZ-4	Spacer for mounting at the back (polyacetal) for front sensing type

### Sensor mounting bracket

• MS-EXZ-1

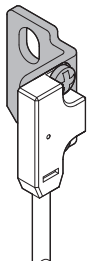

Material: Stainless steel (SUS304)  
Two M2 (length 4 mm 0.157 in) pan head screws and two M2 (length 8 mm 0.315 in) pan head screws are attached.

• MS-EXZ-2

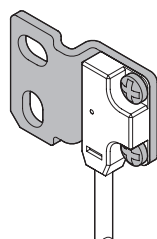

Material: Stainless steel (SUS304)  
Two M2 (length 4 mm 0.157 in) pan head screws are attached.

• MS-EXZ-3

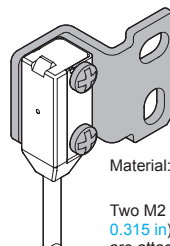

Material: Stainless steel (SUS304)  
Two M2 (length 8 mm 0.315 in) pan head screws are attached.

### Spacer for mounting at the back

• MS-EXZ-4

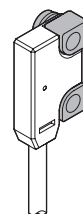

Material: Polyacetal  
M2 (length: 10 mm 0.394 in) screws, nuts, spring washers and flat washers are attached. (20 pieces each)

**SPECIFICATIONS**

Item	Type		Thru-beam									
			Front sensing		Side sensing		Front sensing		Side sensing			
	Model No. (Note 2)	Light-ON	EX-Z11FA(-P)(-R)	EX-Z11A(-P)(-R)	EX-Z12FA(-P)(-R)	EX-Z12A(-P)(-R)	EX-Z13FA(-P)(-R)	EX-Z13A(-P)(-R)	EX-Z12FB(-P)(-R)	EX-Z12B(-P)(-R)	EX-Z13FB(-P)(-R)	EX-Z13B(-P)(-R)
		Dark-ON	EX-Z11FB(-P)(-R)	EX-Z11B(-P)(-R)	EX-Z12FB(-P)(-R)	EX-Z12B(-P)(-R)	EX-Z13FB(-P)(-R)	EX-Z13B(-P)(-R)				
Sensing distance			50 mm <b>1.969 in</b>		200 mm <b>7.874 in</b>		500 mm <b>19.685 in</b>					
Minimum sensing object			$\varnothing 0.3$ mm <b><math>\varnothing 0.012</math> in</b> opaque object (Completely beam interrupted object) (Setting distance between emitter and receiver: 50 mm <b>1.969 in</b> )		$\varnothing 0.5$ mm <b><math>\varnothing 0.02</math> in</b> opaque object (Completely beam interrupted object) (Setting distance between emitter and receiver: 200 mm <b>7.874 in</b> )		$\varnothing 1.0$ mm <b><math>\varnothing 0.039</math> in</b> opaque object (Completely beam interrupted object) (Setting distance between emitter and receiver: 500 mm <b>19.685 in</b> )					
Hysteresis	—											
Repeatability (Perpendicular to sensing axis)			0.02 mm <b>0.001 in</b> or less		0.03 mm <b>0.001 in</b> or less		0.05 mm <b>0.002 in</b> or less					
Supply voltage	12 to 24 V DC $\pm 10$ % Ripple P-P 10 % or less											
Current consumption	Emitter: 10 mA or less, Receiver: 10 mA or less											
Output	<NPN output type> NPN open-collector transistor • Maximum sink current: 20 mA • Applied voltage: 30 V DC or less (between output and 0 V) • Residual voltage: 1.5 V or less (at 20 mA sink current)					<PNP output type> PNP open-collector transistor • Maximum source current: 20 mA • Applied voltage: 30 V DC or less (between output and +V) • Residual voltage: 1.5 V or less (at 20 mA source current)						
Short-circuit protection	Incorporated											
Response time	0.5 ms or less											
Operation indicator	Orange LED (Lights up when the sensing output is ON)											
Stability indicator	Green LED (Lights up under the stable light received condition or the stable dark condition)											
Environment resistance	Protection	IP67 (IEC)										
	Ambient temperature	-10 to +55 °C <b>14 to +131 °F</b> (No dew condensation or icing allowed), Storage: -30 to +70 °C <b>-22 to +158 °F</b>										
	Ambient humidity	35 to 85 % RH, Storage: 35 to 85 % RH										
	Ambient illuminance	Incandescent light: 5,000 lx at the light-receiving face										
	Voltage withstandability	1,000 V AC for one min. between all supply terminals connected together and enclosure										
	Insulation resistance	20 M $\Omega$ or more, with 250 V DC megger between all supply terminals connected together and enclosure										
	Vibration resistance	10 to 500 Hz frequency, 3 mm <b>0.118 in</b> amplitude in X, Y and Z directions for two hours each										
	Shock resistance	500 m/s <sup>2</sup> acceleration (50 G approx.) in X, Y and Z directions for three times each										
Light emitting element	Red LED (Peak emission wavelength: 650 nm <b>0.026 mil</b> , modulated)											
Grounding	Floating											
Material	Enclosure: PBT, Lens: Polycarbonate, Metallic part: Stainless steel (SUS304) (SUS301 for rear side of front sensing type)											
Cable (Note 3)	0.1 mm <sup>2</sup> 3-core (emitter: 2-core) cabtyre cable, 2 m <b>6.562 ft</b> long											
Cable extension	Extension up to total 50 m <b>164 ft</b> is possible with 0.3 mm <sup>2</sup> , or more, cable (both emitter and receiver).											
Weight	Net weight (each emitter and receiver): 15 g approx., Gross weight: 35 g approx.											
Accessories	M2 mounting screws: 1 set (front sensing type: 6 mm <b>0.236 in</b> in length; side sensing type: 10 mm <b>0.394 in</b> in length)											

Notes: 1) Where measurement conditions have not been specified precisely, the conditions used were an ambient temperature of +23°C **73°F**.

2) Model Nos. having the "-P" are PNP output type and model Nos. having the "-R" are inflection resistant cable type.

3) The inflection resistant cable type has a 0.1 mm<sup>2</sup> 3-core (thru-beam type emitter: 2-core) flexible cabtyre cable, 2 m **6.562 ft** long.

**PRECAUTIONS FOR PROPER USE**

- Never use this product as a sensing device for personnel protection.
- In case of using sensing devices for personnel protection, use products which meet laws and standards, such as OSHA, ANSI or IEC etc., for personnel protection applicable in each region or country.

**Mounting**

- In case of mounting on tapped holes (Unit: mm in)

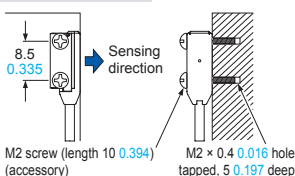
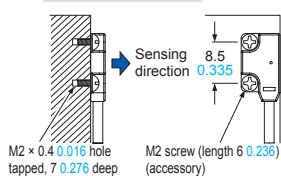
**Side sensing****Front sensing**

The tightening torque should be 0.2 N·m or less.

- In case of using attached screws and nuts (Unit: mm in)

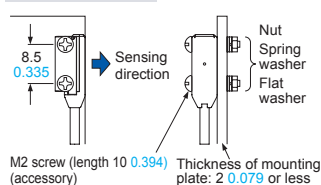
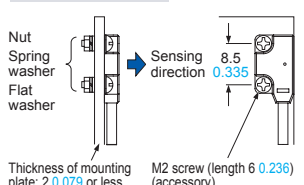
**Side sensing****Front sensing**

The tightening torque should be 0.2 N·m or less.

**Other**

- Do not use during the initial transient time (0.5 sec. approx.) after the power supply is switched on.

## I/O CIRCUIT DIAGRAMS

### NPN output type

#### I/O circuit diagram

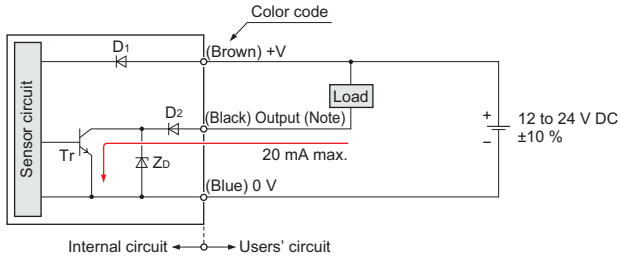

Note: The emitter does not incorporate the output.

Symbols ... D1: Reverse supply polarity protection diode  
 D2: Reverse output polarity protection diode  
 ZD: Surge absorption zener diode  
 Tr: NPN output transistor

### PNP output type

#### I/O circuit diagram

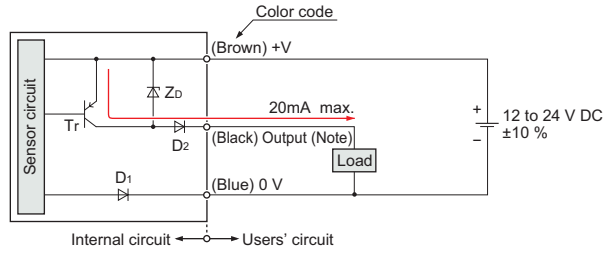

Note: The emitter does not incorporate the output.

Symbols ... D1: Reverse supply polarity protection diode  
 D2: Reverse output polarity protection diode  
 ZD: Surge absorption zener diode  
 Tr: PNP output transistor

## SENSING CHARACTERISTICS (TYPICAL)

### EX-Z11F □ EX-Z11 □

Thru-beam type

#### Parallel deviation

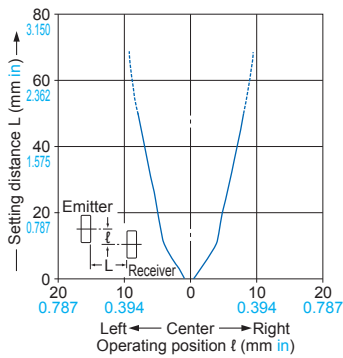

#### Angular deviation

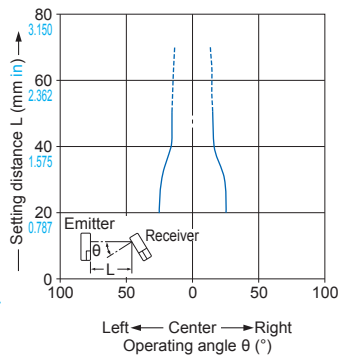

### EX-Z12F □ EX-Z12 □

Thru-beam type

#### Parallel deviation

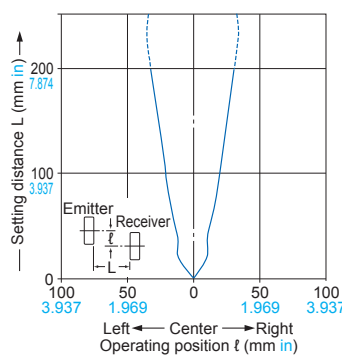

#### Angular deviation

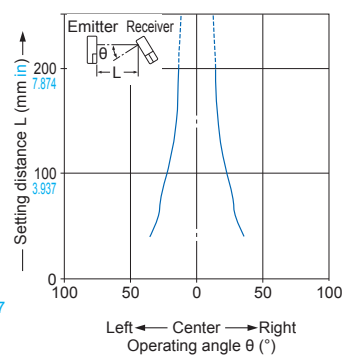

### EX-Z13F □ EX-Z13 □

Thru-beam type

#### Parallel deviation

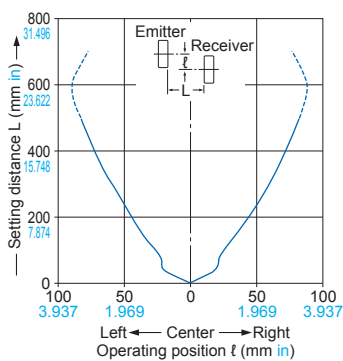

#### Angular deviation

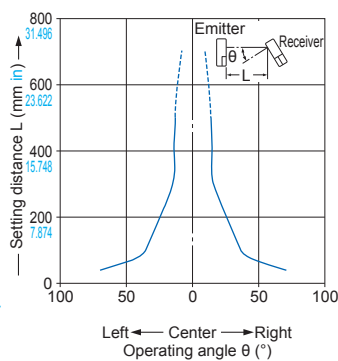

**DIMENSIONS (Unit: mm in)**

The CAD data can be downloaded from the website.

**EX-Z11F □ EX-Z12F □ EX-Z13F □**

**Sensor**

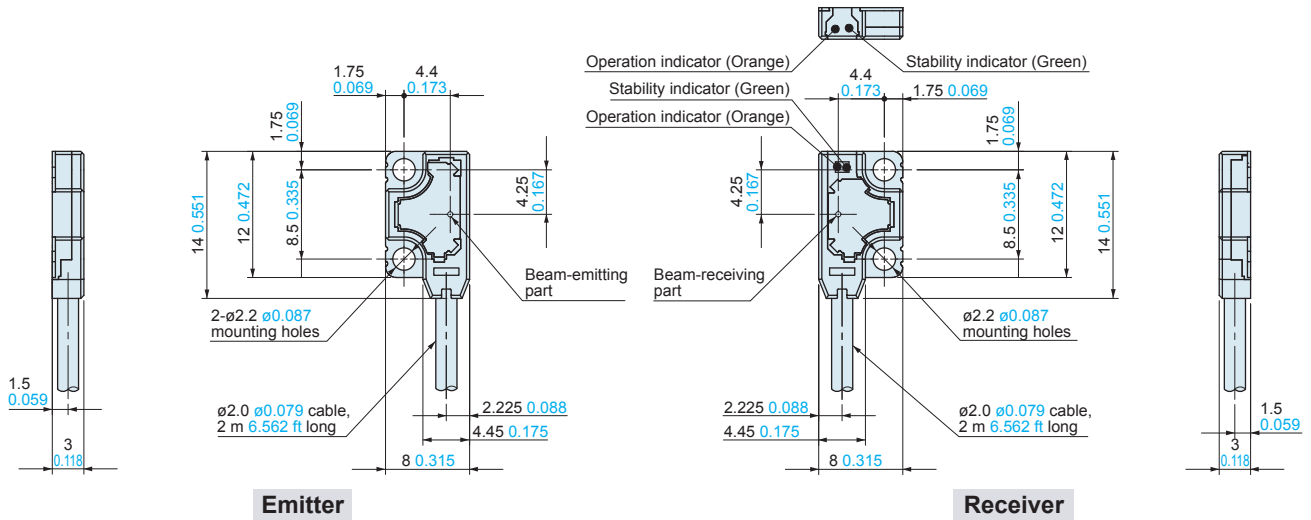

**EX-Z11 □ EX-Z12 □ EX-Z13 □**

**Sensor**

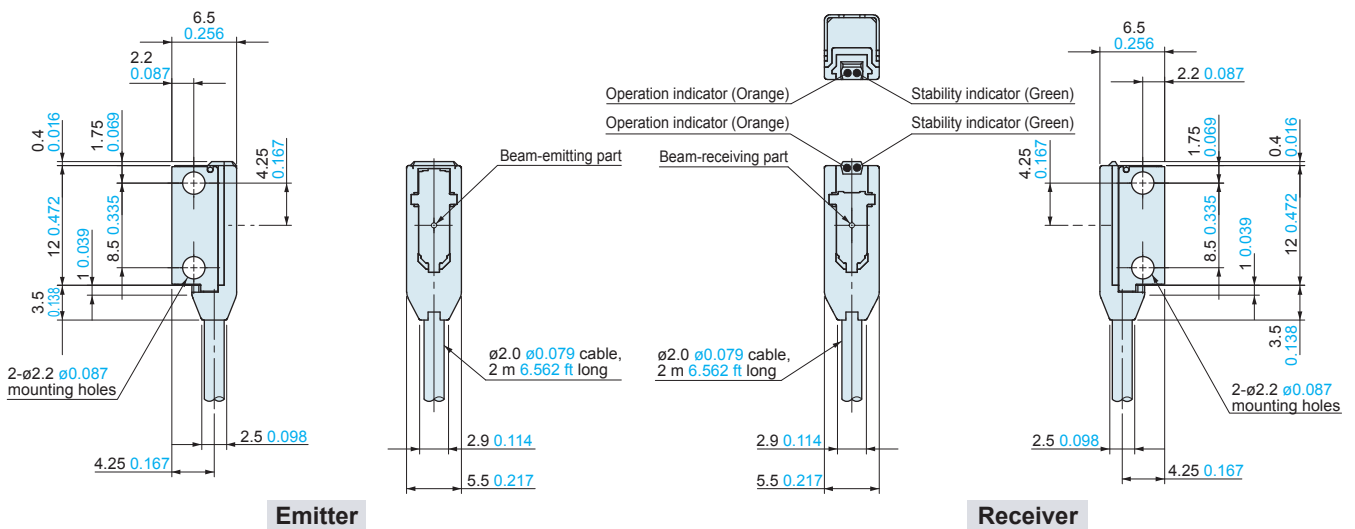

**MS-EXZ-1** Sensor mounting bracket (Optional)

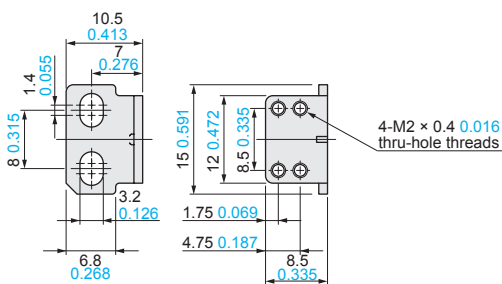

Material: Stainless steel (SUS304)  
Two M2 (length 4 mm  $0.157$  in) pan head screws and two M2 (length 8 mm  $0.315$  in) pan head screws are attached.

**MS-EXZ-2** Sensor mounting bracket (Optional)

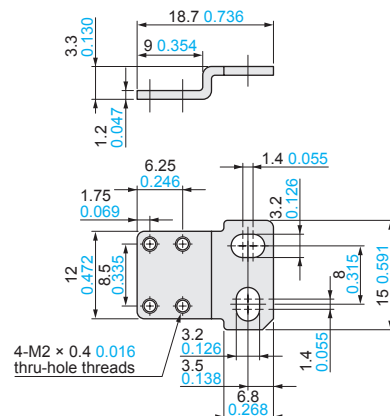

Material: Stainless steel (SUS304)  
Two M2 (length 4 mm  $0.157$  in) pan head screws are attached.



**DIMENSIONS (Unit: mm in)**

The CAD data can be downloaded from the website.

**MS-EXZ-3 Sensor mounting bracket (Optional)**

**MS-EXZ-4 Spacer for mounting at the back (Optional)**

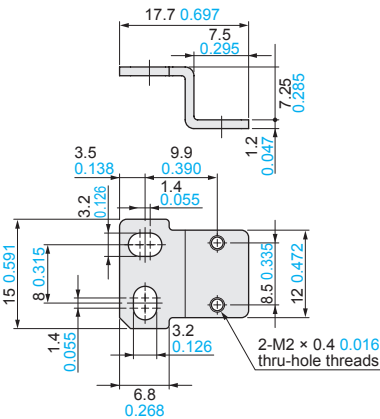

Material: Stainless steel (SUS304)  
Two M2 (length 8 mm 0.315 in) pan head screws are attached.

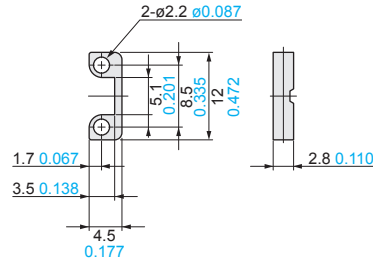

Material: Polyacetal  
Set of 10 pieces  
M2 (length: 10 mm 0.394 in) screws, nuts, spring washers and flat washers are attached. (20 pieces each)

**EX Family Products**

<p>Ultra-slim Photoelectric Sensor <small>Amplifier Built-in</small></p> <p><b>EX-10</b>SERIES Ver.2</p> 	<p>Ultra-compact Photoelectric Sensor <small>Amplifier Built-in</small></p> <p><b>EX-20</b>SERIES Ver.2</p> 	<p>Threaded Miniature Photoelectric Sensor <small>Amplifier Built-in</small></p> <p><b>EX-30</b>SERIES Ver.2</p> 
<p><b>Ultra-thin dimension</b></p> <ul style="list-style-type: none"> <li>• Only 3.5 mm 0.138 in thick</li> <li>• Long sensing range of 1 m 3.281 ft</li> <li>• High speed response of 0.5 ms</li> </ul>	<p><b>Easy installation with M3 screws</b></p> <ul style="list-style-type: none"> <li>• Equipped with sensitivity adjuster</li> <li>• Long sensing range of 2 m 6.562 ft</li> <li>• Red spotlight for easy confirmation of sensing point</li> </ul>	<p><b>One-point mounting</b></p> <ul style="list-style-type: none"> <li>• Simple design with sensing axis corresponding with mounting hole</li> <li>• Can be installed using the same thread size (M4 for thru-beam type, M6 for reflective type) as that of standard fiber</li> </ul>

**Disclaimer**

The applications described in the catalog are all intended for examples only. The purchase of our products described in the catalog shall not be regarded as granting of a license to use our products in the described applications. We do NOT warrant that we have obtained some intellectual properties, such as patent rights, with respect to such applications, or that the described applications may not infringe any intellectual property rights, such as patent rights, of a third party.

Please contact:

**Panasonic Industrial Devices SUNX Co., Ltd.**

2431-1 Ushiyama-cho, Kasugai-shi, Aichi, 486-0901, Japan  
Global Sales Department  
■Telephone: +81-568-33-7861 ■Facsimile: +81-568-33-8591  
panasonic.net/id/pidsx/global

