



The Future of Analog IC Technology®

EVQ4480-V-00A

6A,36V, Step-Down Converter for Automotive, AEC-Q100 Qualified Evaluation Board

DESCRIPTION

The EVQ4480-V-00A Evaluation Board is designed to demonstrate the capabilities of MPS' MPQ4480, which is a high-frequency, synchronous rectified, step-down, switch-mode converter. It achieves 6A output current over a wide input-supply range with excellent load and line regulation over a wide input-supply range. The MPQ4480 has synchronous-mode operation for higher efficiency over the output-load range.

Fault condition protection includes hiccup current limiting, OVP, ground short to battery protection and thermal shutdown (TSD).

The MPQ4480 requires a minimum number of readily available, standard, external components. The MPQ4480 is available in a QFN25 (4mmx5mm) package

ELECTRICAL SPECIFICATION

Parameter	Symbol	Value	Units
Input Voltage	V_{IN}	12	V
Output Voltage	V_{OUT}	5	V
Output Current	I_{OUT}	6	A
Switching Frequency	F_s	440	kHz

FEATURES

- 4.2V to 36V Operating Input-Voltage Range
- 6A Output Current
- Internal Auto EN Pull-up
- 20mΩ/15mΩ Low $R_{DS(ON)}$ Internal Buck Power MOSFETs
- Integrated 4mΩ Ground Sensing Resistor
- Frequency Adjustable (235kHz to 2.2MHz)
- CC Output-Current Limit, 3 level adjustable, 2.75A/3.75A/7.5A
- Forced PWM Mode
- Support 300kHz to 2.1MHz Frequency SYNC Input
- EN Shutdown Discharge
- Low Dropout Mode
- Battery Short to Ground Protect Driver
- Output Over Voltage Protection
- Adjustable Line Drop Compensation
- Available in AEC-Q100 Grade 1

APPLICATIONS

- Automotive Infotainment System
- Automotive USB Hub

All MPS parts are lead-free and adhere to the RoHS directive. For MPS green status, please visit MPS website under Products, Quality Assurance page.

"MPS" and "The Future of Analog IC Technology", are Registered Trademarks of Monolithic Power Systems, Inc.

EVQ4480-V-00A EVALUATION BOARD

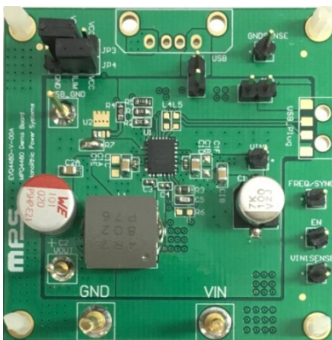

(L × W × H) 50mm × 50mm × 18mm

Board Number	MPS IC Number
EVQ4480-V-00A	MPQ4480GV-AEC1

Efficiency vs. Load Current

$V_{OUT}=5V$, $F_s=440kHz$, $L=4.7\mu H$

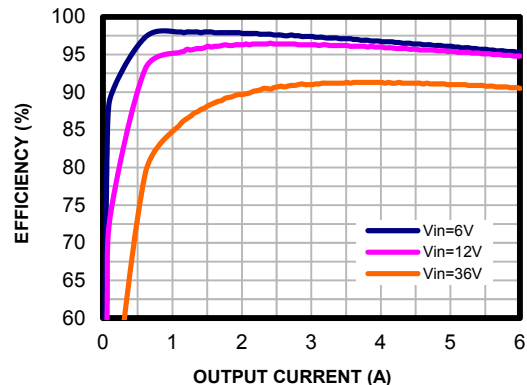

EVALUATION BOARD SCHEMATIC

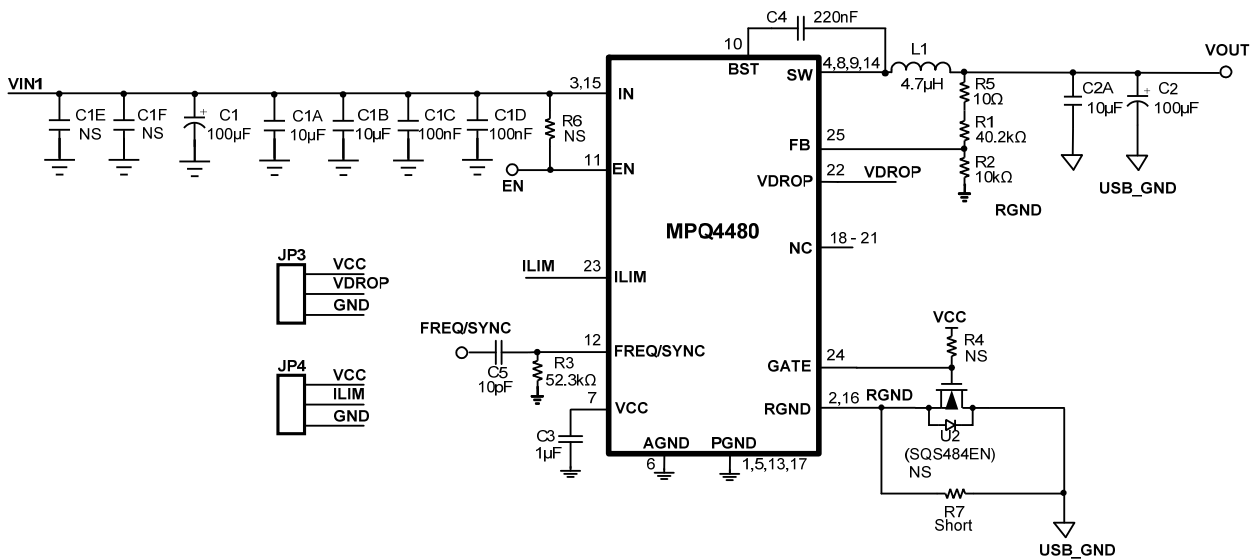
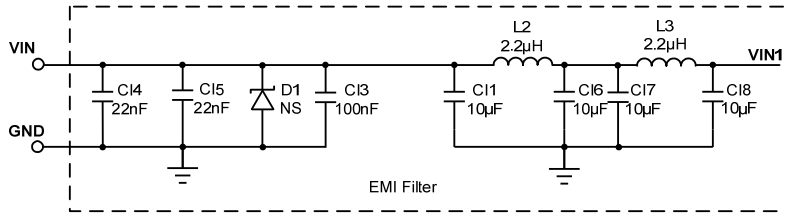

Default setting: ILIM =VCC, through a jumper; VDROP=GND, through a jumper.



EVQ4480-V-00A BILL OF MATERIALS

Qty	RefDes	Value	Description	Package	Manufacturer	Manufacturer_P/N
7	C1A,C1B, C1I, C16, C17,C18, C2A	10 μ F	Ceramic Cap., 50V, X5R	0805	Murata	GRM21BR61H106KE43L
1	C13	100nF	Ceramic Cap., 50V, X7R	0603	Murata	GRM188R71H104KA93D
2	C14, C15	22nF	Ceramic Cap., 50V, X5R	0603	Murata	GRM188R71H223KA01D
1	C1	100 μ F	Electrolytic Cap., 100 μ F 35V	SMD	CHEMICON	EMZJ350ADA101MF80G
2	C1C, C1D	100nF	Ceramic Cap., 50V, X7R	0402	Murata	GRM155R71H104ME14D
1	C2	100 μ F	Polymer Cap., 100 μ F 20V,	DIP	WE	875115452003
1	C3	1 μ F	Ceramic Cap., 16V, X6S	0402	Murata	GRM155C81C105KE11D
1	C4	220nF	Ceramic Cap., 16V, X5R	0402	WE	885012105017
1	C5	10pF	Ceramic Cap., 50V, NP0	0603	WE	885012006051
1	R1	40.2k	Film Res, 1%, 0603, 40K2	0603	YAGEO	RC0603FR-0740K2L
1	R2	10k	Film Res, 1%, 0603, 10K	0603	YAGEO	RC0603FR-0710KL
1	R3	52.3k	Film Res, 1%, 0603, 52K3	0603	YAGEO	RC0603FR-0752K3L
1	R5	10	Film Res, 1%, 0603, 10R	0603	YAGEO	RC0603JR-0710RL
1	R7	Short	Film Res, 1%, 0805, Short	0805		
1	L1	4.7 μ H	Inductor, RDC=8.3m Ω , Isat=15.7A	SMD	Cyntec	VCHA105D-4R7MS6-89
2	L2, L3	2.2 μ H	Inductor, RDC=35m Ω , Isat=6.2A	SMD	WE	74438356022
1	U1	MPQ44 80	Step-down converter	QFN- 25(4mmx5 mm)	MPS	MPQ4480GV-AEC1
0	C1E, C1F, D1, R4, R6, U2	NS				

EVB TEST RESULTS

Performance waveforms are tested on the evaluation board.

$V_{IN} = 12V$, $V_{OUT} = 5V$, $L = 4.7\mu H$, $F_S = 440kHz$, $T_A = 25^\circ C$, unless otherwise noted.

Output Ripple

$F_S = 440kHz$, $L = 4.7\mu H$, $I_{OUT} = 0A$

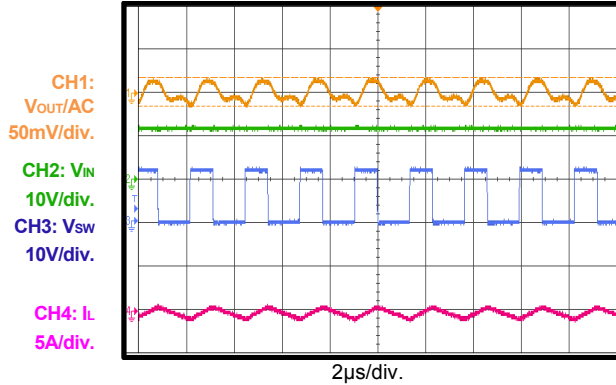

Output Ripple

$F_S = 440kHz$, $L = 4.7\mu H$, $I_{OUT} = 6A$

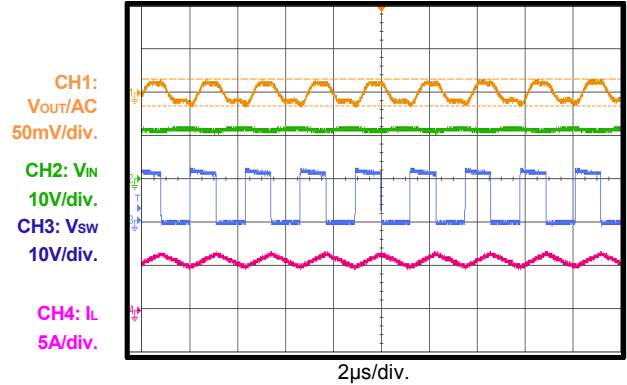

Output Ripple

$F_S = 2.2MHz$, $L = 2.2\mu H$, $I_{OUT} = 0A$

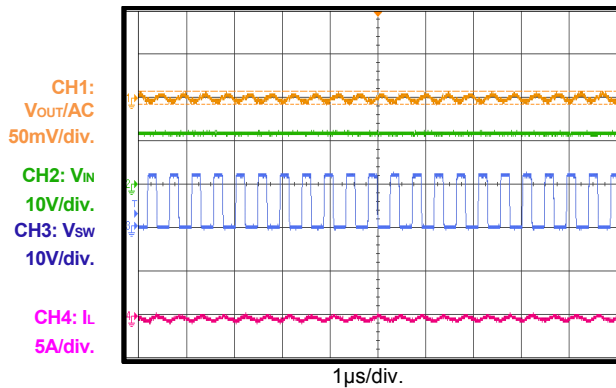

Output Ripple

$F_S = 2.2MHz$, $L = 2.2\mu H$, $I_{OUT} = 6A$

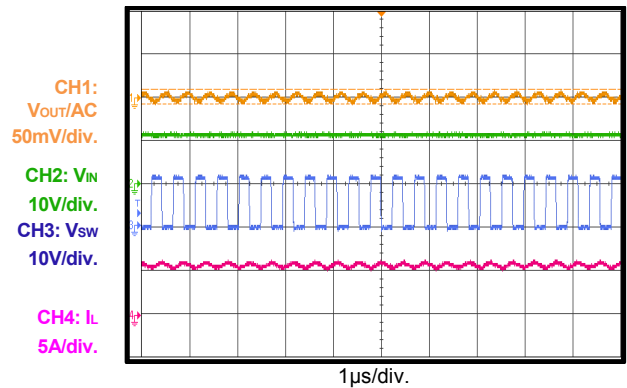

Power Start-Up

$I_{OUT} = 0A$

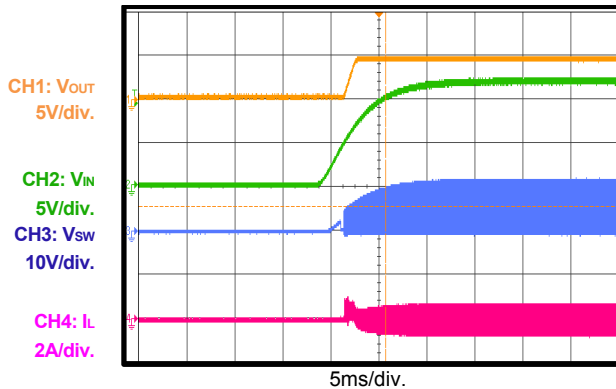

Power Start-Up

$I_{OUT} = 6A$

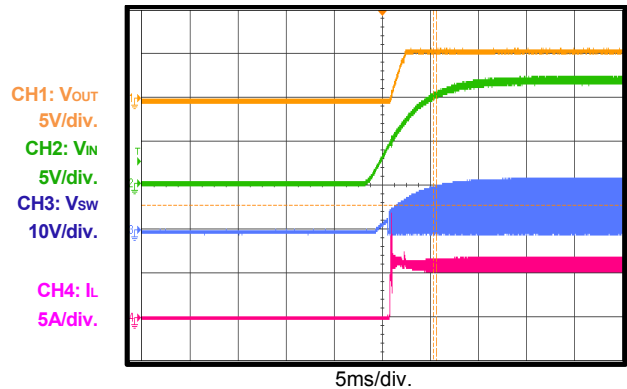

EVB TEST RESULTS (continued)

Performance waveforms are tested on the evaluation board.

$V_{IN} = 12V$, $V_{OUT} = 5V$, $L = 4.7\mu H$, $F_S = 440kHz$, $T_A = 25^\circ C$, unless otherwise noted.

Power Shutdown

$I_{OUT}=0A$

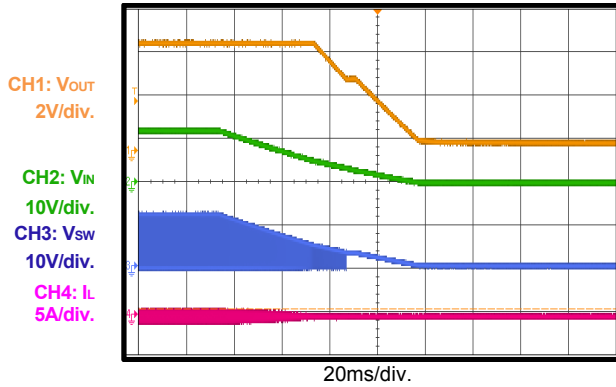

Power Shutdown

$I_{OUT}=6A$

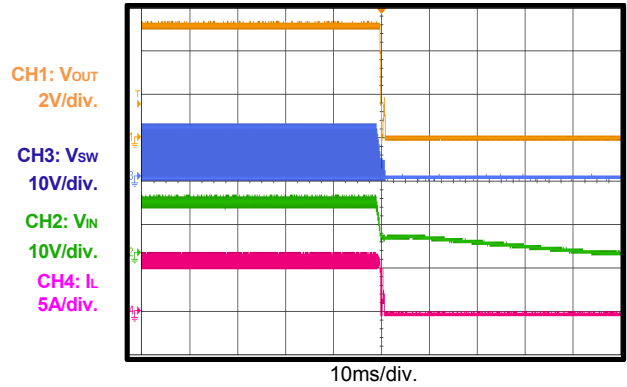

EN Start-Up

$I_{OUT}=0A$

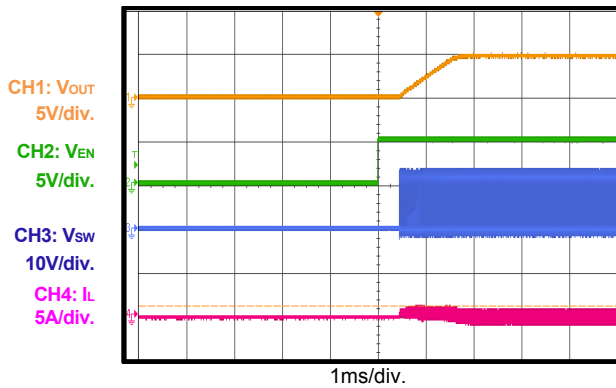

EN Start-Up

$I_{OUT}=6A$

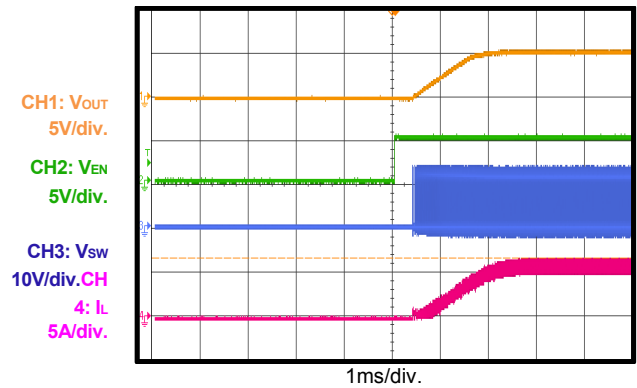

EN Shutdown

$I_{OUT}=0A$

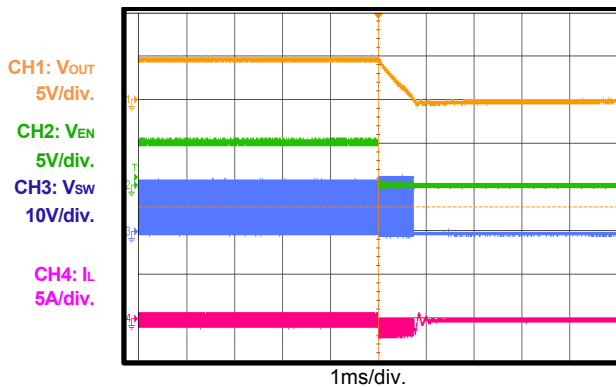

EN Shutdown

$I_{OUT}=6A$

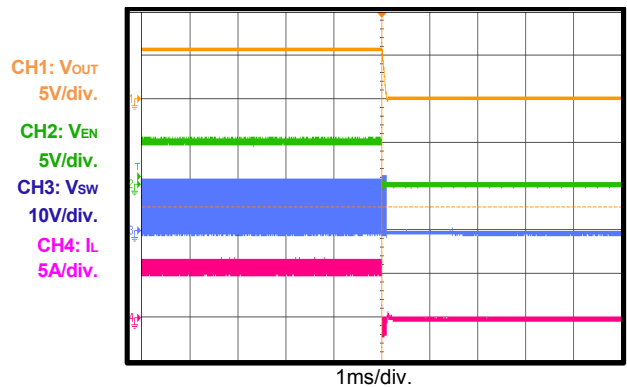

EVB TEST RESULTS *(continued)*

Performance waveforms are tested on the evaluation board.

$V_{IN} = 12V$, $V_{OUT} = 5V$, $L = 4.7\mu H$, $F_s = 440kHz$, $T_A = 25^\circ C$, unless otherwise noted.

VOUT short to USB_GND entry
 $I_{OUT}=0A$

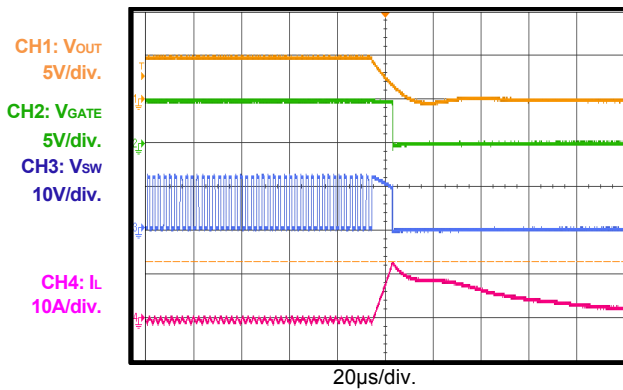

VOUT short to USB_GND Steady State
 $I_{OUT}=0A$

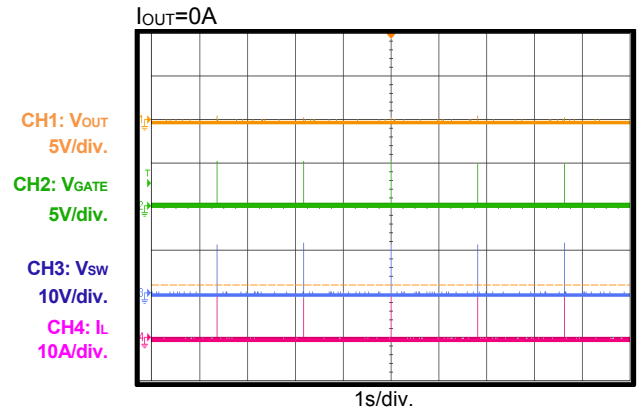

VOUT short to USB_GND Recovery
 $I_{OUT}=0A$

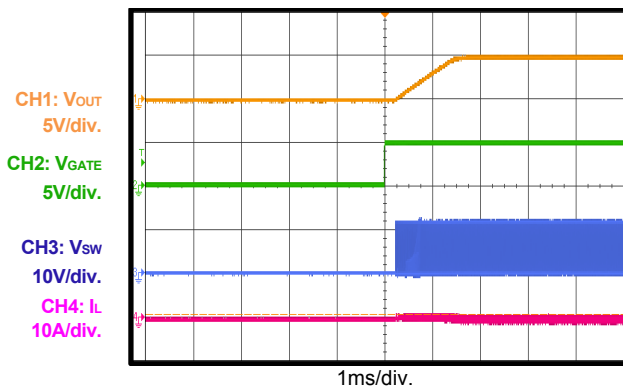

USB_GND short to Battery entry and Recovery
 $I_{OUT}=0A$

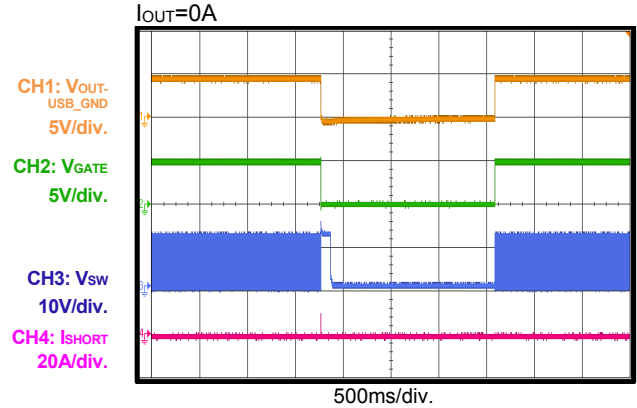

Sync Function

$F_s=300kHz$, $L=4.7\mu H$, $I_{OUT}=6A$

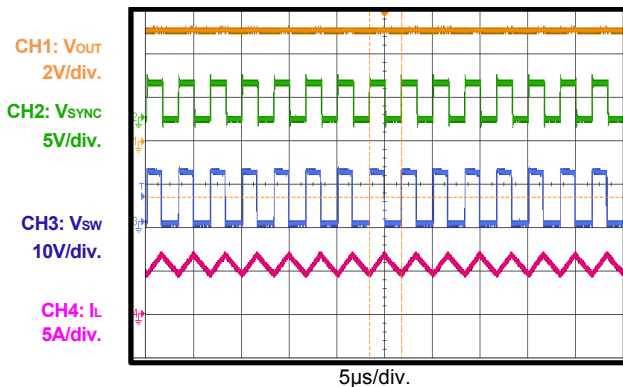

Sync Function

$F_s=2.1MHz$, $L=2.2\mu H$, $I_{OUT}=6A$

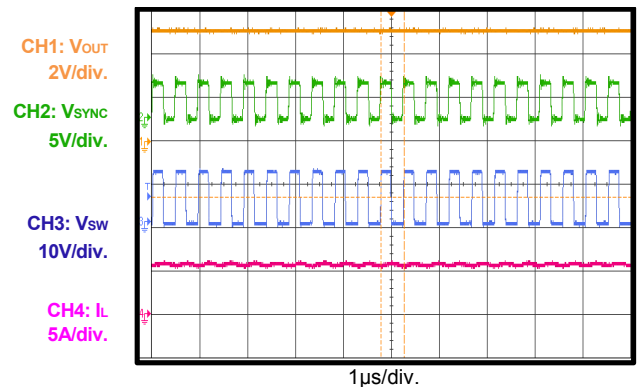

EVB TEST RESULTS *(continued)*

Performance waveforms are tested on the evaluation board.

$V_{IN} = 12V$, $V_{OUT} = 5V$, $L = 4.7\mu H$, $F_s = 440kHz$, $T_A = 25^\circ C$, unless otherwise noted.

CC Mode Over-Current-Protection Steady State

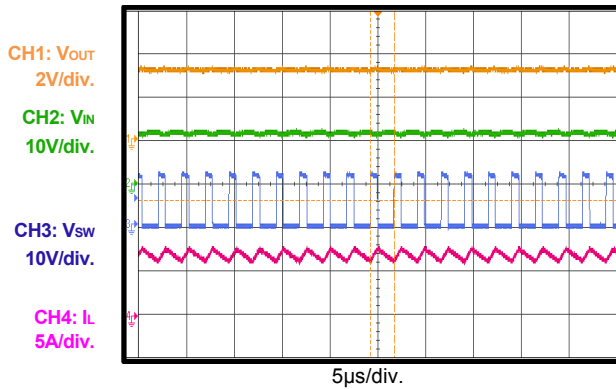

Low Dropout Mode

$V_{IN} = 5V$, $V_{OUT} = 4.93V$, $I_{OUT} = 0A$

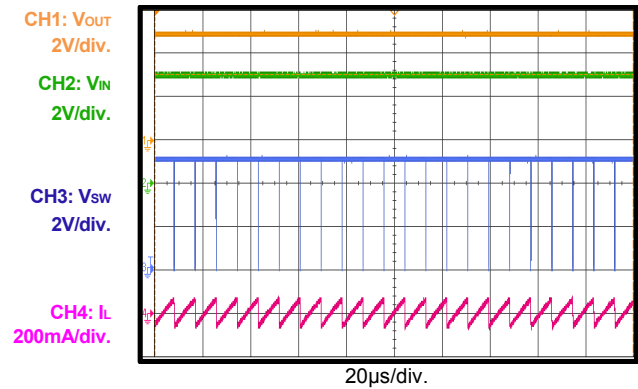

Load Transient

$I_{OUT} = 0$ to $3A$, $2.5A/\mu s$, $V_{DROP} = GND$
Line drop compensation = $73mV@3A$

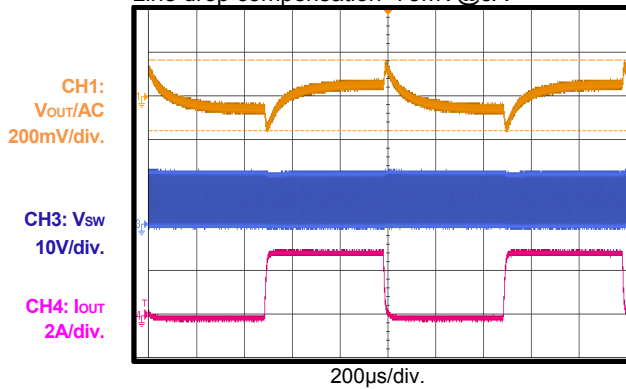

QUICK START GUIDE

1. Preset Power Supply $V_{IN} = 12V$.
2. Turn Power Supply off.
3. Connect Power Supply terminals to:
 - a. Positive (+): VIN
 - b. Negative (-): GND
4. Connect Load to:
 - a. Positive (+): VOUT
 - b. Negative (-): USB_GND
5. Output line drop compensation can be set up by JP3 (find details in datasheet), default setting is VDROP=GND:

Typically, for 6A output current, VDROP=GND for 145mV line drop compensation; VDROP=Float for 784mV line drop compensation; VDROP=VCC for 1628mV line drop compensation.

Output CC current limit can be set up JP4, default setting is ILIM=VCC:
ILIM=VCC for 6A continuous; ILIM=Float for 3A continuous; ILIM=GND for 2.4A continuous.
6. Turn Power Supply on after making connections. The board will automatically start up.

NOTICE: The information in this document is subject to change without notice. Please contact MPS for current specifications. Users should warrant and guarantee that third party Intellectual Property rights are not infringed upon when integrating MPS products into any application. MPS will not assume any legal responsibility for any said applications.