

3.4 mm×2.9 mm SMD Light Touch Switches

Type: **EVPAY**

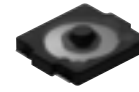

■ Features

- External dimensions: 3.4 mm×2.9 mm, Height 0.7 mm
- High operability
Equipped with an actuator (push plate)
- IP67 characteristic

■ Recommended Applications

- Operation switches for portable electronic equipment
(Mobile phone, Portable audio)

■ Explanation of Part Numbers

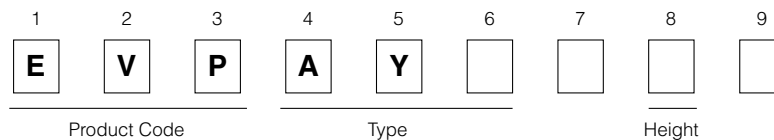

■ Specifications

Type		Snap action/Push-on type SPST
Electrical	Rating	10 μ A 2 Vdc to 20 mA 15 Vdc (Resistive load)
	Contact Resistance	500 m Ω max.
	Insulation Resistance	50 M Ω min. (at 100 Vdc)
	Dielectric Withstanding Voltage	250 Vac for 1 minute
	Bouncing	10 ms max. (ON, OFF)
Mechanical	Operating Force	1.6 N, 2.4 N
	Travel	0.15 mm
Endurance	Operating Life	500000 cycles min.
IP67(*1)	IP6x (Dust resistance)	Dust : Talc (Type4) 8h
	IPx7 (Water resistance)	Immersion depth : 1m 30min.
Operating Temperature		-40 °C to +85 °C
Storage Temperature		-40 °C to +85 °C (Bulk) -20 °C to +60 °C (Taping)
Minimum Quantity/Packing Unit		8000 pcs. Embossed Taping (Reel Pack)
Quantity/Carton		40000 pcs.

Note: Non washable

(*1) IP67 : Switch shall not be operated during test.





Water or dust ingress shall be limited enough to prevent deleterious effect to the switch function.

However, IP67 shall be guaranteed under single product state,

then there is a possibility that IP67 performance become impaired depending on your mounting condition or usage.

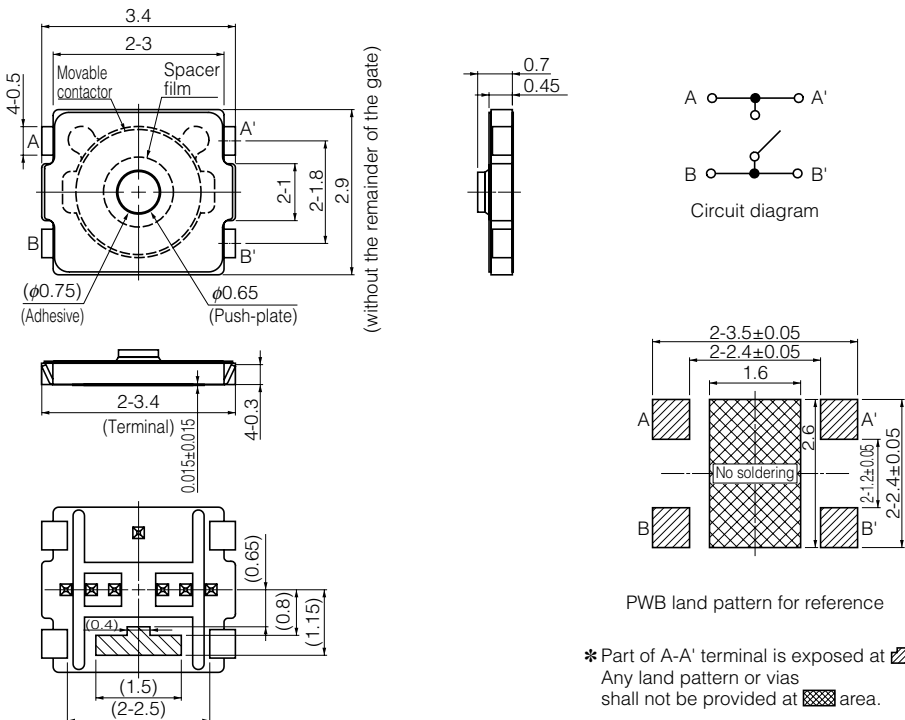
So, please ask us in advance, if the switch is applied to important usage for water and dust resistant.

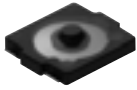
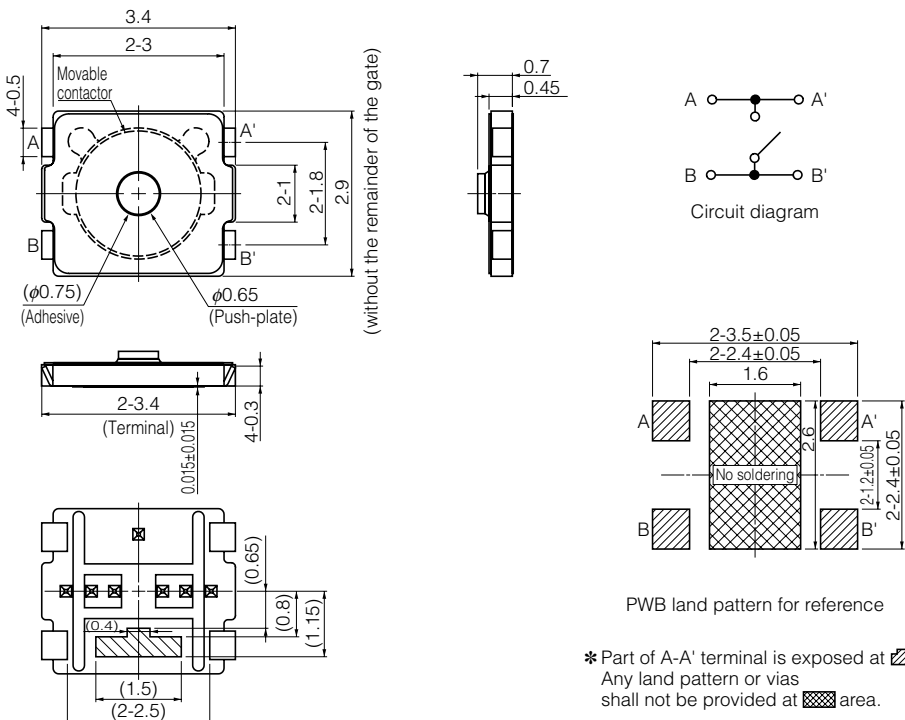
■ Dimensions in mm (not to scale)

<p>No. 1</p> <p>EVPAY</p> <p>(Embossed Taping)</p> 	<p>General dimension tolerance : ± 0.1 () dimensions are reference dimensions.</p>  <p>(without the remainder of the gate)</p> <p>PWB land pattern for reference</p> <p>* Part of A-A' terminal is exposed at  area. Any land pattern or vias shall not be provided at  area.</p>		
<p>Part Numbers</p> <p>EVPAYF1BA</p>	<p>Operating Force</p> <p>1.6 N</p>	<p>Height</p> <p>0.7 mm</p>	<p>Operating Life</p> <p>500000 cycles</p>
<p>No. 2</p> <p>EVPAY</p> <p>(Embossed Taping)</p> 	<p>General dimension tolerance : ± 0.1 () dimensions are reference dimensions.</p>  <p>(without the remainder of the gate)</p> <p>PWB land pattern for reference</p> <p>* Part of A-A' terminal is exposed at  area. Any land pattern or vias shall not be provided at  area.</p>		
<p>Part Numbers</p> <p>EVPAYG0BA</p>	<p>Operating Force</p> <p>2.4 N</p>	<p>Height</p> <p>0.7 mm</p>	<p>Operating Life</p> <p>500000 cycles</p>

■ Recommended Reflow Soldering Conditions

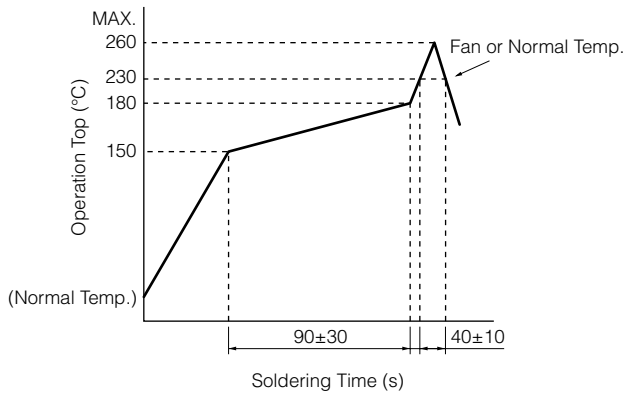

*Reflow temperature may vary by location even in the same reflow condition.
Please check the reflow temperature at terminals and at the top of a switch to make sure the both temperatures are within the specification.
If even one of them is out of the specifications, please adjust.

● Embossed Carrier Taping

Tape width=12.0 mm

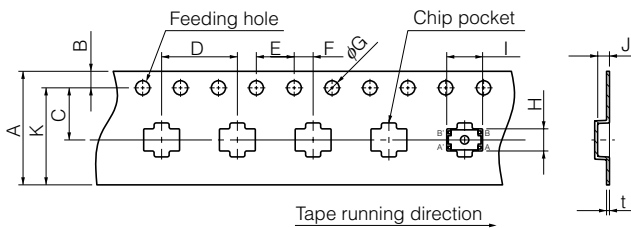

Taping condition : Lack of products in the middle of taping should be one MAX, but total quantity specified in the specifications should be secured.
Peeling off strength of top tape : It should be within 0.2N to 1.0N at 165 degree in peeling off angle.
Joint of carrier tape : One joint per one reel may exist.

Unit: mm

Part No.	Height	A	B	C	D	E	F	G	H	I	J	K	t
EVPAY	0.7	12.0±0.3	1.75±0.10	5.5±0.1	8.0±0.1	4.0±0.1	2.0±0.1	1.5±0.3	3.15±0.20	3.7±0.2	0.8±0.2	(10.25)	0.3±0.1

● Standard Reel Dimensions in mm (not to scale)

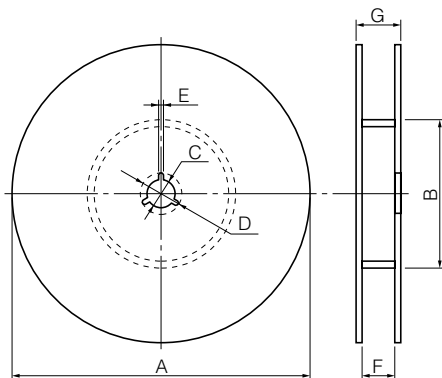

Item	A	B	C	D	E
Rate (mm)	φ380.0±2.0	φ80.0±1.0	φ13.0±0.5	φ21.0±1.0	2.0±0.5

Item	F	G
Rate (mm)	13.5±1.0	17.5±1.0