



The Future of Analog IC Technology®

EV8833-D-01B

1.5A Thermoelectric Cooler Controller Evaluation Demo Board

DESCRIPTION

The MP8833 is a monolithic thermoelectric cooler controller with built-in internal power MOSFETs. It achieves 1.5A continuous output current from a 2.7V-to-5.5V input voltage with TEC voltage range. The TEC voltage is linear controlled by an analog voltage.

The features such as TEC voltage/current limit, can be controlled on-the fly through a 3.4Mbps I²C serial interface. This brings minimum external components. Combined with a QFN package, the minimum solution size is obtained. Fully protection features includes internal soft start, over current/voltage protection and over temperature protection.

The MP8833 is ideal for TEC device application such as an optical laser diode, fiber communication network.

ELECTRICAL SPECIFICATION

Parameter	Symbol	Value	Units
Input Voltage	V _{IN}	2.7– 5.5	V
Output Current	I _{OUT}	1.5	A

FEATURES

- 1% 2.5V REF Accuracy
- Wide 2.7V-to-5.5V Operating Input Range
- Up to 1.5A TEC Current
- TEC Current Monitor
- 30mΩ and 30mΩ Internal PWM MOSFET Switches
- 30mΩ and 30mΩ Internal Linear MOSFET Switches
- Default 1MHz Switching Frequency
- External SYNC Function
- EN/SD for Power Sequencing
- Available in QFN (2mmx 3mm)Package

APPLICATIONS

- Optical laser diode module
- Fiber Communication network
- Require TEC device application

All MPS parts are lead-free, halogen-free, and adhere to the RoHS directive. For MPS green status, please visit the MPS website under Quality Assurance.

“MPS” and “The Future of Analog IC Technology” are registered trademarks of Monolithic Power Systems, Inc..

TYPICAL APPLICATION

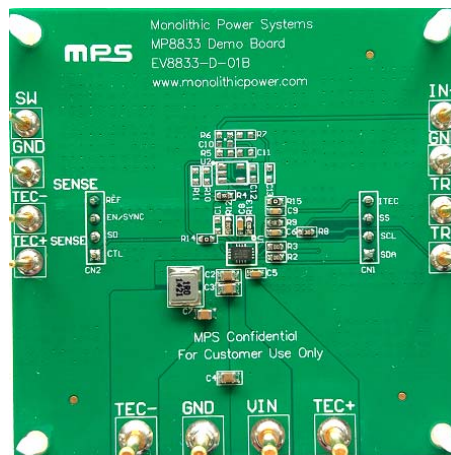

(L x W x H) 6.3cm x 6.3cm x 2.0cm

Board Number	MPS IC Number
EV8833-D-01B	MP8833GD

EVALUATION BOARD SCHEMATIC

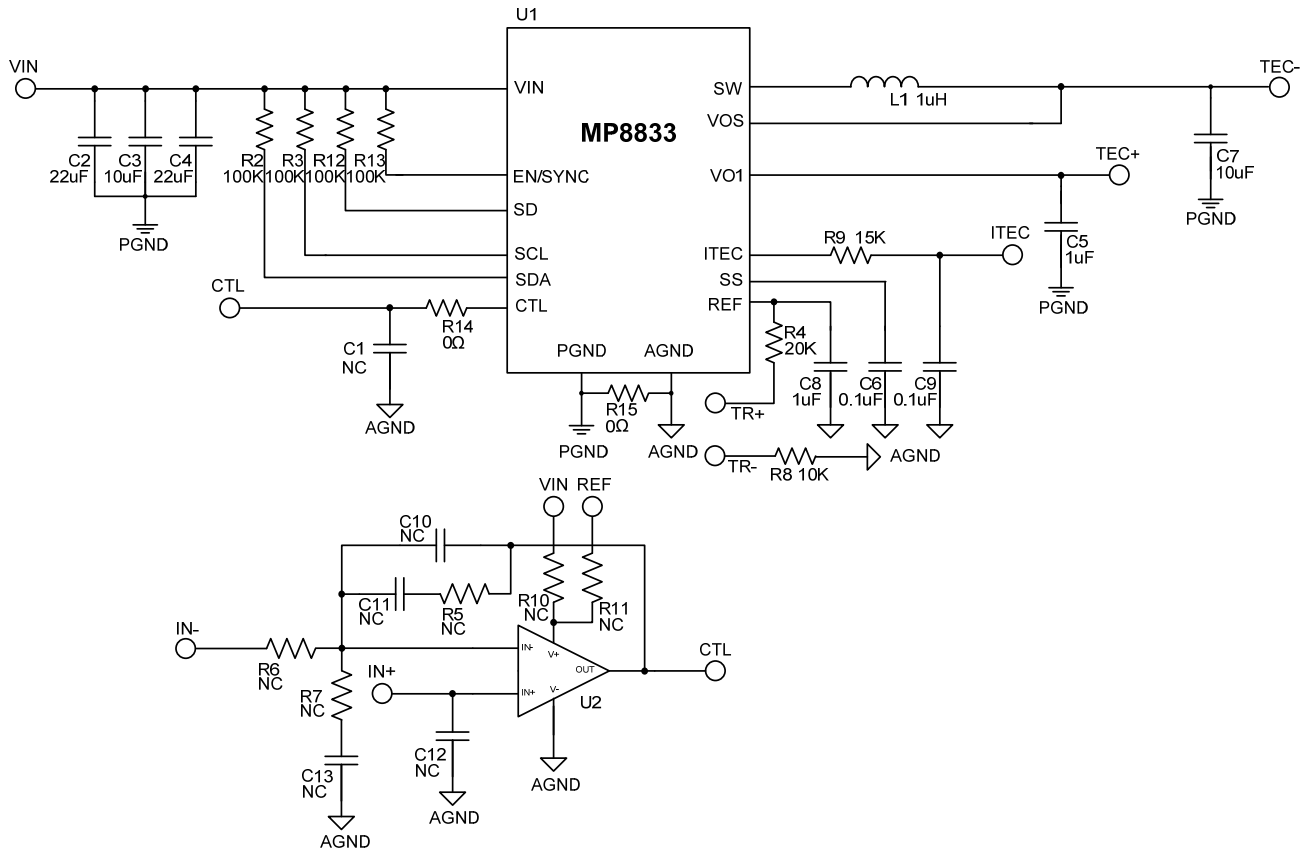

Figure1—Typical Application Circuit for MP8833GD

EV8833-D-01B BILL OF MATERIALS

Qty	RefDes	Value	Description	Package	Manufacturer	Manufacturer P/N
2	C6, C9	100nF	Ceramic Cap.,25V,X7R	0603	Murata	GRM188R71E104KA01D
2	C3, C7	10uF	Ceramic Cap.,25V,X7S	0805	Murata	GRM21BC71E106KE11L
2	C2, C4	22uF	Ceramic Cap.,25V,X5R	0805	Murata	GRM21BR61E226ME44L
2	C5, C8	1uF	Ceramic Cap.,25V,X7R	0603	Murata	GRM188R71E105KA12D
4	R2, R3, R12, R13	100k	Film Res,1%,0603,100K	0603	YAGEO	RC0603FR-07100KL
1	R9	15k	Film Res,1%,0603,15K	0603	YAGEO	RC0603FR-0715KL
2	R14, R15	0R	Film Res,1%,0603,0R	0603	YAGEO	RC0603FR-070RL
1	L1	1uH	Inductor,RDC=27mOhm,Isat=9 .0A	4020	WE	74437324010
1	R4	20k	Film Res,1%,0603,20K	0603	YAGEO	RC0603FR-0720KL
1	R8	10k	Film Res,1%,0603,10K	0603	YAGEO	RC0603FR-0710KL
1	U1	MP8833	1.5A Thermoelectric Cooler Controller	QFN-16	MPS	MP8833GD
0	C1, C10, C11, C12, C13	NC				
0	R5, R6, R7, R10, R11	NC				
0	U2	NC				

TYPICAL PERFORMANCE CHARACTERISTICS(continued)

$V_{IN} = 3.3V$, $L = 1\mu H$, $C_{OUT} = 10\mu F$, $T_A = +25^\circ C$, unless otherwise noted.

VIN Start-Up

$V_{IN} = 3.3V$, Cooling, $I_{OUT} = 0A$

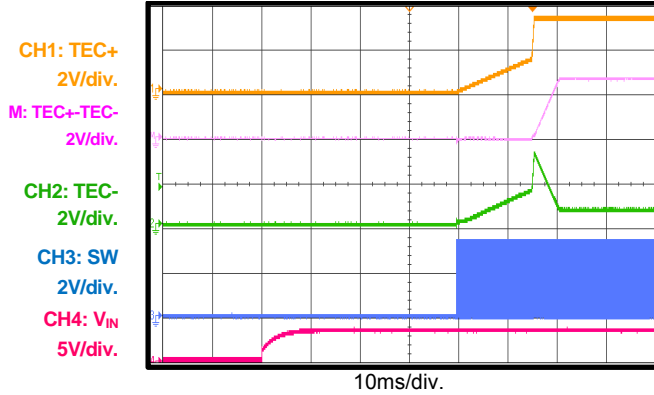

VIN Start-Up

$V_{IN} = 3.3V$, Heating, $I_{OUT} = 0A$

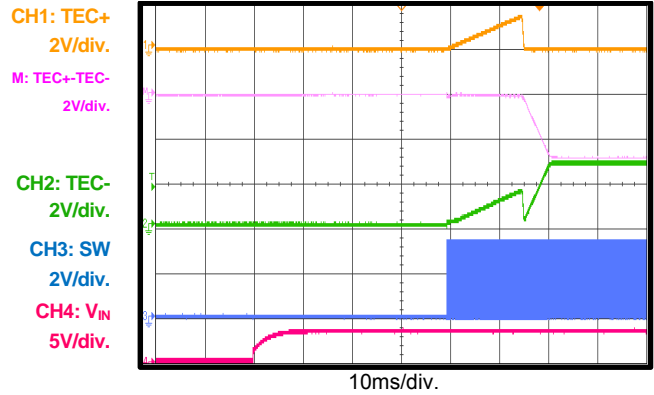

VIN Shutdown

$V_{IN} = 3.3V$, Cooling, $I_{OUT} = 0A$

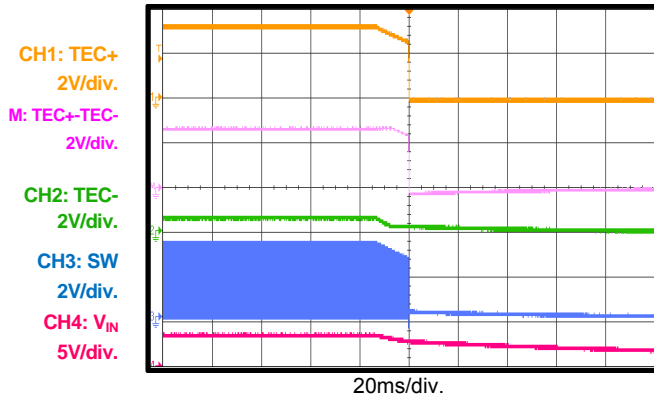

EN Start-Up

$V_{IN} = 3.3V$, Cooling, $I_{OUT} = 0A$

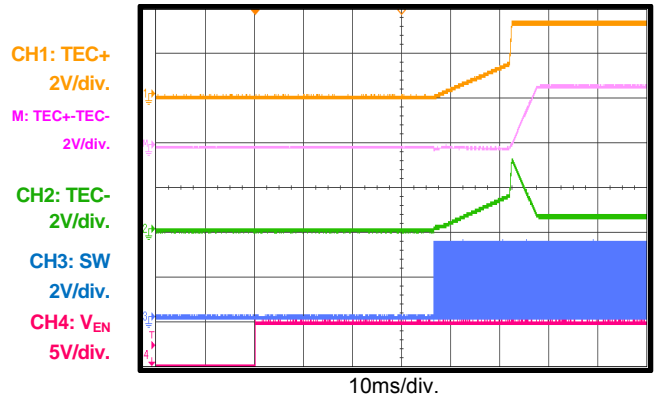

EN Shutdown

$V_{IN} = 3.3V$, Cooling, $I_{OUT} = 0A$

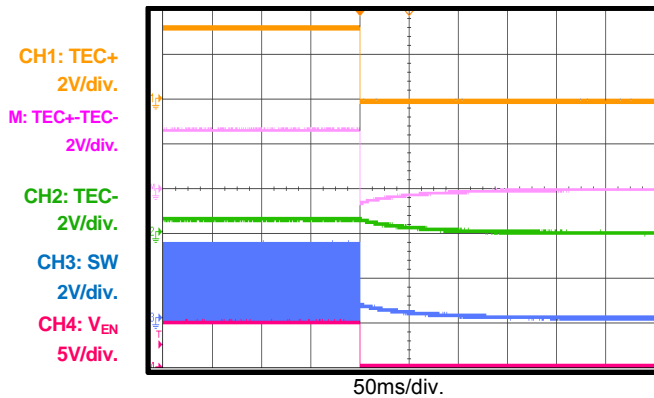

SD Start-Up

$V_{IN} = 3.3V$, Cooling, $I_{OUT} = 0A$

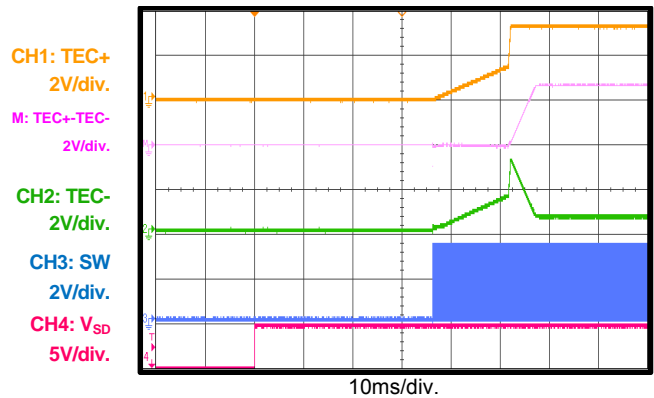

TYPICAL PERFORMANCE CHARACTERISTICS(continued)

$V_{IN} = 3.3V$, $L = 1\mu H$, $C_{OUT} = 10\mu F$, $T_A = +25^\circ C$, unless otherwise noted.

SD Shutdown

$V_{IN} = 3.3V$, Cooling, $I_{OUT} = 0A$

CH1: TEC+
2V/div.
M: TEC+ - TEC-
2V/div.
CH2: TEC-
2V/div.
CH3: SW
2V/div.
CH4: V_{SD}
5V/div.

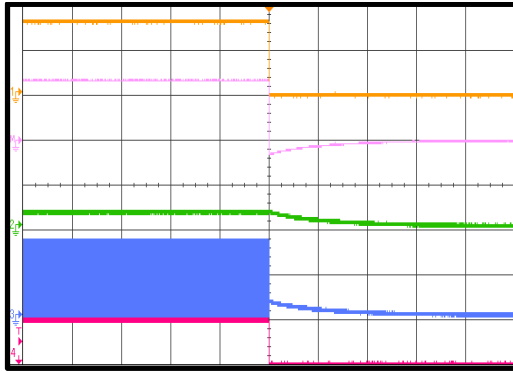

CTL Transient

$V_{IN} = 3.3V$, $I_{OUT} = 0A$

CH1: TEC+
2V/div.
M: TEC+ - TEC-
2V/div.
CH2: TEC-
2V/div.
CH3: SW
2V/div.
CH4: V_{CTL}
2V/div.

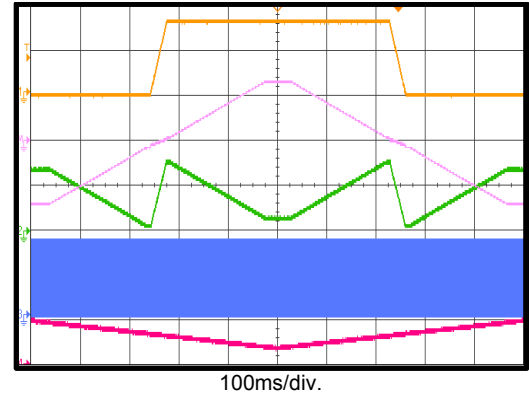

PRINTED CIRCUIT BOARD LAYOUT

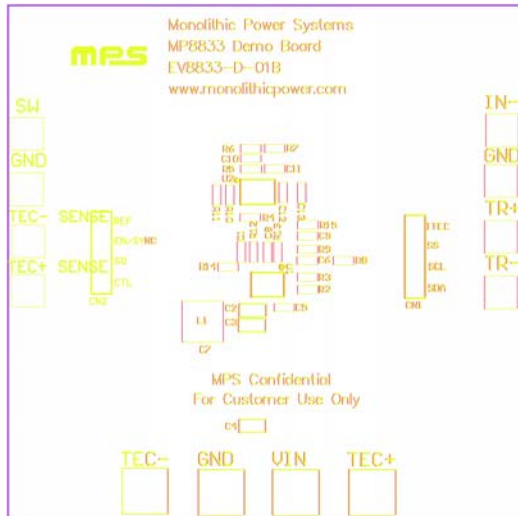

Figure 2—Top Silk Layer

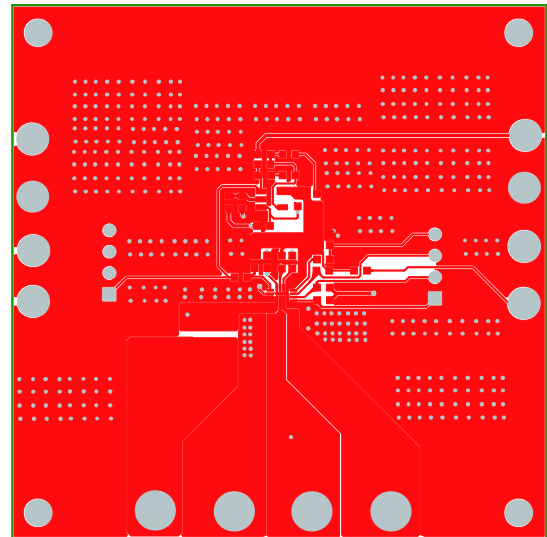

Figure 3—Top Layer

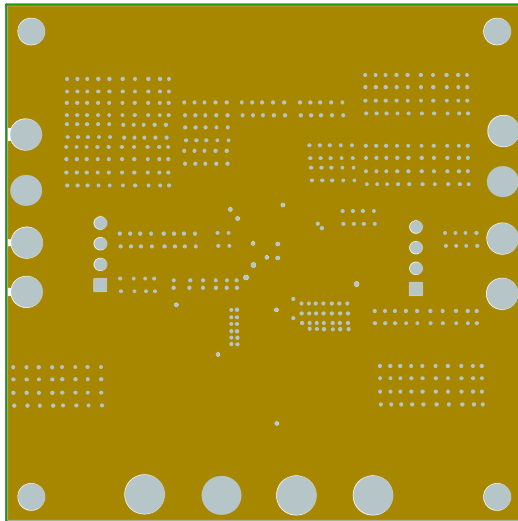

Figure 4—Middle Layer1

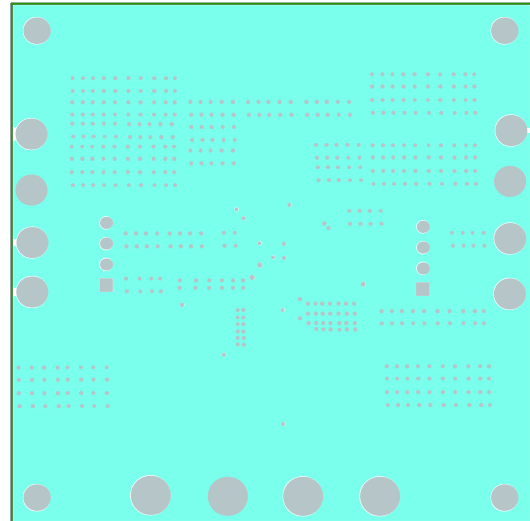

Figure 5—Middle Layer2

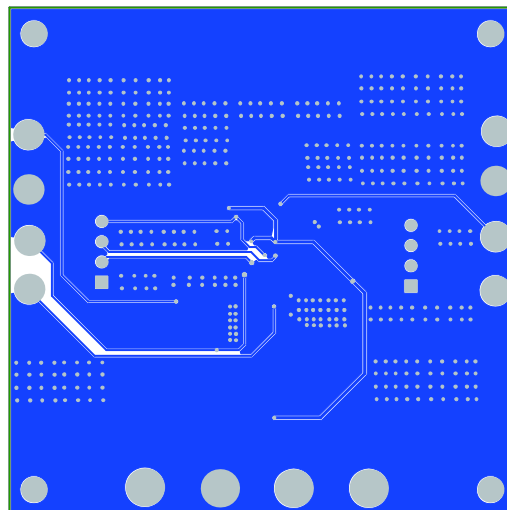

Figure 6—Bottom Layer

QUICK START GUIDE

EV8833-D-01B can combine with EV8833-Base-00A to get a close loop system, please refer EV8833-Base-Board datasheet and MP8833 datasheet for more details.

EV8833-D-01B can also work in open loop, please follow below steps to setup:

1. Connect a TEC or an R-load to the TEC+ and TEC- pins, respectively.
2. Preset the power supply output between 2.7V and 5.5V, and then turn off the power supply.
3. Connect the positive and negative terminals of the power supply output to the VIN and GND pins, respectively.
4. Turn the power supply on. The board will automatically start up.
5. Connect the CTL pin to a voltage within 0V to 5V to adjust the TEC voltage and direction.

NOTICE: The information in this document is subject to change without notice. Users should warrant and guarantee that third party Intellectual Property rights are not infringed upon when integrating MPS products into any application. MPS will not assume any legal responsibility for any said applications.