



SMD type

HF series

Features

- Meet for load dump surge test (JASO D 001-94) [$V_p=70\text{ V}$, $\tau=200\text{ ms}$, $R_i=0.8\ \Omega$]
- Meet for load dump surge test ISO7637-2 and ISO16750-2
- Suitable for requirements of automotive
- Compact size SMD
- Meet flow/reflow/iron soldering
- Strong against "Soldering heat shock" due to molded construction
- AEC-Q200 compliant
- RoHS compliant

Recommended applications

- Protection of body & accessory ECU about DC12 V automotive against load dump surge

■ As for handling precautions and minimum quantity / packing unit, please see related information

Explanation of part numbers

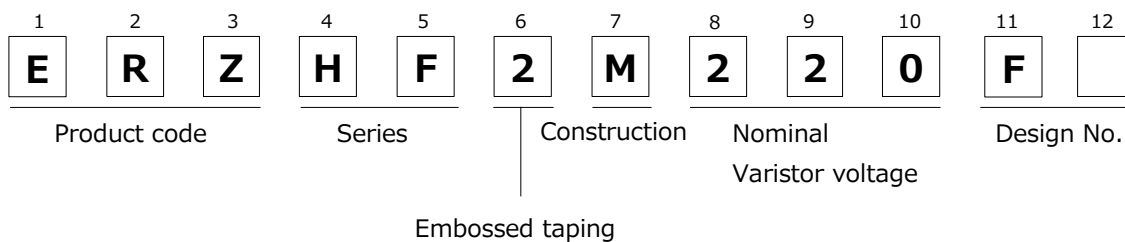

Construction

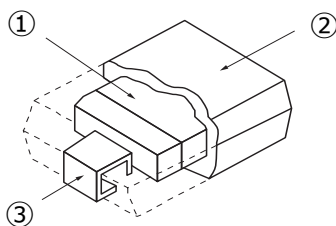

① Multilayer varistor	ZnO, others
② Mold resin	Epoxy (UL94 V-0 approved)
③ Lead terminal	ERZHF2M220F : Sn plated Cr-Cu alloy
	ERZHF2M220D / ERZHF2M270 : Sn plated Ni-Fe alloy

Dimensions in mm (not to scale)

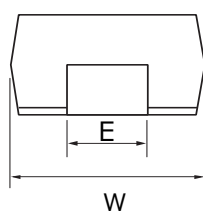
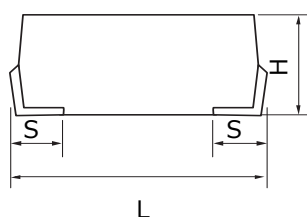

Unit : mm

Part No.	Dimensions				
	W	L	H	S	E
ERZHF2M220F	6.4±0.4	8.0±0.5	5.5±0.5	1.3±0.3	2.5±0.2
ERZHF2M220D			4.5±0.5		
ERZHF2M270					

Ratings and characteristics

- Operating temperature range : ERZHF2M220F -55 to 150 °C, ERZHF2M220D/ERZHF2M270 -40 to 125 °C
- Storage temperature range : ERZHF2M220F -55 to 150 °C, ERZHF2M220D/ERZHF2M270 -40 to 125 °C

Part No.	Varistor voltage	Maximum allowable voltage	Short time over-voltage	Clamping voltage	Load dump surge	Load dump surge energy ISO7637-2 TEST A
	V _{1mA} (V)	DC (V)	DC (V)	(V)at I _p 5(A)		(J)
ERZHF2M220F	20 to 23.2	16	24 5 min.	35 max.	JASO Category:A, A-1 70 V, 1time	50 max. 10 times
ERZHF2M220D				43 max.		—
ERZHF2M270	27±20 %					

Marking contents

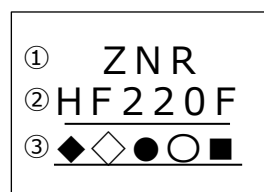

① Product name	ZNR Surge Absorbers	
② Abbreviation of P/N	HF220F (ERZHF2M220F), HF220 (ERZHF2M220D), HF270 (ERZHF2M270)	
③ Date code	◆ Yearly	2010:0, 2021:1, ..., 2019:9, 2020:A, 2021:B, ..., 2027:H, 2028:J, ..., 2032:N, 2033:P, 2034:R, ..., 2039:W (30 year cycle)
	◇ Monthly	Jan.: 1, Feb.: 2, ..., Aug.: 8, Sep.: 9, Oct.: O, Nov.: N, Dec.: D
	● Daily	1st to 9th: 1 to 9, 10th: A, 11th: B, ..., 17th: H, 18th: J, ..., 22nd: N, 23rd: P, 24th: R, ..., 30th: X, 31st: Y
	○ Suffix-1	A single digit of alphanumeric
	■ Suffix-2	A single digit of alphanumeric

Packaging methods

- Packing quantity

Style	Part No.	Quantity
Embossed taping	ERZHF2M220F	800 pcs / reel
	ERZHF2M220D	
	ERZHF2M270	1,000 pcs / reel

- Embossed taping

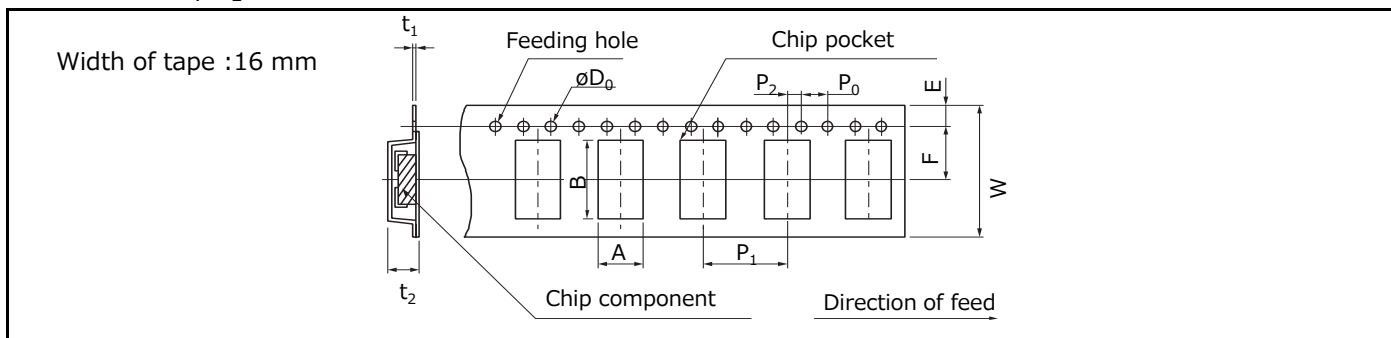

Unit : mm

Part No.	A	B	W	F	E	P ₁	P ₂	P ₀	øD ₀	t ₁	t ₂
ERZHF2M220F	7.5 max.	11.9 max.	16.0±0.3	7.5±0.1	1.75±0.10	12.0±0.1	2.0±0.1	4.0±0.1	1.5+0.1/0	0.8 max.	9.0 max.
ERZHF2M220D											8.0 max.
ERZHF2M270											8.0 max.

- Reel

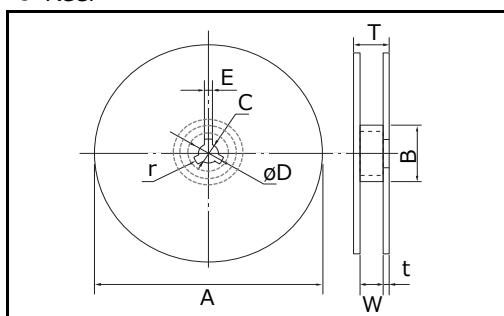

Unit : mm

Part No.	A	B	C	øD	E
ERZHF2M	382 max.	50 min.	13.0±0.5	21.0±0.8	2.0±0.5
	W	T	t	r	
	16.4+2.0/0	22.4 max.	2.5±0.5	1.0	

Performance characteristics

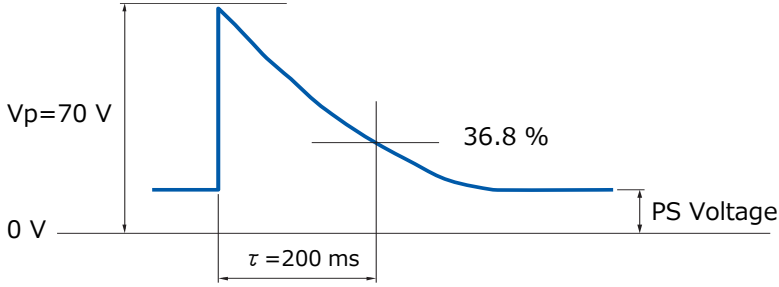
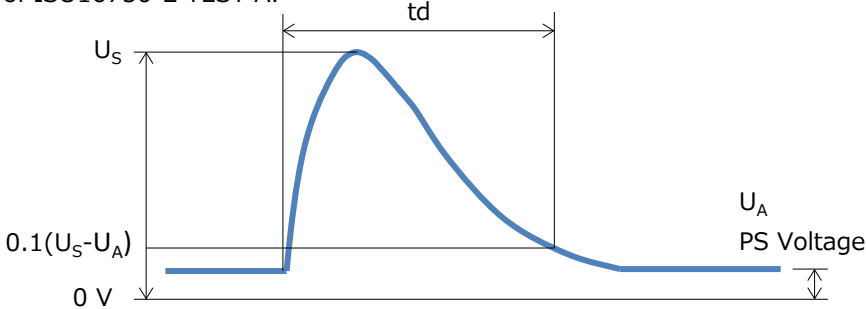
Characteristics	Test methods	Specifications
Standard test condition	Environmental conditions under which every measuring is done without doubt on the measuring results. Unless specially, specified, temperature, relative humidity are 5 °C to 35 °C, 45 to 85% RH respectively.	-
Maximum allowable voltage	The maximum DC voltage that can be applied continuously in the specified environmental temperature range.	To meet the specified value.
Short time over-voltage	The maximum DC Voltage that can be applied specified period without breakdown.	
Varistor voltage	Voltage between both terminals of ZNR measured when 1 mA of DC current is applied under standard conditions. It is called V1. Measuring the varistor voltage should be made promptly to avoid heat affection.	
Clamping voltage	The maximum voltage between two terminals with the specified impulse current (8/20 μs).	
Load dump surge	The test waveform of transient voltage which specified JASO Category A A-1 70 V without breakdown. 	No breakdown.
Load dump surge energy	Surge energy which can be applied at 10 times on the condition of ISO16750-2 TEST A. 	No breakdown.

※ Please Check Specification of the products about Mechanical & Environmental etc. requirements.

Recommendation land size

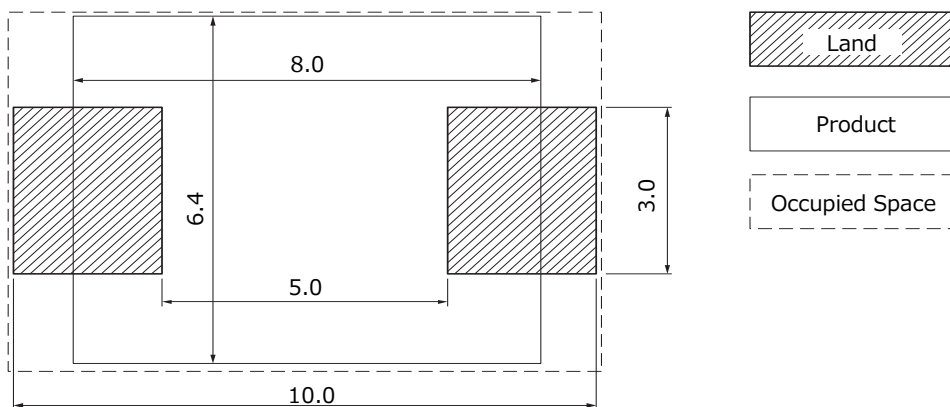

Unit : mm

Guidelines and precautions regarding the technical information and use of our products described in this online catalog.

- If you want to use our products described in this online catalog for applications requiring special qualities or reliability, or for applications where the failure or malfunction of the products may directly jeopardize human life or potentially cause personal injury (e.g. aircraft and aerospace equipment, traffic and transportation equipment, combustion equipment, medical equipment, accident prevention, anti-crime equipment, and/or safety equipment), it is necessary to verify whether the specifications of our products fit to such applications. Please ensure that you will ask and check with our inquiry desk as to whether the specifications of our products fit to such applications use before you use our products.
- The quality and performance of our products as described in this online catalog only apply to our products when used in isolation. Therefore, please ensure you evaluate and verify our products under the specific circumstances in which our products are assembled in your own products and in which our products will actually be used.
- If you use our products in equipment that requires a high degree of reliability, regardless of the application, it is recommended that you set up protection circuits and redundancy circuits in order to ensure safety of your equipment.
- The products and product specifications described in this online catalog are subject to change for improvement without prior notice. Therefore, please be sure to request and confirm the latest product specifications which explain the specifications of our products in detail, before you finalize the design of your applications, purchase, or use our products.
- The technical information in this online catalog provides examples of our products' typical operations and application circuits. We do not guarantee the non-infringement of third party's intellectual property rights and we do not grant any license, right, or interest in our intellectual property.
- If any of our products, product specifications and/or technical information in this online catalog is to be exported or provided to non-residents, the laws and regulations of the exporting country, especially with regard to security and export control, shall be observed.

<Regarding the Certificate of Compliance with the EU RoHS Directive/REACH Regulations>

- The switchover date for compliance with the RoHS Directive/REACH Regulations varies depending on the part number or series of our products.
- When you use the inventory of our products for which it is unclear whether those products are compliant with the RoHS Directive/REACH Regulation, please select "Sales Inquiry" in the website inquiry form and contact us.

We do not take any responsibility for the use of our products outside the scope of the specifications, descriptions, guidelines and precautions described in this online catalog.

Varistors (ZNR Surge Absorber) Type D, Series V

Varistors (ZNR Surge Absorber) Type SMD, Series HF, VF

Handling Precautions

Safety Precautions

In case that a Varistors (ZNR Surge Absorber) (hereafter referred to as the ZNR, or product name) is used, if an abnormality takes place because of peripheral conditions of the ZNR(material, environments, power source conditions, circuit conditions, etc. in equipment design), fire, electric shock, burn, or product failure may occur. The precautions for this product are described below, understand the content thoroughly before usage. For more questions, contact us.

If there's any uncertainty/doubt/products safety items, please contact us. When a dogma shall be occurred about safety for this products, be sure to inform us rapidly, operate your technical examination.

1. Precautions to be strictly observed

1.1 Confirmation of performance ratings

Use the ZNR within its rated range of performance such as the Max. allowable voltage, withstanding surge current, withstanding energy, impulse life(surge life), average pulse power, and operating temperature range. If used outside the range, the ZNR can be degrade and have element fracture, which may result in smoking and ignition.

1.2 To avoid accidents due to unexpected phenomena, take the following measures

- 1) In the event of fracture of the ZNR, its pieces may scatter ; hence, put the case or cover of the set product in place.
- 2) Do not install the ZNR near combustible substances(polyvinyl chloride wires, resin moldings, etc.).
If it is difficult to do, install a nonflammable cover.
- 3) Across-the-line use
When the ZNR is used across a line, put a current fuse in series with the ZNR(Refer to Item 2.1.1). (4) .
- 4) Use between line to ground
 - (1) If the case that the ZNR is used between a line to the ground, the short-circuit of the ZNR may not blow the current fuse because of grounding resistance, which may cause smoking and ignition of the ZNR's exterior resin.
As the measure against it, install an earth leakage breaker on the power supply side of the ZNR position. If no earth leakage breaker is installed, use a thermal fuse together with a current fuse in series. (Refer to Table 1.)
 - (2) If the case that the ZNR is used between a live part to metal case, an electric shock may develop at a shortcircuit of the ZNR ; hence, ground the metal case to the ground or keep it from the human body.

1.3 If ZNR is shorted out and happen smoke or ignition, please cut provided current to ZNR immediately.

2. Application notes

2.1 Pay attention to the following items to avoid the shortened life and failure of the ZNR

- 1) Circuit conditions
 - (1) Select a ZNR of which the maximum voltage including fluctuations in source voltage allows for the maximum permissible circuit voltage. (Refer to Table 1.)
 - (2) In cases that surges are intermittently applied at short intervals(for example, in case that the voltage of the noise simulator test is implemented etc.), do not let them exceed the ZNR's rated power.
 - (3) Select a ZNR recommended in Table 1.
<1> Across-the-line use
If possible, use a Part No. marked with * in case of voltage temporarily rises load unbalance of separately-wired loads, short between hot and neutral-line, open of neutral line in single-phase-three-wired system, and due to resonance at switching for a capacitive, inductive load.

<2> Used between line to ground

Use a different Part No. from "Across-the-line use" as table 1, because of raising voltage in case of "Line to Ground Fault".

Use a Part No. marked with ** in table 1, in case of the insulation resistance test(500 VDC) for equipment. When using a Part of the varistor voltage that the insulation efficiency examination can not be cleared, there is a case where the surge absorber can be done by removing it from the circuit depending on the circuit condition(Refer examination of Japan Domestic Safety Regulations).

Use a Part No. marked with *** in table 1, in case of the withstanding voltage test (1000 VAC or 1200 VAC) for equipment.

(4) Concerning current fuse

<1> We recommend selecting a ZNR and the rated current of a current fuse as follows.

Finally, please be sure that there is no danger if the ZNR mounted on the equipment breaks.

●Type D, Series V

Standard Part No.	ERZV05D□□□	ERZV07D□□□	ERZV09D□□□	ERZV10D□□□	ERZV14D□□□	ERZV20D□□□
Fuse rated current	3 A max.	5 A max.	7 A max.	7 A max.	10 A max.	10 A max.

◆ Fuses shall use rated voltages appropriate for circuits.

●Type SMD, Series VF

Standard Part No.	ERZVF□M□□□
Fuse rated current	5 A max.

◆ Fuses shall use rated voltages appropriate for circuits.

◆ Concerning HF series, please confirm adjusted to load dump surge and protection cooperation.

<2> The recommended fuse position is shown in table 1, "Example of ZNR application", however, if the load current of protected equipment is larger than that of the above recommended fuse rated current, install a current fuse at the position shown below.

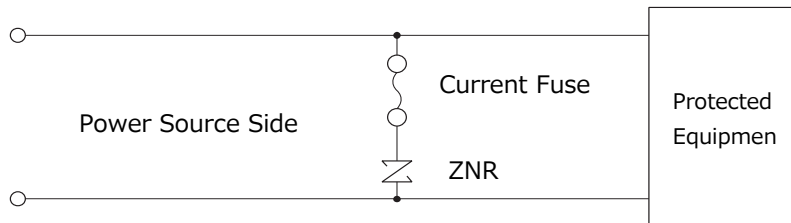

(5) Concerning thermal fuse

Set a thermal fuse to get high thermal

Table 1 Example of ZNR application

		Across-the-Line use	Use between Line to ground																																																													
Connections example	DC/AC Single-phase																																																															
	AC 3-phase																																																															
Example of varistor voltage	ZNR	<table border="1"> <thead> <tr> <th rowspan="2">Source voltage</th> <th colspan="2">Nominal varistor voltage</th> </tr> <tr> <th>Type D</th> <th>SMD Mold Type</th> </tr> </thead> <tbody> <tr> <td>AC 100 V</td> <td>201 to 361*</td> <td>201 to 361*</td> </tr> <tr> <td>AC 120 V</td> <td>241 to 431*</td> <td>241 to 431*</td> </tr> <tr> <td>AC 200 V</td> <td>471 to 621*</td> <td>471</td> </tr> <tr> <td>AC 220 V</td> <td>471 to 621*</td> <td>471</td> </tr> <tr> <td>AC 240 V</td> <td>511, 621*</td> <td>-</td> </tr> <tr> <td>AC 380 V</td> <td>821</td> <td>-</td> </tr> </tbody> </table>	Source voltage	Nominal varistor voltage		Type D	SMD Mold Type	AC 100 V	201 to 361*	201 to 361*	AC 120 V	241 to 431*	241 to 431*	AC 200 V	471 to 621*	471	AC 220 V	471 to 621*	471	AC 240 V	511, 621*	-	AC 380 V	821	-	<table border="1"> <thead> <tr> <th rowspan="2">Source voltage</th> <th colspan="2">Nominal varistor voltage</th> </tr> <tr> <th>Type D</th> <th>SMD Mold Type</th> </tr> </thead> <tbody> <tr> <td>AC 100 V</td> <td>471</td> <td>471</td> </tr> <tr> <td>AC 220 V</td> <td>511</td> <td>-</td> </tr> <tr> <td></td> <td>621*</td> <td>-</td> </tr> <tr> <td></td> <td>821 and more**</td> <td>-</td> </tr> <tr> <td></td> <td>182***</td> <td>-</td> </tr> <tr> <td>AC 230 V</td> <td>511</td> <td>-</td> </tr> <tr> <td>AC 240 V</td> <td>621*</td> <td>-</td> </tr> <tr> <td></td> <td>821 and more**</td> <td>-</td> </tr> <tr> <td></td> <td>182***</td> <td>-</td> </tr> <tr> <td>AC 380 V</td> <td>112**</td> <td>-</td> </tr> <tr> <td></td> <td>182***</td> <td>-</td> </tr> </tbody> </table>	Source voltage	Nominal varistor voltage		Type D	SMD Mold Type	AC 100 V	471	471	AC 220 V	511	-		621*	-		821 and more**	-		182***	-	AC 230 V	511	-	AC 240 V	621*	-		821 and more**	-		182***	-	AC 380 V	112**	-		182***	-
	Source voltage	Nominal varistor voltage																																																														
Type D		SMD Mold Type																																																														
AC 100 V	201 to 361*	201 to 361*																																																														
AC 120 V	241 to 431*	241 to 431*																																																														
AC 200 V	471 to 621*	471																																																														
AC 220 V	471 to 621*	471																																																														
AC 240 V	511, 621*	-																																																														
AC 380 V	821	-																																																														
Source voltage	Nominal varistor voltage																																																															
	Type D	SMD Mold Type																																																														
AC 100 V	471	471																																																														
AC 220 V	511	-																																																														
	621*	-																																																														
	821 and more**	-																																																														
	182***	-																																																														
AC 230 V	511	-																																																														
AC 240 V	621*	-																																																														
	821 and more**	-																																																														
	182***	-																																																														
AC 380 V	112**	-																																																														
	182***	-																																																														
		Note : Element size is selected by impulse Condition.																																																														

(6) On use for equipment

The catalog guarantees the quality as individual component.

Before you use the products, please make sure to check and evaluate the products in the circumstance where they are installed in your product.

2) Operating environments

- (1) The ZNR is designed to be used indoors. Do not use it exposed outdoors.
- (2) Do not use the ZNR in places exposed to temperatures beyond the operating temperature range, such as places exposed to sunlight and vicinities of heating equipment.
- (3) Do not use the ZNR in places exposed to high temperatures and high humidity, such as places exposed directly to rain, wind, dew condensation, and vapor.
- (4) Do not use the ZNR in dusty and salinity environment and atmospheres polluted by corrosive gases, in liquids such as water, oil, chemical, organic solvent.

3) Processing conditions

- (1) Do not wash the ZNR by such solvents(thinner, acetone, etc.) as its exterior resin deteriorates.
- (2) Do not apply a strong vibration or shock (by falling, etc.) to the ZNR, cracking to its exterior resin and element may occur.
- (3) When coating the ZNR with resin(including molding), do not use such resin.
- (4) Do not bend the ZNR type D lead wires at the position close to its ZNR type D exterior resin, or apply external force to the position.
- (5) When soldering the ZNR lead wires, follow the recommended conditions and do not melt the solder and insulating materials constituting the ZNR.

	Soldering Method	Recommended Condition	Attention Item
Type D	Flow soldering	260 °C, within 10 seconds.	Type D is not Reflow soldering object part.
SMD Type	Flow soldering	260 °C, within 10 seconds.	When the package density of the part is high pill out gas because the solderability sometimes becomes bad.
	Reflow soldering	Refer to Reflow soldering profile	When Land is too big compared with the size of the terminal surface of the part, be careful because the part sometimes upset when solder fuses.

- * 1 Soldering iron temperature should not exceed 400 °C and should not be applied for more than 5 seconds.
- * 2 Profile be careful because there is a margin of error in the way of measuring.
- * 3 The temperature depend on the size and the package density of the substrate. Therefore, confirm every kind of the substrate.

● Soldering temperature-time profile to recommend

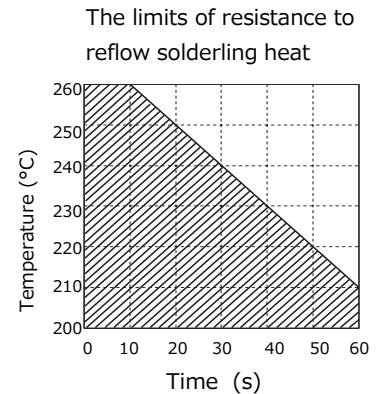
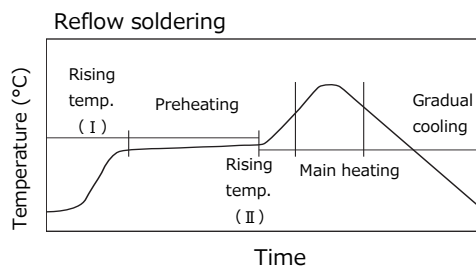
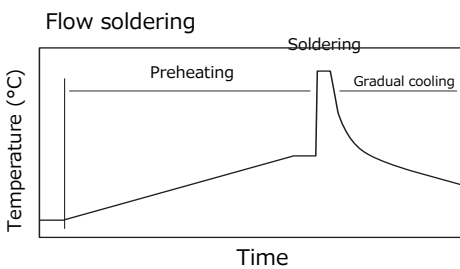

Preheating	The normal to 130 °C	max. 120 s
Soldering	max. 260 °C	max. 10 s
Gradual cooling	Gradual cooling	

Rising temperature I	The normal to preheating temperature	30 to 60 s
Preheating	150 °C to 180 °C	60 to 120 s
Rising temperature II	Preheating to 200 °C	2 to 6 °C / s
Main heating	(cf. The limit of resistance to reflow soldering heat)	
Gradual cooling	200 °C to 100 °C	1 to 4 °C / s

(Reflow soldering shall be within two times)

(6) Lead-wire terminal land-hole (only for Type D)

When designing lead-wire-terminal land-hole of circuit board, please check actual ZNR by reference specification about center value of lead-wire terminal pitch.

(7) Mounting (only for Type SMD)

In case of mounting ZNR on a Printed Circuit Board, be careful not to put excessive impact load, such as pressure from adsorption nozzle, and mechanical impact/stress of position-shifting or positioning. Also, we recommend you to fix a Printed Circuit Board to sheathing resin with an adhesive in case of position-shifting of ZNR when mounting.

4) Long-term storage

- (1) Do not store the ZNR under high temperature and high humidity. Store it indoor environment at a temperature up to 40 °C and at humidity below 75 %RH, and use it within two years. Before using the ZNR that has been stored for a long period(two years or longer), confirm the solderability.
- (2) Avoid atmospheres full of corrosive gases (hydrogen sulfide, sulfurous acid, chlorine, ammonia, etc.).
- (3) Avoid direct sunlight and dew condensation.

5) Rated Voltage for UL or other safety certifications

Our ZNR define " Max. Allowable Voltage" and "Rated Voltage " to keep leakage current specification and others. If you getting certificate of safety approval about your equipment with our ZNR, please follow our "Rated Voltage".

6) Dropped product

Do not drop this product on the floor. If this product is dropped, it can be damaged mechanically or electrically. Avoid using the dropped product.

3. Notices

- 3.1 Our ZNR was designed and manufactured for standard applications such as general electronics devices, office equipment, information and communications equipment, measuring instruments, household appliances and audio-video equipment. For applications in which special quality and reliability are required, or if the failure or malfunction of the products may directly jeopardize life or cause threat of personal injury (such as for aircraft and aerospace equipment, traffic and transport equipment, combustion equipment, medical equipment, accident prevention and anti-theft devices, and safety equipment), please be sure to consult with our sales representative in advance and to exchange product specifications which conform to such applications. applications in which special quality and reliability are required, or if the failure or malfunction of the products may.
- 3.2 Note that we do not take any responsibility for faults and abnormalities resulting from the use not in conformity with the contents of entries in the delivery specification.
- 3.3 There is a possibility that the ZNR will unexpectedly cause smoke or ignite because of an abnormal rise of the circuit voltage and invasion of excessive surge. To prevent that accident from spreading over the equipment and not to expand the damage, use multiplex protection such as the adoption of flame-retardant materials for housing parts and structural parts.

4. Applicable laws and regulations , others

- 4.1 This product not been manufactured with any ozone depleting chemical controlled under the Montreal Protocol.
- 4.2 This product comply with RoHS(Restriction of the use of certain Hazardous Substance in electrical and electronic equipment) (DIRECTIVE 2011/65/EU and (EU)2015/863).
- 4.3 All the materials used in this part are registered material under the Law Concerning the Examination and Regulation of Manufacture, etc. of Chemical Substance.
- 4.4 If you need the notice by letter of "A preliminary judgement on the Laws of Japan foreign exchange and Foreign Trade Control", be sure to let us know.
- 4.5 These products are not dangerous goods on the transportation as identified by UN(United nations) numbers or UN classification.

5. Others

- 5.1 As to the disposal of ZNR, check the method of disposal in each country or origin where the ZNR are incorporated in your products to be used.
- 5.2 The technical information in this specification provides example of our products' typical operations and application circuit. We do not guarantee the non-infringement of third party's intellectual property rights and we do not grant any license, right or interest in our intellectual property.

6. AEC-Q200 Compliant (Type SMD, Series HF)

The products are tested based on all or part of the test conditions and methods defined in AEC-Q200. Please consult with Panasonic for the details of the product specification and specific evaluation test results, etc., and please review and approve Panasonic's product specification before ordering.