

ELH, Aluminum Electrolytic, 22,000 uF, 20%, 35 VDC, -40/+85°C

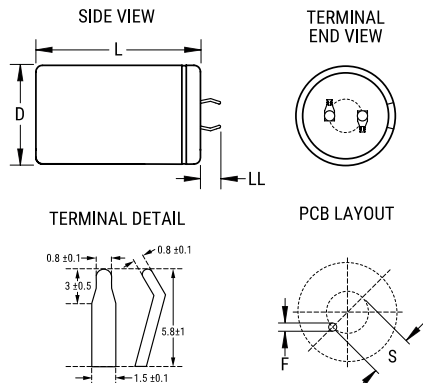

Dimensions

D	30mm +1mm
L	50mm +2mm
S	10mm +/-0.5mm
LL	5.8mm +/-1mm
F	1.5mm +/-0.1mm

Packaging Specifications

Packaging:	Bulk, Bag
Packaging Quantity:	200

General Information

Series:	ELH
Dielectric:	Aluminum Electrolytic
Description:	Snap-In, Aluminum Electrolytic
RoHS:	Yes
Lead:	2 Pin
AEC-Q200:	No

Specifications

Capacitance:	22,000 uF
Capacitance Tolerance:	20%
Voltage DC:	35 VDC, 63 VDC (Surge)
Temperature Range:	-40/+85°C
Rated Temperature:	85°C
Life:	2000 Hrs
Dissipation Factor:	35% 120Hz 20C
Ripple Current:	6000 mAmps (120Hz)
Leakage Current:	3000 uA (5min 20°C)