

ELG, Aluminum Electrolytic, 4,700 uF, 20%, 50 VDC, -40/+105°C

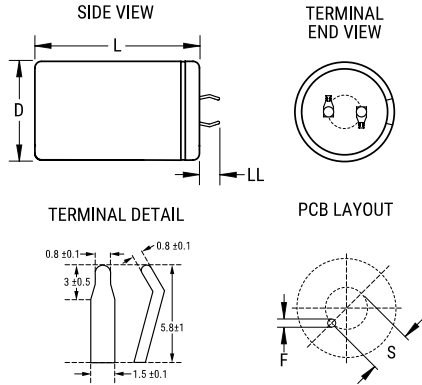

**Dimensions**

<b>D</b>	30mm +1mm
<b>L</b>	30mm +2mm
<b>S</b>	10mm +/-0.5mm
<b>LL</b>	5.8mm +/-1mm
<b>F</b>	1.5mm +/-0.1mm

**Packaging Specifications**

<b>Packaging:</b>	Bulk, Bag
<b>Packaging Quantity:</b>	200

**General Information**

<b>Series:</b>	ELG
<b>Dielectric:</b>	Aluminum Electrolytic
<b>Description:</b>	Snap-In, Aluminum Electrolytic
<b>RoHS:</b>	Yes
<b>Lead:</b>	2 Pin
<b>AEC-Q200:</b>	No

**Specifications**

<b>Capacitance:</b>	4,700 uF
<b>Capacitance Tolerance:</b>	20%
<b>Voltage DC:</b>	50 VDC, 63 VDC (Surge)
<b>Temperature Range:</b>	-40/+105°C
<b>Rated Temperature:</b>	105°C
<b>Life:</b>	2000 Hrs
<b>Dissipation Factor:</b>	30% 120Hz 20C
<b>Ripple Current:</b>	2450 mAmps (120Hz)
<b>Leakage Current:</b>	3000 uA (5min 20°C)
<b>Impedance Ratio at -25C:</b>	2
<b>Impedance Ratio at -40C:</b>	6