

ELG, Aluminum Electrolytic, 220 uF, 20%, 200 VDC, -25/+105°C

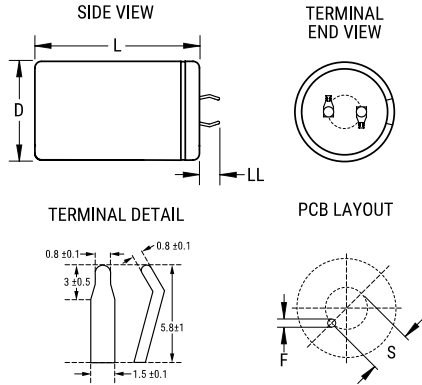

Dimensions

D	25mm +1mm
L	20mm +2mm
S	10mm +/-0.5mm
LL	5.8mm +/-1mm
F	1.5mm +/-0.1mm

Packaging Specifications

Packaging:	Bulk, Bag
Packaging Quantity:	200

General Information

Series:	ELG
Dielectric:	Aluminum Electrolytic
Description:	Snap-In, Aluminum Electrolytic
RoHS:	Yes
Lead:	2 Pin
AEC-Q200:	No

Specifications

Capacitance:	220 uF
Capacitance Tolerance:	20%
Voltage DC:	200 VDC, 250 VDC (Surge)
Temperature Range:	-25/+105°C
Rated Temperature:	105°C
Life:	2000 Hrs
Dissipation Factor:	15% 120Hz 20C
Resistance:	320 mOhms (20kHz)
Ripple Current:	800 mAmps (120Hz)
Leakage Current:	1300 uA (5min 20°C)
Impedance Ratio at -25C:	4