



OMRON ELECTRONICS EE-SY190

See full Datasheet below...

onlinecomponents.com
THE ONLINE DISTRIBUTOR OF ELECTRONIC COMPONENTS

BUY NOW

 **MASTER**TM
ELECTRONICS

BUY NOW

masterelectronics.com & onlinecomponents.com
are **authorized** e-commerce distributors
of electronic components.

■ Dimensions

Note: All units are in millimeters unless otherwise indicated.

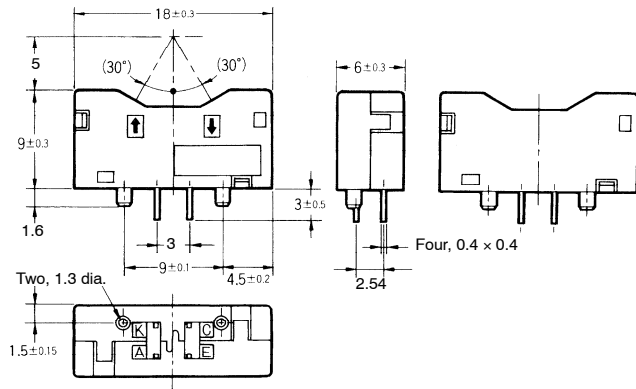

Internal Circuit

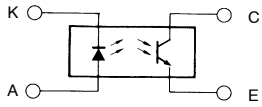

Unless otherwise specified, the tolerances are as shown below.

Dimensions	Tolerance
3 mm max.	±0.3
3 < mm ≤ 6	±0.375
6 < mm ≤ 10	±0.45
10 < mm ≤ 18	±0.55
18 < mm ≤ 30	±0.65

Terminal No.	Name
A	Anode
K	Cathode
C	Collector
E	Emitter

■ Features

- High-precision optical technology ensures excellent limited sensing range and sensing position characteristics.
- Ideal for paper/OHP detection in OA/CP markets.
- Compact package (length 18mm x width 6mm x height 9 mm).

■ Absolute Maximum Ratings (Ta = 25°C)

Item	Symbol	Rated value
Emitter	Forward current	I _F 50 mA (See Note 1.)
	Pulse forward current	I _{FP} 1 A (See Note 2.)
	Reverse voltage	V _R 4 V
Receiver	Collector-emitter voltage	V _{CEO} 30 V
	Emitter-collector voltage	V _{ECO} ---
	Collector current	I _C 20 mA
	Collector dissipation	P _C 100 mW (See Note 1.)
Ambient temperature	Operating	Topr -25°C to 85°C
	Storage	Tstg -40°C to 100°C
	Soldering	Tsol 260°C (10 secs max.)

- Note: 1. Refer to the Temperature Characteristics curves contained within the Engineering Data section if temperature exceeds 25°C.
 2. The pulse width is 10 μs maximum with a frequency of 100 Hz.

■ Ordering Information

Description	Part number
Micro-displacement sensor	EE-SY190

■ Electrical and Optical Characteristics (Ta = 25°C)

Item	Symbol	Value	Condition
Emitter	Forward voltage	V _F 1.2 V typ., 1.5 V max.	I _F = 30 mA
	Reverse current	I _R 10 μA max.	V _R = 4 V
	Peak emission wavelength	λ _{P(L)} 940 nm typ.	I _F = 30 mA
Receiver	Light current (See Note)	I _L 50 μA min., 180 μA typ., 600 μA max.	I _F = 20 mA, V _{CE} = 5 V White paper with a reflection factor of 90%, d = 4.5 mm (See Note 1.)
	Dark current	I _D 2 nA typ., 100 nA max.	V _{CE} = 5 V, 0 lx
	Leakage current	I _{LEAK} 1 μA max.	I _F = 20 mA, V _{CE} = 5 V without object
	Peak spectral sensitivity wavelength	λ _{P(P)} 850 nm typ.	V _{CE} = 5 V
Rising time	tr	30 μs typ.	V _{CC} = 5 V, R _L = 1 kΩ, I _L = 200 μA
Falling time	tf	30 μs typ.	V _{CC} = 5 V, R _L = 1 kΩ, I _L = 200 μA

Note: The letter "d" indicates the distance between the top surface of the sensor and the sensing object.

Engineering Data

Forward Current vs. Collector Dissipation Temperature Rating

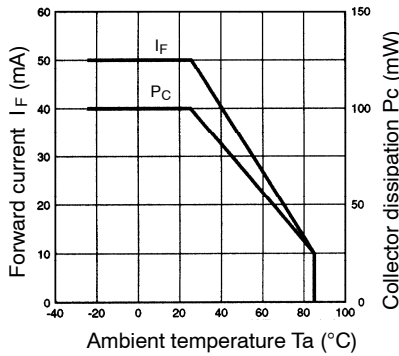

Relative Light Current vs. Ambient Temperature Characteristics (Typical)

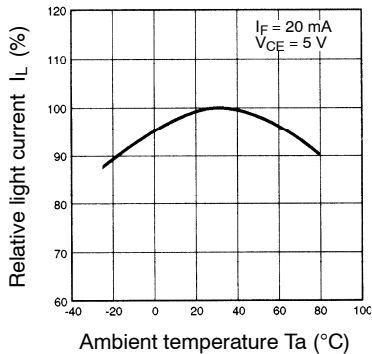

Sensing Distance Characteristics (Typical)

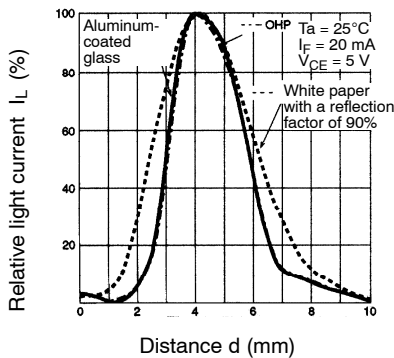

Sensing Angle Characteristics (Typical)

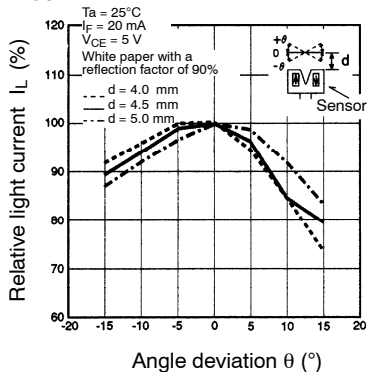

Light Current vs. Forward Current Characteristics (Typical)

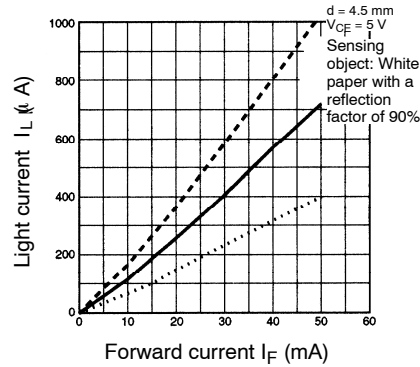

Dark Current vs. Ambient Temperature Characteristics (Typical)

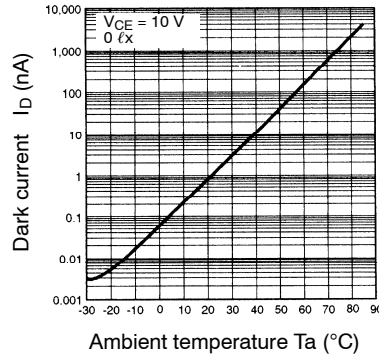

Sensing Position Characteristics X Direction (Typical)

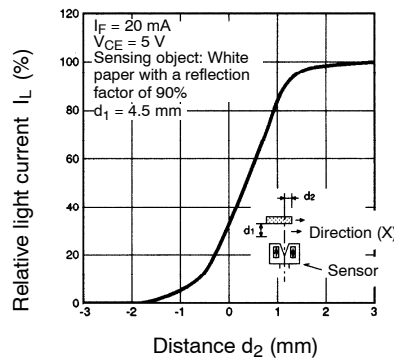

Sensing Angle Characteristics (Typical)

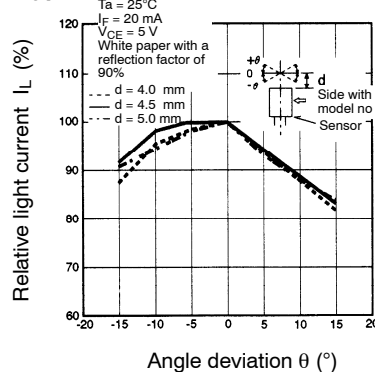

Light Current vs. Collector-Emitter Voltage Characteristics (Typical)

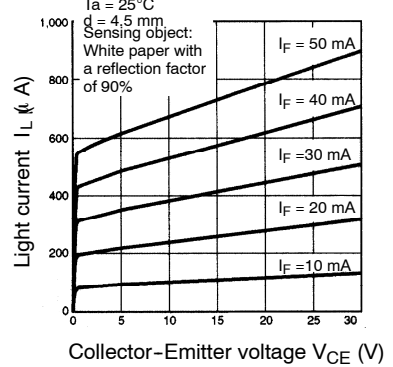

Response Time vs. Load Resistance Characteristics (Typical)

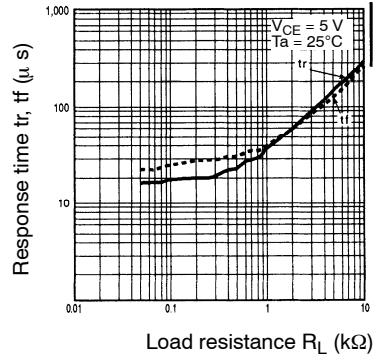

Sensing Position Characteristics Y Direction (Typical)

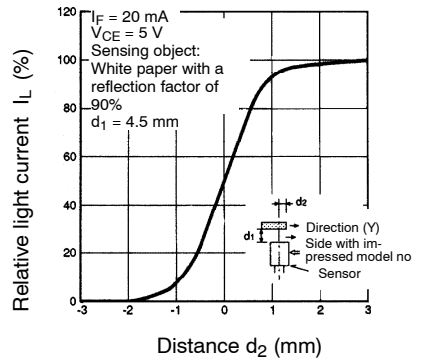

Response Time Measurement Circuit

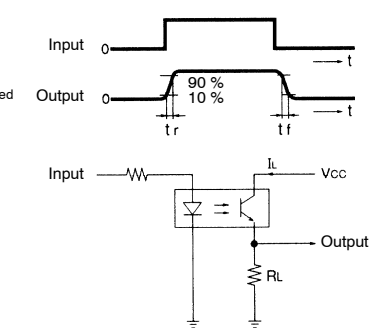

NOTE: DIMENSIONS SHOWN ARE IN MILLIMETERS. To convert millimeters to inches divide by 25.4.

OMRON[®]

OMRON ELECTRONICS LLC

One East Commerce Drive
Schaumburg, IL 60173

847-882-2288

OMRON CANADA, INC.

885 Milner Avenue
Toronto, Ontario M1B 5V8

416-286-6465

OMRON ON-LINE

Global – <http://www.omron.com>
USA – <http://www.omron.com/oei>
Canada – <http://www.omron.com/oci>