

Metallized Polypropylene Film Capacitor

Type : **ECWH(V)**

Designed for high frequency and pluse applications.

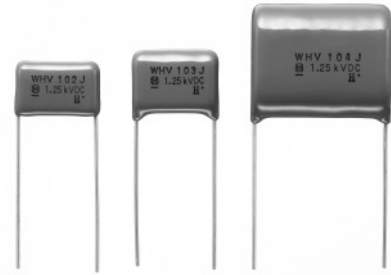

■Features

- Low-loss and inherent temperature rise
- Excellent electrical characteristics
- Flame-retardant epoxy resin coating
- RoHS directive compliant

■Recommended Applications

- TV, Monitors, Electronic ballast

■Explanation of Part Numbers

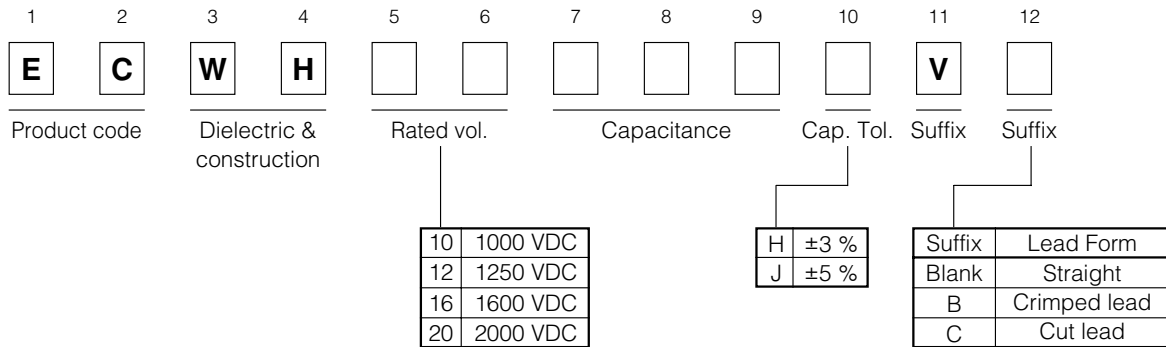

Metallized Film

●Explanation of Part Number for Odd Size Taping

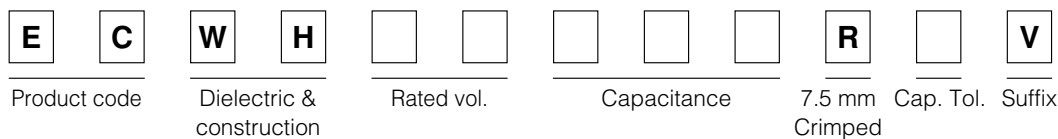

■Specifications

| | | |
|--|---|-----------------------|
| Category temp. range (Including temperature-rise on unit surface) | -40 °C to +105 °C | |
| Rated voltage | 1000 VDC, 1250 VDC (1000 Vp-p), 1600 VDC (1200 Vp-p), 2000 VDC (1500 Vp-p) (Derating of rated voltage by 1.25 %/°C at more than 85 °C) | |
| Capacitance range | 1000 VDC | 0.0075 µF to 0.10 µF |
| | 1250 VDC | 0.0036 µF to 0.10 µF |
| | 1600 VDC | 0.0013 µF to 0.056 µF |
| | 2000 VDC | 0.0010 µF to 0.015 µF |
| Capacitance tolerance | ±3 % (H), ±5 % (J) | |
| Dissipation factor (tanδ) | tanδ ≤ 0.1 % (20 °C, 1 kHz), tanδ ≤ 0.2 % (20 °C, 10 kHz) | |
| Withstand voltage | Between terminals: Rated volt. (VDC) × 150 % 60 s Between terminals to enclosure: 1500 VAC 60 s | |
| Insulation resistance (IR) | IR ≥ 30000 MΩ (20 °C, 500 VDC, 60 s) | |

* In case of applying voltage in alternating current (50 Hz or 60 Hz sine wave) to a capacitor with DC rated voltage, please refer to the page of “Permissible voltage (R.M.S) in alternating current corresponding to DC rated voltage”.

Design, Specifications are subject to change without notice. Ask factory for technical specifications before purchase and/or use. Whenever a doubt about safety arises from this product, please inform us immediately for technical consultation without fail.

■Dimensions in mm (not to scale)

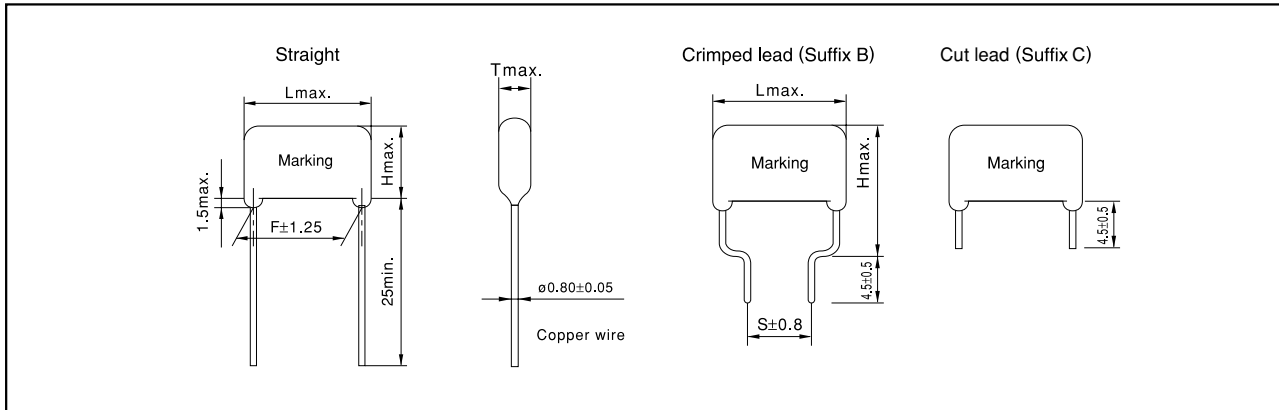

■Packaging Specifications for Bulk Package

Packing quantity : 100 pcs./bag

■Taping Specifications for Automatic Insertion

● Taping style

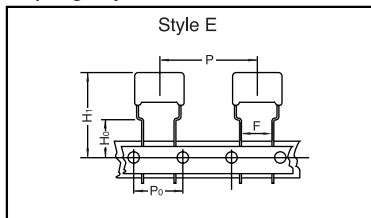

*Refer to the page of taping specifications.

●Packaging Specifications

| Type | Rated volt. | Cap. range (μF) | Taping style | | | | | Packing | suffix | |
|---------|-------------|-----------------|--------------|----|---|---|---|---------|--------|--------|
| | | | AD | AS | B | C | D | | | E |
| ECWH(V) | 1000 VDC | 0.0075 to 0.10 | | | | | | ○ | Ammo | R() V |
| | 1250 VDC | 0.0036 to 0.051 | | | | | | ○ | Ammo | R() V |
| | 1600 VDC | 0.0013 to 0.020 | | | | | | ○ | Ammo | R() V |
| | 2000 VDC | 0.0010 to 0.015 | | | | | | ○ | Ammo | R() V |

●Lead Spacing

| Style | Lead Spacing |
|-------|--------------|
| E | 7.5 mm |

*See the column "Rating, Dimensions & Quantity Box" for packing quantity.

■ Rating & Dimensions

● Rated voltage : 1000 VDC. Capacitance tolerance : ±3 % (H), ±5 % (J)

| Part No. | Cap. (μF) | Dimensions (mm) | | | | | | | Min. order Q'ty | | |
|----------------|--------------|------------------|------------------|------------------|--------------|----------|--------------|------|------------------|------|--|
| | | L _{max} | T _{max} | H _{max} | | F | S | ød | Taping 7.5 mm | Bulk | |
| | | | | Straight | Crimped lead | Straight | Crimped lead | | | | |
| ECWH10752□V() | 0.0075 | 18.0 | 6.0 | 12.5 | 17.5 | 15.0 | 10.0 | 0.80 | 500 | | |
| ECWH10822□V() | 0.0082 | 18.0 | 6.0 | 12.5 | 17.5 | 15.0 | 10.0 | 0.80 | | | |
| ECWH10912□V() | 0.0091 | 18.0 | 6.0 | 13.0 | 18.0 | 15.0 | 10.0 | 0.80 | | | |
| ECWH10103□V() | 0.010 | 18.0 | 6.5 | 13.0 | 18.0 | 15.0 | 10.0 | 0.80 | | | |
| ECWH10113□V() | 0.011 | 18.0 | 6.5 | 13.5 | 18.5 | 15.0 | 10.0 | 0.80 | | | |
| ECWH10123□V() | 0.012 | 18.0 | 6.5 | 13.5 | 18.5 | 15.0 | 10.0 | 0.80 | | | |
| ECWH10133□V() | 0.013 | 18.0 | 7.0 | 13.5 | 18.5 | 15.0 | 10.0 | 0.80 | | | |
| ECWH10153□V() | 0.015 | 18.0 | 7.0 | 14.0 | 19.0 | 15.0 | 10.0 | 0.80 | | | |
| ECWH10163□V() | 0.016 | 18.0 | 7.5 | 14.0 | 19.0 | 15.0 | 10.0 | 0.80 | | | |
| ECWH10183□V() | 0.018 | 18.0 | 7.5 | 14.5 | 19.5 | 15.0 | 10.0 | 0.80 | | | |
| ECWH10203□V() | 0.020 | 18.0 | 8.0 | 15.0 | 20.0 | 15.0 | 10.0 | 0.80 | 400 | | |
| ECWH10223□V() | 0.022 | 18.0 | 8.5 | 15.0 | 20.0 | 15.0 | 10.0 | 0.80 | | | |
| ECWH10243□V() | 0.024 | 18.0 | 8.5 | 15.5 | 20.5 | 15.0 | 10.0 | 0.80 | | | |
| ECWH10273□V() | 0.027 | 18.0 | 9.0 | 16.0 | 21.0 | 15.0 | 10.0 | 0.80 | 300 | 500 | |
| ECWH10303□V() | 0.030 | 18.0 | 9.5 | 16.5 | 21.5 | 15.0 | 10.0 | 0.80 | | | |
| ECWH10333□V() | 0.033 | 23.0 | 7.5 | 16.0 | 21.0 | 20.0 | 15.0 | 0.80 | 400 | | |
| ECWH10363□V() | 0.036 | 23.0 | 7.5 | 16.0 | 21.0 | 20.0 | 15.0 | 0.80 | | | |
| ECWH10393□V() | 0.039 | 23.0 | 8.0 | 16.5 | 21.5 | 20.0 | 15.0 | 0.80 | | | |
| ECWH10433□V() | 0.043 | 23.0 | 8.5 | 16.5 | 21.5 | 20.0 | 15.0 | 0.80 | | | |
| ECWH10473□V() | 0.047 | 23.0 | 8.5 | 17.0 | 22.0 | 20.0 | 15.0 | 0.80 | 300 | | |
| ECWH10513□V() | 0.051 | 23.0 | 9.0 | 17.5 | 22.5 | 20.0 | 15.0 | 0.80 | | | |
| ECWH10563□V() | 0.056 | 23.0 | 9.5 | 17.5 | 22.5 | 20.0 | 15.0 | 0.80 | | | |
| ECWH10623□V() | 0.062 | 23.0 | 9.5 | 18.0 | 23.0 | 20.0 | 15.0 | 0.80 | | | |
| ECWH10683□V() | 0.068 | 23.0 | 10.0 | 19.0 | 24.0 | 20.0 | 15.0 | 0.80 | | | |
| ECWH10753□V() | 0.075 | 23.0 | 10.5 | 19.5 | 24.5 | 20.0 | 15.0 | 0.80 | | | |
| ECWH10823□V() | 0.082 | 23.0 | 11.0 | 20.0 | 25.0 | 20.0 | 15.0 | 0.80 | | | |
| ECWH10913□V() | 0.091 | 23.0 | 11.5 | 20.5 | 25.5 | 20.0 | 15.0 | 0.80 | | | |
| ECWH10104□V() | 0.10 | 23.0 | 12.0 | 21.0 | 26.0 | 20.0 | 15.0 | 0.80 | | | |

Suffix for lead crimped
 Cap. tol. code

Metallized Film

■ Rating & Dimensions

● Rated voltage : 1250 VDC Capacitance tolerance : $\pm 3\%$ (H), $\pm 5\%$ (J)

| Part No. | Cap. (μ F) | Dimensions (mm) | | | | | | | Min. order Q'ty | | |
|----------------|--------------------|------------------|------------------|------------------|--------------|----------|--------------|--------------|-----------------|------------------|------|
| | | L _{max} | T _{max} | H _{max} | | F | | S | ϕ d | Taping 7.5 mm | Bulk |
| | | | | Straight | Crimped lead | Straight | Crimped lead | Crimped lead | | | |
| ECWH12362□V() | 0.0036 | 18.0 | 6.0 | 12.5 | 17.5 | 15.0 | 10.0 | 0.80 | 500 | | |
| ECWH12392□V() | 0.0039 | 18.0 | 6.0 | 12.5 | 17.5 | 15.0 | 10.0 | 0.80 | | | |
| ECWH12432□V() | 0.0043 | 18.0 | 6.0 | 13.0 | 18.0 | 15.0 | 10.0 | 0.80 | | | |
| ECWH12472□V() | 0.0047 | 18.0 | 6.0 | 13.0 | 18.0 | 15.0 | 10.0 | 0.80 | | | |
| ECWH12512□V() | 0.0051 | 18.0 | 6.5 | 13.0 | 18.0 | 15.0 | 10.0 | 0.80 | | | |
| ECWH12562□V() | 0.0056 | 18.0 | 6.5 | 13.5 | 18.5 | 15.0 | 10.0 | 0.80 | | | |
| ECWH12622□V() | 0.0062 | 18.0 | 6.5 | 13.5 | 18.5 | 15.0 | 10.0 | 0.80 | | | |
| ECWH12682□V() | 0.0068 | 18.0 | 7.0 | 13.5 | 18.5 | 15.0 | 10.0 | 0.80 | | | |
| ECWH12752□V() | 0.0075 | 18.0 | 7.0 | 14.0 | 19.0 | 15.0 | 10.0 | 0.80 | | | |
| ECWH12822□V() | 0.0082 | 18.0 | 7.5 | 14.0 | 19.0 | 15.0 | 10.0 | 0.80 | | | |
| ECWH12912□V() | 0.0091 | 18.0 | 7.5 | 14.5 | 19.5 | 15.0 | 10.0 | 0.80 | | | |
| ECWH12103□V() | 0.010 | 18.0 | 8.0 | 15.0 | 20.0 | 15.0 | 10.0 | 0.80 | 400 | | |
| ECWH12113□V() | 0.011 | 18.0 | 8.5 | 15.0 | 20.0 | 15.0 | 10.0 | 0.80 | | | |
| ECWH12123□V() | 0.012 | 18.0 | 8.5 | 15.5 | 20.5 | 15.0 | 10.0 | 0.80 | | | |
| ECWH12133□V() | 0.013 | 18.0 | 9.0 | 15.5 | 20.5 | 15.0 | 10.0 | 0.80 | | | |
| ECWH12153□V() | 0.015 | 18.0 | 9.5 | 16.0 | 21.0 | 15.0 | 10.0 | 0.80 | 500 | 500 | |
| ECWH12163□V() | 0.016 | 23.0 | 7.5 | 16.0 | 21.0 | 20.0 | 15.0 | 0.80 | | | |
| ECWH12183□V() | 0.018 | 23.0 | 7.5 | 16.0 | 21.0 | 20.0 | 15.0 | 0.80 | 400 | | |
| ECWH12203□V() | 0.020 | 23.0 | 8.0 | 16.5 | 21.5 | 20.0 | 15.0 | 0.80 | | | |
| ECWH12223□V() | 0.022 | 23.0 | 8.5 | 16.5 | 21.5 | 20.0 | 15.0 | 0.80 | | | |
| ECWH12243□V() | 0.024 | 23.0 | 8.5 | 17.0 | 22.0 | 20.0 | 15.0 | 0.80 | | | |
| ECWH12273□V() | 0.027 | 23.0 | 9.0 | 17.5 | 22.5 | 20.0 | 15.0 | 0.80 | 300 | | |
| ECWH12303□V() | 0.030 | 23.0 | 9.5 | 18.0 | 23.0 | 20.0 | 15.0 | 0.80 | | | |
| ECWH12333□V() | 0.033 | 23.0 | 10.0 | 18.5 | 23.5 | 20.0 | 15.0 | 0.80 | | | |
| ECWH12363□V() | 0.036 | 23.0 | 10.0 | 19.0 | 24.0 | 20.0 | 15.0 | 0.80 | | | |
| ECWH12393□V() | 0.039 | 23.0 | 10.5 | 19.5 | 24.5 | 20.0 | 15.0 | 0.80 | — | | |
| ECWH12433□V() | 0.043 | 23.0 | 11.0 | 20.0 | 25.0 | 20.0 | 15.0 | 0.80 | | | |
| ECWH12473□V() | 0.047 | 23.0 | 11.5 | 20.5 | 25.5 | 20.0 | 15.0 | 0.80 | | | |
| ECWH12513□V() | 0.051 | 23.0 | 12.0 | 21.0 | 26.0 | 20.0 | 15.0 | 0.80 | | | |
| ECWH12563□V() | 0.056 | 28.0 | 11.5 | 20.0 | 25.0 | 25.0 | 17.5 | 0.80 | | | |
| ECWH12623□V() | 0.062 | 28.0 | 12.0 | 21.0 | 26.0 | 25.0 | 17.5 | 0.80 | | | |
| ECWH12683□V() | 0.068 | 28.0 | 12.5 | 21.5 | 26.5 | 25.0 | 17.5 | 0.80 | | | |
| ECWH12753□V() | 0.075 | 28.0 | 13.5 | 22.0 | 27.0 | 25.0 | 17.5 | 0.80 | | | |
| ECWH12823□V() | 0.082 | 28.0 | 14.0 | 22.5 | 27.5 | 25.0 | 17.5 | 0.80 | | | |
| ECWH12913□V() | 0.091 | 28.0 | 14.5 | 23.0 | 28.0 | 25.0 | 17.5 | 0.80 | | | |
| ECWH12104□V() | 0.10 | 28.0 | 15.5 | 24.0 | 29.0 | 25.0 | 17.5 | 0.80 | | | |

Suffix for lead crimped
 Cap. tol. code

■ Rating & Dimensions

● Rated voltage : 1600 VDC Capacitance tolerance : ±3 %(H), ±5 %(J)

| Part No. | Cap. (μF) | Dimensions (mm) | | | | | | | Min. order Q'ty | | |
|----------------|--------------|------------------|------------------|------------------|--------------|----------|--------------|--------------|-----------------|------------------|------|
| | | L _{max} | T _{max} | H _{max} | | F | | S | ød | Taping 7.5 mm | Bulk |
| | | | | Straight | Crimped lead | Straight | Crimped lead | Crimped lead | | | |
| ECWH16132□V() | 0.0013 | 18.0 | 6.5 | 13.0 | 18.0 | 15.0 | 10.0 | 0.80 | 500 | | |
| ECWH16152□V() | 0.0015 | 18.0 | 6.5 | 13.5 | 18.5 | 15.0 | 10.0 | 0.80 | | | |
| ECWH16162□V() | 0.0016 | 18.0 | 7.0 | 13.5 | 18.5 | 15.0 | 10.0 | 0.80 | | | |
| ECWH16182□V() | 0.0018 | 18.0 | 7.0 | 14.0 | 19.0 | 15.0 | 10.0 | 0.80 | | | |
| ECWH16202□V() | 0.0020 | 18.0 | 7.0 | 14.0 | 19.0 | 15.0 | 10.0 | 0.80 | | | |
| ECWH16222□V() | 0.0022 | 18.0 | 6.5 | 13.5 | 18.5 | 15.0 | 10.0 | 0.80 | | | |
| ECWH16242□V() | 0.0024 | 18.0 | 7.0 | 13.5 | 18.5 | 15.0 | 10.0 | 0.80 | | | |
| ECWH16272□V() | 0.0027 | 18.0 | 7.0 | 14.0 | 19.0 | 15.0 | 10.0 | 0.80 | | | |
| ECWH16302□V() | 0.0030 | 18.0 | 7.5 | 14.0 | 19.0 | 15.0 | 10.0 | 0.80 | 400 | | |
| ECWH16332□V() | 0.0033 | 18.0 | 7.5 | 14.5 | 19.5 | 15.0 | 10.0 | 0.80 | | | |
| ECWH16362□V() | 0.0036 | 18.0 | 7.0 | 13.5 | 18.5 | 15.0 | 10.0 | 0.80 | 500 | | |
| ECWH16392□V() | 0.0039 | 18.0 | 7.0 | 14.0 | 19.0 | 15.0 | 10.0 | 0.80 | | | |
| ECWH16432□V() | 0.0043 | 18.0 | 7.0 | 14.0 | 19.0 | 15.0 | 10.0 | 0.80 | | | |
| ECWH16472□V() | 0.0047 | 23.0 | 6.5 | 14.5 | 19.5 | 20.0 | 15.0 | 0.80 | | | |
| ECWH16512□V() | 0.0051 | 23.0 | 6.5 | 15.0 | 20.0 | 20.0 | 15.0 | 0.80 | | | |
| ECWH16562□V() | 0.0056 | 23.0 | 6.5 | 15.0 | 20.0 | 20.0 | 15.0 | 0.80 | | | |
| ECWH16622□V() | 0.0062 | 23.0 | 7.0 | 15.0 | 20.0 | 20.0 | 15.0 | 0.80 | | | |
| ECWH16682□V() | 0.0068 | 23.0 | 7.0 | 15.5 | 20.5 | 20.0 | 15.0 | 0.80 | | | |
| ECWH16752□V() | 0.0075 | 23.0 | 7.5 | 15.5 | 20.5 | 20.0 | 15.0 | 0.80 | 400 | 500 | |
| ECWH16822□V() | 0.0082 | 23.0 | 7.5 | 16.0 | 21.0 | 20.0 | 15.0 | 0.80 | | | |
| ECWH16912□V() | 0.0091 | 23.0 | 8.0 | 16.0 | 21.0 | 20.0 | 15.0 | 0.80 | | | |
| ECWH16103□V() | 0.010 | 23.0 | 8.0 | 16.5 | 21.5 | 20.0 | 15.0 | 0.80 | | | |
| ECWH16113□V() | 0.011 | 23.0 | 8.5 | 17.0 | 22.0 | 20.0 | 15.0 | 0.80 | 300 | | |
| ECWH16123□V() | 0.012 | 23.0 | 9.0 | 17.0 | 22.0 | 20.0 | 15.0 | 0.80 | | | |
| ECWH16133□V() | 0.013 | 23.0 | 9.0 | 17.5 | 22.5 | 20.0 | 15.0 | 0.80 | | | |
| ECWH16153□V() | 0.015 | 23.0 | 9.5 | 18.0 | 23.0 | 20.0 | 15.0 | 0.80 | | | |
| ECWH16163□V() | 0.016 | 23.0 | 10.0 | 18.5 | 23.5 | 20.0 | 15.0 | 0.80 | | | |
| ECWH16183□V() | 0.018 | 23.0 | 10.5 | 19.5 | 24.5 | 20.0 | 15.0 | 0.80 | | | |
| ECWH16203□V() | 0.020 | 23.0 | 11.0 | 20.0 | 25.0 | 20.0 | 15.0 | 0.80 | | | |
| ECWH16223□V() | 0.022 | 28.0 | 9.5 | 18.0 | 23.0 | 25.0 | 17.5 | 0.80 | | | — |
| ECWH16243□V() | 0.024 | 28.0 | 10.0 | 18.5 | 23.5 | 25.0 | 17.5 | 0.80 | | | |
| ECWH16273□V() | 0.027 | 28.0 | 10.5 | 19.5 | 24.5 | 25.0 | 17.5 | 0.80 | | | |
| ECWH16303□V() | 0.030 | 28.0 | 11.0 | 20.0 | 25.0 | 25.0 | 17.5 | 0.80 | | | |
| ECWH16333□V() | 0.033 | 28.0 | 11.5 | 20.5 | 25.5 | 25.0 | 17.5 | 0.80 | | | |
| ECWH16363□V() | 0.036 | 28.0 | 12.5 | 21.5 | 26.5 | 25.0 | 17.5 | 0.80 | | | |
| ECWH16393□V() | 0.039 | 28.0 | 13.5 | 22.0 | 27.0 | 25.0 | 17.5 | 0.80 | | | |
| ECWH16433□V() | 0.043 | 28.0 | 14.5 | 22.5 | 27.5 | 25.0 | 17.5 | 0.80 | | | |
| ECWH16473□V() | 0.047 | 28.0 | 15.0 | 23.5 | 28.5 | 25.0 | 17.5 | 0.80 | | | |
| ECWH16513□V() | 0.051 | 28.0 | 15.5 | 24.0 | 29.0 | 25.0 | 17.5 | 0.80 | | | |
| ECWH16563□V() | 0.056 | 28.0 | 16.0 | 24.5 | 29.5 | 25.0 | 17.5 | 0.80 | | | |

Suffix for lead crimped
 Cap. tol. code

Metallized Film

■ Rating & Dimensions

● Rated voltage : 2000 VDC Capacitance tolerance : $\pm 3\%$ (H), $\pm 5\%$ (J)

| Part No. | Cap. (μF) | Dimensions | | | | | | | Min. order Q'ty | | |
|----------------|---------------------------|------------------|------------------|------------------|--------------|----------|--------------|------|-----------------|------------------|------|
| | | L _{max} | T _{max} | H _{max} | | F | | S | | Taping 7.5 mm | Bulk |
| | | | | Straight | Crimped lead | Straight | Crimped lead | ød | | | |
| ECWH20102□V() | 0.0010 | 18.0 | 6.5 | 13.5 | 18.5 | 15.0 | 10.0 | 0.80 | 500 | 500 | |
| ECWH20112□V() | 0.0011 | 18.0 | 6.5 | 13.5 | 18.5 | 15.0 | 10.0 | 0.80 | | | |
| ECWH20122□V() | 0.0012 | 18.0 | 7.0 | 13.5 | 18.5 | 15.0 | 10.0 | 0.80 | | | |
| ECWH20132□V() | 0.0013 | 18.0 | 7.0 | 14.0 | 19.0 | 15.0 | 10.0 | 0.80 | | | |
| ECWH20152□V() | 0.0015 | 18.0 | 7.5 | 14.0 | 19.0 | 15.0 | 10.0 | 0.80 | 400 | | |
| ECWH20162□V() | 0.0016 | 18.0 | 7.5 | 14.5 | 19.5 | 15.0 | 10.0 | 0.80 | | | |
| ECWH20182□V() | 0.0018 | 18.0 | 8.0 | 14.5 | 19.5 | 15.0 | 10.0 | 0.80 | | | |
| ECWH20202□V() | 0.0020 | 18.0 | 8.0 | 15.0 | 20.0 | 15.0 | 10.0 | 0.80 | | | |
| ECWH20222□V() | 0.0022 | 18.0 | 8.5 | 15.0 | 20.0 | 15.0 | 10.0 | 0.80 | 300 | | |
| ECWH20242□V() | 0.0024 | 18.0 | 8.5 | 15.5 | 20.5 | 15.0 | 10.0 | 0.80 | | | |
| ECWH20272□V() | 0.0027 | 18.0 | 9.0 | 16.0 | 21.0 | 15.0 | 10.0 | 0.80 | | | |
| ECWH20302□V() | 0.0030 | 18.0 | 9.5 | 16.0 | 21.0 | 15.0 | 10.0 | 0.80 | | | |
| ECWH20332□V() | 0.0033 | 18.0 | 8.5 | 15.5 | 20.5 | 15.0 | 10.0 | 0.80 | 400 | | |
| ECWH20362□V() | 0.0036 | 18.0 | 9.0 | 15.5 | 20.5 | 15.0 | 10.0 | 0.80 | | | |
| ECWH20392□V() | 0.0039 | 18.0 | 9.0 | 16.0 | 21.0 | 15.0 | 10.0 | 0.80 | 300 | | |
| ECWH20432□V() | 0.0043 | 18.0 | 9.5 | 16.0 | 21.0 | 15.0 | 10.0 | 0.80 | | | |
| ECWH20472□V() | 0.0047 | 23.0 | 7.0 | 15.5 | 20.5 | 20.0 | 15.0 | 0.80 | 500 | | |
| ECWH20512□V() | 0.0051 | 23.0 | 7.5 | 16.0 | 21.0 | 20.0 | 15.0 | 0.80 | | | |
| ECWH20562□V() | 0.0056 | 23.0 | 7.5 | 16.0 | 21.0 | 20.0 | 15.0 | 0.80 | 400 | | |
| ECWH20622□V() | 0.0062 | 23.0 | 8.0 | 16.5 | 21.5 | 20.0 | 15.0 | 0.80 | | | |
| ECWH20682□V() | 0.0068 | 23.0 | 8.5 | 16.5 | 21.5 | 20.0 | 15.0 | 0.80 | | | |
| ECWH20752□V() | 0.0075 | 23.0 | 9.5 | 18.0 | 23.0 | 20.0 | 15.0 | 0.80 | | | |
| ECWH20822□V() | 0.0082 | 23.0 | 10.0 | 18.0 | 23.0 | 20.0 | 15.0 | 0.80 | 300 | | |
| ECWH20912□V() | 0.0091 | 23.0 | 10.0 | 19.0 | 24.0 | 20.0 | 15.0 | 0.80 | | | |
| ECWH20103□V() | 0.010 | 23.0 | 10.5 | 19.5 | 24.5 | 20.0 | 15.0 | 0.80 | | | |
| ECWH20113□V() | 0.011 | 23.0 | 11.0 | 20.0 | 25.0 | 20.0 | 15.0 | 0.80 | | | |
| ECWH20123□V() | 0.012 | 23.0 | 11.5 | 20.5 | 25.5 | 20.0 | 15.0 | 0.80 | | | |
| ECWH20133□V() | 0.013 | 23.0 | 12.0 | 21.0 | 26.0 | 20.0 | 15.0 | 0.80 | | | |
| ECWH20153□V() | 0.015 | 23.0 | 12.0 | 21.5 | 26.5 | 20.0 | 15.0 | 0.80 | | | |

— Suffix for lead crimped
 — Cap. tol. code



ECWH(V) Type 1000VDC Series (Metallized Polypropylene Film)

Electrical Characteristics <Typical Data>

Temperature Characteristics

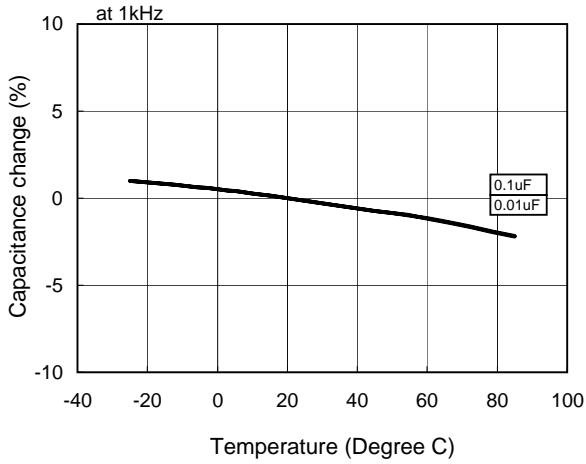

Frequency Characteristics

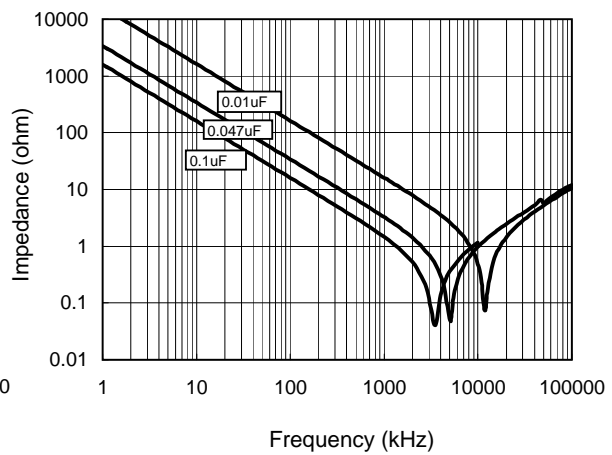
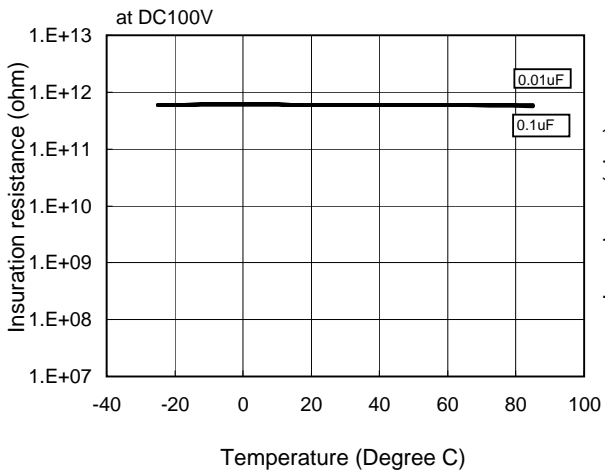
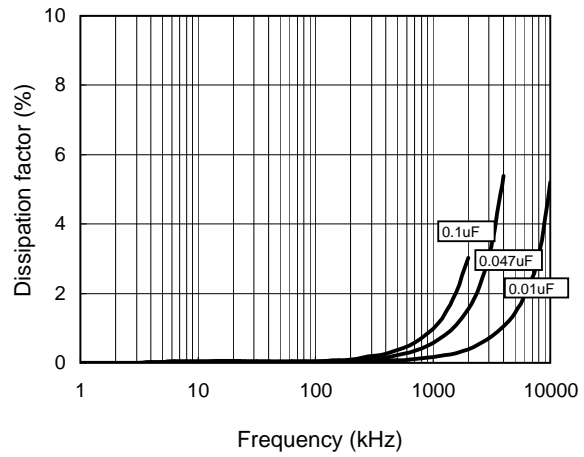
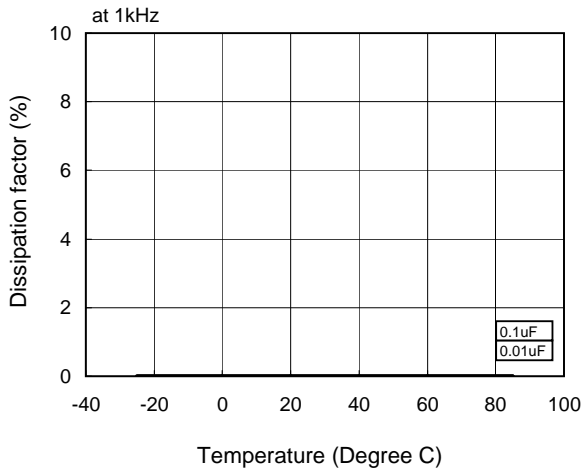
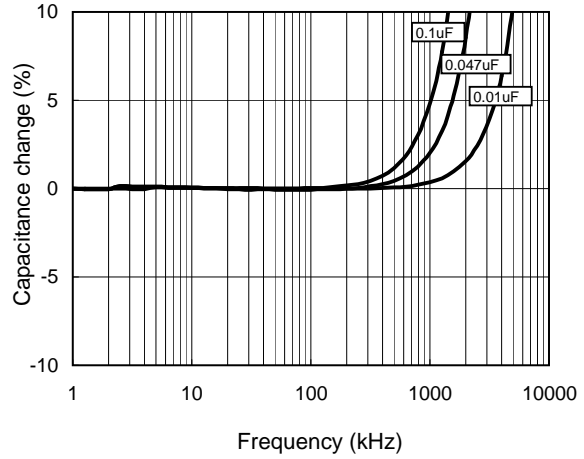



ECWH(V) Type 1000VDC Series (Metallized Polypropylene Film)

Applicable Specifications

Permissible Current

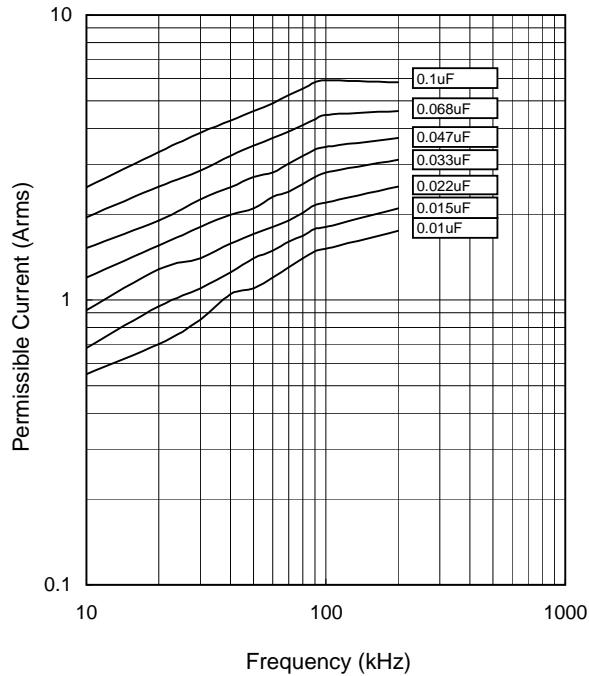

Voltage Derating by Temperature

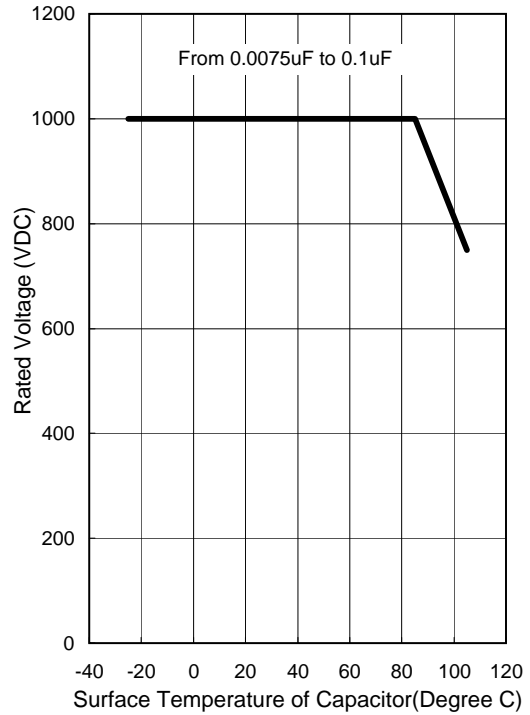

Pulse Handling Capability (dV/dt)

(Max 10000cycles)

| Rating Voltage | Capacitance Value(uF) | Code | dV/dt(V/us) | Current(o-p) (A) |
|----------------|-----------------------|------|-------------|------------------|
| 1000VDC | 0.0100 | 103 | 6000 | 60.0 |
| | 0.0150 | 153 | | 90.0 |
| | 0.0220 | 223 | | 132.0 |
| | 0.0330 | 333 | | 198.0 |
| | 0.0470 | 473 | | 282.0 |
| | 0.0680 | 683 | | 408.0 |
| | 0.1000 | 104 | | 600.0 |

* Please consult Panasonic if your condition exceeds the above spec.



ECWH(V) Type 1250VDC Series (Metallized Polypropylene Film)

Erectrical Characteristics <Typical Data>

Temperature Characteristics

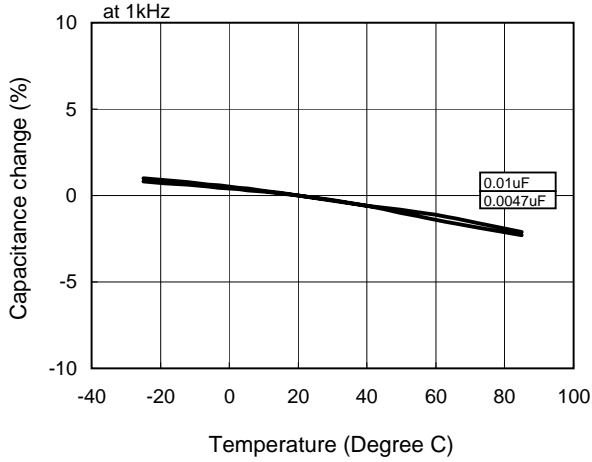

Frequency Characteristics

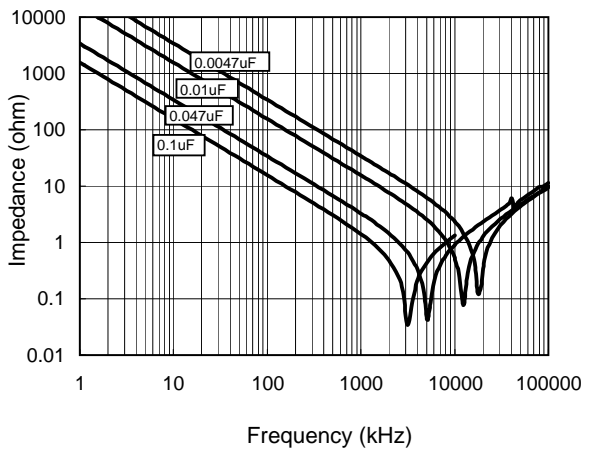
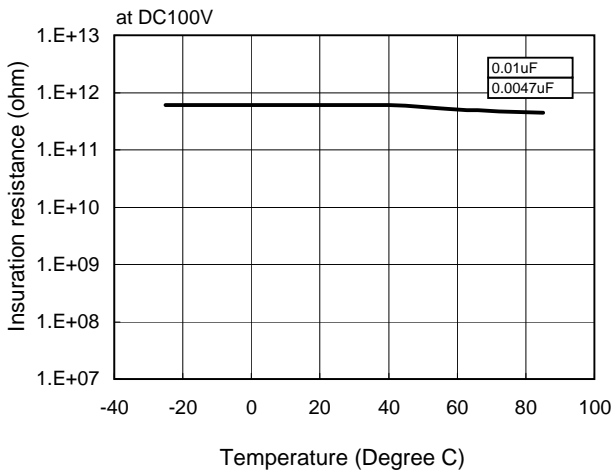
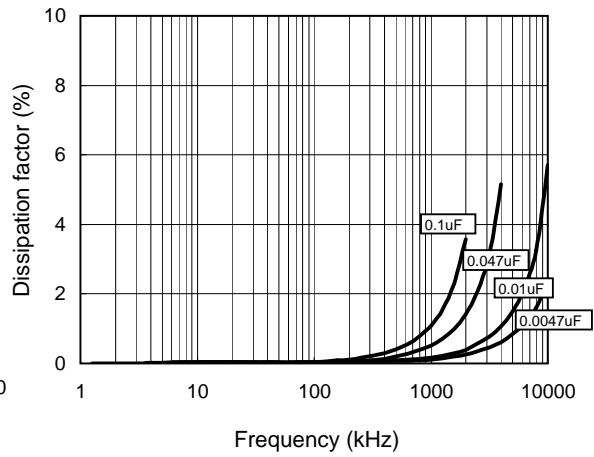
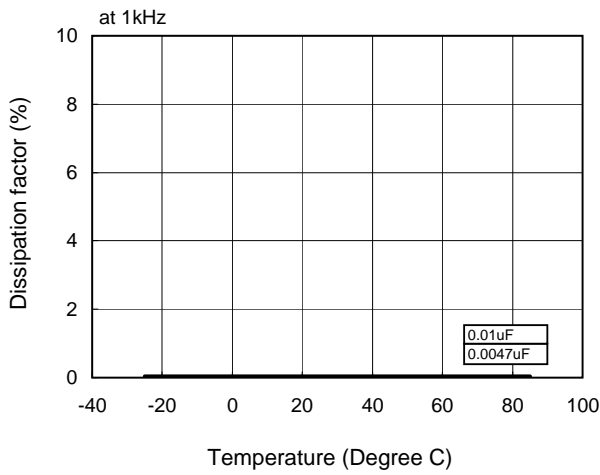
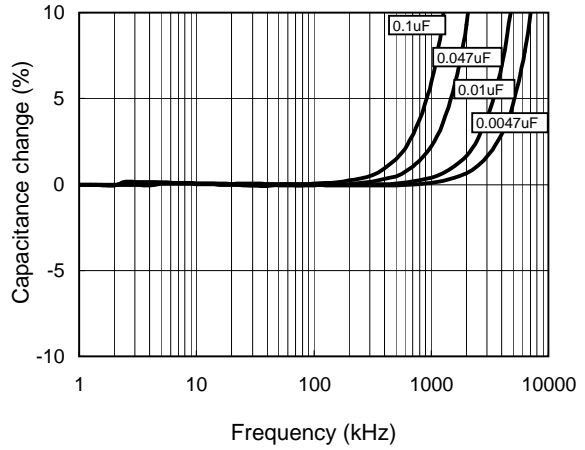



ECWH(V) Type 1250VDC Series (Metallized Polypropylene Film)

Applicable Specifications

Permissible Current

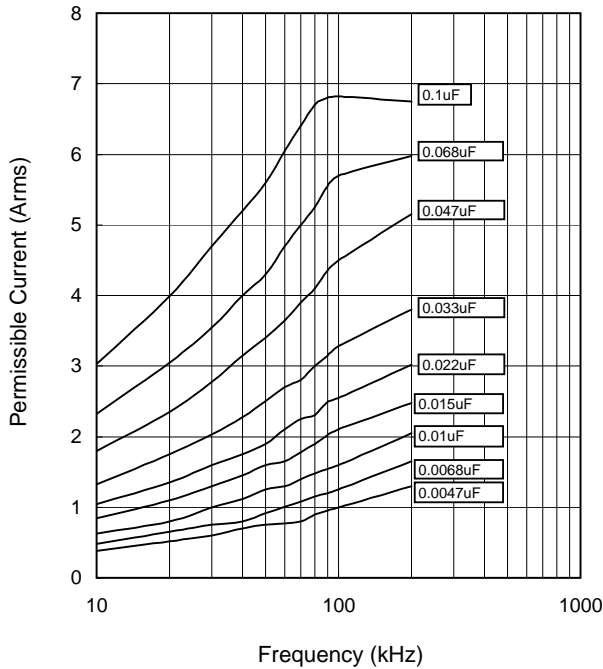

Voltage Derating by Temperature

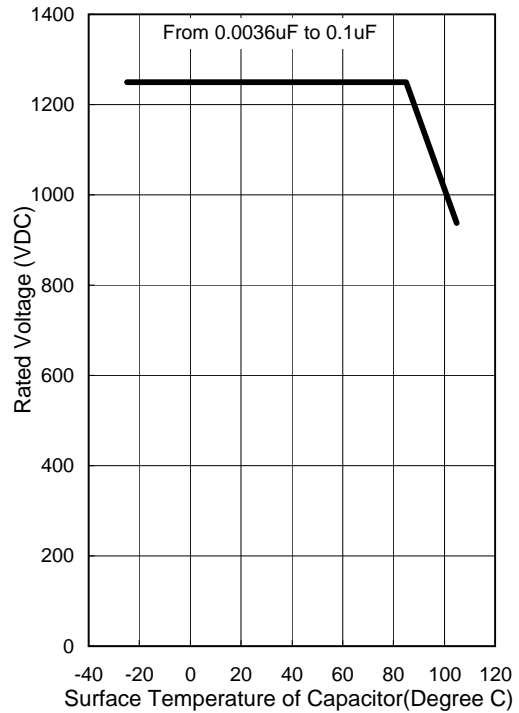

Pulse Handling Capability (dV/dt)

(Max 10000cycles)

| Rating Voltage | Capacitance Value(uF) | Code | dV/dt(V/us) | Current(o-p) (A) |
|----------------|-----------------------|------|-------------|------------------|
| 1250VDC | 0.0047 | 472 | 6000 | 28.2 |
| | 0.0068 | 682 | | 40.8 |
| | 0.0100 | 103 | | 60.0 |
| | 0.0150 | 153 | | 90.0 |
| | 0.0220 | 223 | | 132.0 |
| | 0.0330 | 333 | | 198.0 |
| | 0.0470 | 473 | | 282.0 |
| | 0.0680 | 683 | | 408.0 |
| | 0.1000 | 104 | | 600.0 |

* Please consult Panasonic if your condition exceeds the above spec.



ECWH(V) Type 1600VDC Series (Metallized Polypropylene Film)

Electrical Characteristics <Typical Data>

Temperature Characteristics

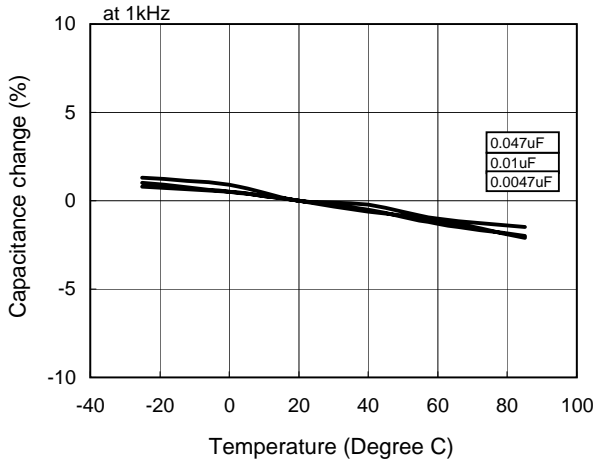

Frequency Characteristics

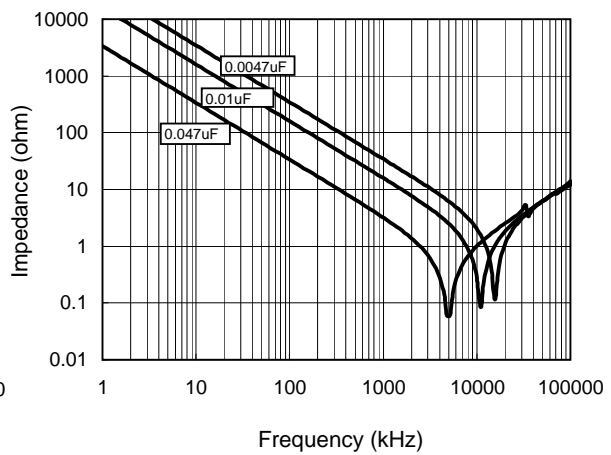
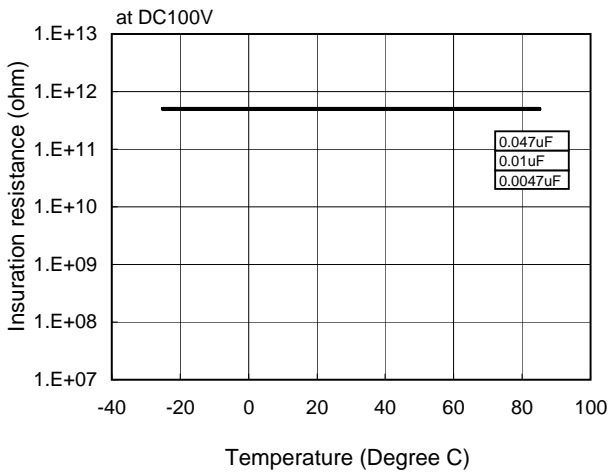
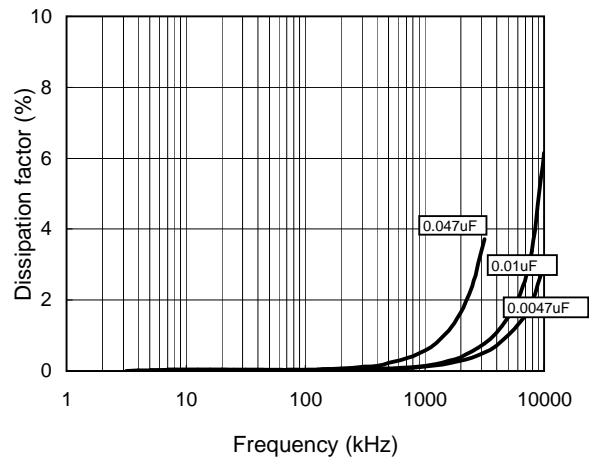
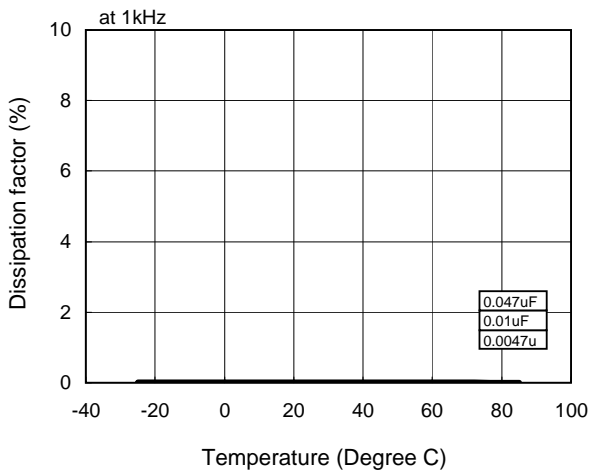
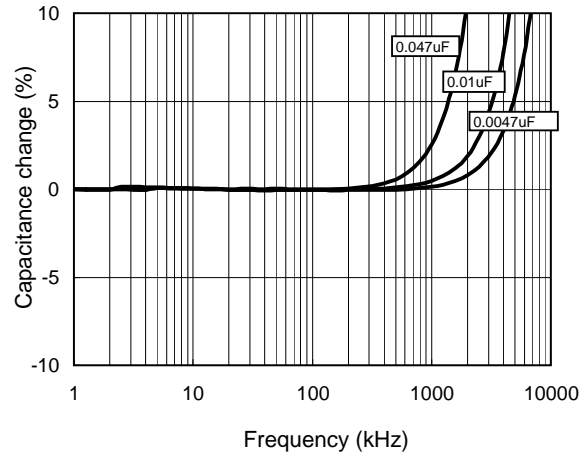



ECWH(V) Type 1600VDC Series (Metallized Polypropylene Film)

Applicable Specifications

Permissible Current

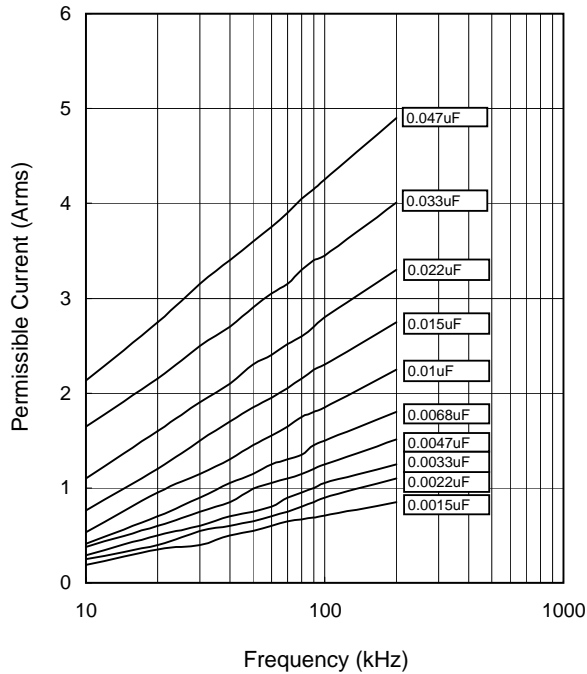

Voltage Derating by Temperature

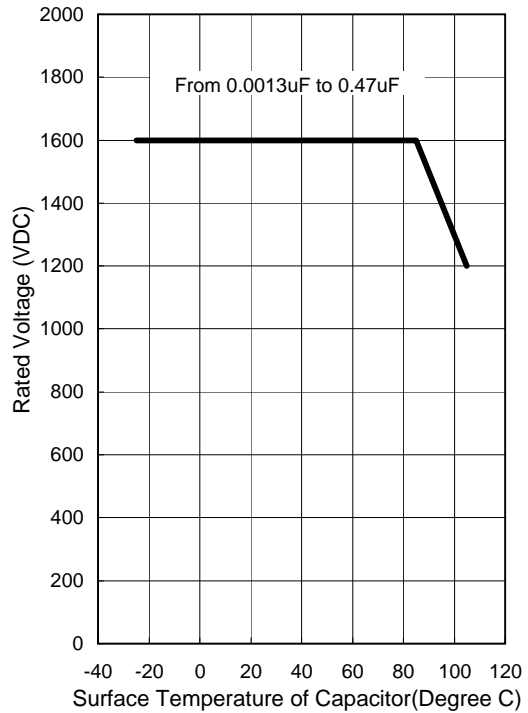

Pulse Handling Capability (dV/dt)

(Max 10000cycles)

| Rating Voltage | Capacitance Value(uF) | Code | dV/dt(V/us) | Current(o-p) (A) |
|----------------|-----------------------|------|-------------|------------------|
| 1600VDC | 0.0015 | 152 | 6000 | 9.0 |
| | 0.0022 | 222 | | 13.2 |
| | 0.0033 | 332 | | 19.8 |
| | 0.0047 | 472 | | 28.2 |
| | 0.0068 | 682 | | 40.8 |
| | 0.0100 | 103 | | 60.0 |
| | 0.0150 | 153 | | 90.0 |
| | 0.0220 | 223 | | 132.0 |
| | 0.0330 | 333 | | 198.0 |
| | 0.0470 | 473 | | 282.0 |

* Please consult Panasonic if your condition exceeds the above spec.



ECWH(V) Type 2000VDC Series (Metallized Polypropylene Film)

Erectrical Characteristics <Typical Data>

Temperature Characteristics

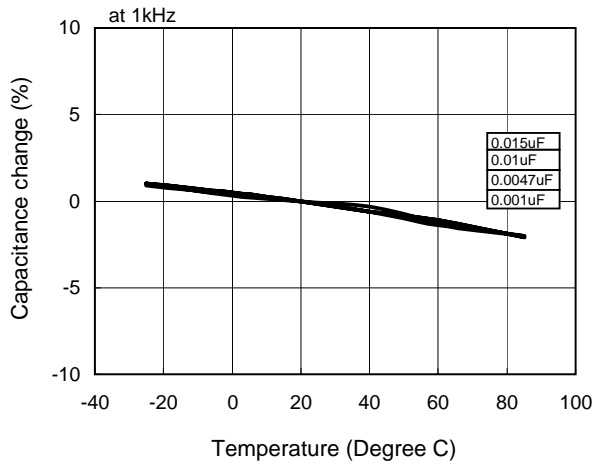

Frequency Characteristics

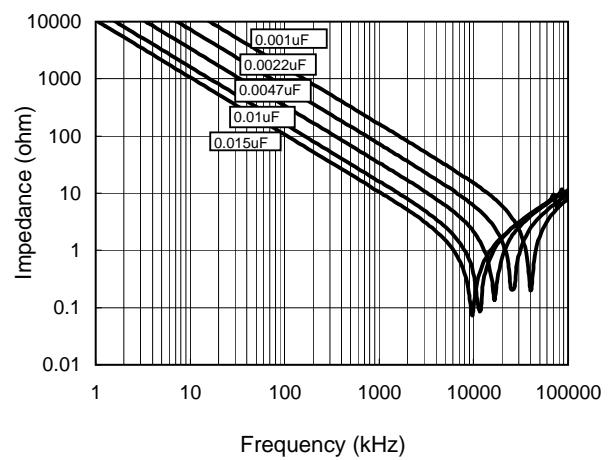
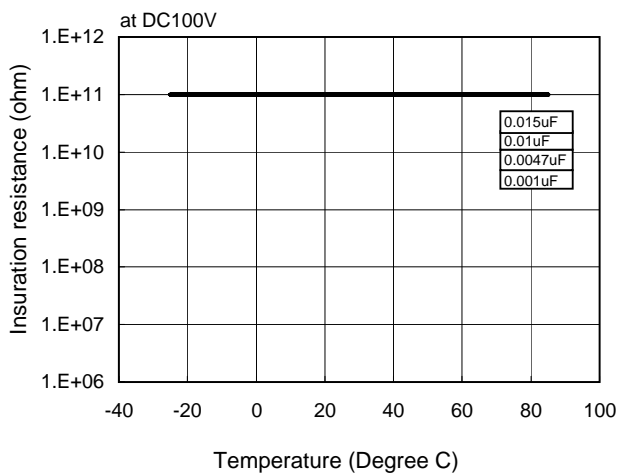
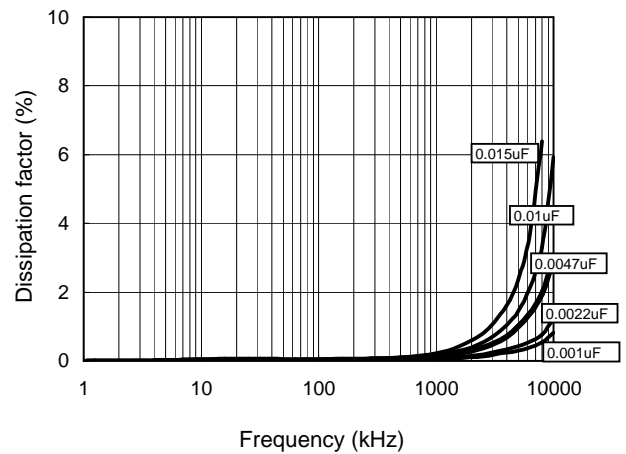
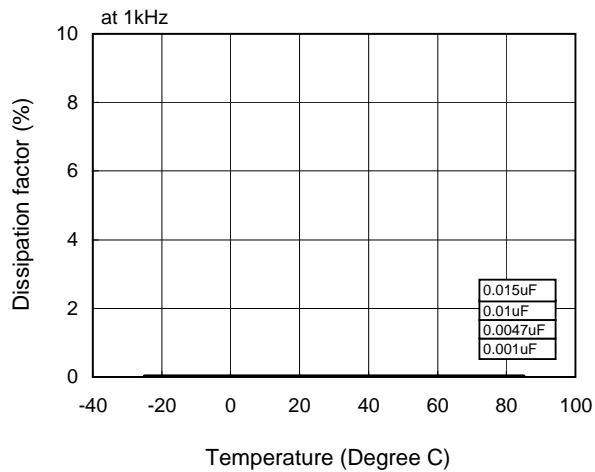
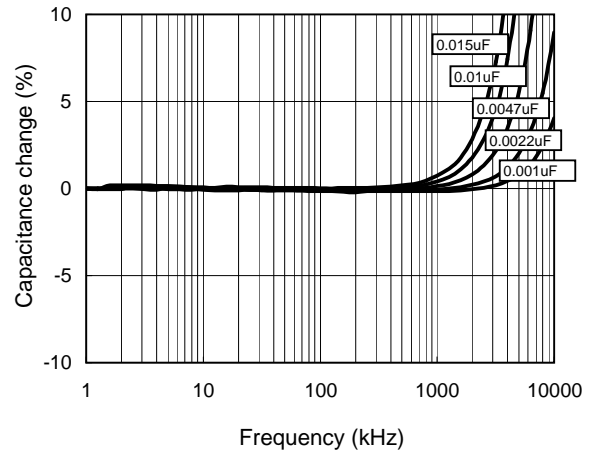



ECWH(V) Type 2000VDC Series (Metallized Polypropylene Film)

Applicable Specifications

Permissible Current

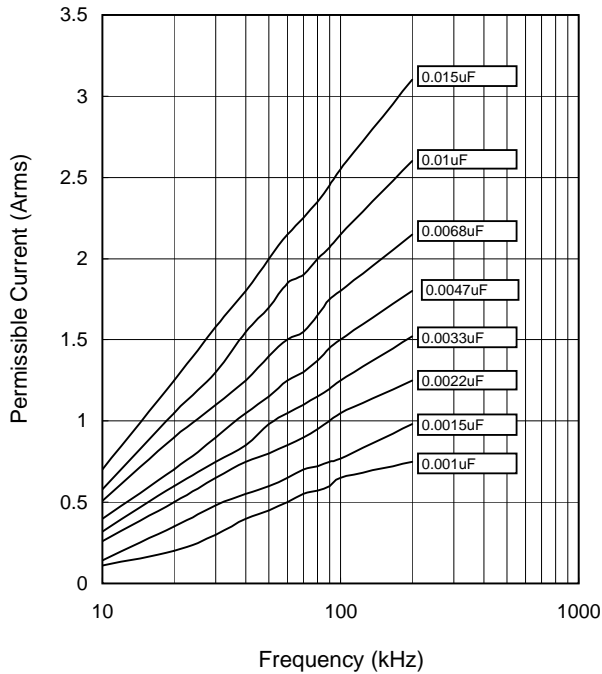

Voltage Derating by Temperature

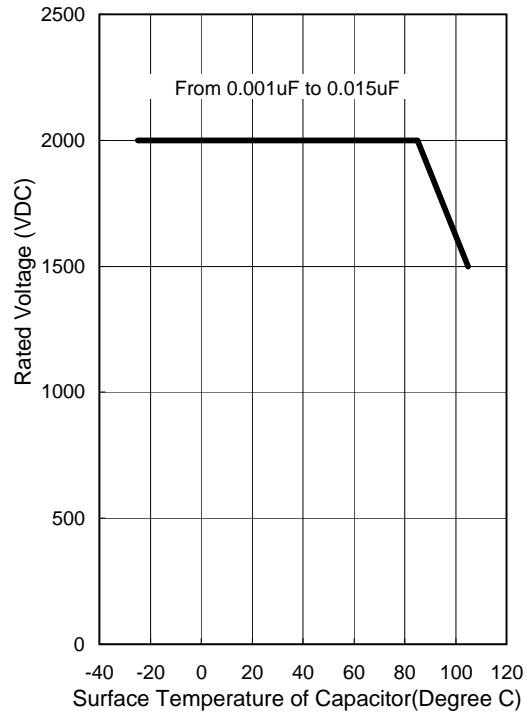

Pulse Handling Capability (dV/dt)

(Max 10000cycles)

| Rating Voltage | Capacitance Value(uF) | Code | dV/dt(V/us) | Current(o-p) (A) |
|----------------|-----------------------|------|-------------|------------------|
| 2000VDC | 0.0010 | 102 | 6000 | 6.0 |
| | 0.0015 | 152 | | 9.0 |
| | 0.0022 | 222 | | 13.2 |
| | 0.0033 | 332 | | 19.8 |
| | 0.0047 | 472 | | 28.2 |
| | 0.0068 | 682 | | 40.8 |
| | 0.0100 | 103 | | 60.0 |
| | 0.0150 | 153 | | 90.0 |

* Please consult Panasonic if your condition exceeds the above spec.