

# ECS65 Series

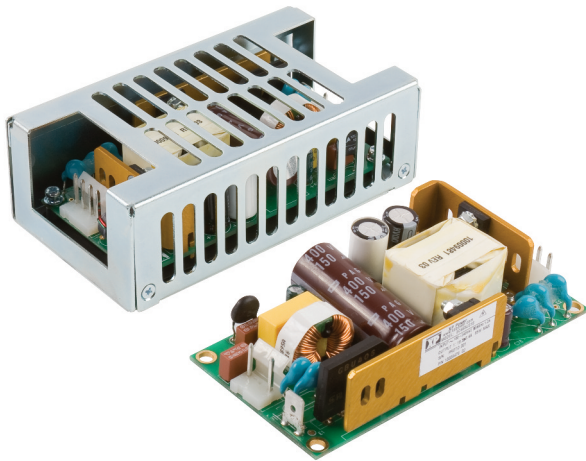

- IT & Medical Safety Approvals
- <0.5 W Standby Power
- 65 W Convection Cooled Rating
- Industry Standard 2.0" x 4.0" x 1.05" Format
- Low Earth Leakage Current
- Class B Radiated Emissions (-B models)
- Low Temperature Operation
- 3 Year Warranty

The ECS65 Series has been designed to minimise the no load power consumption (<0.5 W) and maximise efficiency in order to facilitate equipment design to the latest environmental legislation.

Approved for Class I applications, the ECS65 range of single output AC-DC, 65 W power supplies feature high power density in an industry standard 2 x 4" (51.0 mm x 102.0 mm) footprint. The 1.05" (27.0 mm) high, 1U compatible high-density power supplies meet EN55032 Level B emissions with low earth leakage currents of 110  $\mu$ A at 115 VAC or 210  $\mu$ A at 230 VAC. Making these switchers ideal for industrial, IT and medical applications.

The ECS65 series has single output versions from 12 V to 48 VDC which are adjustable by  $\pm$ 10%. They are dual-fused for compliance with IEC60601-1 and with typical efficiencies at 88%, minimal waste heat is generated. The ECS65 delivers a full 65 W of power up to +50 °C and operates at up to +70 °C with derating.

## Models and Ratings

Output Power - Convection Cooled	Output Voltage V1	Max Output Current	Model Number <sup>1)</sup>
65 W	12.0VDC	5.4 A	ECS65US12
65 W	15.0VDC	4.3 A	ECS65US15
65 W	18.5VDC	3.4 A	ECS65US18
65 W	24.0VDC	2.7 A	ECS65US24
65 W	28.0VDC	2.3 A	ECS65US28
65 W	48.0VDC	1.4 A	ECS65US48

**Notes:**  
 1. For Class B radiated emissions models, add suffix -B to model number. For covered versions, add suffix '-C' to model number or order part no. ECM40/60 COVER for standalone cover. Derate output power by 20% with cover. The cover is not suitable for Class II installations.

## Input Characteristics

Characteristic	Minimum	Typical	Maximum	Units	Notes & Conditions
Input Voltage - Operating	80	115/230	264	VAC	Derate output power < 90 VAC. See fig. 1
Input Frequency	47	50/60	400	Hz	400Hz for ECS65 only
Power Factor		>0.5			230 VAC, 100% load EN61000-3-2 class A compliant
Input Current - No Load		0.02/0.03		A	115/230 VAC
Input Current - Full Load		1.0/0.6		A	115/230 VAC
Inrush Current			40	A	230 VAC cold start, 25 °C
No Load Input Power		0.4	0.5	W	
Earth Leakage Current		110/210	260	µA	115/230 VAC/50 Hz (Typ.), 264 VAC/60 Hz (Max.)
		0.7/1.5		mA	115/230 VAC/400 Hz
Input Protection	T3.15A/250 V internal fuse in both line and neutral				

## Output Characteristics

Characteristic	Minimum	Typical	Maximum	Units	Notes & Conditions
Output Voltage - V1	12		48	VDC	See Models and Ratings table
Initial Set Accuracy			±1	%	50% load, 115/230 VAC
Output Voltage Adjustment	±10			%	Via potentiometer. See mech. details (page 9)
Minimum Load	0			A	
Start Up Delay		1		s	230 VAC full load (see fig.2)
Hold Up Time	16			ms	115 VAC full load (see fig.3)
Drift			±0.2	%	After 20 min warm up
Line Regulation			±0.5	%	90-264 VAC
Load Regulation			±1	%	0-100% load.
Transient Response - V1			4	%	Recovery within 1% in less than 500 µs for a 50-75% and 75-50% load step
Over/Undershoot - V1		5		%	See fig.4
Ripple & Noise			1	% pk-pk	20 MHz bandwidth (see fig.5 & 6)
Overvoltage Protection	115		140	%	Vnom DC.
Overload Protection	110		160	% I nom	Auto reset (see fig.7)
Short Circuit Protection					Continuous, trip & restart (hiccup mode)
Temperature Coefficient			0.05	%/°C	
Overttemperature Protection				°C	Not fitted

## Input Voltage Derating

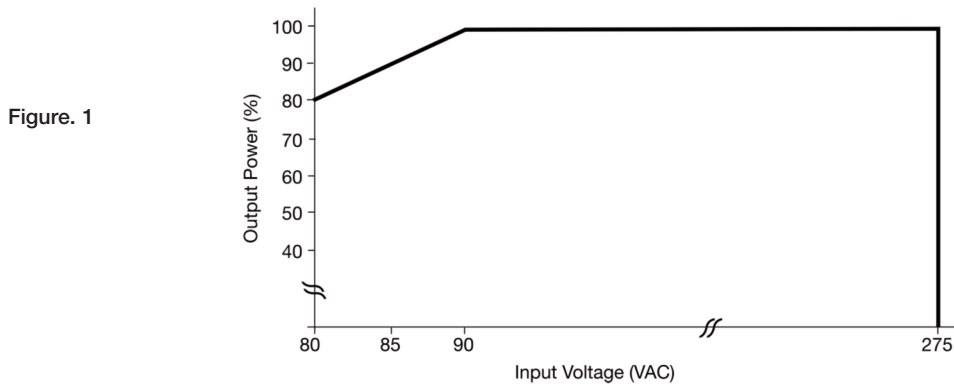

## Start Up Delay From AC Turn On

Figure 2  
Start up example from AC turn on  
(230 VAC, 270 ms)

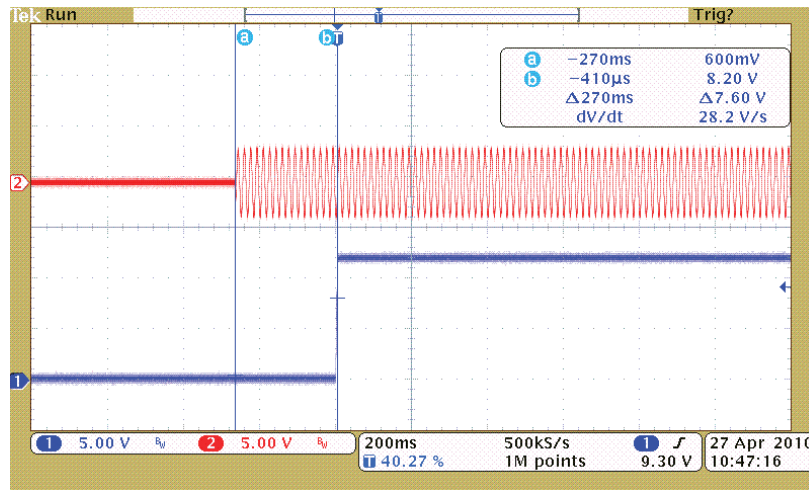

## Hold Up Time From Loss of AC

Figure 3  
Hold up example at 65 W load  
with 115 VAC input (20.1 ms)

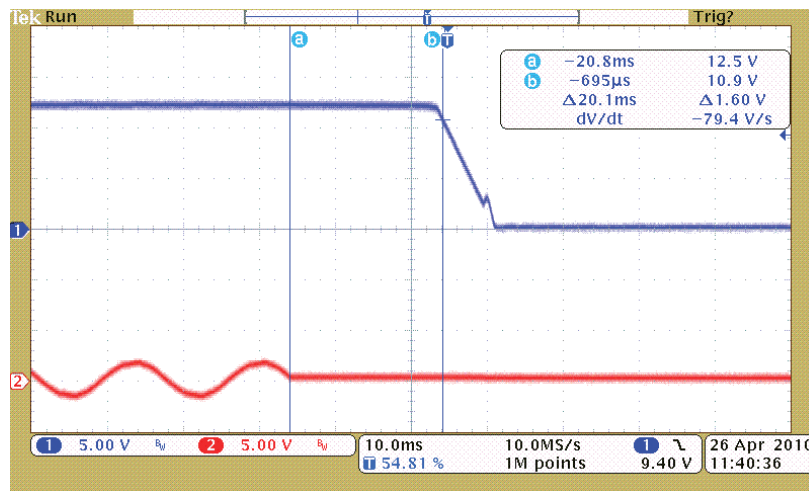

## Typical Output Overshoot

Figure 4  
Typical Output Overshoot  
(ECS65US12, 230 VAC)

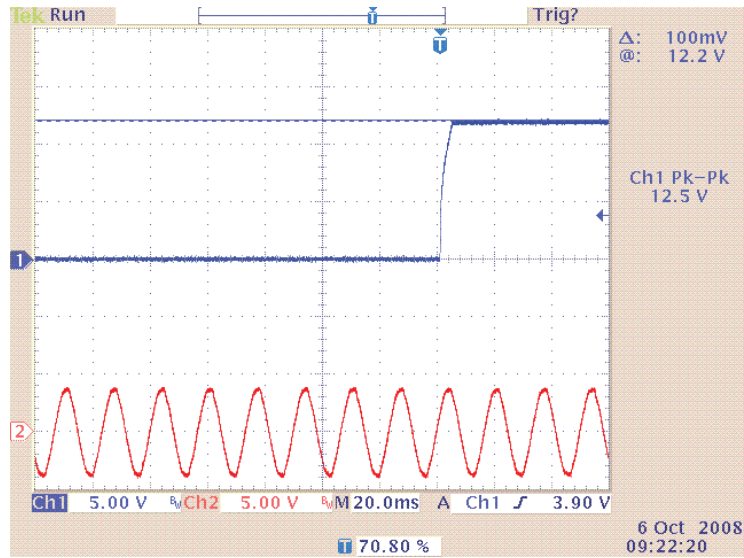

## Output Ripple & Noise

Figure 5  
ECS65US12 (65 W)  
96 mV pk-pk ripple. 20 MHz BW

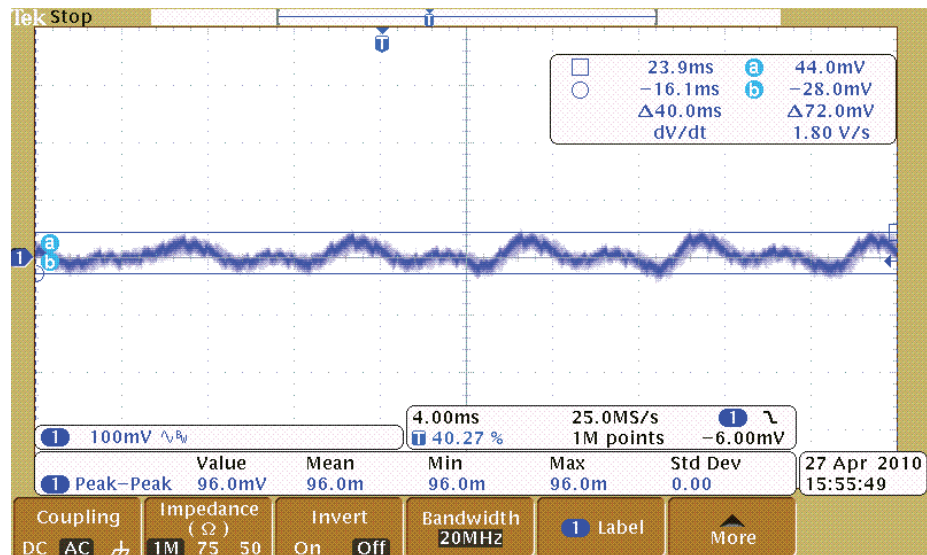

## Output Ripple & Noise cont.

Figure 6  
ECS65US24 (65 W)  
112 mV pk-pk ripple. 20 MHz BW

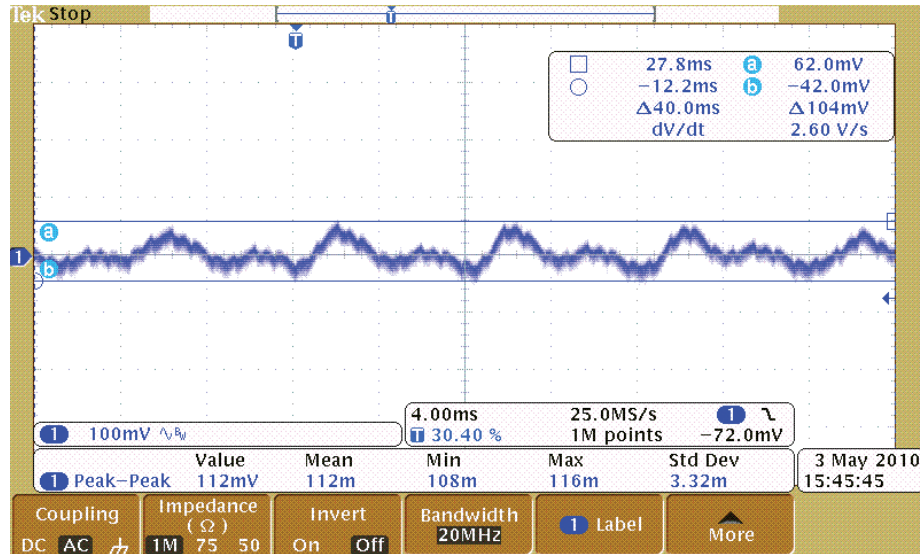

## Output Overload Characteristic

Figure 7  
Typical Overload  
Characteristic  
(ECS65US12 shown)

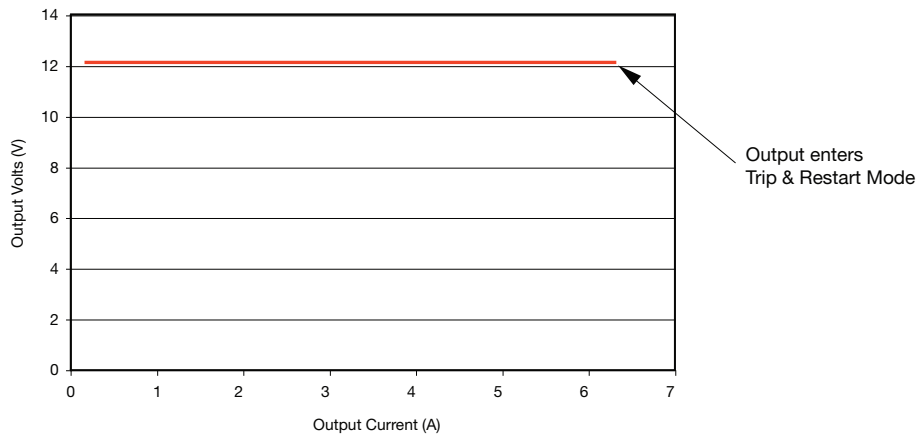

## General Specifications

Characteristic	Minimum	Typical	Maximum	Units	Notes & Conditions
Efficiency		88		%	Full load (see fig.8 & 9)
Isolation: Input to Output Input to Ground Output to Ground	4000			VAC	
	1500			VAC	
	500			VDC	
Switching Frequency		65		kHz	
Power Density			7.7	W/in <sup>2</sup>	
Mean Time Between Failure		850		kHrs	MIL-HDBK-217F, Notice 2 +25 °C GB
Weight			0.28 (125)	lb (g)	

## Efficiency Versus Load

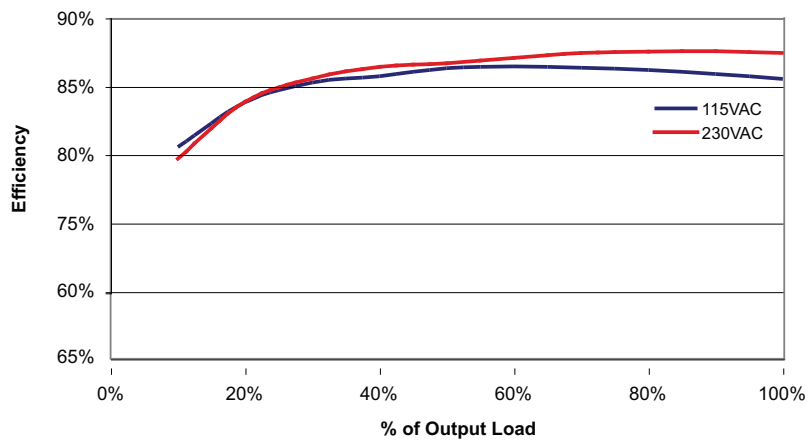

Figure 8 - ECS65US12

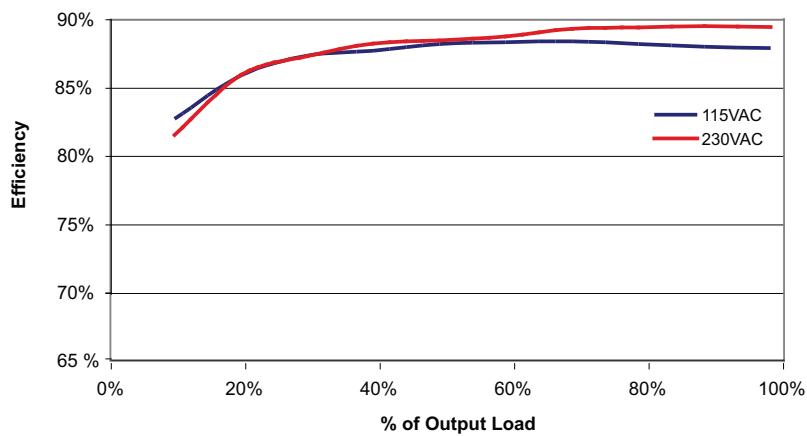

Figure 9 - ECS65US24

## Environmental

Characteristic	Minimum	Typical	Maximum	Units	Notes & Conditions
Operating Temperature	-20		+70	°C	Derate linearly from +50 °C at 2.5%/°C to 50% at 70 °C. (See fig.10 & Thermal Considerations)
Storage Temperature	-40		+85	°C	
Cooling					Convection Cooled See fig.10 & Thermal Considerations
Humidity	5		95	%RH	Non-condensing
Operating Altitude			3000	m	
Shock					3 x 30 g/11 ms shocks in both +ve & -ve directions along the 3 orthogonal axis, total 18 shocks.
Vibration					Three axis 5-500 Hz at 2 g x 10 sweeps

## Derating Curve

Figure 10

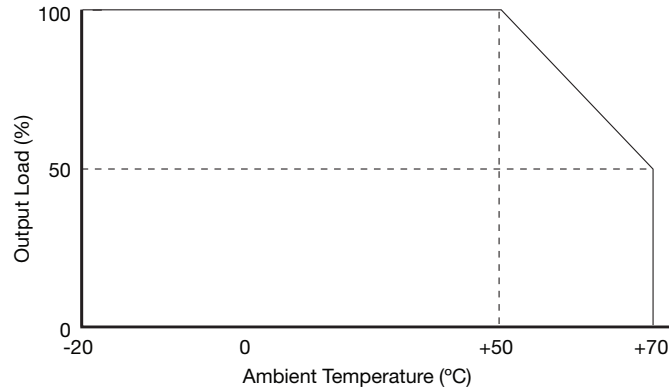

## Electromagnetic Compatibility - Immunity

Phenomenon	Standard	Test Level	Criteria	Notes & Conditions
Low Voltage PSU EMC	EN61204-3	High severity level	as below	
Harmonic Current	EN61000-3-2	Class A		
ESD Immunity	EN61000-4-2	±6 kV Contact ±15 kV Air Discharge	A	
Radiated	EN61000-4-3	3	A	
EFT	EN61000-4-4	3	A	
Surges	EN61000-4-5	Installation class 3	A	
Conducted	EN61000-4-6	3	A	
Dips and Interruptions	EN61000-4-11	Dip: 30% 10 ms	A	
		Dip: 60% 100 ms	B	
		Dip: 100% 5000 ms	B	
	EN60601-1-2	Dip: 30% 500 ms	A	
		Dip: 60% 100 ms	A	Load derating with 115 VAC input (typically 80% derate dependant on model & load)
		Dip: 100% 10 ms	A	
		Int.: >95% 5000 ms	B	

## Electromagnetic Compatibility - Emissions

Phenomenon	Standard	Test Level	Criteria	Notes & Conditions
Conducted	EN55011/32	Class B		See fig. 11
Radiated	EN55011/32	Class A		
		Class B		ECS65-B models
Voltage Fluctuations	EN61000-3-3			

### Typical EMC Plot

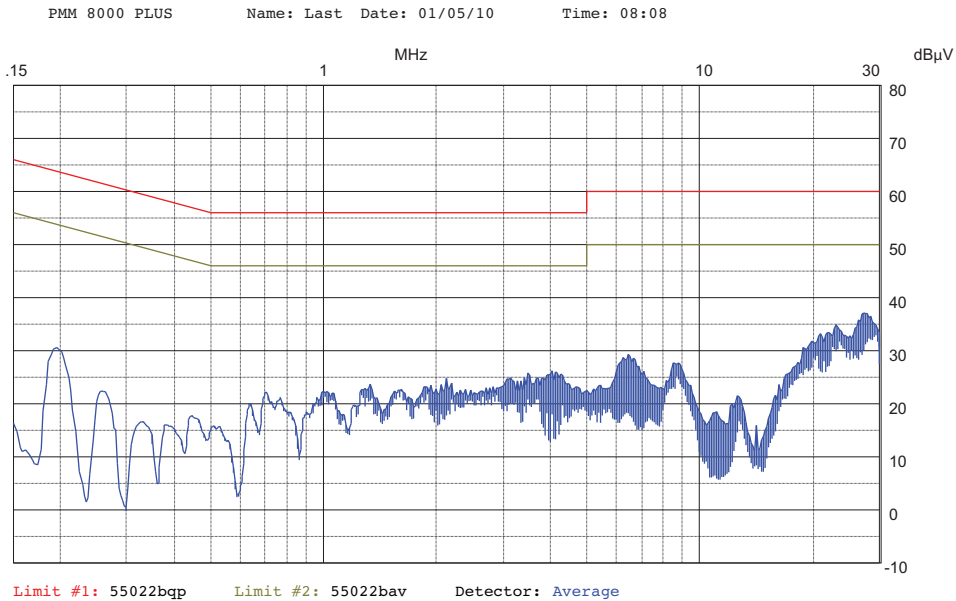

Figure 11  
Typical conducted noise plot

### Safety Agency Approvals

Safety Agency	Safety Standard	Category
CB Report	IEC60950-1:2005 Ed 2 / IEC62368-1:2014	Information Technology
UL	UL 62368-1 & CAN/CSA C22.2 No. 62368-1-14	Information Technology
TUV	EN62368-1:2014/A11:2017	Information Technology
CE	LVD	

Safety Agency	Safety Standard	Category
CB Report	Certificate #US/17857/UL, IEC60601-1 Ed 3 Including Risk Management	Medical
UL	UL File # E146893, ANSI/AAMI ES 60601-1:2005 & CSA C22.2 No. 60601-1:08	Medical
TUV	EN60601-1:2006	Medical

Means of Protection		Category
Primary to Secondary	2 x MOPP (Means of Patient Protection)	IEC60601-1 Ed 3
Primary to Earth	1 x MOPP (Means of Patient Protection)	
Secondary to Earth	1 x MOPP (Means of Patient Protection)	

Equipment Protection Class	Safety Standard	Notes & Conditions
Class I (& Class II, B Models)	IEC60950-1:2005 Ed 2 / IEC62368-1:2014 & IEC60601-1 Ed 3	See safety agency conditions of acceptability for details



## Mechanical Details

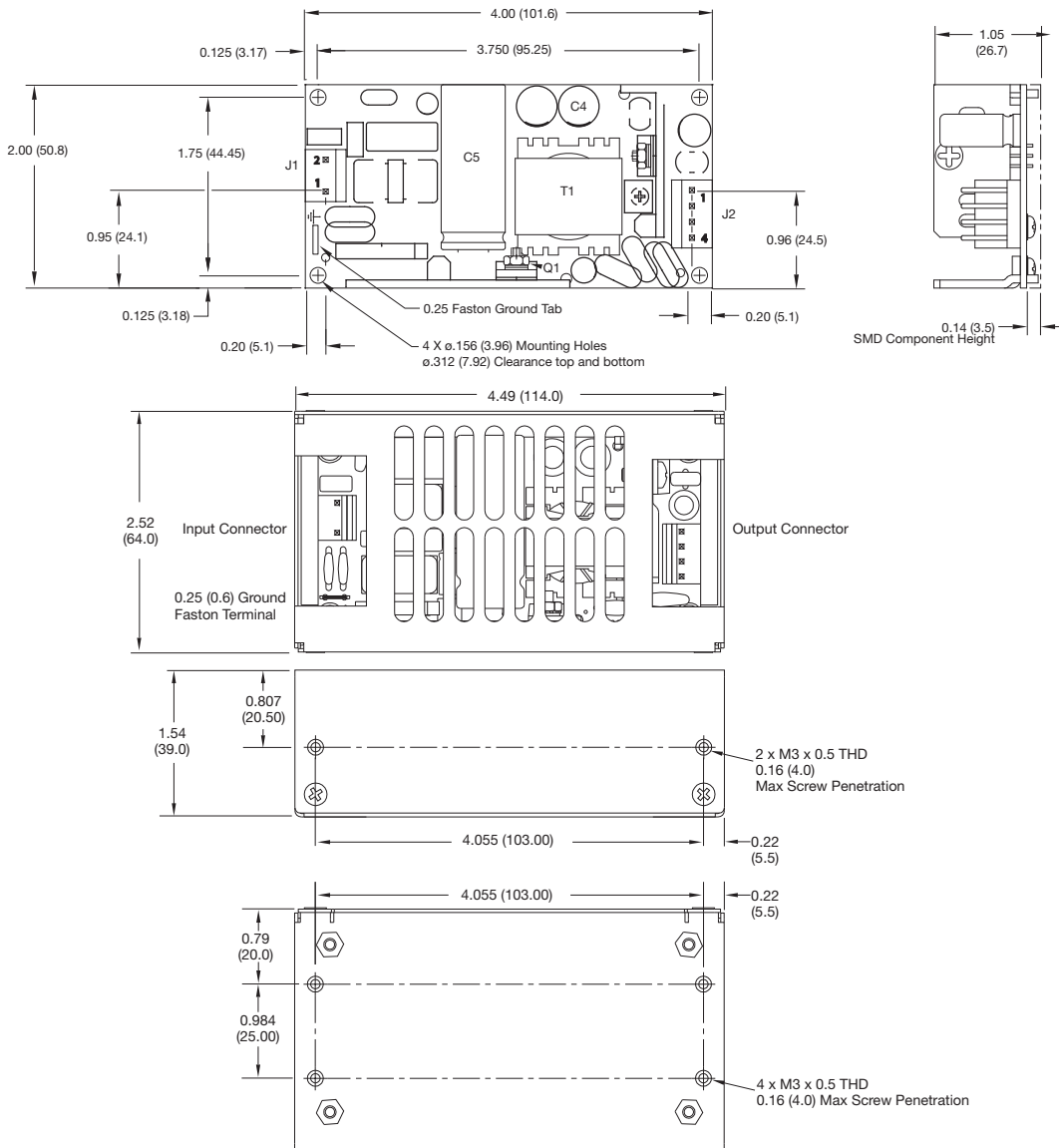

Input Connector J1 Molex PN 09-65-2038	
Pin 1	Line
Pin 2	Neutral
0.25" Faston	Earth

J1 mates with Molex Housing PN 09-50-1031, J2 mates with Molex Housing PN 09-50-1041 and both with Molex Series 5194 Crimp Terminals

Output Connector J2 Molex PN 09-65-2048	
Pin 1	+V1
Pin 2	+V1
Pin 3	RTN
Pin 4	RTN

### Notes

1. All dimensions in inches (mm).  
Tolerance .xx = ±0.02 (0.50); .xxx = ±0.01 (0.25)

2. Weight: 0.28 lbs (125 g) & with cover 0.66 lbs (300 g)

## Thermal Considerations

In order to ensure safe operation of the PSU in the most adverse conditions permitted in the end-use equipment, the temperature of the components listed in the table below must not be exceeded. See drawing on page 9 for component locations. Temperature should be monitored using K type thermocouples placed on the hottest part of the component (out of any direct air flow).

Temperature Measurements (Ambient ≤ 50 °C)	
Component	Max Temperature °C
T1	110 °C
C5	100 °C
C4	100 °C
Q1	110 °C

# ECS100 Series

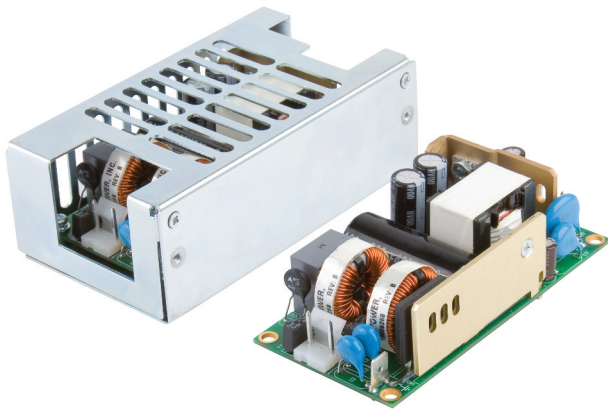

- IT & Medical Safety Approvals
- <0.5 W Standby Power
- High Power Density 10 W/in<sup>3</sup>
- 80/100 W Convection & Force-cooled Ratings
- Class I & Class II Installations
- Industry Standard 2.0" x 4.0" x 1.25" Format
- Class B Radiated Emissions ('-B' Models)
- Low Earth Leakage Current
- 3 Year Warranty

The ECS100 Series has been designed to minimise the no load power consumption (<0.5 W) and maximise efficiency in order to facilitate equipment design to the latest environmental legislation.

Approved for Class I and Class II applications, the ECS100 range of single output AC-DC, 100 W power supplies feature high power density in an industry standard 2 x 4" (51.0 mm x 102.0 mm) footprint. The 1.20" (31.0 mm) high, 1U compatible high-density power supplies meet EN55032 Level B emissions with low earth leakage currents of 100 µA at 115 VAC or 215 µA at 230 VAC. Making these switchers ideal for industrial, IT and medical applications.

The ECS100 series has single output versions from 12 V to 48 VDC, adjustable by ±10%. They are dual-fused for compliance with IEC60601-1 and efficiency is 88% typical, so minimal excess heat is generated. The ECS100 require only 10 CFM of cooling to delivers a full 100 W of power up to +50 °C and operates at up to +70 °C with derating or equally supply 80 W when convection-cooled up to +50 °C with operation to +70 °C with derating.

## Models and Ratings - Convection-cooled

Output Power		Output Voltage V1	Max Output Current	Model Number <sup>(1)</sup>
Forced Cooled (10 CFM)	Convection Cooled			
100 W	80 W	12.0 VDC	8.3 A	ECS100US12
100 W	80 W	15.0 VDC	6.7 A	ECS100US15
100 W	80 W	18.0 VDC	5.5 A	ECS100US18
100 W	80 W	24.0 VDC	4.2 A	ECS100US24
100 W	80 W	28.0 VDC	3.6 A	ECS100US28
100 W	80 W	48.0 VDC	2.1 A	ECS100US48

**Notes:**  
 1. For Class B radiated emissions models, add suffix -B to model number. For covered versions, add suffix '-C' to model number or order part no. ECM40/60 COVER for standalone cover. Derate output power by 20% with cover. The cover is not suitable for Class II installations.

## Input Characteristics

Characteristic	Minimum	Typical	Maximum	Units	Notes & Conditions
Input Voltage - Operating	80	115/230	264	VAC	Derate output power < 90 VAC. See fig. 1
Input Frequency	47	50/60	400	Hz	Agency approval 47-63 Hz
Power Factor		>0.5			230 VAC, 100% load EN61000-3-2 class A compliant
Input Current - No Load		0.02/0.04		A	115/230 VAC
Input Current - Full Load		1.5/0.9		A	115/230 VAC
Inrush Current			40	A	230 VAC cold start, 25 °C
No Load Input Power		0.3/0.4	0.5	W	115/230 VAC
Earth Leakage Current		100/215	230	µA	115/230 VAC/50 Hz (Typ.), 264 VAC/60 Hz (Max.)
		0.5/1.1		mA	115/230 VAC/400 Hz
Input Protection	T3.15A/250 V internal fuse in both line and neutral				

## Output Characteristics

Characteristic	Minimum	Typical	Maximum	Units	Notes & Conditions
Output Voltage - V1	12		48	VDC	See Models and Ratings table
Initial Set Accuracy			±1	%	50% load, 115/230 VAC
Output Voltage Adjustment	±10			%	Via potentiometer. See mech. details (page 9)
Minimum Load	0			A	
Start Up Delay		1		s	230 VAC full load (see fig.2)
Hold Up Time	16			ms	115 VAC full load (see fig.3)
Drift			±0.2	%	After 20 min warm up
Line Regulation			±0.5	%	90-264 VAC
Load Regulation			±1	%	0-100% load.
Transient Response - V1			4	%	Recovery within 1% in less than 500 µs for a 50-75% and 75-50% load step
Over/Undershoot - V1		5		%	See fig.4
Ripple & Noise			1	% pk-pk	20 MHz bandwidth (see fig.5 & 6)
Overvoltage Protection	115		140	%	Vnom DC.
Overload Protection	110		150	% I nom	Auto reset (see fig.7)
Short Circuit Protection					Continuous, trip & restart (hiccup mode)
Temperature Coefficient			0.05	%/°C	
Overtemperature Protection				°C	Not fitted

## Input Voltage Derating

Figure 1

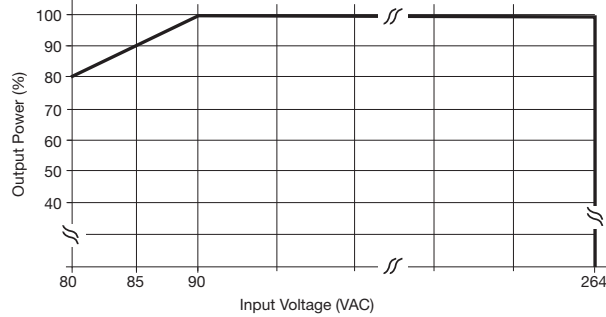

## Start Up Delay From AC Turn On

Figure 2  
Start up example from AC turn on  
(230 VAC, 720 ms)

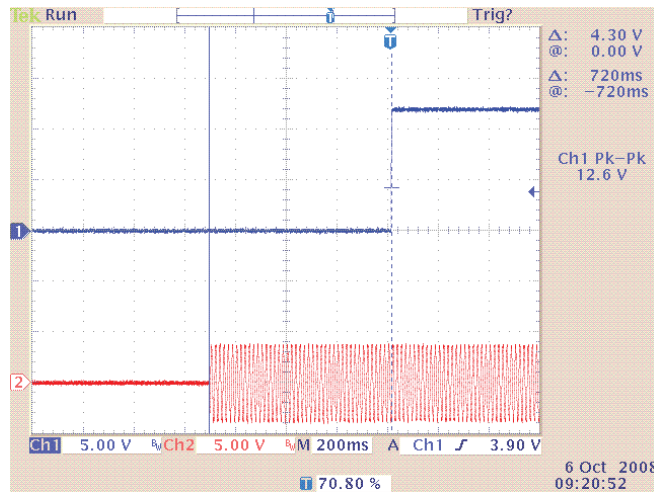

## Hold Up Time From Loss of AC

Figure 3  
Hold up example at 100 W load  
with 115 VAC input (17.2ms)

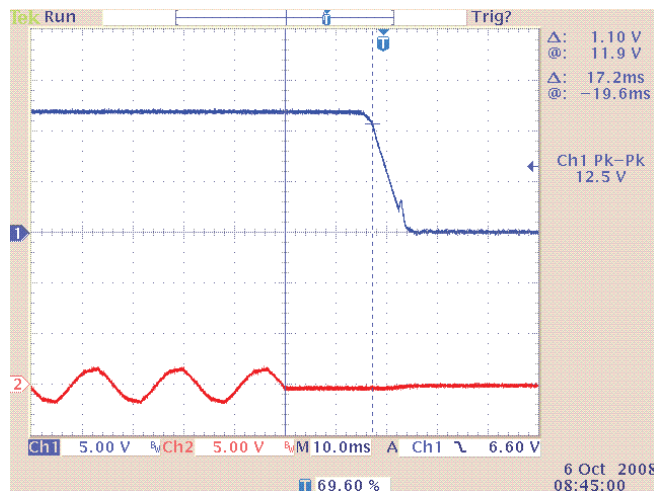

### Typical Output Overshoot

Figure 4  
Typical Output Overshoot  
(ECS100US12, 230 VAC)

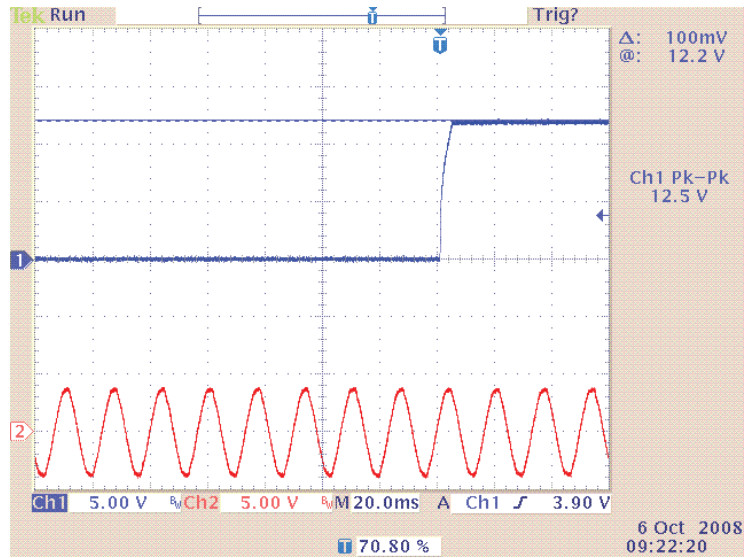

### Output Ripple & Noise

Figure 5  
ECS100US12 (100 W)  
66 mV pk-pk ripple. 20 MHz BW

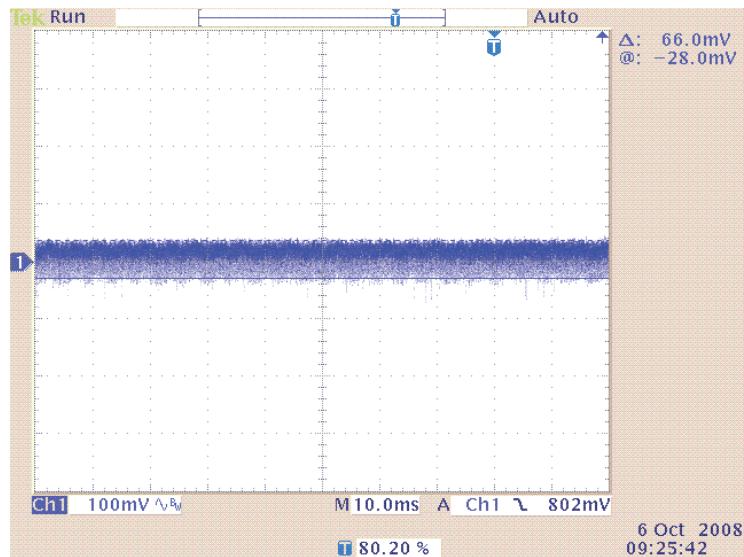

## Output Ripple & Noise cont.

Figure 6  
ECS100US24 (100 W)  
58 mV pk-pk ripple. 20 MHz BW

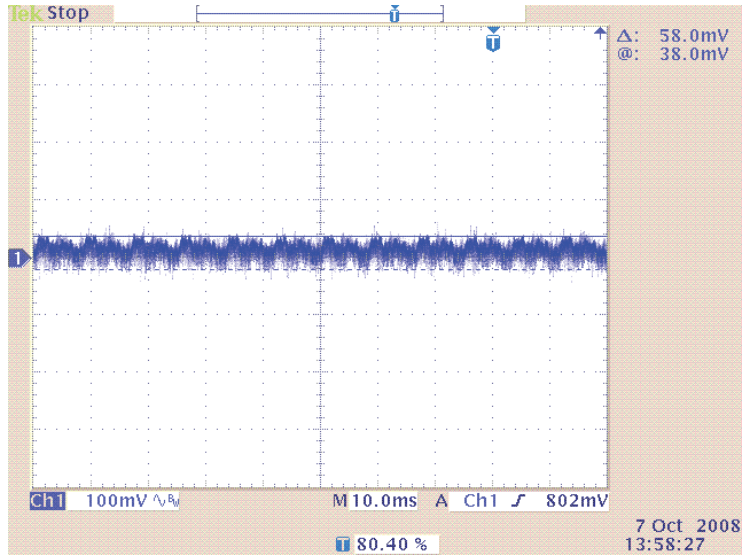

## Output Overload Characteristic

Figure 7  
Typical Overload  
Characteristic  
(ECS100US12 shown)

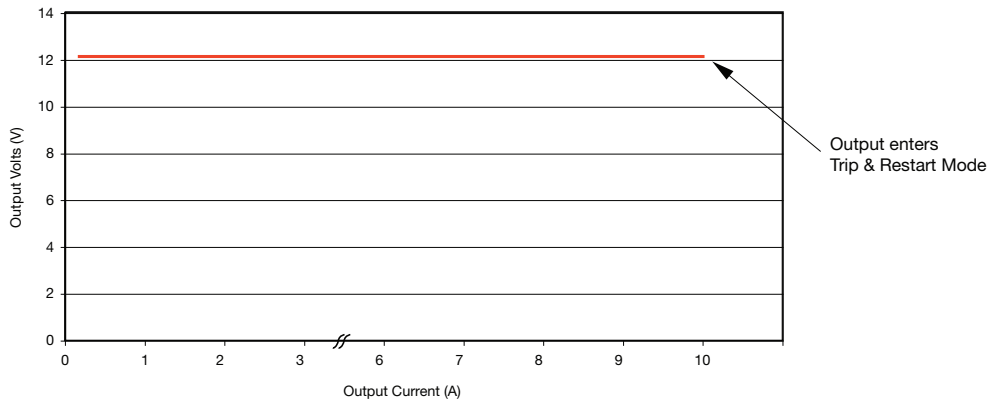

## General Specifications

Characteristic	Minimum	Typical	Maximum	Units	Notes & Conditions
Efficiency		88		%	Full load (see fig.8 & 9)
Isolation: Input to Output Input to Ground Output to Ground	4000			VAC	
	1500			VAC	
	500			VDC	
Switching Frequency		65		kHz	
Power Density			10	W/in <sup>3</sup>	
Mean Time Between Failure		834		kHrs	MIL-HDBK-217F, Notice 2 +25 °C GB
		1245			Telecordia SR-332 +25 °C
Weight			0.4 (175)	lb (g)	

## Efficiency Versus Load

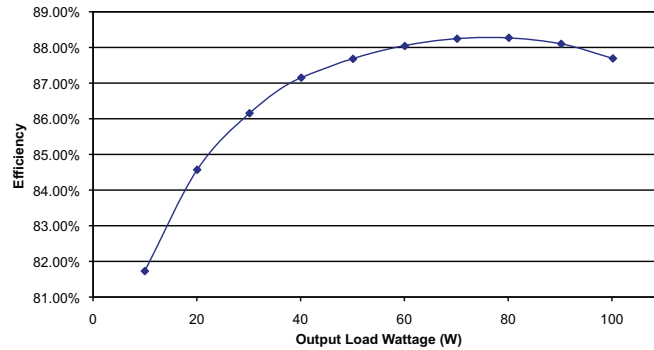

Figure 8  
ECS100US12 at 230 VAC

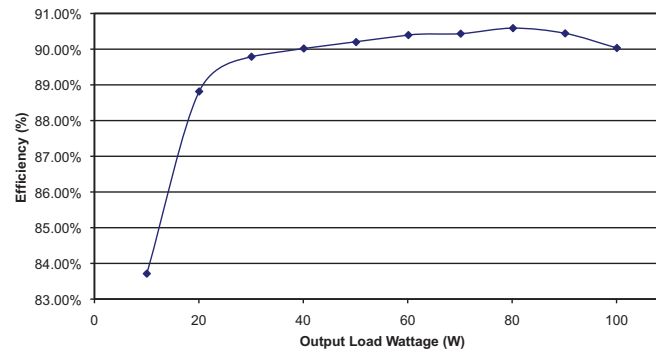

Figure 9  
ECS100US24 at 230 VAC

## Environmental

Characteristic	Minimum	Typical	Maximum	Units	Notes & Conditions
Operating Temperature	-20		+70	°C	Derate linearly from +50 °C at 2.5%/°C to 50% at 70 °C. (See fig.10 & Thermal Considerations)
Storage Temperature	-40		+85	°C	
Cooling	10			CFM	>80 W output power. See fig.10 & Thermal Considerations
Humidity	5		95	%RH	Non-condensing
Operating Altitude			3000	m	
Shock					3 x 30 g/11 ms shocks in both +ve & -ve directions along the 3 orthogonal axis, total 18 shocks.
Vibration					Three axis 5-500 Hz at 2 g x 10 sweeps

## Derating Curve

Figure 10

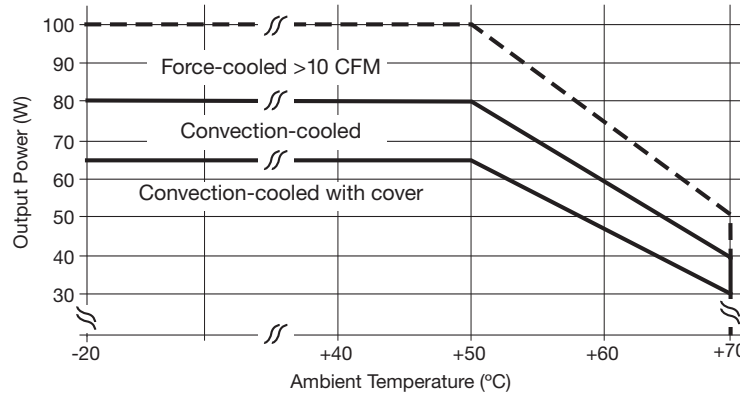

## Electromagnetic Compatibility - Immunity

Phenomenon	Standard	Test Level	Criteria	Notes & Conditions
Low Voltage PSU EMC	EN61204-3	High severity level	as below	
Harmonic Current	EN61000-3-2	Class A		
ESD Immunity	EN61000-4-2	±6 kV Contact ±15 kV Air Discharge	A	
Radiated	EN61000-4-3	3	A	
EFT	EN61000-4-4	3	A	
Surges	EN61000-4-5	Installation class 3	A	
Conducted	EN61000-4-6	3	A	
Dips and Interruptions	EN61000-4-11	Dip: 30% 10 ms	A	
		Dip: 60% 100 ms	B	
		Dip: 100% 5000 ms	B	
	EN60601-1-2	Dip: 30% 500 ms	A	
		Dip: 60% 100 ms	A	Load derating with 115 VAC input (typically 50% derate dependant on model & load)
		Dip: 100% 10 ms	A	
		Int.: >95% 5000 ms	B	



## Electromagnetic Compatibility - Emissions

Phenomenon	Standard	Test Level	Criteria	Notes & Conditions
Conducted	EN55011/32	Class B		See fig. 11
Radiated	EN55011/32	Class A		
		Class B		ECS100-B Models
Voltage Fluctuations	EN61000-3-3			

### Typical EMC Plot

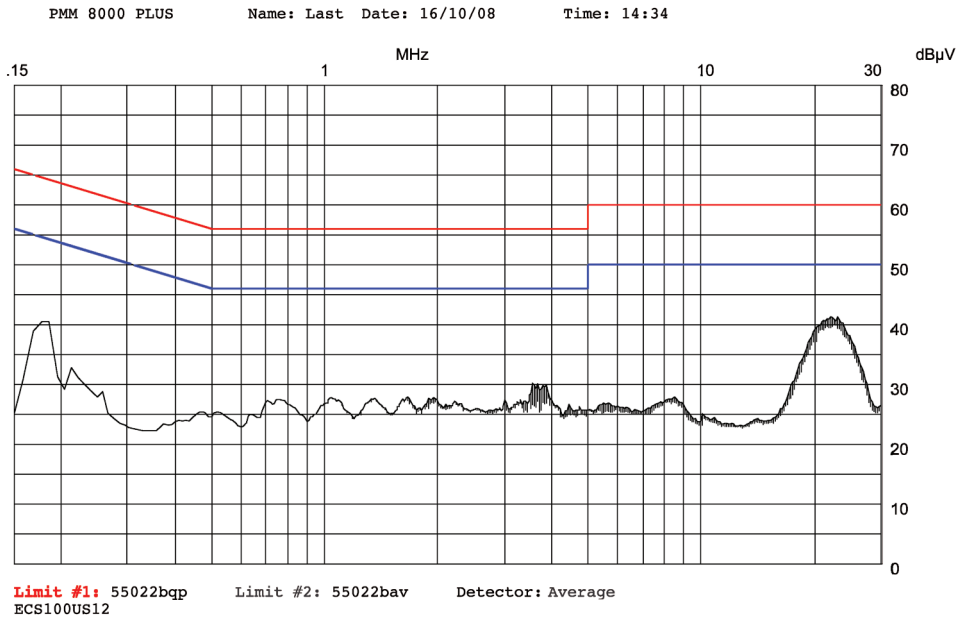

Figure 11  
Typical conducted noise plot (Class I)

### Safety Agency Approvals

Safety Agency	Safety Standard	Category
CB Report	IEC60950-1:2005 Ed 2 / IEC62368-1:2014	Information Technology
UL	UL 62368-1 & CAN/CSA C22.2 No. 62368-1-14	Information Technology
TUV	EN62368-1:2014/A11:2017	Information Technology
CE	LVD	

Safety Agency	Safety Standard	Category
CB Report	IEC60601-1 Ed 3 Including Risk Management	Medical
UL	UL File # E146893, ANSI/AAMI ES 60601-1:2005 & CSA C22.2 No. 60601-1:08	Medical
TUV	EN60601-1:2006	Medical

Means of Protection		Category
Primary to Secondary	2 x MOPP (Means of Patient Protection)	IEC60601-1 Ed 3
Primary to Earth	1 x MOPP (Means of Patient Protection)	
Secondary to Earth	1 x MOPP (Means of Patient Protection)	

Equipment Protection Class	Safety Standard	Notes & Conditions
Class I & Class II	IEC60950-1:2005 Ed 2 / IEC62368-1:2014 & IEC60601-1 Ed 3	See safety agency conditions of acceptability for details

## Mechanical Details

### Open Frame Versions

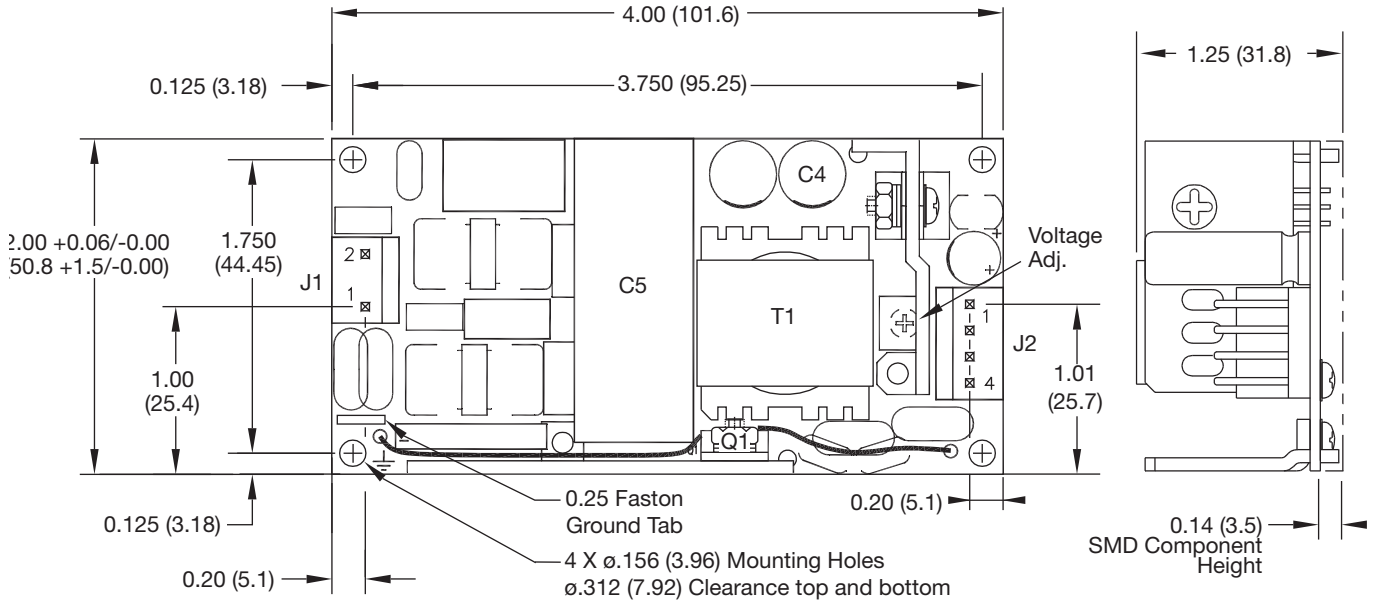

### -B' Model

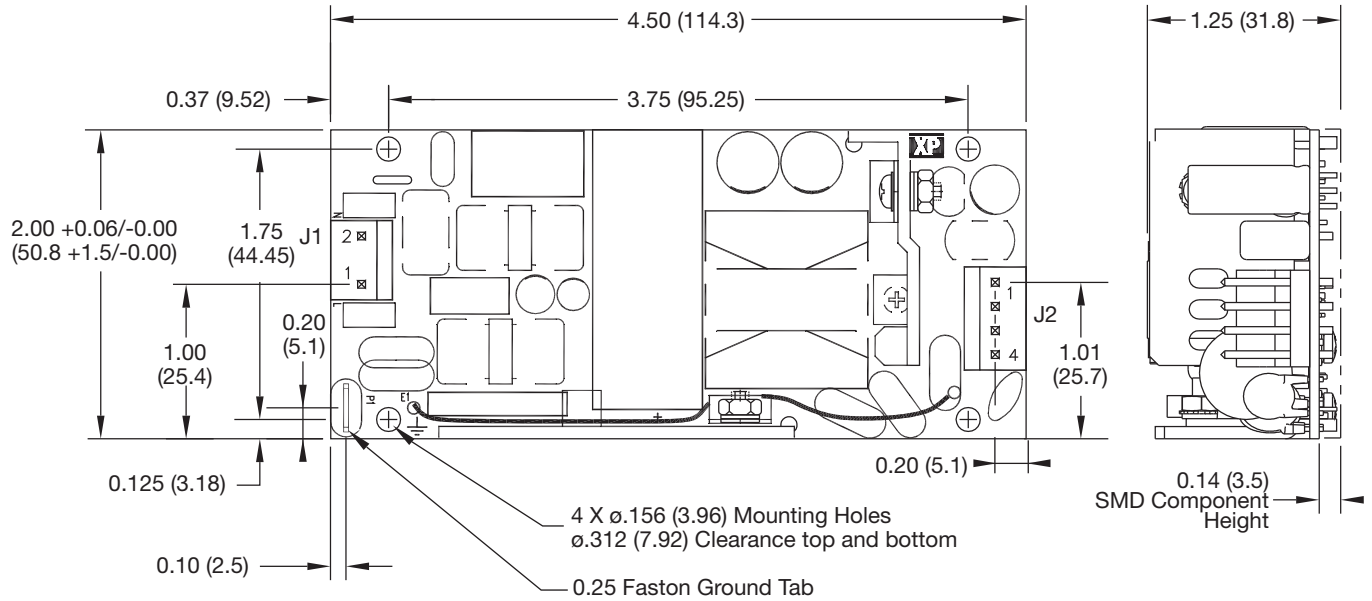

Input Connector J1 Molex PN 09-65-2038	
Pin 1	Line
Pin 2	Neutral
0.25" Faston	Earth

J1 mates with Molex Housing PN 09-50-1031, J2 mates with Molex Housing PN 09-50-1041 and both with Molex Series 5194 Crimp Terminals

Output Connector J2 Molex PN 09-65-2048	
Pin 1	+V1
Pin 2	+V1
Pin 3	RTN
Pin 4	RTN

### Notes

1. All dimensions in inches (mm).

Tolerance .xx = ±0.02 (0.50); .xxx = ±0.01 (0.25)

2. Weight: 0.4 lbs (175 g) (Open Frame)

**Covered Versions -C (not available for -B models)**

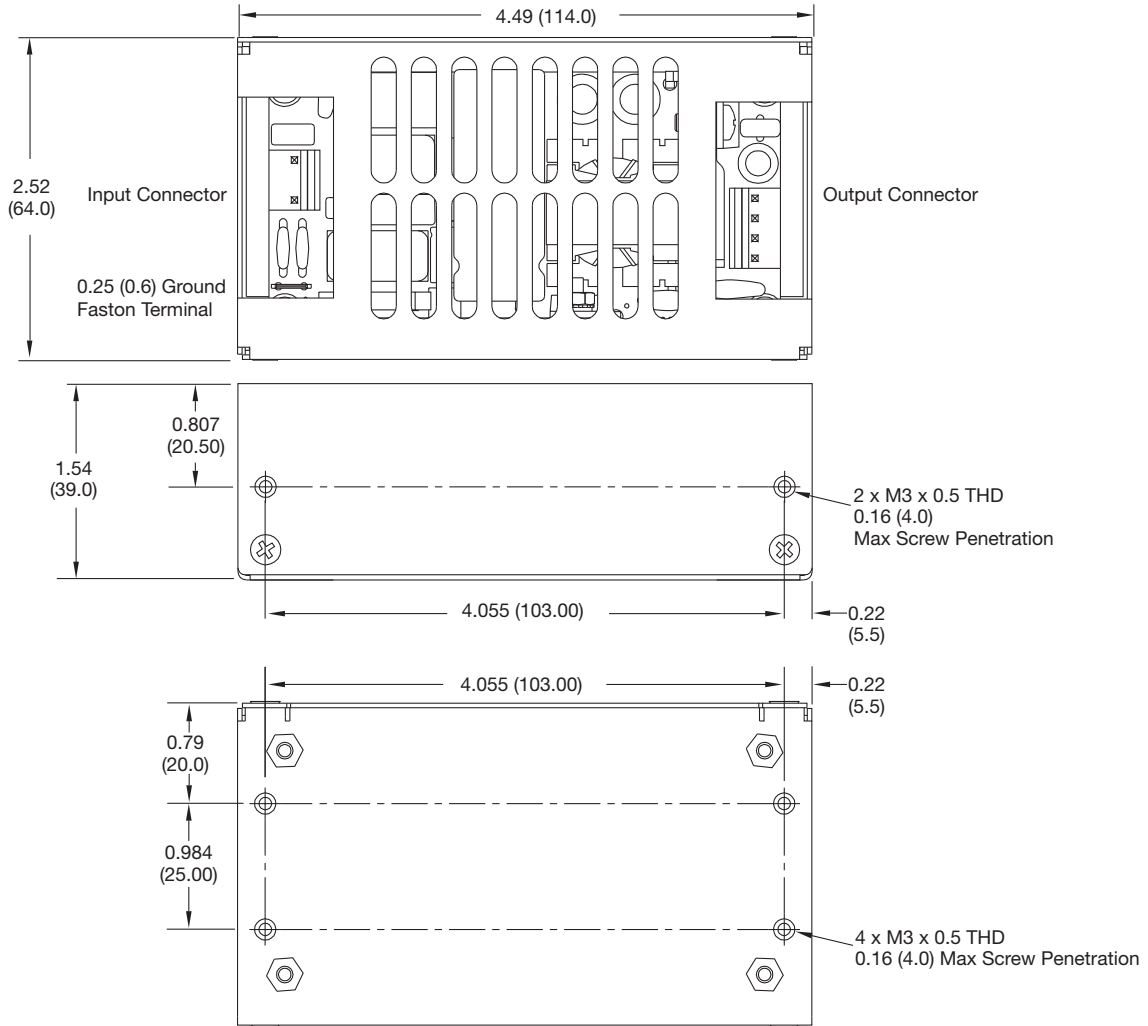

Input Connector J1 Molex PN 09-65-2038	
Pin 1	Line
Pin 2	Neutral
0.25" Faston	Earth

J1 mates with Molex Housing PN 09-50-1031,  
J2 mates with Molex Housing PN 09-50-1041 and both with Molex Series 5194 Crimp Terminals

Output Connector J2 Molex PN 09-65-2048	
Pin 1	+V1
Pin 2	+V1
Pin 3	RTN
Pin 4	RTN

**Notes**

- All dimensions in inches (mm).  
Tolerance .xx = ±0.02 (0.50); .xxx = ±0.01 (0.25)
- Weight: 0.4 lbs (175 g) (Open Frame)

**Thermal Considerations**

In order to ensure safe operation of the PSU in the most adverse conditions permitted in the end-use equipment, the temperature of the components listed in the table below must not be exceeded. See drawing on page 9 for component locations. Temperature should be monitored using K type thermocouples placed on the hottest part of the component (out of any direct air flow).

Temperature Measurements (Ambient ≤ 50 °C)	
Component	Max Temperature °C
T1	110 °C
C5	100 °C
C4	100 °C
Q1	110 °C

# ECS130 Series

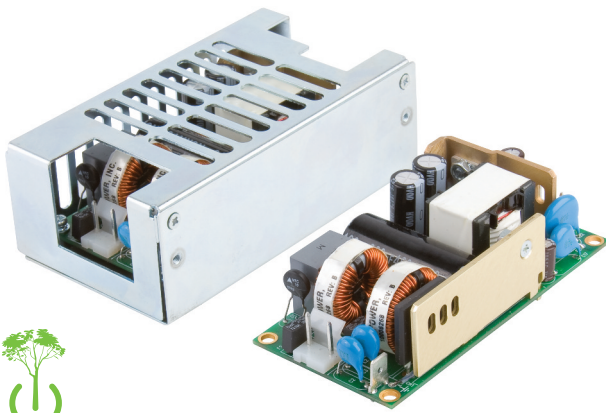

- IT & Medical Safety Approvals
- Industry Standard 2.0" x 4.0 x 1.25" Format
- < 0.5W Standby Power
- Convection & Forced Cooled Ratings
- -40° C to +70° C Operation
- Class I & Class II Installations
- Low Earth Leakage Current
- Class B Emissions
- 3 Year Warranty

The ECS130 Series has been designed to minimise the no load power consumption (<0.5 W) and maximise efficiency in order to facilitate equipment design to the latest environmental legislation.

Approved for Class I and Class II applications, the ECS130 range of single output AC-DC, 130 W power supplies feature high power density in an industry standard 2" x 4" (51.0 mm x 102.0 mm) footprint. The 1.25" (31.8 mm) high, 1U compatible high-density power supplies meet EN55032 Level B emissions with low earth leakage currents of 100  $\mu$ A at 115 VAC or 215  $\mu$ A at 230 VAC. Making these switchers ideal for industrial, IT and medical applications.

The ECS130 series has single output versions from 12 V to 48 VDC, adjustable by  $\pm 10\%$ . They are dual-fused for compliance with IEC60601-1 and efficiency is 88% typical, so minimal excess heat is generated. The ECS130 require only 10 CFM of cooling to delivers a full 130 W of power up to +50 °C and operates at up to +70 °C with derating or equally can supply 100 W when convection cooled up to +50 °C with operation to +70 °C with derating.

## Models and Ratings

Output Power		Output Voltage	Output Current	Model Number <sup>(1)</sup>
Forced Cooled (10 CFM)	Convection-cooled			
130 W	100 W	12.0 VDC	10.9 A	ECS130US12†^
130 W	100 W	15.0 VDC	8.7 A	ECS130US15†^
130 W	100 W	18.0 VDC	7.3 A	ECS130US18
130 W	100 W	24.0 VDC	5.4 A	ECS130US24†^
130 W	100 W	28.0 VDC	4.7 A	ECS130US28†^
130 W	100 W	48.0 VDC	2.7 A	ECS130US48†^

1. For covered versions, add suffix '-C' to model number or order part no. ECM40/60 COVER for standalone cover, see derating curve. The cover is not suitable for Class II installations. '-C'.

## Input Characteristics

Characteristic	Minimum	Typical	Maximum	Units	Notes & Conditions
Input Voltage - Operating	80	115/230	264	VAC	See derating curve. See fig 1.
Input Frequency	47	50/60	63	Hz	
Power Factor		>0.5			230 VAC, 100% load EN61000-3-2 Class A Compliant.
Input Current - No Load		0.03		A	
Input Current - Full Load		1.9/1.1		A	115/230 VAC
Inrush Current			40	A	230 VAC cold start 25 °C
No Load Input Power			0.5	W	
Earth Leakage Current			260	µA	264 VAC/60 Hz (Max.)
Input Protection	T3.15 A/250 V internal fuse in both lines				

## Output Characteristics

Characteristic	Minimum	Typical	Maximum	Units	Notes & Conditions
Output Voltage - V1	12		48	VDC	See Models and Ratings table
Initial Set Accuracy			±1	%	50% load, 115/230 VAC
Output Voltage Adjustment -V1	±10			%	Via potentiometer. See mech. details,
Minimum Load	0			A	
Start Up Delay		1		s	115/230 VAC full load
Hold Up Time		18		ms	
Drift			±0.2	%	After 20 min warm up
Line Regulation			±0.5	%	90-264 VAC
Load Regulation				%	0-100% load
Transient Response - V1			4	%	Recovery within 1% in less than 500 µs for a 50-75% and 75-50% load step
Over/Undershoot - V1		5		%	
Ripple & Noise - V1			1	% pk-pk	20 MHz bandwidth, 12V Models 1.5% max
Overvoltage Protection - V1	115		140	%	Vnom DC. Output 1, recycle input to reset
Overload Protection - V1	110		160	% I nom	See fig. 2. Trip and Restart
Short Circuit Protection - V1					Continuous
Temperature Coefficient			0.05	%/°C	
Overtemperature Protection				°C	Not fitted

## Input Voltage Derating Curve

Figure 1

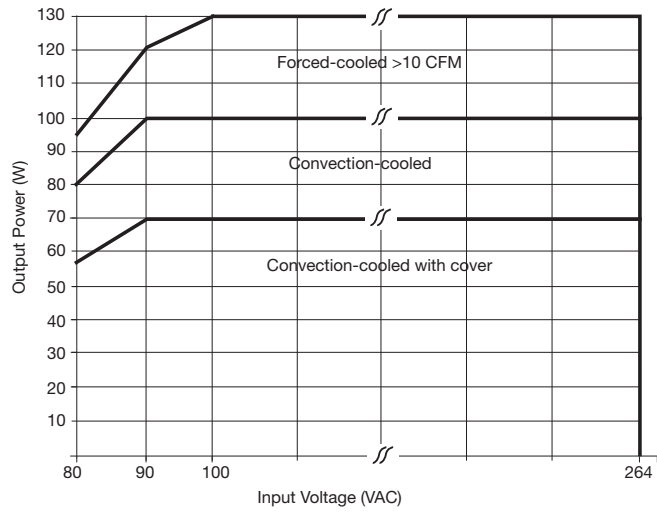

## Output Overload Characteristic

Figure 2  
12V Models

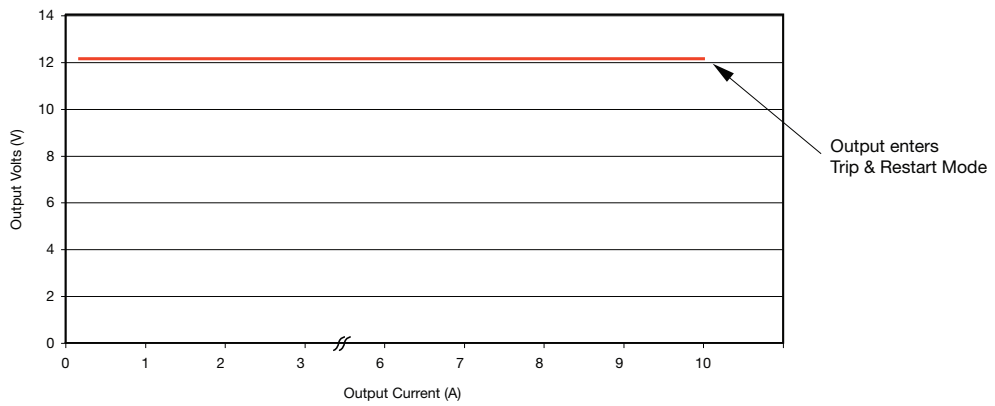

## General Specifications

Characteristic	Minimum	Typical	Maximum	Units	Notes & Conditions
Efficiency		88		%	230 VAC Full load (see fig.3-5)
Isolation: Input to Output Input to Ground Output to Ground	4000			VAC	
	1500			VAC	
	500			VDC	
Switching Frequency		65		kHz	
Power Density			13	W/in <sup>3</sup>	
Mean Time Between Failure		715		kHrs	MIL-HDBK-217F, Notice 2 +25 °C GB
Weight: Open Frame Covered Unit		0.40 (0.18)		lb (kg)	
		0.80 (0.36)		lb (kg)	

## Efficiency Versus Load

Figure 3 - 12V Models

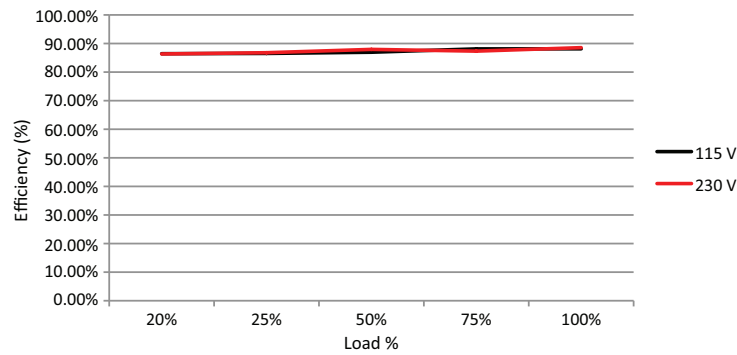

Figure 4 - 24V Models

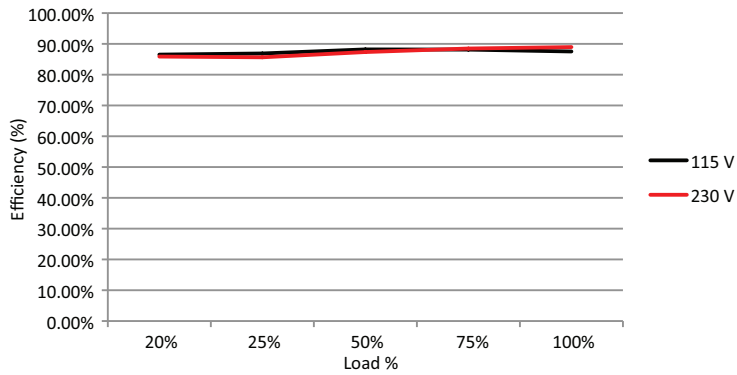
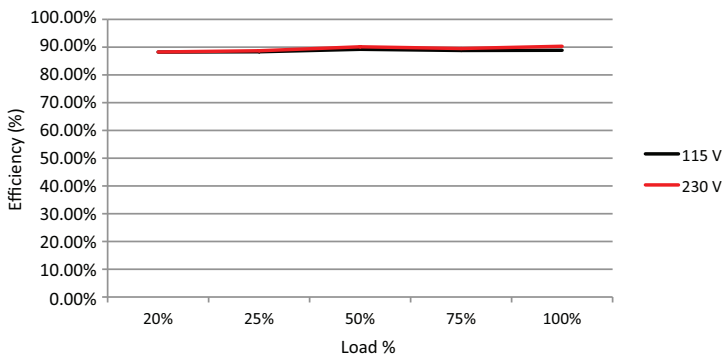

Figure 5 - 48V Models



## Environmental

Characteristic	Minimum	Typical	Maximum	Units	Notes & Conditions
Operating Temperature	-40		+70	°C	See derating curve, fig. 6
Storage Temperature	-40		+85	°C	
Cooling	10			CFM	Forced Cooled >100 W
Humidity	5		95	%RH	Non-condensing
Operating Altitude			5000	m	
Shock					±3 x 30g shocks in each plane, total 18 shocks. 30g = 11ms (+/-0.5msec), half sine. Conforms to EN60068-2-27 & EN60068-2-47
Vibration					Single axis 10 - 500 Hz at 2g sweep and endurance at resonance in all 3 planes. Conforms to EN60068-2-6

## Thermal Derating Curve

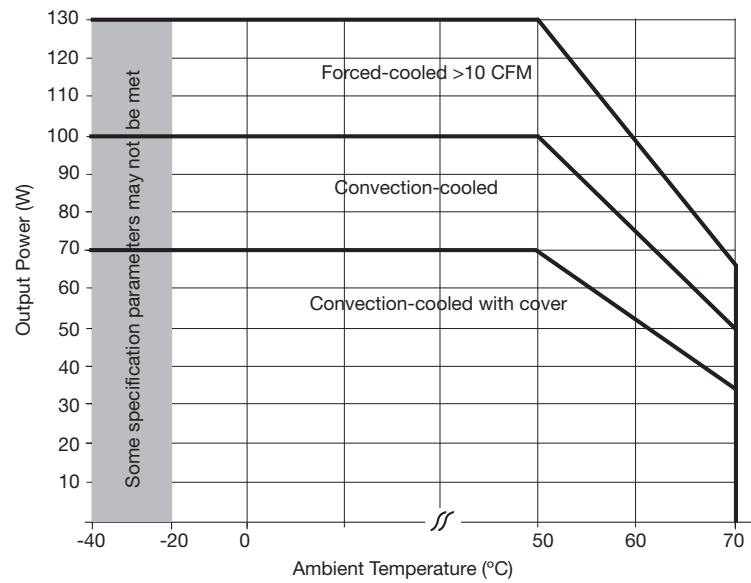

Figure 6



## Electromagnetic Compatibility - Emissions

Phenomenon	Standard	Test Level	Criteria	Notes & Conditions
Conducted	EN55011/32	Class B		
Radiated	EN55011/32	Class A		
Voltage Fluctuations	EN61000-3-3			

## Electromagnetic Compatibility - Immunity

Phenomenon	Standard	Test Level	Criteria	Notes & Conditions	
Low Voltage PSU EMC	EN61204-3	High severity level	as below		
Harmonic Current	EN61000-3-2	Class A			
ESD Immunity	EN61000-4-2	±6 kV Contact ±15 kV Air Discharge	A		
Radiated	EN61000-4-3	3	A		
EFT	EN61000-4-4	3	A		
Surges	EN61000-4-5	Installation class 3	A		
Conducted	EN61000-4-6	3	A		
Dips and Interruptions	EN55024 (100 VAC)	Dip >95% (0 VAC), 8.3ms	B		
		Dip 30% (70 VAC), 416ms	B		
		Dip >95% (0 VAC), 4160ms	B		
	EN55024 (240 VAC)	Dip >95% (0 VAC), 10.0ms	B		
		Dip 30% (168 VAC), 500ms	B		
		Dip >95% (0 VAC), 5000ms	B		
	EN60601-1-2 (100 VAC)	Dip >95% (0 VAC), 10.0ms	A		Derate Output Power to 100 W
		Dip 60% (40 VAC), 100ms	A		Derate Output Power to 12 W
		Dip 30% (70 VAC), 500ms	A		Derate Output Power to 100 W
		Dip >95% (0 VAC), 5000ms	B		
	EN60601-1-2 (240 VAC)	Dip >95% (0 VAC), 10.0ms	A		
		Dip 60% (96 VAC), 100ms	A		
Dip 30% (168 VAC), 500ms		A			
Dip >95% (0 VAC), 5000ms		B			

## Safety Agency Approvals

Safety Agency	Safety Standard	Category
CB Report	IEC60950-1:2005 Ed 2 / IEC62368-1:2014	Information Technology
UL	UL 62368-1 & CAN/CSA C22.2 No. 62368-1-14	Information Technology
TUV	EN62368-1:2014/A11:2017	Information Technology
CE	LVD	

Safety Agency	Safety Standard	Category
CB Report	IEC60601-1 Ed 3 Including Risk Management	Medical
UL	ANSI/AAMI ES60601-1:2005 & CSA C22.2, No.60601-1:08	Medical
TUV	EN60601-1/A12:2006	Medical

Means of Protection		Category
Primary to Secondary	2 x MOPP (Means of Patient Protection)	IEC60601-1 Ed 3
Primary to Earth	1 x MOPP (Means of Patient Protection)	
Secondary to Earth	1 x MOPP (Means of Patient Protection)	

Equipment Protection Class	Safety Standard	Notes & Conditions
Class I & Class II	IEC60950-1:2005 Ed 2 / IEC62368-1:2014 & IEC60601-1 Ed 2	See safety agency conditions of acceptability for details

## Mechanical Details

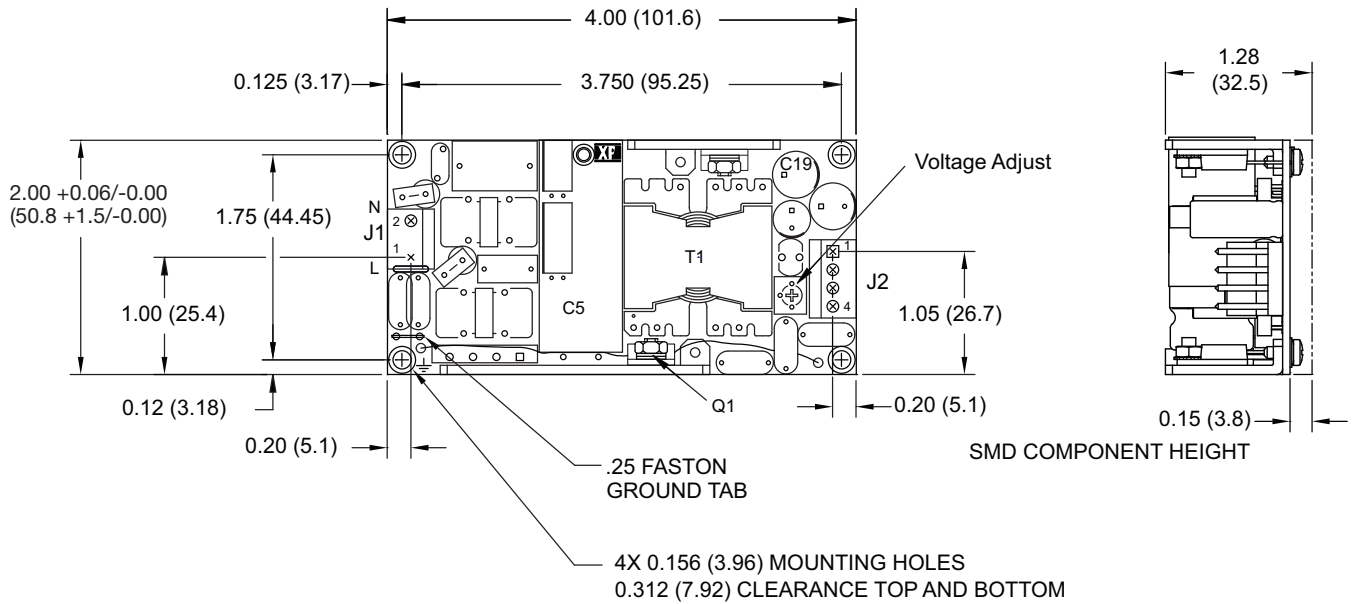

Input Connector J1 Molex PN 09-65-2038	
Pin 1	Line
Pin 2	Neutral
0.25" Faston	Earth

Output Connector J2 Molex PN 09-65-2048	
Pin 1	+V1
Pin 2	+V1
Pin 3	RTN
Pin 4	RTN

J1 mates with Molex Housing PN 09-50-1031, J2 mates with Molex Housing PN 09-50-1041 and both with Molex Series 5194 Crimp Terminals

### Notes

- All dimensions in inches (mm).  
Tolerance .xx = ±0.02 (0.50); .xxx = ±0.01 (0.25)
- Weight: 0.386 lbs (175 g)

## Mechanical Details - Covered (-C)

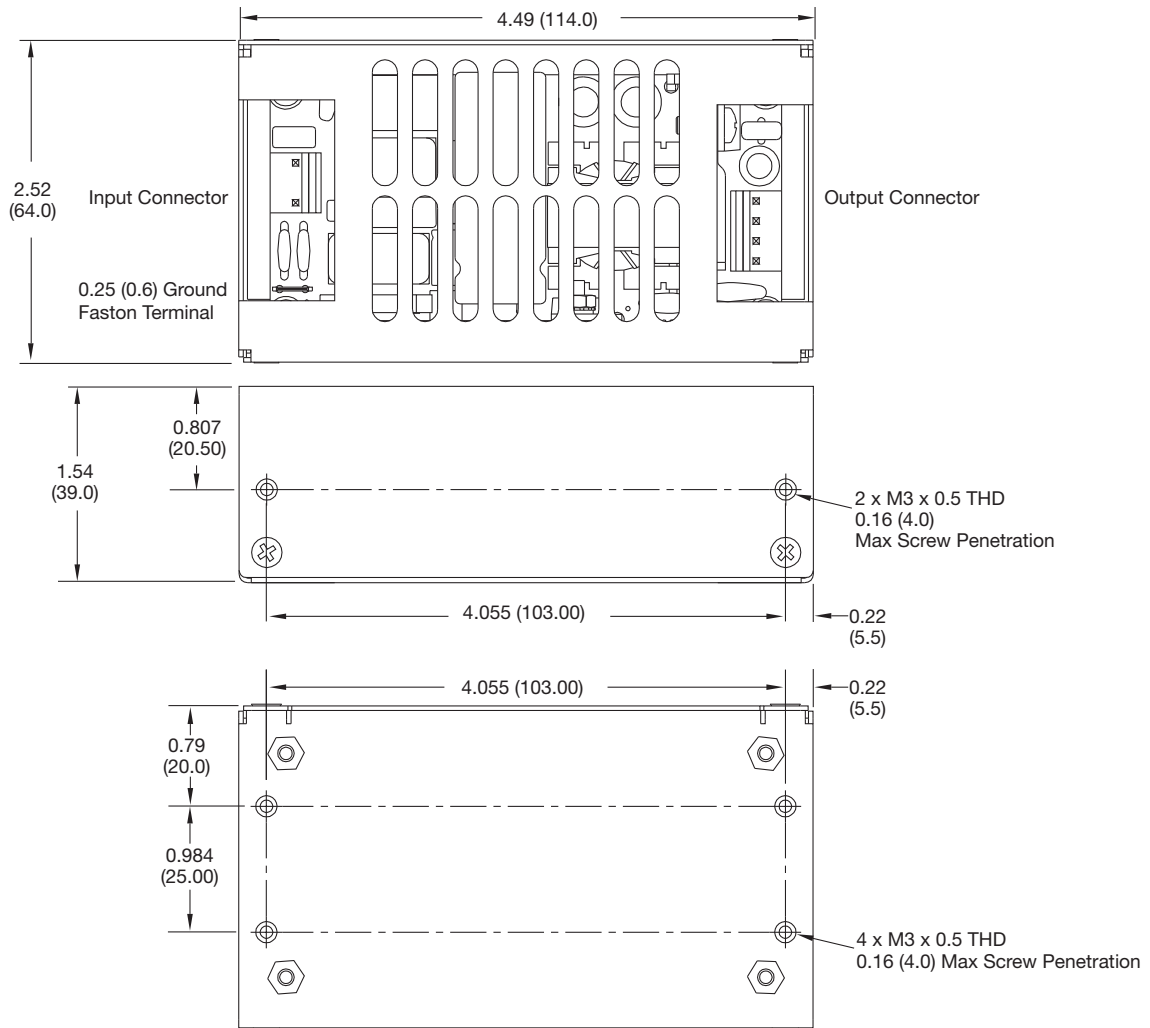

### Notes

1. All dimensions in inches (mm).  
Tolerance .xx =  $\pm 0.02$  (0.50); .xxx =  $\pm 0.01$  (0.25)

2. Weight: 0.8 lbs (360 g)

## Thermal Considerations

In order to ensure safe operation of the PSU in the end-use equipment, the temperature of the components listed in the table below must not be exceeded. Temperature should be monitored using K type thermocouples placed on the hottest part of the component (out of any direct air flow). See Mechanical Details for component locations.

Temperature Measurements (Ambient 50 °C)	
Component	Max Temperature °C
T1 Coil	120 °C
Q1 Body	120 °C
C5	105 °C
C4	105 °C

## Service Life

The estimated service life of the ECS130 Series is determined by the cooling arrangements and load conditions experienced in the end application. Due to the uncertain nature of the end application this estimated service life is based on the actual measured temperature of a key capacitor within the product when installed in the end application. In order to ensure safe operation of the PSU in the most adverse conditions permitted in the end-use equipment, the temperature of the components listed in the table below must not be exceeded.

The graph below expresses the estimated lifetime for a given component temperature and assumes continuous operation at this temperature.

## Estimated Service Life vs Component Temperature

