

TO: PREMIER FARNELL UK LTD

Issue No. : A-M-EM-59

Date of Issue : Nov 23, 2012

Classification : New, Changed

PRODUCT SPECIFICATION FOR APPROVAL

Product Description : Aluminum Electrolytic Capacitor
Customer Part Number :

Product Part Number : ECA1EM470

Country of Origin : Japan, Malaysia (Printed on the packaging label)
Applications : It has the intention of being used for a general electronic circuit given in the notice matter (limitation of a use).
On the occasion of application other than the above, even person in charge of our company needs to inform in advance.

※ If you approve this specification, please fill in and sign the below and return 1copy to us.

Approval No	:	
Approval Date	:	
Executed by	:	_____
		(signature)
Title	:	
Dept.	:	

Capacitor Business Unit
Industrial Devices Company
Panasonic Corporation

25.Kohata-nishinaka, Uji City,
Kyoto, 611-8585, Japan
Phone :+81-774-32-1111

Phone :+81-774-33-3209(Direct)
Fax :+81-774-32-3189

Prepared by : Engineering Team 4
Engineering Group
Aluminum Capacitor Division

Contact Person
Signature _____
Name(Print) : Haruhiko Handa
Title : Engineer

Checked by
Signature _____
Name(Print) : Hisao Nagara
Title : Manager

Authorized by
Signature _____
Name(Print) : Hiroshi Kurimoto
Title : General Manager of Engineering

No. 4694513

Panasonic

Product Specification	A-M-EM-59
	Page No. Contents

Contents

Notice matter	P.1
Scope	P.2
Parts Number	P.2
Parts Lists	P.2
Dimensions and Appearance	P.3
Constructions	P.4
Marking	P.4
Lot No. System	P.5 ~ P.6
Standard Rating	P.7
Performance Characteristics	P.8 ~ P.11
Other Characteristics	P.12
Taping Shape and Dimensions	P.13
Application Guidelines	Guidelines-1 ~ 4

Product Specification	A-M-EM-59
	1

Notice matter

◆ Law and regulation which are applied

- This product complies with the RoHS Directive (Restriction of the use of certain Hazardous Substances in electrical and electronic equipment (DIRECTIVE 2002/95/EC).
- No Ozone Depleting Chemicals(ODC's), controlled under the Montreal Protocol Agreement, are used in producing this product.
- We do not PBBs or PBDEs as brominated flame retardants.
- All the materials that are used for this product are registered as "Known Chemicals" in the Japanese act "Law Concerning the Examination and Regulation of Manufacture, etc. of Chemical Substances".
- Export procedure which followed export related regulations, such as foreign exchange and a foreign trade method, on the occasion of export of this product Thank you for your consideration.

◆ Usage limitation

- This capacitor is designed to be used for electronics circuits such as audio/visual equipment, home appliances, computers and other office equipment, optical equipment and measuring equipment. High reliability and safety are required [be / a possibility that incorrect operation of this product may do harm to a human life or property] more. When use is considered by the use, the delivery specifications which suited the use separately need to be exchanged.

◆ Unless otherwise specified, the product shall conform to JIS 5101-4-1

◆ Country of origin : JAPAN, MALAYSIA

◆ Manufacturing factory : Aluminum Capacitor Division, Capacitor Business Unit,
Industrial Devices Company, Panasonic Corporation.
1285, Sakutaguchi, Asada, Yamaguchi City, Yamaguchi
753-8536 Japan

Panasonic Industrial Devices Malaysia Sdn.Bhd.
No.1 Jalan Jemuju 16/13,40200 Shah Alam,Selangor Darul Ehsan, MALAYSIA

Product Specification	A-M-EM-59
	2

1. Scope

Fixed capacitors for use in electronic equipment, Aluminum electrolytic capacitors with non-solid electrolyte.

2. Parts Number

<u>EC</u>	<u>A</u>	<u>1E</u>	<u>M</u>	<u>470</u>	<u>□</u>
2-1	2-2	2-3	2-4	2-5	2-6

2-1 Aluminum Electrolytic Capacitor

2-2 Type : Radial lead type (JIS : 04 type)

2-3 Rated Voltage Code

Voltage Code	1E
Rated Voltage (V.DC)	25

2-4 M series

2-5 Capacitance Code : Indicating capacitance in uF by 3 letters.
 The first 2 figures are actual values and the third denotes the number of zeros.
 "R" denotes the decimal point and all figures are the actual number with "R".
 For example, 1uF is expressed as 010 in this case.

ex. 0.1μF → 0R1 , 10μF → 100 , 1000μF → 102

2-6 Suffix Code for Appearance : Special Code for Appearance

Blank	Standard Long Lead
-------	--------------------

Parts lists

	Part No.	W.V. [V.DC]	Cap. [μF] (120Hz) (20°C)	Tangent of loss angle max. (120Hz) (20°C)	Leakage Current [μA] max. (After 2 min.)	Rated Ripple Current [mA rms] max. (120Hz) (85°C)	Dim. [mm]		
							φD	L	φd
	ECA1EM470	25	47	0.16	11.8	130.0	5.0	11	0.5

3. Dimensions and Appearance

Body Color (Dark Blue) , Marking (White)
 Standard Long Lead (Suffix : Blank)

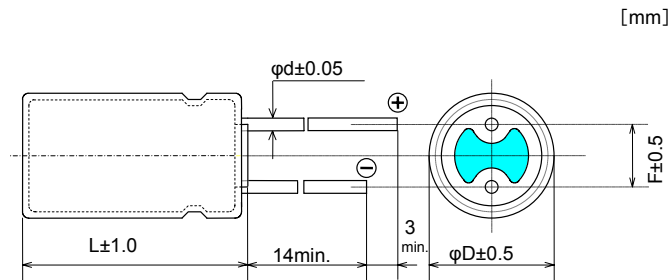

[mm]

Body Dia. ϕD	5
Lead Space F	2.0
Lead Dia. ϕd	0.5

Please refer to L dimension on the parts number lists table.

4. Constructions

4-1 Inside Construction

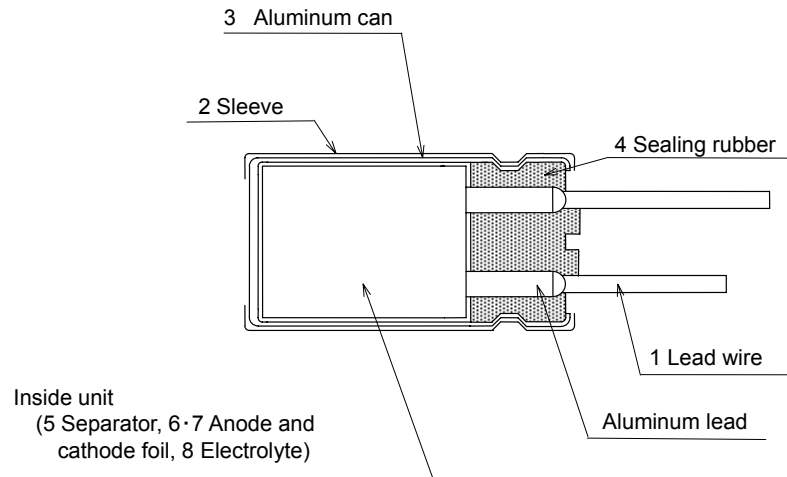

4-2 Construction Parts

Parts	Materials	Parts	Materials
1 Lead Wire	Solid tinned copper weld steel wire	5 Separator	Cellulose
2 Sleeve	Thermoplastic Resin	6 Anode Foil	High Purity Aluminum Foil
3 Aluminum Can	Aluminum	7 Cathode Foil	Aluminum Foil
4 Sealing Rubber	Synthetic rubber (EPT/IIR)	8 Electrolyte	Organic Solvent , Organic Acid (No Quaternary Salt)

5. Marking

Markings indicated on the products :

- a) Rated Voltage.
- b) Capacitance
- c) Negative Polarity
- d) Manufacturer's Trademark
- e) Upper Category Temperature
- f) Series Code
- g) Lot No. (It indicates to Lot No. System)

Product Specification

A-M-EM-59

Radial lead type Lot No. System

5

•JAPAN PRODUCTS

Lot number is indicated on a sleeve in following manner.
eg. For 04 type, expressed in 4 figures, or 5 figures.

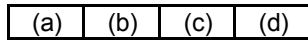

As for the display contents of 4 figures, there are 2 kinds

- (1) { (a) last number of year
(b) month (1 to 9 and O for October, N for November, D for December)
(c) week (1 to 5 and A to E)
(d) line code in alphabet (A to Z)

- (2) { (a) last number of year
(b) month (1 to 9 and O for October, N for November, D for December)
(c) line code in alphabet (A to Z)
(d) production date

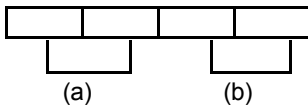

- (a) last 2 digit of year
(b) numerical indication of week (ninth week of 1992=09)

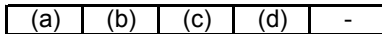

- (a) last number of year
(b) month (1 to 9 and O for October, N for November, D for December)
(c) week (1 to 5 and A to E)
(d) line code

production year	production month	production week	production date
0:2010	1:January	7:July	A,1: first week A=1 date 1=27 date
1:2011	2:February	8:August	B,2:second week B=2 2=28
2:2012	3:March	9:September	C,3: third week C=3 3=29
3:2013	4:April	O:October	D,4: forth week ? 4=30
Indicating with the last digit or the last 2 digits of a year.	5:May	N:November	E,5: fifth week Y=25 5=31
	6:June	D:December	Z=26

- * Lot number can be written in both horizontal and vertical directions.
- * Manufacturing country for certain products may not be indicated.

※ Letters and marks are also used to distinguish different lines, machines and shifts operation.

Product Specification	A-M-EM-59
Radial lead type Lot No. System	6

•MALAYSIA PRODUCTS

Lot number is indicated on a sleeve in following manner.
 eg. For 04 type, expressed in 4 figures, 5 figures or 6 figures.



- As for the display contents of 4 figures, there are 2 kinds
- (1) { (a) last number of year
 (b) month (1 to 9 and O for October, N for November, D for December)
 (c) production date (A to Z and 1 to 5)
 (d) line code in alphabet (A to Z)
- (2) { (a) line code in alphabet (A to Z)
 (b) production date (A to Z and 1 to 5)
 (c) month (1 to 9 and O for October, N for November, D for December)
 (d) last number of year

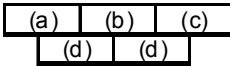

- (a) last number of year
 (b) month (1 to 9 and O for October, N for November, D for December)
 (c) week (Greece number)
 (d) line code in alphabet (A to Z)

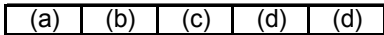

- (a) last number of year
 (b) month (1 to 9 and O for October, N for November, D for December)
 (c) week (Greece number) or production date (1 to 9 expression)
 (d) line code in alphabet (A to Z)

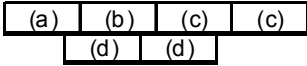

- (a) last number of year
 (b) month (1 to 9 and O for October, N for November, D for December)
 (c) production date (01 to 31 expression)
 (d) line code in alphabet (A to Z)



- (a) last number of year
 (b) month (1 to 9 and O for October, N for November, D for December)
 (c) production date (01 to 31 expression)
 (d) line code in alphabet (A to Z)

production year	production month	production week	production date
0:2010	1:January	7:July	I : first week
1:2011	2:February	8:August	II :second week
2:2012	3:March	9:September	III : third week
3:2013	4:April	O:October	IV: forth week
Indicating with the last digit or the last 1 digits of a year.	5:May	N:November	V : fifth week
	6:June	D:December	

* Lot number can be written in both horizontal and vertical directions.

6. Standard Ratings

No.	Item	Ratings	
1	Category Temperature Range	-25°C ~ +85°C	
2	Rated Voltage Range	25 V.DC	
3	Capacitance Range	47 μF (120Hz 20°C)	
4	Capacitance Tolerance	± 20% (120Hz 20°C)	
5	Surge Voltage (V.DC)	R.V.	25
		S.V.	32
6	Rated Ripple Current	Parts Lists and Table2	

7. Performance Characteristics

No	Item	Performance Characteristics	Test																		
1	Leakage Current	$\leq I = 0.01CV$ I : Leakage current C : Capacitance V : Rated voltage	Series Resistor : $1000\Omega \pm 10\Omega$ Applied Voltage : Rated voltage Measuring : After 2 minutes																		
2	Capacitance	Within the specified capacitance tolerance.	Measuring Frequency : $120 \text{ Hz} \pm 20\%$ Measuring Circuit : Equivalent series circuit Measuring Voltage : +1.5V. DC ~ +2 V. DC ($\leq 0.5V$ for AC.)																		
3	Tangent of Loss Angle (tan δ)	Less than the value of Partlists.	Measuring Frequency : $120 \text{ Hz} \pm 20\%$ Measuring Circuit : Equivalent series circuit Measuring Voltage : +1.5V. DC ~ +2 V. DC ($\leq 0.5V$ for AC.)																		
4	Characteristics at High and Low Temperature	Step 2																			
		Impedance Ratio : Ratio for the value in step 1 shall be less than the value from table 1 in item 8.	Step																		
		Step 4																			
		Leakage Current : $\leq 500\%$ of the value of item 7. 1. Capacitance Change : Within $\pm 25\%$ of the value in step 1 Tangent of Loss Angle (tan δ): \leq the value of item 7. 3.																			
			<table border="1"> <thead> <tr> <th>Step</th> <th>Test Temperature (°C)</th> <th>Time</th> </tr> </thead> <tbody> <tr> <td>1</td> <td>20 ± 2</td> <td>—————</td> </tr> <tr> <td>2</td> <td>※</td> <td>————— *</td> </tr> <tr> <td>3</td> <td>20 ± 2</td> <td>15 minutes</td> </tr> <tr> <td>4</td> <td>85 ± 2</td> <td>2 hours</td> </tr> <tr> <td>5</td> <td>20 ± 2</td> <td>————— *</td> </tr> </tbody> </table>	Step	Test Temperature (°C)	Time	1	20 ± 2	—————	2	※	————— *	3	20 ± 2	15 minutes	4	85 ± 2	2 hours	5	20 ± 2	————— *
Step	Test Temperature (°C)	Time																			
1	20 ± 2	—————																			
2	※	————— *																			
3	20 ± 2	15 minutes																			
4	85 ± 2	2 hours																			
5	20 ± 2	————— *																			
		Impedance should be measured at the frequency of $120 \text{ Hz} \pm 10\%$. ※ [$25V: -25^\circ\text{C} \pm 3^\circ\text{C}, -40^\circ\text{C} \pm 3^\circ\text{C}$]																			
		* Capacitors should be stored at each temperature until measured impedance or capacitance is stabilized.																			
5	Surge	Leakage Current : \leq the value of item 7.1. Capacitance Change : Within $\pm 15\%$ of the initially measured value. Tangent of Loss Angle (tan δ): \leq the value of item 7. 3. Appearance : No significant change can be observed.	Test Temperature : $15^\circ\text{C} \sim 35^\circ\text{C}$ Series Protective Resistance : $R = \frac{100 \pm 50}{C}$ <table border="0"> <tr> <td>{</td> <td>R = Series protective resistance (kΩ)</td> <td>}</td> </tr> <tr> <td></td> <td>C = Capacitance (μF)</td> <td></td> </tr> </table> Test Voltage : Surge voltage item 6. 5 Applied Voltage : 1000 cycles of 30s \pm 5s "ON" and 5 min. 30 s "OFF"	{	R = Series protective resistance (k Ω)	}		C = Capacitance (μF)													
{	R = Series protective resistance (k Ω)	}																			
	C = Capacitance (μF)																				

No	Item	Performance Characteristics	Test				
6	Robustness of Terminations	There is no damage or breakage after test.	<table border="1"> <thead> <tr> <th>Diameter [mm]</th> <th>Pull Strength</th> </tr> </thead> <tbody> <tr> <td>φ0.5</td> <td>5 N</td> </tr> </tbody> </table>	Diameter [mm]	Pull Strength	φ0.5	5 N
	Diameter [mm]		Pull Strength				
φ0.5	5 N						
Tensile	Applied above steady pull axially for a 10s±1s						
	Bending		<table border="1"> <thead> <tr> <th>Diameter [mm]</th> <th>Static Load</th> </tr> </thead> <tbody> <tr> <td>φ0.5</td> <td>2.5 N</td> </tr> </tbody> </table> <p>At first, a capacitor is placed in vertical position with the weight specified above being applied to one of leads. Then the capacitor is slowly rotated 90° to horizontal position and subsequently returned to vertical position. The above bending procedure takes for 2s ~ 3s. An additional bending is done in the opposite direction.</p>	Diameter [mm]	Static Load	φ0.5	2.5 N
Diameter [mm]	Static Load						
φ0.5	2.5 N						
7	Vibration	<p>Capacitance : Measured value is to be stabilized during test. (Measured several times within 30 min. before completion of test)</p> <p>Appearance : No significant change can be observed.</p> <p>Capacitance Change : Within ±5% of the initially measured value.</p>	<p>Frequency : 10 Hz ~ 55 Hz (1 minute per cycle.)</p> <p>Total Amplitude : 1.5 mm</p> <p>Direction and Duration of Vibration : It is done in the X, Y, Z axis direction for 2 hours each, with a total of 6 hours.</p> <p>Mounting Method : The capacitor shall be fixed with its lead wires at the point of 4 mm from the bottom of capacitor body. The capacitor with diameter greater than 12.5 mm or longer than 25 mm must be fixed in place with a bracket.</p>				
8	Solderability	More than 3/4 of the terminal surface shall be covered with new solder.	<p>Solder Type : H60A, H60S, or H63A (JIS Z3282)</p> <p>Solder Temperature : 235°C±5°C</p> <p>Immersing Time : 2s±0.5s</p> <p>Immersing Depth : 1.5mm ~ 2.0mm from the root.</p> <p>Flux : Approx. 25% rosin (JIS K5902) in ETHANOL (JIS K8101)</p>				
9	Resistance to Soldering Heat	<p>Leakage Current : ≤ the value of item 7.1.</p> <p>Capacitance Change : Within ±10% of the initially measured value.</p> <p>Tangent of Loss Angle (tanδ): ≤ the value of item 7.3.</p> <p>Appearance : No significant change can be observed.</p>	<p>Solder Type : H60A, H60S, or H63A (JIS Z3282)</p> <p>Solder Temperature : 260°C±5°C</p> <p>Immersing Time : 10s±1s</p> <p>Immersing Depth : 1.5mm ~ 2.0mm from the root.</p>				

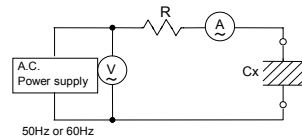
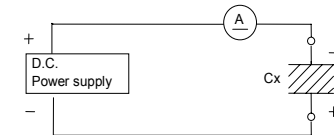
No	Item	Performance Characteristics	Test																				
10	Solvent Resistance of Marking	There shall be no damage and legible marking. Marking can be easily comprehended.	Class of Reagent : Isopropyl Alcohol Test Temperature : 20°C ~ 25°C Immersing Time : 30s±5s																				
11	Pressure Relief	Pressure relief shall be operated without any hazardous expulsion or emission of flame. No emission of gas after 30 minutes of the voltage application also meets the specification.	<p>AC Current Method</p>  <p>50Hz or 60Hz (A) : A.C. ammeter R : Series resistor (V) : A.C. voltmeter Cx : Tested capacitor</p> <p>Applied Voltage : AC voltage equals to rated W. V. × 0. 7 or 250 V (rms), whichever is smaller.</p> <table border="1"> <thead> <tr> <th>Capacitance (μF)</th> <th>DC Resistance (Ω)</th> </tr> </thead> <tbody> <tr> <td>≤ 1</td> <td>1000±100</td> </tr> <tr> <td>> 1 ≤ 10</td> <td>100±10</td> </tr> <tr> <td>> 10 ≤ 100</td> <td>10±1</td> </tr> <tr> <td>> 100 ≤ 1000</td> <td>1±0.1</td> </tr> <tr> <td>> 1000 ≤ 10000</td> <td>0.1±0.01</td> </tr> <tr> <td>> 10000</td> <td>*</td> </tr> </tbody> </table> <p>* When capacitance is over 10000μF, the value of series resistance equals to the half of the tested capacitor's impedance.</p> <p>Reverse Voltage Method</p>  <p>(A) : D.C. ammeter Cx : Tested capacitor</p> <table border="1"> <thead> <tr> <th>Nominal Diameter [mm]</th> <th>DC Current (A)</th> </tr> </thead> <tbody> <tr> <td>≤ 22.4</td> <td>1 (const)</td> </tr> <tr> <td>> 22.4</td> <td>10 (const)</td> </tr> </tbody> </table>	Capacitance (μF)	DC Resistance (Ω)	≤ 1	1000±100	> 1 ≤ 10	100±10	> 10 ≤ 100	10±1	> 100 ≤ 1000	1±0.1	> 1000 ≤ 10000	0.1±0.01	> 10000	*	Nominal Diameter [mm]	DC Current (A)	≤ 22.4	1 (const)	> 22.4	10 (const)
Capacitance (μF)	DC Resistance (Ω)																						
≤ 1	1000±100																						
> 1 ≤ 10	100±10																						
> 10 ≤ 100	10±1																						
> 100 ≤ 1000	1±0.1																						
> 1000 ≤ 10000	0.1±0.01																						
> 10000	*																						
Nominal Diameter [mm]	DC Current (A)																						
≤ 22.4	1 (const)																						
> 22.4	10 (const)																						

No	Item	Performance Characteristics	Test
12	Damp Heat (Steady state)	Leakage Current : ≤ the value of item 7.1. Capacitance Change : Within ±20% of the initially measured value. Tangent of Loss Angle (tanδ): ≤ 120% the value of item 7. 3. Appearance : No significant change can be observed.	Test Temperature : 40°C±2°C Relative Humidity : 90% ~ 95% Test Duration : 240hours ±8hours After subjected to the test, capacitors shall be left for 2 hours at room temperature and room humidity prior to the measurement.
13	Endurance	Leakage Current : ≤ the value of item 7.1. Capacitance Change : Within ±20% of the initially measured value. Tangent of Loss Angle (tanδ): ≤ 150% of the value of item 7. 3. Appearance : No significant change can be observed.	Test Temperature : 85°C±2°C Test Duration : 2000 ⁺⁷² ₀ hours Applied Voltage : Rated voltage After subjected to the test, capacitors shall be left at room temperature and room humidity for 2 hours prior to the measurement.
14	Shelf Life	Leakage Current : ≤ the value of item 7.1. Capacitance Change : Within ±20% of the initially measured value. Tangent of Loss Angle (tanδ): ≤ 150% of the value of item 7. 3. Appearance : No significant change can be observed.	Test Temperature : 85°C±2°C Test Duration : 1000 ⁺⁴⁸ ₀ hours After subjected to the test with no voltage applied, capacitors shall undergo voltage treatment* and be left for 2 hours at room temperature and humidity prior to the measurement.

* Voltage treatment : The rated voltage shall be applied to the capacitors, which are connected to series protective resistors (1000Ω±10Ω), for 30 minutes as a posttest treatment (performing discharge).

8. Other Characteristics

- Table 1.Characteristics at low temperature Impedance ratio (at 120 Hz)

V.DC	25
Z(-25°C)/Z(20°C)	2
Z(-40°C)/Z(20°C)	5

- Table 2.Frequency Correction Factor of Rated Ripple Current

	Frequency (Hz)			
	50,60	120	1k	10k~
Coefficient	0.7	1	1.3	1.7

Product Specification	A-M-EM-59
Radial lead type Package Amount and Shape	13

Label information on the packing box.

The label has following information in English

- a) Rated Voltage, Capacitance
- b) Part Number
- c) Packing Quantity
- d) Serial No.
- e) Manufacturer's Name
- f) Country of Origin

Package Label Example
Long lead Outer Box

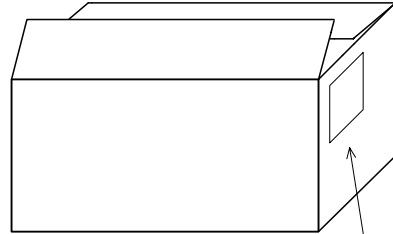

Long lead (Unit:pcs)

Can size	Long lead	
	Packaging Quantity	Packaging Quantity per box
φ5x11	200	10000

Contents of label description

- (1) Customer Part No.
- (2) Quantity
- (3) Rated Capacitance
- (4) Voltage
- (5) Can Size
- (6) Product Part No.

Package Material

	Long lead
Inner	Vinyl bag
Outer	Card board

<JAPAN PRODUCTS>

Customer Part No.		G
(1)		
(3N) 1	(1)	(2)
(3N) 2	Y5201R41A001	108010
FIXED ALUMINIUM ELECTROLYTIC CAPACITOR		
(6)	(3) uF	(4) V
(2)	(5) φ × L	
Serial No. Y5201R41A001		
Panasonic Corporation		
Panasonic		MADE IN JAPAN EIAJ C-3 0 0 1

<MALAYSIA PRODUCTS>

Customer Part No.		Production month	G
(1)			
(3N) 1	(1)	(2)	(3) uF
			(4) V
(3N) 2	D0002R03D428	108010	(5) φ × L
FIXED ALUMINIUM ELECTROLYTIC CAPACITOR			Serial No. D0002R03D428
(6)			(2) PCS.
Panasonic		Panasonic Industrial Devices (M) Sdn. Bhd. EIAJ-C3 PIDMY Made in Malaysia	

Product Specification	Guideline-ALA-S-2
Application Guidelines	Guidelines-1

- * This specification guarantees the quality and performance of the product as individual components.
Before use, check and evaluate their compatibility with installed in your products.
- * Do not use the products beyond the specifications described in this document.
- * Install the following systems for a failsafe design to ensure safety if these products are to be used in equipment where a defect in these products may cause the loss of human life or other signification damage, such as damage to vehicles (automobile, train, vessel), traffic lights, medical equipment, aerospace equipment, electric heating appliances, combustion/ gas equipment, rotating equipment, and disaster/crime prevention equipment.
 - The system is equipped with a protection circuit and protection device.
 - The system is equipped with a redundant circuit or other system to prevent an unsafe status in the event of a single fault.
- * Before using the products, carefully check the effects on their quality and performance, and determined whether or not they can be used.
These products are designed and manufactured for general-purpose and standard use in general electronic equipment.
These products are not intended for use in the following special conditions.
 1. In liquid, such as Water, Oil, Chemicals, or Organic solvent
 2. In direct sunlight, outdoors, or in dust
 3. In vapor, such as dew condensation water of resistive element, or water leakage, salty air, or air with a high concentration corrosive gas, such as Cl₂, H₂S, NH₃, SO₂, or NO₂
 4. In an environment where strong static electricity or electromagnetic waves exist
 5. Mounting or placing heat-generating components or inflammables, such as vinyl-coated wires, near these products
 6. Sealing or coating of these products or a printed circuit board on which these products are mounted, with resin and other material
 7. Using resolvent, water or water-soluble cleaner for flux cleaning agent after soldering.
(In particular, when using water or a water-soluble cleaning agent, be careful not to leave water residues)
- * Please arrange circuit design for preventing impulse or transitional voltage.
Do not apply voltage, which exceeds the full rated voltage when the capacitors receive impulse voltage, instantaneous high voltage, high pulse voltage etc.
- * Electrolyte is used in the products. Therefore, misuse can result in rapid deterioration of characteristics and functions of each product.
Electrolyte leakage damages printed circuit and affects performance, characteristics, and functions of customer system.

1. Circuit Design

1.1 Operating Temperature and Frequency

Electrical parameters for electrolytic capacitors are normally specified at 20°C temperature and 120 Hz frequency. These parameters vary with changes in temperature and frequency. Circuit designers should take these changes into consideration.

- (1) Effects of operating temperature on electrical parameters
 - a) At higher temperatures, leakage current and capacitance increase while equivalent series resistance (ESR) decreases.
 - b) At lower temperatures, leakage current and capacitance decrease while equivalent series resistance (ESR) increases.
- (2) Effects of frequency on electrical parameters
 - a) At higher frequencies, capacitance and impedance decrease while $\tan \delta$ increases.
 - b) At lower frequencies, heat generated by ripple current will rise due to an increase in equivalent series resistance (ESR).

1.2 Operating Temperature and Life Expectancy

- (1) Expected life is affected by operating temperature. Generally, each 10 °C reduction in temperature will double the expected life.
Use capacitors at the lowest possible temperature below the upper category temperature.
- (2) If operating temperatures exceed the upper category limit, rapid deterioration of electrical parameter will occur and irreversible damage will result.
Check for the maximum capacitor operating temperatures including ambient temperature, internal capacitor temperature rise due to ripple current, and the effects of radiated heat from power transistors, IC's or resistors.
Avoid placing components, which could conduct heat to the capacitor from the back side of the circuit board.
- (3) The formula for calculating expected life at lower operating temperatures is as follows ;

$$L_2 = L_1 \times 2^{\frac{T_1 - T_2}{10}}$$

L_1 : Guaranteed life (h) at temperature, T_1 °C

L_2 : Expected life (h) at temperature, T_2 °C

T_1 : Upper category temperature (°C)

T_2 : Actual operating temperature, ambient temperature + temperature rise due to ripple current heating(°C)

- (4) Please use according to the lifetime as noted in this specification. Using products beyond end of the lifetime may change characteristics rapidly, short-circuit, operate pressure relief vent, or leak electrolyte.

Product Specification	Guideline-ALA-S-2
Application Guidelines	Guidelines-2

1.3 Common Application Conditions to Avoid

The following misapplication load conditions will cause rapid deterioration of a capacitor's electrical parameters. In addition, rapid heating and gas generation within the capacitor can occur, causing the pressure relief vent to operate and resultant leakage of electrolyte. Under extreme conditions, explosion and fire ignition could result. The leaked electrolyte is combustible and electrically conductive.

- (1) Reverse Voltage
DC capacitors have polarity. Verify correct polarity before insertion. For circuits with changing or uncertain polarity, use DC bipolar capacitors. DC bipolar capacitors are not suitable for use in AC circuits.
- (2) Charge / Discharge Applications
Standard capacitors are not suitable for use in repeating charge/discharge applications. For charge/ discharge applications, consult us with your actual application condition.
- (3) ON-OFF circuit
Do not use capacitors in circuit where ON-OFF switching is repeated more than 10000 times/per day. In case of applying to the theses ON-OFF circuit, consult with us about circuit condition and so on.
- (4) Over voltage
Do not apply voltages exceeding the maximum specified rated voltage. Voltages up to the surge voltage rating are acceptable for short periods of time.
Ensure that the sum of the DC voltage and the superimposed AC ripple voltage does not exceed the rated voltage.
- (5) Ripple Current
Do not apply ripple currents exceeding the maximum specified value. For high ripple current applications, use a capacitor designed for high ripple currents. In addition, consult us if the applied ripple current is to be higher than the maximum specified value.
Ensure that rated ripple currents that superimposed on low DC bias voltages do not cause reverse voltage conditions.

1.4 Using Two or More Capacitors in Series or Parallel

- (1) Capacitors Connected in Parallel
The circuit resistance can closely approximate the series resistance of the capacitor, causing an imbalance of ripple current loads within the capacitors. Careful wiring methods can minimize the possible application of an excessive ripple current to a capacitor.
- (2) Capacitors Connected in Series
Differences in normal DC leakage current among capacitors can cause voltage imbalances.
The use of voltage divider shunt resistors with consideration to leakage currents can prevent capacitor voltage imbalances.

1.5 Capacitor Mounting Considerations

- (1) Double-Sided Circuit Boards
Avoid wiring pattern runs, which pass between the mounted capacitor and the circuit board. When dipping into a solder bath, an excess solder may deposit under the capacitor by capillary action, causing short circuit between anode and cathode terminals.
- (2) Circuit Board Hole Positioning
The vinyl sleeve of the capacitor can be damaged if solder passes through a lead hole into the subsequently processed parts. Special care when locating hole positions in proximity to capacitors is recommended.
- (3) Circuit Board Hole Spacing
The spacing of circuit board holes should match the lead wire spacing of capacitors within the specified tolerances. Incorrect spacing can cause an excessive lead wire stress during the insertion process. This may result in premature capacitor failure due to the short or open circuit, increased leakage current, or electrolyte leakage.
- (4) Clearance for Case Mounted Pressure Relief
Capacitors with case mounted pressure relief require sufficient clearance to allow proper pressure relief operation. The minimum clearances are dependent of capacitor diameters as follows.
(Dia. 6.3 mm ~Dia. 16 mm : 2 mm minimum, Dia. 18 mm ~Dia. 35 mm : 3 mm minimum, Dia 40 mm or greater : 5 mm minimum.)
- (5) Clearance for Seal Mounted Pressure Relief
Provide a hole on a circuit board to relieve gas when a pressure relief of a capacitor is situated underneath of the circuit board.
- (6) Wiring Near the Pressure Relief
Avoid locating high voltage, high current wiring, or circuit board paths above the pressure relief.
Flammable, high temperature gas that exceeds 100 °C may be released and could dissolve the wire insulation and ignite.
- (7) Circuit Board Patterns Under the Capacitor
Avoid circuit board runs underneath the capacitor, as an electrical short can occur due to an electrolyte leakage.
- (8) Screw Terminal Capacitor Mounting
Do not orient the capacitor with the screw terminal side of the capacitor facing downward.
Tighten the terminal and mounting bracket screws within the torque range specified in the specification.

1.6 Electrical Isolation of the Capacitor

Completely isolate the capacitor as follows.

- (1) Between the cathode and the case (except for axially leaded B types) and between the anode terminal and other circuit paths.
- (2) Between the extra mounting terminals (on T types) and the anode terminal, cathode terminal, and other circuit paths.

1.7 Capacitor Sleeve

The vinyl sleeve or laminate coating is intended for marking and identification purposes and is not meant to electrically insulate the capacitor. The sleeve may split or crack if immersed into solvents such as toluene or xylene and then subsequently exposed to high temperatures.

Product Specification	Guideline-ALA-S-2
Application Guidelines	Guidelines-3
<p>2. Capacitor Handling Techniques</p> <p>2.1 Considerations Before Using</p> <ol style="list-style-type: none"> (1) Capacitors have a finite life. Do not reuse or recycle capacitors from used equipment. (2) Transient recovery voltage may be generated in the capacitor due to dielectric absorption. If required, this voltage can be discharged with a resistor with a value of about 1kΩ. (3) Capacitors stored for a long period of time may exhibit an increase in leakage current. This can be corrected by gradually applying rated voltage in series with a resistor of approximately 1kΩ. (4) If capacitors are dropped, they can be damaged mechanically or electrically. Avoid using dropped capacitors. (5) Dented or crushed capacitors should not be used. The seal integrity can be damaged and loss of electrolyte/shortened life can result. <p>2.2 Capacitor Insertion</p> <ol style="list-style-type: none"> (1) Verify the correct capacitance and rated voltage of the capacitor. (2) Verify the correct polarity of the capacitor before insertion. (3) Verify the correct hole spacing before insertion (land pattern size on chip type) to avoid stress on the terminals. (4) Ensure that the lead clinching operation done by auto insertion equipments does not stress the capacitor leads where they enter the seal of the capacitor. For chip type capacitors, excessive mounting pressure can cause high leakage current, short circuit, or disconnection. <p>2.3 Manual Soldering</p> <ol style="list-style-type: none"> (1) Apply soldering conditions (temperature and time) based on the specification, or do not exceed temperature of 350 °C for 3 seconds or less. (2) If lead wires must be modified to meet terminal board hole spacing, avoid stress on the lead wire where it enters the capacitor seal. (3) If a soldered capacitor must be removed and reinserted, avoid excessive stress on the capacitor leads. (4) Avoid physical contacts between the tip of the soldering iron and capacitors to prevent melting of the vinyl sleeve. <p>2.4 Flow Soldering</p> <ol style="list-style-type: none"> (1) Do not immerse the capacitor body into the solder bath as excessive internal pressure could result. (2) Apply proper soldering conditions (temperature, time, etc.). Do not exceed the specified limits. (3) Do not allow other parts or components to touch the capacitor during soldering. <p>2.5 Other Soldering Considerations</p> <p>Rapid temperature rise during the preheat operation and resin bonding operation can cause cracking of the capacitor's vinyl sleeve. For heat curing, do not exceed 150 °C for the maximum time of 2 minutes.</p> <p>2.6 Capacitor Handling after Soldering</p> <ol style="list-style-type: none"> (1) Avoid moving the capacitor after soldering to prevent excessive stress on the lead wires where they enter the seal. (2) Do not use the capacitor as a handle when moving the circuit board assembly. (3) Avoid striking the capacitor after assembly to prevent failure due to excessive shock. <p>2.7 Circuit Board Cleaning</p> <ol style="list-style-type: none"> (1) Circuit boards can be immersed or ultrasonically cleaned using suitable cleaning solvents for up to 5 minutes and up to 60 °C maximum temperatures. The boards should be thoroughly rinsed and dried. The use of ozone depleting cleaning agents is not recommended for the purpose of protecting our environment. (2) Avoid using the following solvent groups unless specifically allowed in the specification ; <ul style="list-style-type: none"> • Halogenated cleaning solvents : except for solvent resistant capacitor types, halogenated solvents can permeate the seal and cause internal capacitor corrosion and failure. For solvent resistant capacitors, carefully follow the temperature and time requirements based on the specification. 1-1-1 trichloroethane should never be used on any aluminum electrolytic capacitor. • Alkaline solvents : could react and dissolve the aluminum case. • Petroleum based solvents : deterioration of the rubber seal could result. • Xylene : deterioration of the rubber seal could result. • Acetone : removal of the ink markings on the vinyl sleeve could result. (3) A thorough drying after cleaning is required to remove residual cleaning solvents that may be trapped between the capacitor and the circuit board. Avoid drying temperatures, which exceed the Upper category temperature of the capacitor. (4) Monitor the contamination levels of the cleaning solvents during use in terms of electrical conductivity, pH, specific gravity, or water content. Chlorine levels can rise with contamination and adversely affect the performance of the capacitor. (5) Depending on the cleaning method, the marking on a capacitor may be erased or blurred. Please consult us if you are not certain about acceptable cleaning solvents or cleaning methods. <p>2.8 Mounting Adhesives and Coating Agents</p> <p>When using mounting adhesives or coating agents to control humidity, avoid using materials containing halogenated solvents. Also, avoid the use of chloroprene based polymers. Harden on dry adhesive or coating agents well lest the solvent should be left. After applying adhesives or coatings, dry thoroughly to prevent residual solvents from being trapped between the capacitor and the circuit board.</p> <p>2.9 Fumigation</p> <p>In exporting electronic appliances with aluminum electrolytic capacitors, in some cases fumigation treatment using such halogen compound as methyl bromide is conducted for wooden boxes. If such boxes are not dried well, the halogen left in the box is dispersed while transported and enters in the capacitors inside. This possibly causes electrical corrosion of the capacitors. Therefore, after performing fumigation and drying make sure that no halogen is left. Don't perform fumigation treatment to the whole electronic appliances packed in a box.</p>	

Product Specification	Guideline-ALA-S-2
Application Guidelines	Guidelines-4
<p>3. Precautions for using capacitors</p> <p>3.1 Environmental Conditions</p> <p>Capacitors should not be stored or used in the following environments.</p> <ol style="list-style-type: none"> (1) Exposure to temperatures above the upper category or below the lower category temperature of the capacitor. (2) Direct contact with water, salt water, or oil. (3) High humidity conditions where water could condense on the capacitor. (4) Exposure to toxic gases such as hydrogen sulfide, sulfuric acid, nitric acid, chlorine, Chlorine compound, Bromine, Bromine compound or ammonia. (5) Exposure to ozone, radiation, or ultraviolet rays. (6) Vibration and shock conditions exceeding specified requirements. <p>3.2 Electrical Precautions</p> <ol style="list-style-type: none"> (1) Avoid touching the terminals of a capacitor as a possible electric shock could result. The exposed aluminum case is not insulated and could also cause electric shock if touched. (2) Avoid short circuiting the area between the capacitor terminals with conductive materials including liquids such as acids or alkaline solutions. (3) A low-molecular-weight-shiroxane which is included in a silicon material shall causes abnormal electrical characteristics. <p>4. Emergency Procedures</p> <ol style="list-style-type: none"> (1) If the pressure relief of the capacitor operates, immediately turn off the equipment and disconnect from the power source. This will minimize an additional damage caused by the vaporizing electrolyte. (2) Avoid contact with the escaping electrolyte gas, which can exceed 100 °C temperatures. If electrolyte or gas enters the eye, immediately flush the eye with large amounts of water. If electrolyte or gas is ingested by mouth, gargle with water. If electrolyte contacts the skin, wash with soap and water. <p>5. Long Term Storage</p> <p>Leakage current of a capacitor increases with long storage times. The aluminum oxide film deteriorates as a function of temperature and time. If used without reconditioning, an abnormally high current will be required to restore the oxide film. This surge current could cause the circuit or the capacitor to fail. Storage period is one year. When storage period is over 12 months, a capacitor should be reconditioned by applying the rated voltage in series with a 1000 Ω current limiting resistor for a time period of 30 minutes. For storage condition, keep room temperature (5°C~35°C) and humidity (45%~85%) where direct sunshine doesn't reach.</p> <p>5.1 Environmental Conditions</p> <ol style="list-style-type: none"> (1) Exposure to temperatures above the upper category or below the lower category temperature of the capacitor. (2) Direct contact with water, salt water, or oil. (3) High humidity conditions where water could condense on the capacitor. (4) Exposure to toxic gases such as hydrogen sulfide, sulfuric acid, nitric acid, chlorine, Chlorine compound, Bromine, Bromine compound or ammonia. (5) Exposure to ozone, radiation, or ultraviolet rays. (6) Vibration and shock conditions exceeding specified requirements. <p>6. Capacitor Disposal</p> <p>When disposing capacitors, use one of the following methods.</p> <ol style="list-style-type: none"> (1) Incinerate after crushing the capacitor or puncturing the can wall (to prevent explosion due to internal pressure rise). (2) Dispose as solid waste. <p>NOTE : Local laws may have specific disposal requirements which must be followed.</p>	