

Founded in 1945, Weller has become the world's leading supplier of professional quality soldering equipment, including the famous Weller temperature controlled irons and soldering guns. Weller also makes advanced soldering and desoldering stations, SMT equipment and irons for sophisticated industrial requirements, plus a series of handy soldering kits for home craftsmen, hobbyists and light industry.

## IMPORTANT NOTE

Just click on the  
item you want.



## Contents

MicroTouch Plus™ (MT) soldering stations

Electronically controlled (EC) soldering stations

Irons for electronically controlled soldering stations

Weller®/Ungar® Electronic soldering system

Controlled-output soldering stations

Stained glass station

Controlled-output soldering irons

Professional soldering irons

Weller®/Ungar® Pro Plus™ series soldering irons

Temtronic soldering pencil

Marksman® soldering irons

Cordless soldering tools

Solder fume extraction systems

Soldering stations with fume extraction irons

Irons for fume extraction systems

Weller® fume extraction adapter table

Desoldering stations

Weller® Temperature controlled rework stations

Manual desoldering tools

Surface mount products

Accessory products-electronic soldering stations

Accessory products-iron stands

Accessory products-miscellaneous

Tips for electronic soldering stations

Tips for controlled output soldering irons

Tips for professional soldering irons

Tips for surface mount products

Tips for Marksman® soldering tools

Tips for cordless soldering tools

Tiptets for desoldering tools

Desoldering accessories for Surface Mount Technology (SMT)

Consumer products

	PRODUCTION	MRO & SERVICE	DESOLDERING REWORK	HOT AIR	SURFACE MOUNT	MIL SPEC	ESD	TEST	DISPENSING	CORDLESS	LOCKOUT	FUME REMOVAL	HOBBYIST
EC2002M	•				•	•	•						
EC1002	•				•	•	•						
WTL1000	•				•	•	•				•		
DEC1001	•	•	•		•	•	•						
DTL1000	•	•	•		•	•	•				•		
WTCPT	•	•			•		•				•		
Fume Extract												•	
DS800			•			•	•						
DS700M		•	•										
DS600			•										
MT1500(L)	•	•			•		•				•		
WRS3000			•	•	•	•	•				•		
WRS2000			•	•	•	•	•		•				
WRS1000			•	•	•	•	•						
AG75				•	•								
WA2000								•					
WCC100		•											•
7200PK													•
8200													•
D550		•											•
P1									•				
WPA2										•			
WLC100													•
WLC200													•
WHA700			•	•	•	•	•						
WHA2000			•	•	•	•	•						

## The simple answer to high quality, versatile ESD safe soldering.

Enter the new age of ESD safe soldering with Weller®. Weller's new blue family of high precision soldering equipment is recognized throughout the industry as the most sophisticated and versatile, whether applied to electronic industrial needs, high volume assembly, rework or repair.

Now, Weller makes soldering selection easier. Weller has taken five popular stations and three irons from which the optimal soldering work stations can be selected. Various station/iron combinations can be applied to endless soldering jobs... that means more versatility.

Reliable Weller quality is built into each compact unit which has its own extremely accurate temperature control system. All casings are made of durable electrostatic protective material in unique Weller blue. The iron stand may be used separately from the main power unit or attached to either side for easy use by left or right hand. The stand has a water reservoir and storage space for six tips. Plus, the antistatic iron cord has flexible cord guard to extend cord life.

Every station is 100% quality inspected!

### MicroTouch Plus™ Soldering Station MT1500, MT1500L



- Immediate, accurate tip temperature for faster soldering - (MT202-3 seconds)
- Quick tip change system, no tools required
- Expanded tip selection - .010 point to PLCC68 (over 50 available)
- Touch feature for extended tip life - reduces operating cost
- Excellent thermal capacity - improves performance in all applications
- Immediate response to thermal loads - improves productivity
- Complete control with adjustable temperature and digital display
- Three basic Modes:
  - Touch Mode: Intended for soldering very small components with microtips
  - Idle Mode: Similar to Touch Mode, but uses large tips
  - Continuous Mode: Suited for very large surface mount device tips
- Average tip temperature is calibrated to  $\pm 9^{\circ}\text{F}$  ( $\pm 5^{\circ}\text{C}$ ) at idle with no load
- Tip temperature range 400°F to 800°F (204°C to 427°C)
- Stability  $\pm 10^{\circ}\text{F}$  ( $\pm 6^{\circ}\text{C}$ )
- Control setting resolution 1°F (1°C)
- Unit not provided with tip - Tips to be purchased separately
- MT series tips listed on page Weller 58

Cat. No.	UPC No.	Description	V	W	Hz	Shelf Pack Wt.		Shelf Pack
						lb	kg	
MT1500	037103108883	Complete station w/o tip	120	150	60	7.4	3.4	1
MT1500L	037103127761	Complete station w/o tip, with operator lockout	120	150	60	7.4	3.4	1
<b>The following is available only to authorized export distributors. Units not VDE or GS approved.</b>								
MT1500D	037103110794	Complete station w/o tip	230	150	60	7.4	3.4	1

# Electronic controlled (EC) soldering stations EC2002M



ESD SAFE

- LED readout displays temperature settings and tip temperature with a resolution of 1°F (1°C) and stability of ±10°F (±6°C)
- Display shows “Read” mode by default which displays current temperature of the tip
- To switch to “Set” mode, turn knob slightly, display will show current set temperature
- Handles delicate applications
- Electrostatic discharge safe (ESD safe)
- Available with 40, 20 or 42 watt iron stand, with tip storage, positions left, right or remote from main unit
- Water reservoir keeps sponge moist
- SPEC. COMPLIANCE: DOD-STD-2000, Mil-STD-2000, Mil-S-45743, W-S-6536, W-S-570 and DOD-STD-1686
- Externally fused
- See iron fume extraction adapter kit table on page Weller 27
- UL listed and FCC approved



Optional Features Available (Using WCM-1 Calibrator, See page Weller 43)

- Calibrator to factory reset or custom offset
- Lockout provides temperature lockout on a variable temperature station
- Set back feature provides operator determination set back timing to 350°F/Automatic 99 minute station shut down

Cat. No.	UPC No.	Description	V	W	Hz	Shelf Pack Wt.		Shelf Pack
						lb	kg	
EC2002M0	037103103284	Power unit-24V Output	120	60	60	3.75	1.69	1
EC2002M1	037103103291	Complete station w/EC1201Airon & stand				4.00	1.80	1
EC2002M2	037103103260	Complete station w/EC1302Airon & stand				3.75	1.69	1
EC2002M3	037103103277	Complete station w/EC1503Airon & stand				3.75	1.69	1
<b>The following is available only to authorized export distributors. Units not VDE or GS approved.</b>								
EC2002M0D	037103000552	Power unit only	240	60	50/60	3.75	1.69	1
EC2002M1D	037103000569	Complete station w/EC1201A iron & stand				4.00	1.80	1
EC2002M2D	037103000576	Complete station w/EC1302Airon & stand				4.00	1.80	1
EC2002M3D	037103000583	Complete station w/EC1503A iron & stand				4.00	1.80	1



Station No.: **EC2002M1**  
**EC1201A** 40w iron w/ETA tip & stand.  
 Tips listed on page Weller 57.



Station No.: **EC2002M2**  
**EC1302A** 20w iron w/EPH101 tip & stand.  
 Tips listed on page Weller 60.



Station No.: **EC2002M3**  
**EC1503A** 42w iron w/EMA tip & stand.  
 Tips listed on page Weller 61.

# EC1002



ESD SAFE



- Dial calibrated in 10°F (6°C) increments
- Power control with zero cross switching for tips free of high voltage spikes
- Electrostatic discharge safe (ESD safe)
- True protection for sensitive, electronic components
- Available with 40, 20 or 42 watt iron
- Iron stand, with tip storage, positions left, right or remote from main unit
- SPEC. COMPLIANCE: DOD-STD-2000, Mil-STD-2000, Mil-S-45743, W-S-6536, W-S-570 and DOD-STD-1686
- Unit allows external calibration by user
- Externally fused
- See iron fume extraction adapter kit table on page Weller 27
- UL listed

Cat. No.	UPC No.	Description	V	W	Hz	Shelf Pack Wt.		Shelf Pack
						lb	kg	
EC10020	037103000514	Power unit-24V Output	120	60	60	3.75	1.69	1
EC10021	037103000439	Complete station w/EC1201A iron & stand				4.00	1.80	1
EC10022	037103000446	Complete station w/EC1302A iron & stand				4.00	1.80	1
EC10023	037103000453	Complete station w/EC1503A iron & stand				4.00	1.80	1
<b>The following is available only to authorized export distributors. Units not VDE or GS approved.</b>								
EC10020D	037103000521	Power unit only	240	60	50/60	3.75	1.69	1
EC10021D	037103000491	Complete station w/EC1201A iron & stand				4.00	1.80	1
EC10022D	037103000507	Complete station w/EC1302A iron & stand				4.00	1.80	1
EC10023D	037103000538	Complete station w/EC1503A iron & stand				4.00	1.80	1



Station No.: **EC10021**  
**EC1201A** 40w iron w/ETA tip & stand.  
 Tips listed on page Weller 57.



Station No.: **EC10022**  
**EC1302A** 20w iron w/EPH101 tip & stand.  
 Tips listed on page Weller 60.



Station No.: **EC10023**  
**EC1503A** 42w iron w/EMAtip & stand.  
 Tips listed on page Weller 61.





- Tip temperature controlled by Thermolock® “keys” - PROVIDES OPERATOR LOCKOUT
- Tip temperature automatically set to within ±10°F with Thermolock® “key” installed
- Safety feature powers iron down to 350°F if “key” is removed while unit is on
- Electrostatic discharge safe (ESD safe)
- For use with 40, 20, 42 watt irons
- Iron stand, with tip storage, positions left, right or remote from main unit
- SPEC. COMPLIANCE: DOD-STD-2000, Mil-STD-2000, Mil-S-45743, W-S-6536, W-S-570 and DOD-STD-1686
- Unit allows calibration by user
- 700°F, 750°F, 800°F temperature keys included
- Externally fused
- See iron fume extraction adapter kit table on page Weller 27
- UL listed



Cat. No.	UPC No.	Description	V	W	Hz	Shelf Pack Wt.		Shelf Pack
						lb	kg	
WTL10000	037103593276	Power unit-24V Output	120	60	60	3.75	1.69	1
WTL10001	037103593221	Complete station w/EC1201Airon & stand				4.00	1.80	1
WTL10002	037103593238	Complete station w/EC1302Airon & stand				4.00	1.80	1
WTL10003	037103593245	Complete station w/EC1503Airon & stand				4.00	1.80	1

The following is available only to authorized export distributors. Units not VDE or GS approved.

WTL10000D	037103027429	Power unit only	240	60	50/60	3.75	1.69	1
WTL10001D	037103024701	Complete station w/EC1201Airon & stand				4.00	1.80	1
WTL10002D	037103024718	Complete station w/EC1302Airon & stand				4.00	1.80	1
WTL10003D	037103027436	Complete station w/EC1503Airon & stand				4.00	1.80	1

Cat. No.	UPC No.	Description	Shelf Pack	Color Code	Temp °F	For Soldering Tip Style
TL600A	037103593252	Temperature key	1	White	600	ETA, ETAA, ETB, ETBB, ETC, ETCC
TL650A	037103593016	Temperature key	1	White	650	ETD, ETDD, ETH, ETP
TL700A	037103593023	Temperature key	1	White	700	EPH101, EPH102, EPH103, EPH104
TL750A	037103592910	Temperature key	1	White	750	EPH107, EPH108, EPH109, EPH110
TL800A	037103592927	Temperature key	1	White	800	EMA, EMB, EMH, EMX
TL850A	037103592996	Temperature key	1	White	850	
TL600B	037103593009	Temperature key	1	Yellow	600	ETZ, ETM, ETR, ETU
TL650B	037103592972	Temperature key	1	Yellow	650	EMC, EMD, EME, EMF, EMG, EMY
TL700B	037103592989	Temperature key	1	Yellow	700	EPH105, EPH106, EPH111
TL750B	037103592897	Temperature key	1	Yellow	750	SMT89J, SMT8K
TL800B	037103592903	Temperature key	1	Yellow	800	SMT0504A, SMT0805B, SMT1005C
TL850B	037103592958	Temperature key	1	Yellow	850	SMT1206D, SMT1808F, SMT80M, SMT2E
TL600C	037103592965	Temperature key	1	Red	600	ETJ, ETK, ETO, ETS, ETT
TL650C	037103592934	Temperature key	1	Red	650	ETY
TL700C	037103592941	Temperature key	1	Red	700	SMT1505E, SMT1825G, SMT14L
TL750C	037103592873	Temperature key	1	Red	750	
TL800C	037103592880	Temperature key	1	Red	800	
TL850C	037103592859	Temperature key	1	Red	850	



Station No.: **WTL10001**  
**EC1201A** 40w iron w/ETA tip & stand.  
 Tips listed on page Weller 57.



Station No.: **WTL10002**  
**EC1302A** 20w iron w/EPH101 tip & stand.  
 Tips listed on page Weller 60.



Station No.: **WTL10003**  
**EC1503A** 42w iron w/EMAtip & stand.  
 Tips listed on page Weller 61.

# DEC1001



ESD SAFE



- Combined power of two temperature controlled stations in one
- Dual dial temperature range of 350°F to 850°F
- Ideal for multiple use situations-Power unit output: 24VAC
- For use with 40, 20 or 42 watt irons combining any two at a time. IRONS SOLD SEPARATELY
- Electrostatic discharge safe (ESD safe)
- Two iron stands included with tip storage, positions left, right or remote from main unit
- Water reservoir keeps sponge moist
- SPEC. COMPLIANCE - DOD-STD-2000, Mil-STD-2000, Mil-S-45743, W-S-6536, W-S-570 and DOD-STD-1686
- DEC1001 Comes with stand no. PH1201ESD & PH1301 ESD
- Unit allows calibration by user
- Externally fused
- See iron fume extraction adapter kit table on page Weller 27
- UL listed

Cat. No.	UPC No.	Description	V	W	Hz	Shelf Pack Wt.		Shelf Pack
						lb	kg	
DEC1001	037103593030	Dual iron power unit w/two iron stands	120	120	60	3.75	1.69	1



Station No.: **DEC1000**



- Combines power of two temperature controlled stations in one
- Tip temperature for both irons controlled by Thermolock® “keys” not adjustable by the operator - PROVIDES OPERATOR LOCKOUT
- To change tip temperature, replace one “key” with another “key” marked with a different temperature
- Tip temperature controls to within ±10°F with inserted Thermolock® “key”
- Electrostatic discharge safe (ESD safe)
- Safety feature powers irons down to 350°F if “key” is removed while unit is on
- Ideal for multiple use situations - Power unit output 24VAC
- For use with 40, 20, 42 watt irons, combining any two at a time - **IRONS SOLD SEPARATELY**
- DTL1000 comes with stand no. PH1201ESD and PH1301ESD
- SPEC. COMPLIANCE: DOD-STD-2000, Mil-STD-2000, W-S-6536, W-S-570 and DOD-STD-1686
- Unit allows calibration by user
- Externally fused
- See iron fume extraction adapter kit table on page Weller 27
- UL listed
- 2 ea. of 700°F, 750°F, 800°F temperature keys included



Cat. No.	UPC No.	Description	V	W	Hz	Shelf Pack Wt.		Shelf Pack
						lb	kg	
DTL1000	037103028174	Dual iron power unit w/two iron stands	120	120	60	3.75	1.69	1

Cat. No.	UPC No.	Description	Shelf Pack	Color Code	Temp °F	For Soldering Tip Style
TL600A	037103593252	Temperature key	1	White	600	ETA, ETAA, ETB, ETBB, ETC, ETCC
TL650A	037103593016	Temperature key	1	White	650	ETD, ETDD, ETH, ETP
TL700A	037103593023	Temperature key	1	White	700	EPH101, EPH102, EPH103, EPH104
TL750A	037103592910	Temperature key	1	White	750	EPH107, EPH108, EPH109, EPH110
TL800A	037103592927	Temperature key	1	White	800	EMA, EMB, EMH, EMX
TL850A	037103592996	Temperature key	1	White	850	
TL600B	037103593009	Temperature key	1	Yellow	600	ETZ, ETM, ETR, ETU
TL650B	037103592972	Temperature key	1	Yellow	650	EMC, EMD, EME, EMF, EMG, EMY
TL700B	037103592989	Temperature key	1	Yellow	700	EPH105, EPH106, EPH111
TL750B	037103592897	Temperature key	1	Yellow	750	SMT89J, SMT8K
TL800B	037103592903	Temperature key	1	Yellow	800	SMT0504A, SMT0805B, SMT1005C
TL850B	037103592958	Temperature key	1	Yellow	850	SMT1206D, SMT1808F, SMT80M, SMT2E
TL600C	037103592965	Temperature key	1	Red	600	ETJ, ETK, ETO, ETS, ETT
TL650C	037103592934	Temperature key	1	Red	650	ETY
TL700C	037103592941	Temperature key	1	Red	700	SMT1505E, SMT1825G, SMT14L
TL750C	037103592873	Temperature key	1	Red	750	
TL800C	037103592880	Temperature key	1	Red	800	
TL850C	037103592859	Temperature key	1	Red	850	



Station No.: **DTL1000**



# Irons for Electronically Controlled soldering stations

## EC1201A

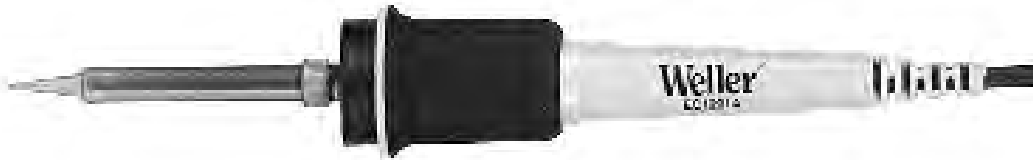

- General purpose soldering tool
- Specifically designed for use at electrostatic discharge free work stations
- Completely free from stored static charges (ESD safe)
- Stainless steel plug-in heater element construction
- Non-burnable silicon rubber cord
- Lightweight, high impact plastic handle
- Blue plastic meets requirements for ESD, ELECTROSTATIC DISSIPATIVE MATERIALS
- Weller station and iron combination meets: DOD-STD-2000, Mil-STD-2000, Mil-S-45743, W-S-570 and DOD-STD-1686
- Uses Weller ET and SMT series tips made of copper w/heavy iron, nickel and chromium plating for long life
- IMPORTANT: Use only Weller tips
- ET series tips on page Weller 57
- SMT series tips on page Weller 66
- See iron fume extraction adapter kit table on page Weller 27
- UL listed

Cat. No.	UPC No.	Description	V	W	Hz	Shelf Pack Wt.		Shelf Pack
						lb	kg	
EC1201A	037103593795	40w soldering iron w/ETA tip	24	40	-	0.37	0.16	1
<b>Replacement parts</b>								
EC234	037103479747	Heater assembly for EC1201A				-		1
EC229A	037103594044	Sensor assembly for EC1201A				-		1



Catalog No.: **PH1201ESD**  
Iron stand assembly



Catalog No.: **TC204**  
Spring and funnel assembly



Catalog No.: **TC205**  
Sponge



- Micro-soldering tool
- Specifically designed for use at electrostatic free work stations
- Completely free from stored static charges (ESD safe)
- Stainless steel heater element construction
- Non-burnable silicon rubber cord
- Lightweight, high impact plastic handle
- Blue plastic meets requirements for ESD, ELECTROSTATIC DISSIPATIVE MATERIALS
- Weller station and iron combination meets: DOD-STD-2000, Mil-STD-2000, Mil-S-45743, W-S-6536, W-S-570 and DOD-STD-1686
- Uses Weller EPH series tips made of copper w/heavy iron, nickel and chromium plating for long life
- IMPORTANT: Use only Weller tips
- EPH series tips on page Weller 60
- See iron fume extraction adapter kit table on page Weller 27
- UL listed

Cat. No.	UPC No.	Description	V	W	Hz	Shelf Pack Wt.		Shelf Pack
						lb	kg	
EC1302A	037103593290	20w iron w/EPH101 tip	24	20	-	0.31	0.14	1
<b>Replacement parts</b>								
EC259	037103032478	Heater assembly for EC1302A				-		1
EC260	037103032485	Sensor assembly for EC1302A				-		1



Catalog No.: **PH1301ESD**  
Iron stand assembly



Catalog No.: **IHF225EC**  
Spring and funnel assembly



Catalog No.: **TC205**  
Sponge

# EC1503A



- Tool designed for difficult applications such as multilayer boards, large heat output from small tool
- Specifically designed for use at electrostatic free work stations
- Completely free from static charges (ESD safe)
- Non-burnable silicon rubber cord
- Lightweight, high impact plastic handle
- Blue plastic meets requirements for ESD, ELECTROSTATIC DISSIPATIVE MATERIALS
- High mass EM series tips manufactured w/taper fit to match iron heater sheath providing max. heat transfer from heater to tip. 14 tip shapes available
- Weller station and iron combination meets: DOD-STD-2000, Mil-STD-2000, Mil-S-45743, W-S-6536, W-S-570 and DOD-STD-1686
- Uses Weller EM series tips made of copper w/heavy iron, nickel and chromium plating for long life
- IMPORTANT: Use only Weller tips
- EM series tips on page Weller 61
- See iron fume extraction adapter kit table on page Weller 27
- UL listed

Cat. No.	UPC No.	Description	V	W	Hz	Shelf Pack Wt.		Shelf Pack
						lb	kg	
EC1503A	037103593283	42w soldering iron w/EMAtip	24	42	-	0.31	0.14	1
<b>Replacement parts</b>								
EC262	037103032461	Heater assembly for EC1503A				-		1
EC263	037103032447	Sensor assembly for EC1503A				-		1



Catalog No.: **PH1503**  
Iron stand assembly



Catalog No.: **EC254**  
Spring and funnel assembly



Catalog No.: **TC205**  
Sponge

# Weller/Unger electronic soldering system 921ZX1

Weller®



ESD SAFE

- Electronically controlled - zero cross circuitry
- Spike free - ESD safe
- Ceramic heater rated for exceptionally long life
- Variable control - fully adjustable 550° - 850°F
- Lightweight hand piece
- Over 39 tips available including SMT tips
- External fuse and calibration access
- Temperature lockout available
- Small footprint requires little bench space
- Mil-STD compliant
- Replace tips listed on page Unger 20 (9000 series)
- UL listed



Cat. No.	UPC No.	Description	V	W	Hz	Shelf Pack Wt.		Shelf Pack
						lb	kg	
921ZX1	037103089281	Soldering station/9018 tip	120	60*	60	3.7	1.68	1
<b>The following is available only to authorized export distributors. Units not VDE or GS approved.</b>								
921ZX1D	037103095114	Soldering station/9018 tip	230	60*	50/60	3.7	1.68	1

\* Handle wattage is rated at full load. Idle wattage is approximately 20 watts.

Cat. No.	UPC No.	Description	Shelf Pack Wt.		Shelf Pack
			lb	kg	
9904	037103035455	Replacement sponge	0.01	0.005	10
2115	037103031624	Temperature lockout kit	0.075	0.034	1
9908	037103035486	Replacement heating element	0.027	0.012	1
9037	037103035042	Tip retainer assembly for standard tips	0.03	0.014	1
9919	037103035578	Tip retainer assembly for thermal thrust tips	0.03	0.014	1
4618	037103063434	Tip adapter for Weller® SMT tips	0.02	0.009	2



Catalog No.: **9211**  
Iron for 921ZX1 w/9018 tip



Catalog No.: **9904**  
Sponge for 921ZX1

# Controlled-output soldering station WTCPT



- Transformer powered soldering station complete w/macro style, low voltage, temperature controlled soldering iron
- Special “closed loop” method of controlling maximum tip temperature... to protect temperature sensitive components
- Power unit housing features impact resistant plastic for durability
- Quick disconnect plug for soldering iron and lighted on/off switch
- Separate conductor grounds iron tip and terminates at third pin of power cord
- PT series soldering tips come in a variety of shapes and sizes in three standard temperature ranges: 600°F, 700°F and 800°F. Optional temperatures for special order 500°F and 900°F
- PT series tips listed on page Weller 62
- See iron fume extraction adapter kit table on page Weller 27
- UL listed

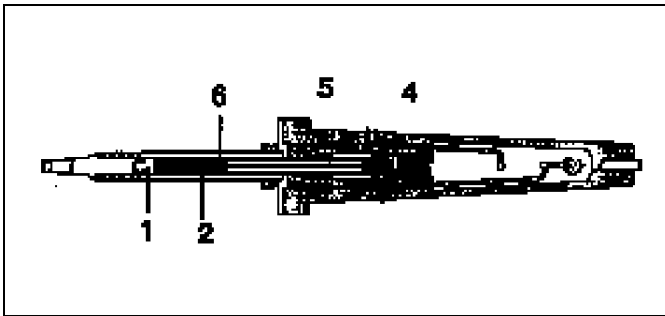

When the soldering tip is cold, a ferromagnetic temperature sensor (1) attached to the tip attracts a permanent magnet (2). The magnet movement causes a shorting bar (3) to make contact with a set of isolated electrical contacts (4) thereby supplying power to the heating element through the solder lugs (5). When the tip reaches its idle temperature, the sensor becomes non-magnetic and no longer attracts the magnet. Then a magnetic bushing (6) attracts the magnet causing the shorting bar to break the circuit. In this manner, power to the heating element is turned on and off automatically.

Cat. No.	UPC No.	Description	V	W	Hz	Shelf Pack Wt.		Shelf Pack
						lb	kg	
WTCPT	037103001146	Complete station-24V Output	120	60	60	4.00	1.80	1
TC201T	037103001153	Soldering iron	24	42		0.31	0.14	1
<b>The following is available only to authorized export distributors. Units not VDE or GS approved.</b>								
WTCPTD	037103001122	Complete station	240	60	50/60	4.00	1.80	1
<b>Replacement parts</b>								
EC234	037103479747	Heater assembly for TC201T						1
SW60	037103474040	Switch assembly for TC201T						1

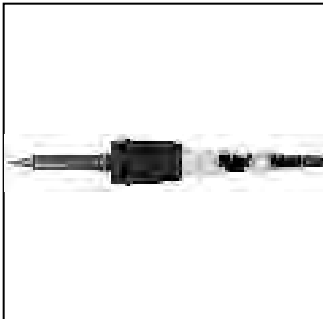

Catalog No.: **TC201T**  
42w iron w/PTA7 tip



Catalog No.: **PH1201ESD**  
ESD Iron stand assembly



Catalog No.: **TC204**  
Spring and funnel assembly



Catalog No.: **TC205**  
Sponge



## Stained glass station WLC200

- On/off switch with “power-on” indicator light
- Variable power control produces 5-80 watts
- Quality lightweight stained glass iron
- Cushioned foam grip with replaceable heating element
- Ideal for the professional or hobbyist
- Safety guard iron holder
- Natural sponge tip cleaning pad
- 3/8 in. replaceable tip
- Operates with MTG20, MTG21 MTG22 tips, see page Weller 68
- See iron fume extraction adapter kit table on page Weller 27
- UL listed



Cat. No.	UPC No.	Description	V	W	Hz	Shelf Pack Wt.		Shelf Pack
						lb	kg	
WLC200	037103085030	Complete station w/80w iron	120	80	60	2.5	1.13	1

## Controlled-output soldering irons W60P series irons



- Line voltage high quality portable tool... controlled output and temperature
- Weller “closed loop” method of controlling max. tip temperature protects temperature sensitive components
- Iron features stainless steel modular plug-in heater construction for greater soldering efficiency
- Nominal heat-up time w/CT5A7 tip = 110 seconds
- Includes CT5A7, 700°F 1/16” dia. screwdriver tip
- Also available with 3-wire grounded cord set
- **IMPORTANT:** Use only Weller tips
- CT5 series tips listed on page Weller 63
- See iron fume extraction adapter kit table on page Weller 27
- UL listed

Cat. No.	UPC No.	Description	V	W	Hz	Shelf Pack Wt.		Shelf Pack
						lb	kg	
W60P	037103474087	Soldering iron w/CT5A7 tip	120	60	50/60	4.00	1.80	6
W60P3	037103474094	Same as W60P but w/3-wire cord	120	60	50/60	4.00	1.80	6

**The following is available only to authorized export distributors. Units not VDE or GS approved.**

W60PD	037103477811	Soldering iron	240	60	50/60	4.00	1.80	6
W60PD3	037103593962	Soldering iron 3-wire cord	240	60	50/60	4.00	1.80	6

### Replacement parts

HEW60P	037103480064	Heater assembly for W60P				-		1
HEW60PD	037103593337	Heater assembly for W60PD				-		1
SW60	037103474070	Switch assembly for W60P series				-		1
KN60A	037103474001	Knurled tip nut for W60P series				-		1



Catalog No.: **PH60**  
Soldering iron stand assembly



Catalog No.: **SFA60**  
Spring and funnel assembly



Catalog No.: **TC205**  
Sponge

## W100PG series irons



- Line voltage high quality portable tool... controlled output and temperature
- Weller “closed loop” method of controlling max. tip temperature protects temperature sensitive components
- Iron features stainless steel modular plug-in heater construction for greater soldering efficiency
- Nominal heat-up time w/CT6F7 tip = 110 seconds
- Comes with CT6F7, 700°F, 1/4” dia. screwdriver tip
- Also available with 3-wire grounded cord set
- IMPORTANT: Use only Weller tips
- CT6 series tips listed on page Weller 63
- See iron fume extraction adapter kit table on page Weller 27
- UL listed

Cat. No.	UPC No.	Description	V	W	Hz	Shelf Pack Wt.		Shelf Pack
						lb	kg	
W100PG	037103474261	Soldering iron w/CT6F7 tip	120	100	50/60	4.75	2.14	6
W100P3	037103474278	Same as W100PG but w/3-wire cord	120	100	50/60	4.75	2.14	6
<b>The following is available only to authorized export distributors. Units not VDE or GS approved.</b>								
W100PD3	037103593979	Soldering iron 3-wire cord	240	100	50/60	4.75	2.14	6
<b>Replacement parts</b>								
HEW100P	037103480071	Heater assembly for W100P				-		1
HEW100PD	037103593344	Heater assembly for W100PD				-		1
SW60	037103474070	Switch assembly for W100PG series				-		1
KN100A	037103474186	Knurled tip nut for W100PG series				-		1



Catalog No.: **PH100**  
Soldering iron stand assembly



Catalog No.: **SFA100**  
Spring and funnel assembly



Catalog No.: **TC205**  
Sponge

# Professional soldering irons WP25, WP30, WP35 series irons

Weller®



- Ideal for a wide variety of electronic tasks
- Interchangeable heater elements - single handle plus three different heating elements gives the user a trio of irons for different jobs
- Quick change knurled collar makes changing heater simple
- Lightweight handle with cushioned grip
- For additional safety, all irons come with 3-wire power cord
- Irons use ST series iron plated tips for long life and greater soldering efficiency
- **IMPORTANT:** Use only Weller tips
- ST series tips listed on page Weller 63
- See iron fume extraction adapter kit table on page Weller 27
- UL listed

Cat. No.	UPC No.	Description	V	W	Hz	Shelf Pack Wt.		Shelf Pack
						lb	kg	
WP25	037103593597	Soldering iron w/ST3 tip	120	25	50/60	2.50	1.13	6
WP30	037103593603	Soldering iron w/ST3 tip	120	30	50/60	2.50	1.13	6
WP35	037103593610	Soldering iron w/ST3 tip	120	35	50/60	2.50	1.13	6
<b>Replacement parts</b>								
HE25	037103593627	25w replacement heater				-		1
HE30	037103593634	30w replacement heater				-		1
HE35	037103593641	35w replacement heater				-		1
<b>The following is available only to authorized export distributors. Units not VDE or GS approved.</b>								
WP25D	037103000309	Soldering iron	220	25	50/60	2.50	1.13	6
WP30D	037103024640	Soldering iron	220	30	50/60	2.50	1.13	6
WP35D	037103003584	Soldering iron	220	35	50/60	2.50	1.13	6
HE25D	037103001337	25w replacement heater				-		1
HE30D	037103024664	30w replacement heater				-		1
HE35D	037103024633	35w replacement heater				-		1



Catalog No.: **HE25/HE30/HE35**  
Replacement heater



Catalog No.: **PH60**  
Iron stand assembly



Catalog No.: **SFA60**  
Spring and funnel assembly



Catalog No.: **TC205**  
Sponge

# Weller Pro Plus™ Series soldering irons WP40S, WP60S, WP100S, WP60H



WP60S



WP60H

- Plug-in heating element changes quickly and easily reducing downtime and increasing productivity
- Wide selection of tips in different sizes and styles
- Easy-to-replace, long-lasting iron-plated tips
- Comfortable cushioned-grip handle stays cool
- 3-wire grounded plug
- All tips ordered separately. See page Weller 64
- UL listed

Cat. No.	UPC No.	Description	V	W	Hz	Shelf Pack Wt.		Shelf Pack
						lb	kg	
<b>Pro Plus™ Series Soldering Irons</b>								
WP40S	037103110718	40-watt iron without tip - Straight	120	40	50/60	2.80	1.27	6
WP60S	037103110879	60-watt iron without tip - Straight	120	60	50/60	2.80	1.27	6
WP60H	037103110749	60-watt iron without tip - Hatchet	120	60	50/60	2.80	1.27	6
WP100S	037103110855	100-watt iron without tip - Straight	120	100	50/60	2.80	1.27	6
<b>Pro Plus™ Series Heating Elements</b>								
WP40SMOD	037103110916	Straight 40-watt Plug-in Heater w/o tip	-	40	-	1.22	.55	6
WP60SMOD	037103110930	Straight 60-watt Plug-in Heater w/o tip	-	60	-	1.22	.55	6
WP60HMOD	037103110770	Hatchet 60-watt Plug-in Heater w/o tip	-	60	-	1.22	.55	6
WP100SMOD	037103110787	Straight 100-watt Plug-in Heater w/o tip	-	100	-	1.22	.55	6

## WM120 pencil thin soldering iron



- Lightweight, pencil thin soldering iron with stay-cool handle
- Designed for soldering miniature components
- Develops tip temperature of 800°F (427°C)
- 3 wire grounded plug
- Uses Weller MP series auto slide-in tips
- IMPORTANT: Use only Weller tips
- MP series tips listed on page Weller 65
- UL listed

Cat. No.	UPC No.	Description	V	W	Hz	Shelf Pack Wt.		Shelf Pack
						lb	kg	
WM120	037103477118	Miniature soldering iron	120	12	50/60	3.00	1.35	6



Catalog No.: **PH1301ESD**  
Iron stand assembly



Catalog No.: **IHF225EC**  
Spring and funnel assembly



Catalog No.: **TC205**  
Sponge

## Temtronic soldering pencil Peritronic MPR30



- Operation of soldering tip adjusts continuously up to 40° of angle by loosening lock screw
- Unobstructed view of work area meets individual needs of each operator
- Screw knurl fastens tip and barrel
- Temperature sensor placed in center of tip
- Heater located inside tip for high efficiency
- 5-wire silicone cord
- Use with any "EC" station
- MPT series tips listed on page Weller 65

Cat. No.	UPC No.	Description	V	W	Hz	Shelf Pack Wt.		Shelf Pack
						lb	kg	
MPR30	037103043696	Temtronic soldering pencil w/stand	24	30	60	2.50	1.13	1
KH25P	037103049179	Iron stand assembly (packed w/iron)	-	-	-	-	-	1



Catalog No.: **KH25P**  
Iron stand assembly



## Marksman® soldering irons SP12 Mini iron (12 watt)



- Fine quality mini iron
- Produces 12 watts
- 7 in./178 mm long
- Lightweight and pencil thin
- Ideal for fine soldering and hobby work such as electronic kits, model railways and jewelry making
- Replaceable nickel-plated copper tip see page Weller 68
- Stainless steel barrel
- Heat and impact resistant handle
- UL Listed

Cat No.	UPC No.	Description	V	W	Hz	Pack Wt.		Shelf Pack
						lb	kg	
SP12	037103479716	Soldering iron	120	12	50/60	3	1.36	6

## SP23 Iron (25 watt)



- Fine quality iron
- Produces 25 watts
- 8-1/4 in./210 mm long
- Featherweight iron with pencil handle
- Ideal for hobbies, kits and radios
- MT1 1/8 in./3 mm diameter replaceable nickel-plated copper tip see page Weller 68
- Develops 750°F/400°C
- Stainless steel barrel
- Heat and impact resistant handle
- UL Listed

Cat No.	UPC No.	Description	V	W	Hz	Pack Wt.		Shelf Pack
						lb	kg	
SP23	037103473684	Soldering iron	120	25	50/60	5 <sup>1</sup> / <sub>8</sub>	2.5	6

The following is available only to authorized export distributors. Units not VDE or GS Approved.

SP25D	037103475909	Soldering iron	220/240	25	50/60	5 <sup>1</sup> / <sub>8</sub>	2.5	12
-------	--------------	----------------	---------	----	-------	-------------------------------	-----	----

## SP40 iron (40 watt)



- Fine quality iron
- Produces 40 watts
- 8-1/4 in./210 mm long
- Lightweight pencil iron
- Ideal for hobby and electronic work
- MT10 1/4 in./10 mm diameter replaceable nickel-plated copper tip see page Weller 68
- Develops 900°F/482°C
- Stainless steel barrel
- Heat and impact resistant handle
- UL Listed

Cat No.	UPC No.	Description	V	W	Hz	Pack Wt.		Shelf Pack
						lb	kg	
SP40	037103473875	Soldering iron	120	40	50/60	2 <sup>1</sup> / <sub>4</sub>	1.2	6

The following is available only to authorized export distributors. Units not VDE or GS Approved.

SP40D	037103475923	Soldering iron	220/240	40	50/60	2	.9	6
-------	--------------	----------------	---------	----	-------	---	----	---

## SP80 Iron (80 watt)

- Fine quality, medium-duty iron produces 80 watts
- 9-3/4 in./247 mm long
- Ideal for hobby work, stained glass and minor repairs
- Soldering iron rest included
- MT20 3/8 in./10 mm diameter replaceable nickel-plated copper tip see page Weller 68
- Develops 900°F/482°C
- Stainless steel barrel
- Heat and impact resistant handle
- UL Listed



Cat No.	UPC No.	Description	V	W	Hz	Pack Wt.		Shelf Pack
						lb	kg	
SP80	037103474131	Soldering iron	120	80	50/60	3	1.36	6

**The following is available only to authorized export distributors. Units not VDE or GS approved.**

SP80D	037103475930	Soldering iron	220/240	80	50/60	2 <sup>3</sup> / <sub>4</sub>	1.25	6
-------	--------------	----------------	---------	----	-------	-------------------------------	------	---

## SP120 Iron (120 Watt)

- Fine quality iron
- Produces 120 watts
- 11-3/8 in./289 mm long
- Ideal for home workshop, repairs, stained glass and hobbies
- Soldering iron rest included
- MTG30 1/2 in./13 mm diameter replaceable iron-plated copper tip
- Develops 900°F/482°C
- Stainless steel barrel
- Heat and impact resistant handle
- IMPORTANT: Use only Weller® tips. Use of non-Weller components may void product warranty if the non-Weller component causes damage to the unit.
- MTG series tips listed on page Weller 68
- UL listed



Cat. No.	UPC No.	Description	V	W	Hz	Shelf Pack Wt.		Shelf Pack
						lb	kg	
SP120	037103474537	Soldering iron	120	120	50/60	3.50	1.58	3

**The following is available only to authorized export distributors. Units not VDE or GS approved.**

SP120D	037103590305	Soldering iron	240	120	50/60	3.50	1.58	3
--------	--------------	----------------	-----	-----	-------	------	------	---

## SP175 Iron (175 Watt)

- Fine quality iron
- Produces 175 watts
- 12-1/2 in./318 mm long
- Extra heavy-duty for demanding jobs like sheet metal work
- Soldering iron rest included
- MTG40 5/8 in./16 mm diameter replaceable iron-plated copper tip
- Develops 900°F/482°C
- Stainless steel barrel
- Heat and impact resistant handle
- IMPORTANT: Use only Weller® tips. Use of non-Weller components may void product warranty if the non-Weller component causes damage to the unit
- MTG series tips listed on page Weller 68
- UL listed



Cat. No.	UPC No.	Description	V	W	Hz	Shelf Pack Wt.		Shelf Pack
						lb	kg	
SP175	037103474674	Soldering iron	120	175	50/60	4.00	1.80	3

**The following is available only to authorized export distributors. Units not VDE or GS approved.**

SP175D	037103590299	Soldering iron	240	175	50/60	4.00	1.80	3
--------	--------------	----------------	-----	-----	-------	------	------	---

## Cordless soldering tools WSTA3 Pyropen®



- Lightweight and completely portable
- Ready to use in 30 seconds
- Ideal for field service jobs
- Sturdy metal tank holds enough gas for three hours of operation
- Does not require cords, batteries or cartridges
- Temperature adjusts from 392°F-932°F/200°C-500°C
- 14 tip combinations available
- Inactive hot air nozzles for low temperature heat are available
- Refills with butane lighter gas - Weller cat. no. WB1
- WPT series tips listed on page Weller 69

Cat. No.	UPC No.	Description	Shelf Pack Wt.		Shelf Pack
			lb	kg	
WSTA3	037103472281	Cordless soldering iron	1	.45	3

Replacement parts: See replacement parts book

## WPA2 Self Igniting Pyropen®



- Ignites with the push of a button
- Lightweight and completely portable
- Ready to use in 30 seconds
- Ideal for field service jobs
- Sturdy metal tank holds enough gas for three hours of operation
- Does not require cords, batteries or cartridges
- Temperature adjusts from 482°F-932°F/250°C-500°C
- 14 soldering tip combinations available
- Inactive hot air nozzles for low temperature heat (1202°F/650°C) are available
- Refills with butane lighter gas - Weller cat. no. WB1
- All temperatures are approximate
- WPT series tips listed on page Weller 69

Cat. No.	UPC No.	Description	Shelf Pack Wt.		Shelf Pack
			lb	kg	
WPA2	037103590435	Self-igniting cordless soldering iron	0.50	0.22	1
WPAPC	037103590442	Pyropen plastic cap	0.13	0.06	1
WPAE	037103590459	Pyropen ejector	0.06	0.02	1
WPAB	037103590466	Pyropen burner	0.07	0.03	1
WPACN	037103590480	Pyropen cap nut	0.05	0.02	1

## WST2 Pyropen® Jr



- Lightweight mini iron
- Does not require cords, batteries or cartridges
- Dual function soldering iron and brazing torch
- Temperature control
- Soldering iron: 392°F-842°F/200°C-450°C; hotblow feature: 806°F /430°C maximum; torch feature: 2372°F /1300°C maximum
- Long life soldering tips heat quickly
- Refills with butane lighter gas - Weller cat. no. WB1
- All temperatures are approximate
- WPT series tips listed on page Weller 70

Cat. No.	UPC No.	Description	Shelf Pack Wt.		Shelf Pack
			lb	kg	
WST2	037103477514	Cordless soldering iron	0.50	0.22	1

Replacement parts: See replacement parts book

## PSI100 Portasol®

- Self-igniting portable butane heat tool
- Allows anti-static soldering
- Features “Auto Switch” safety shut-off, iron plated tips, and built-in filter
- Rugged stainless-steel body provides up to 125 watts of power
- Adjustable temperature up to 1,076°F
- Fuel level is clearly visible through a window on the body of the tool
- Refills with butane lighter gas – Weller cat no. WB1
- PS series tips listed on page Weller 70



Cat. No.	UPC No.	Packed	Description	Pack Wt.		Shelf Pack
				lb	kg	
PSI100	037103060969	Boxed	Portasol Cordless, refillable butane gas-powered soldering tool.	.3	.14	1
PSI100C	037103127174	Carded	Portasol Cordless, refillable butane gas-powered soldering tool.	.3	.14	1

Portasol® is a registered trademark of Oglesby and Butler Limited.

## PSI100K Portasol® Kit

- Professional quality Portasol® heat tool
- Ideal for service technicians to solder, heat shrink and cut rope
- Butane fuel level is visible through a window on the body of the tool
- Built-in fuel filter reduces contaminated fuel problems
- Auto switch safety shut off on cap
- Operates up to 2 hours per refill
- Temperature is fully adjustable
- Maximum temperature of 1076°F/580°C
- Kit contains PSI100 iron, sponge, stand and extra tips packed in a plastic case
- PS series tips listed on page Weller 70



Cat. No.	UPC No.	Packed	Description	Shelf Pack Wt.		Shelf Pack
				lb	kg	
PSI100K	037103060976	Boxed	Portasol Cordless, refillable butane gas-powered soldering tool kit.	1.30	0.59	1

Portasol® is a registered trademark of Oglesby and Butler Limited.

## P1 Portasol®

- Does not require cords, batteries or cartridges
- Patented soldering tool has a catalytic converter that provides a powerful yet safe flameless combustion
- Refills with butane lighter gas – Weller cat. no. WB1
- Tank holds gas for 90 minute operation
- Safety cut-off switch when cap replaced
- Flint-spark ignitor in cap
- Ideal for a wide variety of soldering and desoldering jobs at work or at home
- Adjustable temperature control regulates the power (the equivalent of 10-60 watts) to quickly heat the tip
- Develops 850°F/454°C
- Optional accessories convert the P-1 into a soldering iron, blow torch, hot blower and hot knife
- T series tips listed on page Weller 71



Cat. No.	UPC No.	Description	Shelf Pack Wt.		Shelf Pack
			lb	kg	
P1B	037103593351	Portasol® Cordless-refillable Butane gas powered soldering tool. Boxed	-	-	6
P1C	037103593368	Portasol® Cordless-refillable Butane gas powered soldering tool. Carded	-	-	6

Portasol® is a registered trademark of Oglesby and Butler Limited.

## P1 Portasol® Kit



- Does not require cords, batteries or cartridges
- Patented soldering tool has a catalytic converter that provides a powerful yet safe flameless combustion
- Refills with butane lighter gas - Weller cat. no. WB1 (not included)
- Ideal for a wide variety of soldering jobs at work or at home
- Develops 850°F/450°C
- Kit contains Portasol® P1 soldering tool, 3/32 in./2.4 mm iron-plated soldering tip, hot knife accessory, hot blower accessory, blow torch accessory, cleaning sponge and safety stand
- Packed in a rugged plastic case
- T series tips listed on page Weller 71

Cat. No.	UPC No.	Description	Shelf Pack Wt.		Shelf Pack
			lb	kg	
P1KB	037103593375	Portasol® Cordless-refillable Butane gas powered soldering tool kit. Boxed	2.5	1.13	4
P1KC	037103593382	Portasol® Cordless-refillable Butane gas powered soldering tool. Carded	2.6	1.18	4

Portasol® is a registered trademark of Olglesby and Butler Limited.

## C1C Portasol®



- Does not require cords, batteries or cartridges
- Patented soldering tool has a catalytic converter that provides a powerful yet safe flameless combustion
- Refills with butane lighter gas – Weller cat. no. WB1 (not included)
- Safety cut-off switch when cap replaced
- Sturdy plastic cap fits neatly on back of tool during use
- C2 soldering tip included see page Weller 71
- 3 easily interchangeable screw-in tips are available
- Lightweight black case fits comfortably in hand
- Kit contains C1C iron, sponge, stand and extra tips packed in a plastic case

Cat No.	UPC No.	Description	Pack Wt.		Shelf Pack
			lb	kg	
C1C	037103593696	Portasol Cordless refillable Butane gas powered soldering tool, carded	1.14	.52	6
C1KC	037103127402	Portasol Cordless Refillable Butane gas powered soldering tool kit, carded	1.95	.89	6

Portasol® is a registered trademark of Olglesby and Butler Limited.

## Premium butane fuel for Portasol® and Pyropen® irons



- Premium quality butane fuel
- Compatible with Weller® Portasol® and Weller® Pyropen® tools
- Weighs 2.1 oz/60 g
- Printed in English and Spanish with operating instructions on back of can

Cat No.	UPC No.	Packed	Description	Net Wt.		Pack Wt.		Shelf Pack
				oz	g	lb	kg	
WB1	037103060921	Boxed	Premium butane fuel	2.1	60	2.9	1.32	12
WB2	037103126917	Boxed	Premium butane fuel	1.0	28	1.4	0.60	12

Portasol® is a registered trademark of Olglesby and Butler Limited.





**WFE2P**

**Weller®**

- Efficient 4-stage, replaceable filter system removes 99.995% of contaminants up to 3 microns
- No external air source required
- Silent-running, maintenance-free rotary pump
- Compact size makes it convenient to use anywhere
- For use with FE Series soldering irons
- Fully portable



Cat No.	UPC No.	Description	Shelf Pack Wt.		Shelf Pack
			lb	kg	
WFE2P	037103126764	Self contained 2 person fume extractor, 120v	6.6	3.0	1



**WFE20**

- Efficient 4-stage, replaceable filter system removes 99.997% of contaminants up to 3 microns
- Silent-running, maintenance-free turbine
- Vacuum turbine protected with thermal and electrical fuse
- Accommodates up to 20 Weller fume extraction soldering irons, 5 directly to the unit (or up to 2 arm extractors)
- Washable filters for longer life
- Wheeled design for portability



Cat No.	UPC No.	Description	Shelf Pack Wt.		Shelf Pack
			lb	kg	
WFE20	037103127136	20 person fume extractor	121	55	1

# Airex fume extraction system

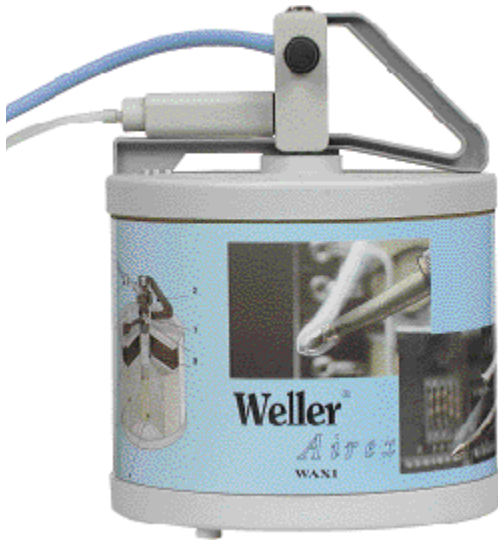

- 3-stage filter insures 99.97% filtration of particles
- Small space requirement allows convenient placement without disturbing surrounding work areas
- Connects to soldering irons with integral fume extraction or converted soldering irons with Clip-On Extractor Kit
- Easy to install, connects to compressed air supply (50-130PSI)
- Long service life
- Supports connection to exhaust air piping system
- Good value
- Low operating costs
- Quiet operation will not disturb surrounding work areas
- Includes 5'-0" extractor hose and 3'-0" compressed air hose
- Supports connection to soldering irons with twin-hose for cooling handle
- See iron fume extraction adapter kit table on page Weller 27

Cat. No.	UPC No.	Description	Working Pressure	Shelf Pack Wt.		Shelf Pack
				lb	kg	
WAX1	037103088161	Airex Fume extraction system	50 to 125 PSI	5.5	2.5	1
WAXK2	037103088505	Kit for connecting two soldering irons	-	0.10	0.05	1
<b>Replacement parts</b>						
WAXH1	037103088512	Replacement extractor hose - 5' long	-	0.10	0.05	1
WAXF1	037103088178	Replacement filter	-	5.0	2.23	1
WAXSF1	037103088536	Replacement silencer filter	-	0.010	0.004	1

## Soldering Stations with fume extraction irons EC10021FE, EC2002M1FE, WTCPTFE

- Three high quality precision soldering stations, each equipped with fume extraction iron
- ESD, impact resistant case protects sensitive components
- Adjustable 3/16" dia. stainless steel exhaust tube on iron for precise positioning over work
- 3/16" dia. x 7' length ESD safe tubing attaches to stainless steel exhaust tube and connects to fume extraction system
- Power Units: 120V; 60W; 60Hz
- See iron fume extraction adapter kit table on page Weller 27



Cat. No.	UPC No.	Description	Iron			Shelf Pack Wt.		Shelf Pack
			V	W	Hz	lb	kg	
EC10021FE	037103044556	EC1002-0 Power unit w/EC1201AFE Iron, ETA tip	24	42	60	4.00	1.80	1
EC2002M1FE	037103105837	EC2002M-0 power unit w/EC1201AFE iron, ETA tip	24	42	60	4.00	1.80	1
WTCPTFE	037103044549	PU120T Power unit w/TC201FE Iron, PTA7 tip	24	42	60	4.00	1.80	1



Catalog No.: **EC10021FE**  
EC1201AFE 42w iron w/ETA tip and stand.



Catalog No.: **WTCPTFE**  
TC201FE 42w iron w/PTA7 tip and stand.



Catalog No.: **PH1201FE**  
Iron stand assembly.



Catalog No.: **TC205**  
Sponge.

# Irons for fume extraction systems

## TC201FE



- Designed for use with Weller® or Airex® system
- Highly efficient and comfortable to use
- Adjustable 3/16" dia. stainless steel exhaust tube on iron for precise positioning over work
- 3/16" dia. x 7' length ESD safe tubing attaches to stainless steel exhaust tube
- Use with Weller® WTCP series stations and any Weller® Fume Extraction System
- PT series tips listed on page Weller 62
- See iron fume extraction adapter kit table on page Weller 27

Cat. No.	UPC No.	Description	V	W	Hz	Shelf Pack Wt.		Shelf Pack
						lb	kg	
TC201FE	037103592255	Soldering iron w/PTA7 tip	24	42	60	0.37	0.16	1
EC234FE	037103592279	Heater assembly for TC201FE	24	42	-	0.05	0.02	1
RTFE	037103592309	Replacement tubing - 7' clear	-	-	-	0.25	11.3	1



Catalog No.: **PH1201FE**  
Iron stand assembly



Catalog No.: **RSFFE**  
Spring and funnel assembly



Catalog No.: **TC205**  
Sponge

## EC1201AFE



- Designed for use with Weller® or Airex® Fume Extraction Systems
- Highly efficient and comfortable to use
- Adjustable 3/16" dia. stainless steel exhaust tube on iron for precise positioning over work
- 3/16" dia. x 7' length of ESD safe tubing connects to stainless steel exhaust tube
- Use with Weller EC1002-0, EC2002-0, MC5001-0, WTL1000-0, DEC1001 or DTL1000 power units
- ET series tips listed on page Weller 57
- See iron fume extraction adapter kit table on page Weller 27

Cat. No.	UPC No.	Description	V	W	Hz	Shelf Pack Wt.		Shelf Pack
						lb	kg	
EC1201AFE	037103001948	Soldering iron w/ETA tip	24	42	60	0.37	0.16	1
EC234FE	037103592279	Heater assembly for EC1201AFE	24	42	-	0.05	0.02	1
EC268	037103042231	Sensor assembly for EC1201AFE	-	-	-	0.05	0.02	1
WF1026	037103593542	Replacement tubing - 7' ESD	-	-	-	0.25	0.11	1



Catalog No.: **PH1201FE**  
Iron stand assembly



Catalog No.: **RSFFE**  
Spring and funnel assembly



Catalog No.: **TC205**  
Sponge

**WELLER® ADAPTER TABLE**  
**ADAPTER CATALOG NUMBER**

Manufacturer	Iron Model No.	[StationNo.]	AKFE1-1	AKFE2	AKFE3	AKFE4	AKFE5	AKFE6	ECMFE	MSFE	
<b>Weller®</b>	EC1201A		•								
	EC1201R		•								
	EC1302A								•		
	EC1302R								•		
	EC1503A								•		
	EC1503R								•		
		MT1500(L)									•
		SP23		•							
		SP40		•							
		SP80		•							
		SPG80		•							
		TC201T		•							
		TC201P		•							
		W100P		•							
		W100PG		•							
		W60P		•							
		WP25				•					
		WP30				•					
		WP35				•					
		WP25P		•							
		WP40P		•							
		WTL120		•							
			WCC100	•							
		WLC100	•								
		WLC200	•								
<b>Ungar®</b>	5550					•					
	555XR					•					
	555XT					•					
	7400					•					
	7500					•					
	9300							•			
	9910AS							•			
	9910HC							•			
	9911AS							•			
	9931AS			•							
	9941AS							•			
	SL325					•					
	SL335					•					
	SL345					•					
	SL500					•					

**WELLER® ADAPTER TABLE**  
**ADAPTER CATALOG NUMBER**

Manufacturer	Iron Model No.	[Station No.]	AKFE1-1	AKFE2	AKFE3	AKFE4	AKFE5	AKFE6	ECMFE	MSFE
<b>Ungar®</b>		2110				•				
		UTC100	•							
		UTC200						•		
		UTC300	•							
<b>Pace</b>	IR-70		•							
<b>Jensen</b>	47B723				•					
<b>Hexacon</b>		1002	•							
		1002PBS	•							
		HTC5500	•							
		HTC5600	•							
<b>Hakko</b>	900M			•						
	900L			•						
	900MESD			•						
	900LESD			•						
<b>Edsyn</b>	930	951					•			

**DS800 Electronically controlled desoldering station**



- High performance **internal rotary vane pump** delivers improved vacuum flow for quicker desoldering
- High mass head desoldering tool and tiplests aid in improved heat transference
- Ideal for multilayered boards
- Quality ESD construction... ESD safe
- Electronically controlled full range temperature selection (350°F - 850°F) assures fast response
- Convenient index finger push button controls the vacuum
- Tiplests listed on pages Weller 72 & 73
- Meets MIL SPECS:DOD-STD-2000, MIL-S-45743, Mil-STD-2000, W-S-6536, W-S-570, DOD-STD-1686, DOD-HDB-263
- UL listed

Cat. No.	UPC No.	Description	V	W	Hz	Shelf Pack Wt.		Shelf Pack
						lb	kg	
DS800	037103593207	Complete station-24v Output	120	150	60	11.50	5.20	1
DS1203A	037103086006	Desoldering tool	24	54	-	0.31	0.14	1
<b>The following is available only to authorized export distributors. Unit not VDE or GS approved.</b>								
DS800D	037103042217	Complete station-24v Output	220	150	50/60	11.50	5.20	1
<b>Replacement parts</b>								
DS219	037103104045	Desoldering head High Mass/threaded tiplests				-	-	1
DSH54	037103593191	Heater assembly for DS1203A				-	-	1
DS205	037103476531	In-line filter				-	-	10



Catalog No.: **DS2010**  
Desoldering iron stand assembly

## DS700M Electronically controlled desoldering station

- Product designed as technicians Portable unit (Intermittent use)
- Lightweight, compact electronic desoldering unit with **internal vacuum pump**
- Fingertip control of desoldering vacuum
- Special, large capacity air filter provided in power unit to back up small filter in tool's solder-collection reservoir
- Air output for low volume heat shrinking and other hot air jobs
- Lightweight desoldering tool with convenient index finger push button to control vacuum
- ESD safe
- SPEC. COMPLIANCE DOD-STD-2000-1, Mil-STD-2000
- Tiptets listed on page Weller 73
- UL listed



Cat. No.	UPC No.	Description	V	W	Hz	Shelf Pack Wt.		Shelf Pack
						lb	kg	
DS700M	037103480583	Complete station-24v Output	120	60	60	6.00	2.71	1
DS1201	037103480286	Desoldering tool	24	42	-	0.31	0.14	1

**The following is available only to authorized export distributors. Unit not VDE or GS approved.**

DS700MD	037103593931	Complete station	240	60	50/60	6.00	2.71	1
---------	--------------	------------------	-----	----	-------	------	------	---

### Replacement parts

DS229	037103104045	Desoldering head for tapered tiptets	-	-	-	-	-	1
EC234	037103479747	Heater assembly for DS1201	-	-	-	-	-	1
DS205	037103476531	In-line filter	-	-	-	-	-	10



Catalog No.: **DS1201**  
Desoldering iron

## DS600 Portable desoldering station

- **Self-contained vacuum system** requires 120 volt 60 Hz A.C. power source for operation
- Conveniently placed push button allows right or left handed operation
- Desoldering head temperature controlled to 700°F (371°C) included
- Carrying handle
- Power cord storage
- Built-in iron holder
- Tiptets listed on page Weller 72
- UL listed



Cat. No.	UPC No.	Description	V	W	Hz	Shelf Pack Wt.		Shelf Pack
						lb	kg	
DS600	037103478207	Complete station-24v Output	120	110	60	11.00	4.97	1
DS601P	037103478689	Desoldering tool	24	42	-	0.25	0.11	1

**The following is available only to authorized export distributors. Unit not VDE or GS approved.**

DS600D	037103005250	Complete station-24v Output	220	110	50/60	11.00	4.97	1
--------	--------------	-----------------------------	-----	-----	-------	-------	------	---

### Replacement parts

DS228	037103104069	Desoldering head for tapered tiptets (800°F)	-	-	-	-	-	1
EC234	037103479747	Heater assembly for DS601P	-	-	-	-	-	1
SW60	037103474070	Switch assembly for DS601P	-	-	-	-	-	1
DS205	037103476531	In-line filter	-	-	-	-	-	10



Catalog No.: **DS601P**  
Desoldering iron



# DS200 Electronically controlled desoldering/soldering station



DS200

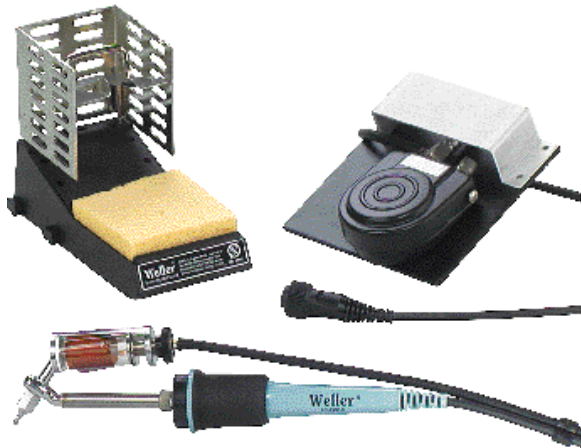

DS200K

- Electronically controlled, dual input soldering/ desoldering station ideal for limited space work areas
- Uses fast-responding **shop-air**, controlled with pneumatic foot-switch
- High-wattage for quicker thermal recovery
- Meets Mil SPEC. COMPLIANCE — DOD-STD-2000, Mil-S-2000, Mil-S-45743, W-S-6536, W-S-570 and DOD-STD-1686
- Low-cost, high-performance and flexibility to use any of the latest Weller irons (EC1201A, EC1302A, EC1503A)
- ET series tips listed on page Weller 57
- Tiplets listed on page Weller 72 & 73
- UL listed

Cat. No.	UPC No.	Description	V	W	Hz	Shelf Pack Wt.		Shelf Pack
						lb	kg	
DS200	037103024671	Soldering/Desoldering station w/EC1201A Soldering iron and DS1204A Desoldering Tool, Foot switch & stand	120	130	60	10.00	4.5	1
DS200K	037103024695	Desoldering kit w/DS1204A Desoldering Tool, Foot switch & stand	24	54	-	5.00	2.3	1
<b>The following is available only to authorized export distributors. Unit not VDE or GS approved.</b>								
DS200D	037103045911	Soldering/Desoldering station w/EC1201A Soldering iron and DS1204A Desoldering Tool, Foot switch & stand	240	130	50/60	10.00	4.5	1



# Weller® Temperature controlled rework stations

## WRS3000 rework station

Weller®

- **Self-contained**, ESD-safe station designed to handle all rework and repair of mixed technology boards
- Built-in microprocessor provides simultaneous controlled desoldering, soldering and hot air functions with complete accuracy and reliability
- Programmable temperature, hot air time and automatic temperature set-back
- Operator lock-out feature prevents any unauthorized changes
- Input watts: 300W; Timer set: 1-60 seconds
- Temperature range: Hot air 300°F - 980°F; Solder/Desolder 300°F - 850°F
- Temperature set-back: 5-60 minutes in 5 minute increments
- Compatible with Weller and Ungar soldering and desoldering irons



ESD SAFE



Cat. No.	UPC No.	Description	Power Unit			Shelf Pack Wt.		Shelf Pack
			V	W	Hz	lb	kg	
WRS3000	037103088642	Rework station-Output 24v	120	300	60	12.2	5.5	1

### Optional accessories:



Catalog No.: **EC1201AP**  
40W Soldering iron and stand  
ETA tip



Catalog No.: **EC1302AP**  
20W Soldering iron and stand  
EPH101 tip



Catalog No.: **EC1503AP**  
42W Soldering iron and stand  
EMAtip



Catalog No.: **DS1203AP**  
54W Desoldering tool and stand  
DSH112 tiptet



Catalog No.: **DS59**  
Desoldering pistol and stand  
4006 tiptet

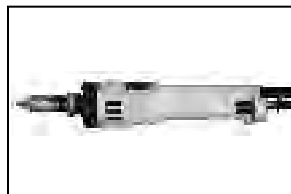

Catalog No.: **DS58**  
Desoldering pencil and stand  
- 4006 tiptet



Catalog No.: **WST20**  
Thermal stripper



Catalog No.: **HAP1**  
Hot air pencil and stand



Catalog No.: **9911AS**  
Micro-size iron - 24v,  
9012 tip

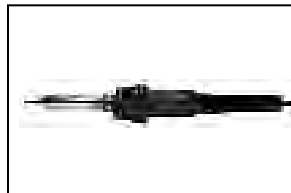

Catalog No.: **9931AS**  
Macro-size iron - 24v,  
9960 tip



Catalog No.: **WHPS**  
Preheat plate



Catalog No.: **WSS1**  
Stand system w/stands.  
Order iron holder and stands  
separately



Catalog No.: **FS1**  
Foot pedal



Catalog No.: **ADP1**  
Adapter for 9911AS, 9911HC,  
9931AS, 5088AS, 5098AS

# WRS2000 hot gas rework station



- Electronically controlled, ESD-safe hot gas rework station
- Multiple SMD functions in one unit:
  - Pick and place using vacuum pick-up
  - Dispensing of solder paste, flux, or adhesives
  - Soldering and desoldering of components
- Operates from inert gas or compressed air source
- All functions are activated with either hand or foot switch
- Compatible with Weller and Ungar soldering and desoldering irons
- Complete listing of nozzles for hot air pencil on page Weller 68
- Hot air pencil temperature control: 300°F - 1000°F
- Power supply: 145W
- Dimensions: 9.5" x 10.6" x 4.25"
- Current: 120V AC, 50-60 Hz
- Compressed air pressure required: 43.5 - 116.0 psi
- Hot air pencil: 100W
- Will accommodate optional Weller and Ungar soldering irons from 25 - 80W and desoldering irons from 50 - 80W

Cat. No.	UPC No.	Description	Shelf Pack Wt.		Shelf Pack
			lb	kg	
WRS2000	037103125460	Rework station with HAP1 hot air pencil, vacuum pick-up, dispensing, manual remote control, foot pedal, and stands	16	7.3	1

# WRS1000 rework station

Weller®



- **Self-contained**, ESD-safe station designed to handle variety of rework and repair tasks
- Selector switch allows user to choose either selection of tools below or standard hot air tool supplied
- Input watts: 175w
- Temperature range: Hot air 300°F - 1000°F; Solder/Desolder 300°F - 850°F
- Compatible with Weller and Ungar soldering and desoldering irons
- Complete listing of nozzles for hot air pencil on page Weller 68



Cat. No.	UPC No.	Description	Power Unit			Shelf Pack Wt.		Shelf Pack
			V	W	Hz	lb	kg	
WRS1000	037103088499	Rework station-Output 24v w/HAP1 Hot air pencil and stand	120	60	60	12.85	5.8	1

### Optional accessories:



Catalog No.: **EC1201AP**  
Soldering iron and stand  
ETA tip



Catalog No.: **EC1302AP**  
Soldering iron and stand  
EPH101 tip



Catalog No.: **EC1503AP**  
Soldering iron and stand  
EMA tip



Catalog No.: **DS1203AP**  
Desoldering tool and stand  
DSH112 tiptlet



Catalog No.: **DS59**  
Desoldering pistol and stand  
4006 tiptlet

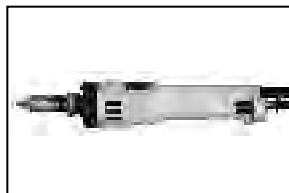

Catalog No.: **DS58**  
Desoldering pencil and stand  
- 4006 tiptlet



Catalog No.: **WST20**  
Thermal stripper



Catalog No.: **WSS1**  
Stand system w/stands.  
Order iron holder and stands  
separately



Catalog No.: **9911AS**  
Micro-size iron - 24v,  
9012 tip

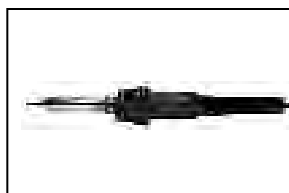

Catalog No.: **9931AS**  
Macro-size iron - 24v,  
9960 tip



Catalog No.: **WHPS**  
Preheat plate



Catalog No.: **ADP1**  
Adapter for 9911AS, 9911HC,  
9931AS, 5088AS, 5098AS



Catalog No.: **FS1**  
Foot pedal

# 4924 series rework stations



ESD SAFE



4924P

- **Self-contained**, ESD-safe rework station handles virtually all repair and rework applications, UL listed
- Temperature control for either of two anti-static desoldering handles; Temp. variation: 500°F - 850°F
- Temperature control for either one of two quick-connect 24VAC anti-static soldering irons; Temp, variation: 550°F - 850°F
- Desoldering vacuum switches to positive air flow for heat gun applications
- Power supply with three voltage ranges permits broad range use of optional tools
- Foot pedal switch or continuously powered machine center
- **#4924P** consists of: power base, 4310 machine center motor, 5098AS desoldering pistol, 9931AS macro soldering iron, 9911AS micro soldering iron, 8800 deluxe iron holder (shown)
- **#4924IL** same as #4924P but with 5088AS pencil-style desoldering iron in place of 5098AS pistol-style desoldering iron
- 4000 series tiptlets listed on page Weller 74

Cat. No.	UPC No.	Description	Power Unit			Shelf Pack Wt.		Shelf Pack
			V	W	Hz	lb	kg	
4924P	037103088611	Rework station-Output 24V	120	480	60	17.70	8.00	1
4924IL	037103088598	Rework station-Output 24V	120	480	60	17.70	8.00	1
<b>The following is available only to authorized export distributors. Units not VDE or GS approved.</b>								
4924PD	037103091871	Rework station-Output 24V	230	115	50/60	17.70	8.00	1
4924ILD	037103091888	Rework station-Output 24V	230	115	50/60	17.70	8.00	1

## Standard accessories:

For: 4924P, 4924IL

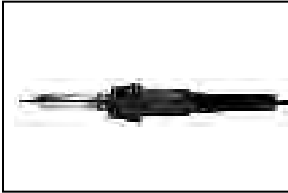

Catalog No.: **9931AS**  
Macro-size iron - 24v, 9960 tip

For: 4924P

For: 4924P, 4924IL



Catalog No.: **9911AS**  
Micro-size iron - 24v, 9012 tip

For: 4924IL



Catalog No.: **5098AS**  
Pistol-style desoldering tool - 24v, 4006 tiptlet

For: 4924P, 4924IL



Catalog No.: **5088AS**  
Pencil-style desoldering iron, 4006 tiptlet

For: 4924P, 4924IL



Catalog No.: **4310**  
Machine center motor for milling, drilling and grinding



Catalog No.: **8800**  
Iron holder assembly

## Optional accessories:

For: 4924P, 4924IL



Catalog No.: **2003**  
Foot pedal

For: 4924P, 4924IL



Catalog No.: **4912**  
Thermal wire stripper (large)

For: 4924P, 4924IL



Catalog No.: **4911**  
Accessory kit for 4310 motor

For: 4924P, 4924IL

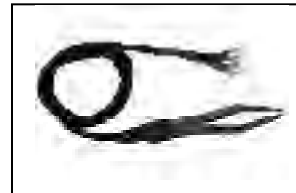

Catalog No.: **4913**  
Resistance soldering tweezers

# 4624 series rework stations



- **Self-contained**, ESD-safe soldering and desoldering system, UL listed and CUL-listed
- Operates either pencil or pistol-grip style desoldering handles. Temperature variation: 500°F - 850°F
- Also operates any one of two 24VAC quick-connect soldering irons. Temperature variation: 550°F - 850°F
- Rapid heat-up and vacuum response increases production (electronic repair, rework or modification)
- **#4624P** consists of: power base, 5098AS desoldering Pistol, 9931AS soldering iron, 400 sponge & tray (shown)
- **#4624IL** same as 4624P but with a 5088AS pencil-style desoldering iron in place of the 5098AS pistol-style desoldering iron
- SPEC. COMPLIANCE: MIL-STD-2000, DOD-STD-2000-1B, WS-6536E, MIL-S-46743E
- 4000 series tiptlets listed on page Weller 74



4624P

Cat. No.	UPC No.	Description	Power Unit			Shelf Pack Wt.		Shelf Pack
			V	W	Hz	lb	kg	
4624P	037103088628	Rework station-Output 24V	120	115	60	10.20	4.61	1
4624IL	037103088635	Rework station-Output 24V	120	115	60	10.20	4.61	1
<b>The following is available only to authorized export distributors. Units not VDE or GS approved.</b>								
4624PD	037103091895	Rework station-Output 24V	230	115	50/60	10.20	4.61	1
4624ILD	037103091901	Rework station-Output 24V	230	115	50/60	10.20	4.61	1

### Standard accessories:

For: 4624P, 4624IL

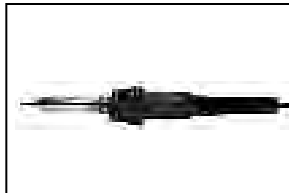

Catalog No.: **9931AS**  
Macro-size iron - 24v

For: 4624P



Catalog No.: **5098AS**  
Pisto-style desoldering iron,  
4006 tiptlet

For: 4624IL



Catalog No.: **5088AS**  
Pencil-style desoldering iron,  
4006 tiptlet

For: 4624P, 4624IL



Catalog No.: **400**  
Sponge and tray

### Optional accessories:

For: 4624P, 4624IL



Catalog No.: **9911AS**  
Micro-size iron - 24v,  
9012 tip



# 4024 series rework stations

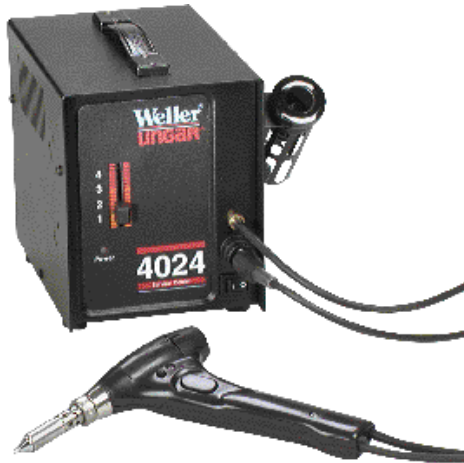

4024IL

- ESD-safe variable temperature, electronically controlled desoldering system (precise, closed loop electronic control)
- Totally **self-contained with internal pump**
- Operates pencil or pistol-grip style anti-static desoldering handle. Temperature variation: 500°F-850°F
- Designed for continuous production use
- **#4024P** consists of: power base, 5098AS pistol-style desoldering iron
- **#4024IL** consists of: power base, 5088AS pencil-style desoldering iron (shown)
- SPEC. COMPLIANCE: MIL-STD-2000, DOD-STD-2000-1B, WS-6536E, MIL-S-45743E
- 4000 series tiptets listed on page Weller 74
- UL listed

Cat. No.	UPC No.	Description	Power Unit			Shelf Pack Wt.		Shelf Pack
			V	W	Hz	lb	kg	
4024P	037103088550	Rework station-Output 24V	120	60	60	9.10	4.11	1
4024IL	037103088574	Rework station-Output 24V	120	60	60	9.10	4.11	1

The following is available only to authorized export distributors. Units not VDE or GS approved.

4024PD	037103091918	Rework station-Output 24V	230	115	50/60	9.10	4.11	1
4024ILD	037103091925	Rework station-Output 24V	230	115	50/60	9.10	4.11	1



Catalog No.: **4024P**  
**5098AS** pistol-style desoldering iron

For: **4024P**



Catalog No.: **5098AS**  
Pistol-style desoldering iron, 4006 tiptet

For: **4024IL**



Catalog No.: **5088AS**  
Pencil-style desoldering iron, 4006 tiptet

# 2024 series rework stations



- ESD-safe desoldering system **utilizes shop air**
- Operates with either pencil or pistol-grip style anti-static handle
- Temperature variation: 500°F - 850°F
- Used for electronic repair, rework or modification
- Rapid heat-up and vacuum response increases production
- **#2024P** consists of power base, 5098AS pistol-style desoldering iron (shown)
- **#2024IL** consists of power base, 5088AS pencil-style desoldering iron
- SPEC. COMPLIANCE: MIL-STD-2000, DOD-STD-2000-1B, WS-6536E, MIL-S-45743E
- UL listed
- 4000 series tiptets listed on page Weller 74



Cat. No.	UPC No.	Description	Power Unit			Shelf Pack Wt.		Shelf Pack
			V	W	Hz	lb	kg	
2024P	037103088567	Rework station-Output 24V	120	60	60	8.60	3.89	1
2024IL	037103088543	Rework station-Output 24V	120	60	60	8.60	3.89	1
<b>The following is available only to authorized export distributors. Units not VDE or GS approved.</b>								
2024PD	037103091932	Rework station-Output 24V	230	60	50/60	8.60	3.89	1
2024ILD	037103091949	Rework station-Output 24V	230	60	50/60	8.60	3.89	1



Catalog No.: **2024IL**  
**5088AS** pencil-style desoldering iron

**For: 2024P**



Catalog No.: **5098AS**  
Pistol-style desoldering iron, 4006 tiptet

**For: 2024IL**

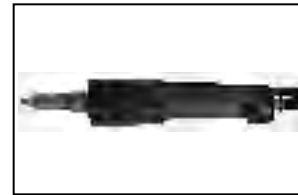

Catalog No.: **5088AS**  
Pencil-style desoldering iron, 4006 tiptet

# Temperature controlled rework stations accessories

Cat. No.	UPC No.	Description	Power Unit			Shelf Pack Wt.		Shelf Pack
			V	W	Hz	lb	kg	
HAP1	037103088314	Hot air pencil and stand	24	100	-	1.896	0.86	1
WHPS	037103088352	Preheat plate 24v, 50 watt	24	50	-	1.51	0.684	1
WSS1	037103102508	Weller Stand System w/o stands or holder	-	-	-	4.300	1.95	1
EC1201AP	037103088376	40w Soldering iron w/ETA tip and stand	24	40	-	0.37	0.16	1
EC1302AP	037103088383	20w iron w/EPH101 tip and stand	24	20	-	0.31	0.14	1
EC1503AP	037103088451	42w Soldering iron w/EMAtip and stand	24	42	-	0.31	0.14	1
DS1203AP	037103088291	Desoldering tool w/DSH112 tiptet and stand	24	54	-	0.31	0.14	1
5098AS	037103059758	Desolder pistol, high performance	24	60	-	1.061	.481	1
DS59	037103089205	High-performance desolder pistol	24	60	-	.581	.263	1
5088AS	037103088239	Inline desoldering iron, high performance	24	60	-	.487	.220	1
DS58	037103089212	High-performance desolder pencil	24	60	-	.581	.263	1
9911AS	037103035530	Micro-size iron w/9012 tip	24	40	-	0.37	0.16	1
9931AS	037103035646	Macro-size iron w/9960 tip	24	60	-	0.37	0.16	1
WST20	037103088475	Thermal stripper, no blades	-	-	-	.643	.291	1
58725726	037103088253	Blade styles for: AWG 12, 16, 24	-	-	-	0.63	0.28	1
58725729	037103088260	Blade styles for: AWG 12, 14, 16, 24	-	-	-	0.63	0.28	1
58725732	037103088277	Blade styles for: AWG 14, 18, 22, 26	-	-	-	0.63	0.28	1
58725718	037103088246	Flat cable stripper	-	-	-	0.063	0.028	1
58725723	037103088444	Cutting knives	-	-	-	0.063	0.028	1
4912	037103033925	Thermal wire strippers (large)	0-3	-	-	.800	.362	1
4913	037103033932	Resistance soldering tweezers	0-3	-	-	.493	.223	1
8800	037103030993	Deluxe iron holder	-	-	-	4.30	1.94	1
400	037103030368	Kleen-tip sponge and tray	-	-	-	0.93	0.42	1
2003	037103031150	Foot pedal	-	-	-	1.084	.491	1
4310	037103032591	Machine center motor	24	-	-	0.75	0.34	1
4911	037103033918	Accessory kit for 4310 machine center motor	-	-	-	.564	.255	1
FS1	037103088468	Foot pedal	-	-	-	.044	.020	1
ADP1	037103089526	Ungar tool adapter for WRS 3000 or WRS 1000	-	-	-	.120	.054	1
4914	037103033949	TRAC-AID kit (see below for list)	-	-	-	-	-	1
4375	037103032867	Optional accessory package (see below)	-	-	-	-	-	1

#4914 includes: 25 each Eyelets with shank sizes .050, .062, .088, .093, .118

#4375 includes: 4310, 4911, 4912, 4913, 4914, desoldering tiptet assortment

Continued on next page.



# Temperature controlled rework stations accessories - continued



Catalog No.: **HAP1**  
Hot air pencil and stand



Catalog No.: **WHPS**  
Preheat plate



Catalog No.: **WSS1**  
Stand system w/stands.  
Order iron holder and stands separately

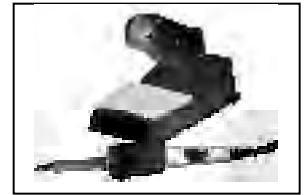

Catalog No.: **EC1201AP**  
40W Soldering iron and stand,  
ETA tip



Catalog No.: **EC1302AP**  
20W Soldering iron and stand,  
EPH101 tip



Catalog No.: **EC1503AP**  
42W Soldering iron and stand,  
EMAtip



Catalog No.: **DS1203AP**  
54W Desoldering tool and  
stand, DSH112 tiptlet



Catalog No.: **5098AS**  
Pistol-style desoldering iron,  
4006 tiptlet



Catalog No.: **DS59**  
Desoldering pistol and  
stand, 4006 tiptlet



Catalog No.: **5088AS**  
Pencil-style desoldering iron,  
4006 tiptlet



Catalog No.: **DS58**  
Desoldering pencil and  
stand, 4006 tiptlet



Catalog No.: **9911AS**  
Micro-size iron-24v,  
9012 tiptlet

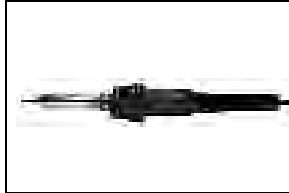

Catalog No.: **9931AS**  
Macro-size iron-24v,  
9960 tiptlet



Catalog No.: **WST20**  
Thermal stripper



Catalog No.: **4912**  
Thermal wire stripper (large)



Catalog No.: **4913**  
Resistance soldering  
tweezers



Catalog No.: **8800**  
Iron holder assembly



Catalog No.: **400**  
Sponge and tray



Catalog No.: **2003**  
Foot pedal



Catalog No.: **4310**  
Machine center motor for  
milling, drilling and grinding



Catalog No.: **4911**  
Accessory kit for 4310 motor



Catalog No.: **FS1**  
Foot pedal



Catalog No.: **ADP1**  
Adapter for 9911AS, 9911HC,  
9931AS, 5088AS, 5098AS

## Manual desoldering tools

### DS40 desoldering/repair tool



- Valuable repair tool for servicing printed circuit boards and solid state electronics
- Allows components to be removed and replaced quickly with less chance of heat damage
- Complete unit includes 40w tool, vacuum bulb, desoldering assembly with DST4 tiplet
- See page Weller 74 for tiplets
- UL listed

Cat. No.	UPC No.	Description	V	W	Hz	Shelf Pack Wt.		Shelf Pack
						lb	kg	
DS40	037103000941	Desoldering/repair tool	120	40	60	3.25	1.47	6
DSH40	037103473813	Head assembly w/DST-4 tiplet				0.25	0.11	1

## WDP series manual desoldering pumps



- Removes molten solder from printed circuit boards and electronic components
- Plunger seal spring creates extremely strong suction
- Tool features push button plunger release and lightweight aluminum body that withstands high temperatures
- Tips unscrew to allow easy removal of accumulated solder debris
- Standard and Teflon\* tips are available. (\* Teflon is a registered Trademark of DuPont)
- See page Weller 74 for tiplets

Cat. No.	UPC No.	Description	Shelf Pack Wt.		Shelf Pack
			lb	kg	
WDP07	037103480620	Desoldering pump w/0.07" tip	1.00	0.45	6
WDP07A	037103480637	Desoldering pump-Antistatic w/0.07" tip	1.00	0.45	6
WDP12	037103480590	Desoldering pump w/0.12" tip	1.00	0.45	6
WDP12A	037103480613	Desoldering pump-Antistatic w/0.12" tip	1.00	0.45	6
<b>Replacement parts</b>					
WDPSPK07	037103480712	Spare parts kit/0.7" tip	0.43	0.19	6
WDPSPK12	037103480705	Spare parts kit/.12" tip	0.43	0.19	6

## DSTCP Desoldering adapter



- Attaches to TC201 series irons
- Permits operator to desolder and resolder with same tool
- Wide range of desoldering tiplets available, see page Weller 74

Cat. No.	UPC No.	Description	Shelf Pack Wt.		Shelf Pack
			lb	kg	
DSTCP	037103472007	Desoldering adapter	0.25	0.11	1

## DS60 Desoldering adapter

- Versatile attachment for W60P series iron
- Permits operator to desolder and resolder with same tool
- Wide range of desoldering tiptets available, see page Weller 73



Cat. No.	UPC No.	Description	Shelf Pack Wt.		Shelf Pack
			lb	kg	
DS60	037103473974	Desoldering adapter	1.25	0.56	6



## Surface mount products Hot air rework systems WHA700

- Precise temperature control reduces amount of time boards and surrounding components are subjected to thermal stress
- Operates without expensive air pumps, allowing an inexpensive and simple way to rework and repair boards (requires compressed air or nitrogen)
- Adapters allow the use of other manufacturers' nozzles
- Precisely replaces chips as small as 5 mil pitch
- Built-in vacuum pick-up. No guessing when chip is ready for removal
- Complete range of nozzles available - see page Weller 67
- Hand tool 700/750W Anti-static, double insulated cable
- Power supply: 120V, 50/60Hz
- Air flow: a supply of air flow (or inert gas) from an external source is required 50 - 90psi. Continuously adjustable from 10 - 50 liters/min
- Air temp: 122°F - 1022°F ±86°F
- Vacuum: created by venturi tube from external air supply
- Standard equipment: power unit, hand piece, tool holder, and foot switch
- Accessories: 31 interchangeable nozzles



Cat. No.	UPC No.	Description	Shelf Pack Wt.		Shelf Pack
			lb	kg	
WHA700	037103129666	SMT Hot Air Rework Station	11.8	5.4	1

# WHA2000



- Self contained, ESD-safe hot air and SMD rework station
- Adjustable air flow and temperature
- Adapters allow the use of other manufacturers' nozzles
- Precisely replaces chips as small as 5 mil pitch
- Built-in vacuum pick-up. No guessing when chip is ready for removal
- Complete range of nozzles available - see page Weller 67
- Hand tool 700/750W Anti-static, double insulated cable
- Power supply: 120V, 50/60Hz
- Air flow: self-contained air source generates its own air flow. Continuously adjustable from 10 - 50 liters/min
- Air temp: 122°F - 1022°F ±86°F
- Vacuum: -0.6 bar (17.7" mercury) created by built-in reciprocating pump
- Standard equipment: power unit, hand piece, tool holder, and foot switch
- Accessories: 31 interchangeable nozzles

Cat. No.	UPC No.	Description	Shelf Pack Wt.		Shelf Pack
			lb	kg	
WHA2000	037103107241	Self Contained SMT Hot Air Rework Station	20.3	9.2	1

## Hot-Air-System-electronically controlled



- Ideal, compact design for reflow soldering, desoldering and rework in series production when using surface mounted components
- Consists of supply unit controlling infinitely variable hot gas flow and temperature
- Hot gas pencil with temperature resistant connection tube and pencil holder
- Electronically controlled temperature of low voltage pencil can be set from 122°F (50°C) to 1022°F (550°C)
- Unit requires compressed shop air/Inert gas (Nitrogen)
- Foot pedal activates non-static gas flow, enabling operator to solder/desolder even ESD sensitive components w/o risk of electro-static damage
- Temperature control with zero voltage crossing switch
- Infinitely variable gas flow

Cat. No.	UPC No.	Description	V	W	Hz	Shelf Pack Wt.		Shelf Pack
						lb	kg	
AG75	037103041593	Complete station	120	75	50/60	5.50	2.48	1

## Accessory products-electronic soldering stations WCM1 system calibration unit

- Designed to work with EC2002M series soldering stations
- Unit plugs in between station and soldering iron
- Allows user to calibrate tip temperature of soldering iron to outside temperature reference
- Enables timer setback mode (Allows station to set back to 350°F after period of inactivity)
- Insert fixed temperature into station and turning off front panel control knob
- Switching station display between °F and °C
- Resetting station electronics to original factory calibration
- Unit uses four "AA" alkaline batteries for power (included)
- 3 months normal life expectancy of batteries
- 16 button keypad
- Three digit LED display
- Connectors to attach to soldering station and iron



Cat. No.	UPC No.	Description	Shelf Pack Wt.		Shelf Pack
			lb	kg	
WCM1	037103089519	Calibration unit	0.50	0.23	1

## WC5000 system calibration unit

- Calibration unit for use with MC5000 and MC5001 microprocessor controlled soldering system
- Unit **MUST** be used in conjunction with calibration checks and procedures listed in tech sheet supplied with soldering unit



Cat. No.	UPC No.	Description	Shelf Pack Wt.		Shelf Pack
			lb	kg	
WC5000	037103591821	Calibration unit	0.25	0.11	1

## WC1000 and WC3000 system calibration units

- WC1000 calibration unit for use with EC1000/1001, EC2000/2001, DEC1001, EC1002 and EC2002 series electronic soldering systems
- WC3000 calibration unit for use with E3000/3001, EC4000/4001 series electronic soldering systems
- Units **MUST** be used in conjunction with calibration checks and procedures listed in tech sheet supplied with soldering unit



Cat. No.	UPC No.	Description	Shelf Pack Wt.		Shelf Pack
			lb	kg	
WC1000	037103480569	Calibration unit	0.25	0.11	1
WC3000	037103480576	Calibration unit	0.25	0.11	1

## WA2000 soldering iron analyzer

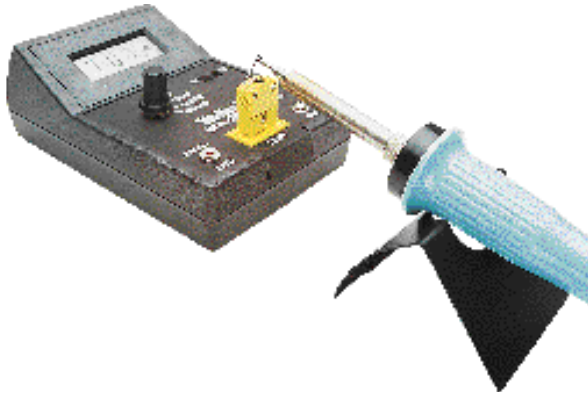

- Portable unit with battery life of 50 hours
- Checks either temperature stability using contact pyrometer or absolute temperature when measured with preconnected thermocouple assembly
- Use contact pyrometer for monitoring stability to Mil-STD-2000 specification
- Accurately measures iron resistance from tip to ground post on plug
- Tip to ground noise induced by iron: low level voltage measurable from working area of tip to ground

Cat. No.	UPC No.	Description	Shelf Pack Wt.		Shelf Pack
			lb	kg	
WA2000	037103592354	Soldering iron analyzer	0.50	0.22	1
<b>Replacement parts</b>					
CP01	037103592361	Contact pyrometer, large gauge	-	-	1
CP02	037103592378	Contact pyrometer, small gauge	-	-	1
K111	037103592380	Type K thermocouple assy., ETA tip	-	-	1
K121	037103592392	Type K thermocouple assy., EPH107 tip	-	-	1
K131	037103592750	Type K thermocouple assy., EMAtip	-	-	1
K141	037103592743	Type K thermocouple assy., WCC100 tip	-	-	1

## Accessory products - Iron stands PH2000



- Universal stand for holding soldering irons, desoldering irons, hot air irons

Cat. No.	UPC No.	Description	Shelf Pack Wt.		Shelf Pack
			lb	kg	
PH2000	037103102492	Iron stand assembly	0.75	0.33	1

## PH1201ESD

- Soldering tool stand with base, sponge and receptacle
- For EC1201P, EC1201PESD, EC1201A, TC201P, TC201PZ, TC201T, DS101P irons



Cat. No.	UPC No.	Description	Shelf Pack Wt.		Shelf Pack
			lb	kg	
PH1201ESD	037103591135	Iron stand assembly	0.75	0.33	1

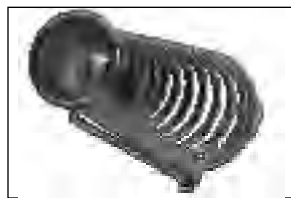

Catalog No.: **TC204**  
Spring and funnel assembly



Catalog No.: **TC205**  
Sponge

## PH1301ESD

- Soldering tool stand with base, sponge and receptacle
- For EC1301, EC1301ESD, EC1301R, EC1302, EC1302R, EC1302A, WM120 irons



Cat. No.	UPC No.	Description	Shelf Pack Wt.		Shelf Pack
			lb	kg	
PH1301ESD	037103591128	Iron stand assembly	0.75	0.33	1



Catalog No.: **IHF225EC**  
Spring and funnel assembly



Catalog No.: **TC205**  
Sponge

## PH1503



- Soldering tool stand with base, sponge and receptacle
- For EC1503, EC1503R, EC1503A irons

Cat. No.	UPC No.	Description	Shelf Pack Wt.		Shelf Pack
			lb	kg	
PH1503	037103043931	Iron stand assembly	0.75	0.33	1



Catalog No.: **EC254**  
Spring and funnel assembly



Catalog No.: **TC205**  
Sponge

## PH60



- Soldering tool stand with base, sponge and receptacle
- For W60P and "WP" series irons and irons with barrel diameter up to 15/32"/11.90 mm

Cat. No.	UPC No.	Description	Shelf Pack Wt.		Shelf Pack
			lb	kg	
PH60	037103474018	Iron stand assembly	11.50	5.20	6

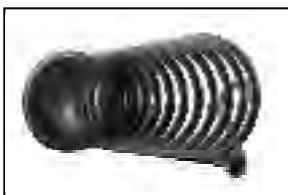

Catalog No.: **SFA60**  
Spring and funnel assembly



Catalog No.: **TC205**  
Sponge



- Soldering tool stand with base, sponge and receptacle
- For W100PG iron and irons with barrel diameter up to 19/32"/15.08 mm



Cat. No.	UPC No.	Description	Shelf Pack Wt.		Shelf Pack
			lb	kg	
PH100	037103474209	Iron stand assembly	11.50	5.20	6

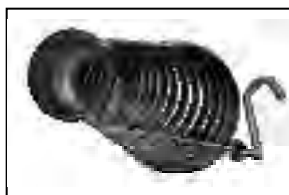

Catalog No.: **SFA100**  
Spring and funnel assembly



Catalog No.: **TC205**  
Sponge

**KH25P**

- Soldering tool stand with base, sponge and receptacle
- For MPR30 iron



Cat. No.	UPC No.	Description	Shelf Pack Wt.		Shelf Pack
			lb	kg	
KH25P	037103049179	Iron stand assembly	0.50	0.22	1

## PH1201FE

- Fume extraction soldering tool stand with base, sponge and receptacle
- For TC201FE, EC1201FE, EC1201AFE irons



Cat. No.	UPC No.	Description	Shelf Pack Wt.		Shelf Pack
			lb	kg	
PH1201FE	037103043948	Iron stand assembly	0.75	0.33	1



Catalog No.: **RSFFE**  
Spring and funnel assembly



Catalog No.: **TC205**  
Sponge

## PH1302FE



- Fume extraction soldering tool stand with base, sponge and receptacle
- Use when combining an EC1302A, EC1301, EC1301R, EC1302, EC1301ESD micro irons with an ECMFE fume extraction clip attachment

Cat. No.	UPC No.	Description	Shelf Pack Wt.		Shelf Pack
			lb	kg	
PH1302FE	037103043924	Iron stand assembly	0.75	0.33	1



Catalog No.: **RSFMFE**  
Spring and funnel assembly



Catalog No.: **TC205**  
Sponge

## TC204 spring and funnel assembly

- To attach to tool stand, wall or bench
- For EC1201A, EC1201P, EC1201PESD, TC201T, TC201P, TC201PZ, DS101P irons



Cat. No.	UPC No.	Description	Shelf Pack Wt.		Shelf Pack
			lb	kg	
TC204	037103475169	Spring and funnel assembly	0.25	0.11	1

## IHF225EC spring and funnel assembly

- To attach to tool stand, wall or bench
- For EC1302A, EC1302, EC1301, EC1301ESD, EC1302R, EC1301R, WM120, irons



Cat. No.	UPC No.	Description	Shelf Pack Wt.		Shelf Pack
			lb	kg	
IHF225EC	037103476920	Spring and funnel assembly	0.25	0.11	1

## EC254 spring and funnel assembly

- To attach to tool stand, wall or bench
- For EC1503A, EC1503, EC1503R irons



Cat. No.	UPC No.	Description	Shelf Pack Wt.		Shelf Pack
			lb	kg	
EC254	037103591999	Spring and funnel assembly	0.37	0.16	1

## RSFFE, RSFMFE spring and funnel assembly



- To attach to tool stand, wall or bench
- #AKFE1-1 fume extraction kit for TC201FE, EC1201AFE, EC1201FE (RSFFE) irons
- Also for irons fitted with Weller #ECMFE clip (RSFMFE) attachment

Cat. No.	UPC No.	Description	Shelf Pack Wt.		Shelf Pack
			lb	kg	
RSFFE	037103592316	Spring and funnel assembly	0.37	0.16	1
RSFMFE	037103004314	Spring and funnel assembly	0.37	0.16	1

## SFA60 spring and funnel assembly



- To attach to tool stand, wall or bench
- For PH60 tool stand. W60P, "WP" series irons and irons with barrel diameter up to 15/32"/11.90 mm

Cat. No.	UPC No.	Description	Shelf Pack Wt.		Shelf Pack
			lb	kg	
SFA60	037103474049	Spring and funnel assembly	2.75	1.24	6

## SFA100 spring and funnel assembly



- To attach to tool stand, wall or bench
- For PH100 tool stand. W100PG and irons with barrel diameter up to 19/32"/15.08 mm

Cat. No.	UPC No.	Description	Shelf Pack Wt.		Shelf Pack
			lb	kg	
SFA100	037103474216	Spring and funnel assembly	2.75	1.24	6

## TC205 and EC305 sponges

- One standard size fits all Weller soldering and desoldering tool stands



TC205



EC305

Cat. No.	UPC No.	Description	Shelf Pack Wt.		Shelf Pack
			lb	kg	
TC205	037103475176	Sponge for tool stand	0.37	0.16	10
EC305	037103104670	Sponge w/holes for tool stand	0.25	0.11	10

## DS2010

- Desoldering tool stand with base, sponge and holder
- For all Weller desoldering irons



Catalog No.: **TC205**  
Sponge

Cat. No.	UPC No.	Description	Shelf Pack Wt.		Shelf Pack
			lb	kg	
DS2010	037103480125	Desoldering iron stand assembly	0.75	0.33	1

## Accessory Products - Miscellaneous ECMFE, MSFE clip attachments



- Clip attachment to convert Weller EC1302 and EC1503 series soldering irons for use with Weller® Fumex® system
- Kit contains:
  - 1 ea - FUME ATTACHMENT ASSEMBLY
  - 1 ea - FE MINI FUNNEL
  - 5 ea - DS CLIPS
  - 1 ea - SPRING SHIELD
  - 7 ft - BLACK ESD TUBING
  - 1 ea - HOSE COUPLING
  - 1 ea - TUBE CLEANING BRUSH
- See iron fume extraction adapter kit table on page Weller 27

Cat. No.	UPC No.	Description	Shelf Pack Wt.		Shelf Pack
			lb	kg	
ECMFE	037103028167	Fumex clip attachment/irons	0.25	0.11	1
MSFE	037103043665	Fumex clip attachment/irons for Microsol, Microtouch irons	0.25	0.11	1

## AKFE series Fume Extraction Kits



- Fume extraction kit converts existing standard and micro irons for use with Weller® Fumex® system
- Variety of available models
- Complete with plastic tubing
- Detailed operating instructions included
- See iron fume extraction adapter kit table on page Weller 27

Cat. No.	UPC No.	Description	Shelf Pack Wt.		Shelf Pack
			lb	kg	
AKFE1	037103240713	Fume extraction kit - Hex, Pace, ESD	0.25	0.11	1
AKFE11	037103060600	Fume extraction kit - W100PG, WP25, WP40	0.25	0.11	1
AKFE2	037103044662	Fume extraction kit - Hakko 900 series	0.25	0.11	1
AKFE3	037103060631	Fume extraction kit - WP25-35, Jensen 47B723	0.25	0.11	1
AKFE4	037103060648	Fume extraction kit - SI325, 500, 2110, 5550	0.25	0.11	1
AKFE5	037103060617	Fume extraction kit - EDSYN 951, 930	0.25	0.11	1
AKFE6	037103060693	Fume extraction kit - 9910, 9941AS, UTC200	0.25	0.11	1

**ESF120, ESF120ESD (ESD safe)**

- Complete work center for placing, soldering and desoldering printed circuit boards
- Spring clamps hold workpiece in place
- Rotates through 360°, allowing work performance at any convenient angle
- Adjustable features allow handling of variety of circuit board sizes
- Socket key included
- Maximum surface: 6-1/4"/160 mm x 9-1/8"/235 mm
- ESF120ESD is ESD SAFE

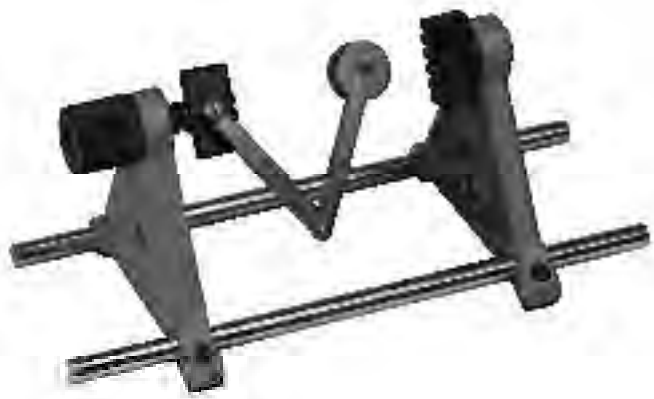

Cat. No.	UPC No.	Description	Shelf Pack Wt.		Shelf Pack
			lb	kg	
ESF120	037103592675	Vise for holding circuit boards	2.5	1.13	1
ESF120ESD	037103045041	Vise for holding circuit boards	2.5	1.13	1

**AC303P**

- Ideal for electronic kit building or electrical work
- Use bulb with any Weller® soldering iron
- Highly resistant material tip will not scratch delicate PC boards
- Carded



Cat. No.	UPC No.	Description	Shelf Pack Wt.		Shelf Pack
			lb	kg	
AC303P	037103475398	Desoldering bulb	1.25	0.56	1

## Lead free solder



AC1251



SW1251

- Alloy: 100% lead free, melts at 415°F
- Acid Core, Rosin Core and Solid Wire Solder can be ordered carded
- Acid Core and Solid Wire solder can be ordered bulk
- Important warnings in both English and Spanish on back of each package
- Helpful soldering directions on back of cards

Cat. No.	UPC No.	Description	Shelf Pack Wt.		Shelf Pack
			lb	kg	
<b>Acid core solder - Carded</b>					
AC0621	037103083128	0.062" Acid core solder, 1 oz.	0.5	0.23	6
AC0624	037103083111	0.062" Acid core solder, 4 oz.	2.5	1.13	6
AC1251	037103083081	0.125" Acid core solder, 1 oz.	0.5	0.23	6
AC1254	037103083074	0.125" Acid core solder, 4 oz.	2.5	1.13	6
<b>Acid core solder - Bulk pack</b>					
AC0621L	037103083098	0.062" Acid core solder, 1 lb.	10.5	4.76	10
AC0628	037103083104	0.062" Acid core solder, 8 oz.	5.5	2.49	10
AC1251L	037103083043	0.125" Acid core solder, 1 lb.	10.5	4.76	10
AC1258	037103083050	0.125" Acid core solder, 8 oz.	5.5	2.49	10
<b>Rosin core solder - Carded</b>					
RC0501	037103083036	0.05" Rosin core solder, 1 oz.	0.5	0.23	6
RC0504	037103083029	0.05" Rosin core solder, 4 oz.	2.5	1.13	6
RC0621	037103083012	0.062" Rosin core solder, 1 oz.	0.5	0.23	6
RC0624	037103083005	0.062" Rosin core solder, 4 oz.	2.5	1.13	6
<b>Solid wire solder - Carded</b>					
SW0621	037103082992	0.062" Solid wire solder, 1 oz.	0.5	0.23	6
SW0624	037103082985	0.062" Solid wire solder, 4 oz.	2.5	1.13	6
SW1251	037103082954	0.125" Solid wire solder, 1 oz.	0.5	0.23	6
SW1254	037103082947	0.125" Solid wire solder, 4 oz.	2.5	1.13	6
<b>Solid wire solder - Bulk pack</b>					
SW0621L	037103082961	0.062" Solid wire solder, 1 lb.	10.5	4.76	10
SW0628	037103082978	0.062" Solid wire solder, 8 oz.	5.5	2.49	10
SW1251L	037103082923	0.125" Solid wire solder, 1 lb.	10.5	4.76	10
SW1258	037103082930	0.125" Solid wire solder, 8 oz.	5.5	2.49	10



## Lead free solder kits

- Products in clean, clear, easy-to-read packaging
- Complete instructions on back of packaging
- Important warnings on back of packaging in both English and Spanish
- Kits for both Professional and Do it yourselfer



KFB



KPLUMB



KSILVER



KSPS



K3B

Cat. No.	UPC No.	Description	Shelf Pack Wt.		Shelf Pack
			lb	kg	
KFB	037103083173	0.35 oz. Flux in tube w/ brush, carded	0.70	0.32	6
KPLUMB	037103083142	4 oz. Solid wire plumber's solder, 2 oz. flux, brush, abrasive cloth, carded	3.00	1.36	6
KSILVER	037103083135	1 oz. Silver solder, 0.35 oz. flux in tube, carded	1.00	0.45	6
KSPS	037103085368	0.25 oz. Solder paste w/syringe applicator	0.50	0.23	6
K3B	037103083159	Three 4-1/2" Flux brushes, carded	0.70	0.32	6

## RC40

- 5 ft./1.52 m x .062 in./1.57 mm diameter
- 40/60 alloy
- Rosin core
- Ideal for electronics work
- Carded for point-of-purchase display
- Maximum surface 6-1/4 in./160 mm x 9-1/8 in./235 mm



Cat. No.	UPC No.	Description	Shelf Pack Wt.		Shelf Pack
			lb	kg	
RC40	037103473851	Rosin-core solder-carded	1.00	0.45	12
AC40	037103473769	Acid-core solder-carded	1.00	0.45	12

## RC60V

- 13 ft./3.96 m x .040 in./1.02 mm diameter
- Active rosin core - lead free
- Ideal for electronics work
- Carded dispenser tube with hang-up eye for point-of-purchase display



Cat. No.	UPC No.	Description	Shelf Pack Wt.		Shelf Pack
			lb	kg	
RC60V	037103013385	Rosin-core solder-carded	1.37	0.61	6

## Solder spools and bars - 1 lb.



- Complete line of 60/40 and 63/37 solder  
60/40 = 60% Tin/40% Lead  
63/37 = 63% Tin/37% Lead
- Approved for commercial and military applications
- Conforms to specifications QQ-S-571 type WRMAP-3
- Melting point: 60/40 = 375°F; 63/37 = 361°F
- Tensile strength: 60/40 and 63/37 = 6400 PSI
- Shear strength: 60/40 and 63/37 = 5700 PSI
- Hardness: 60/40 and 63/37 = 16.0 BHN
- Available in 1 lb. spools and 1 lb. bars

Cat. No.	UPC No.	Description	Shelf Pack Wt.		Shelf Pack
			lb	kg	
WS6016	037103592507	Solder, 60/40; .062" dia/16 ga/spool	5.00	2.26	5
WS6018	037103592491	Solder, 60/40; .050" dia/18 ga/spool	5.00	2.26	5
WS6021	037103592484	Solder, 60/40; .032" dia/21 ga/spool	5.00	2.26	5
WS6023	037103592477	Solder, 60/40; .025" dia/23 ga/spool	5.00	2.26	5
WS6316	037103592543	Solder, 63/37; .062" dia/16 ga/spool	5.00	2.26	5
WS6318	037103592446	Solder, 63/37; .050" dia/18 ga/spool	5.00	2.26	5
WS6321	037103592521	Solder, 63/37; .032" dia/21 ga/spool	5.00	2.26	5
WS6323	037103592514	Solder, 63/37; .025" dia/23 ga/spool	5.00	2.26	5
WSB60	037103592460	Solder, 60/40; bar	5.00	2.26	5
WSB63	037103592439	Solder, 63/37; bar	5.00	2.26	5

## WPB1 polishing bar



- Used for cleaning soldering tips
- Removes plastic resins, oxidation, silicone grease and other chemicals from tip
- After cleaning tip, always re-tin immediately to prevent oxidation

Cat. No.	UPC No.	Description	Shelf Pack Wt.		Shelf Pack
			lb	kg	
WPB1	037103590602	Polishing bar for soldering tips	0.25	0.11	1

# Tips for electronic soldering stations Weller "Longlife" tips

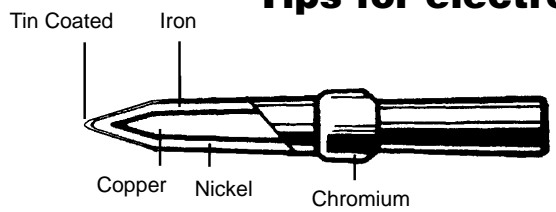

- A Weller "Longlife" tip is made of copper core which is electroplated with iron to extend the lifetime of the tip
- Tips are plated with iron, nickel and chromium, precision ground and provide maximum heat transfer from heater to tip
- The nickel and chromium protect the shank from corrosion and solder creep
- Tips are pre-tinned in the working area with solder. Keep tip tinned; wipe only before using
- Do not remove excess solder from heated tip before storing; the excess solder will prevent oxidation on the wettable surface when tip is reheated
- Use rosin or activated rosin fluxes. Acid type fluxes will greatly reduce tip life
- Tips in constant use should be removed and cleaned at least once a week
- If tip becomes unwettable, it may be cleaned hot with a Weller WPB1 polishing bar
- **IMPORTANT:** Use only Weller soldering tips. Use of non-Weller components may void product warranty if the non-Weller component causes damage to the unit

## ET series tips for EC1201A, EC1201AFE irons

- Solid copper, plated with iron, nickel and chromium, precision ground ET series tips
- Provide maximum heat transfer from the heater to the tip
- Individually packaged and packed 10 per box
- \* Available bulk packed (100 multiples only); 200 lot minimum order; greater discount offered on orders of 600 lots and above
- To order bulk, add suffix "B" to Cat. No. eg: ETA-B
- **IMPORTANT:** Use only Weller tips. Use of non-Weller components may void warranty if non-Weller component causes damage to the unit

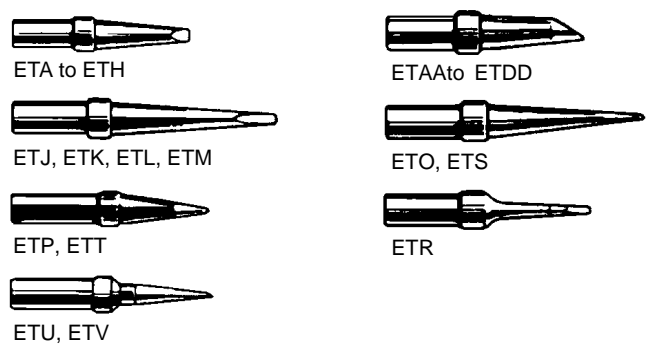

Cat. No.	UPC No.	Description	Tip Size		Reach		Shelf Pk. Wt.		Shelf Pack
			Inch	mm	Inch	mm	lb	kg	
ETA*	037103477286	Screwdriver tip	0.062	1.60	0.625	15.90	0.37	0.16	10
ETB*	037103477279	Screwdriver tip	0.093	2.40	0.625	15.90	0.37	0.16	10
ETC*	037103477262	Screwdriver tip	0.125	3.20	0.625	15.90	0.37	0.16	10
ETD*	037103477255	Screwdriver tip	0.187	0.48	0.625	15.90	0.37	0.16	10
ETH*	037103477231	Screwdriver tip	0.031	0.80	0.625	15.90	0.37	0.16	10
ETP*	037103477248	Conical tip	0.031	0.80	0.625	15.90	0.37	0.16	10
ETT	037103591548	Conical tip	0.024	0.60	0.625	15.90	0.37	0.16	10
ETU	037103591760	Single flat tip	0.015	0.40	0.700	17.80	0.37	0.16	10
ETV	037103591524	Single flat tip	0.024	0.60	0.700	17.80	0.37	0.16	10
ETAA	037103591579	Single flat tip	0.062	1.60	0.625	15.90	0.37	0.16	10
ETBB	037103591562	Single flat tip	0.093	2.40	0.625	15.90	0.37	0.16	10
ETCC	037103478085	Single flat tip	0.125	3.20	0.625	15.90	0.37	0.16	10
ETDD	037103478092	Single flat tip	0.187	4.80	0.625	15.90	0.37	0.16	10
ETO*	037103477224	Long conical tip	0.031	0.80	1.000	25.40	0.37	0.16	10
ETS*	037103478054	Long conical tip	0.015	0.40	1.000	25.40	0.37	0.16	10
ETJ	037103591555	Long screwdriver	0.031	0.08	1.000	25.40	0.37	0.16	10
ETK*	037103477217	Long screwdriver tip	0.046	1.20	1.000	25.40	0.37	0.16	10
ETL*	037103477200	Long screwdriver tip	0.078	2.00	1.000	25.40	0.37	0.16	10
ETM	037103478108	Long screwdriver tip	0.125	3.20	1.000	25.40	0.37	0.16	10
ETR	037103478115	Narrow screwdriver tip	0.062	1.60	0.625	15.90	0.37	0.16	10

# MT series tips for MT1500 series stations

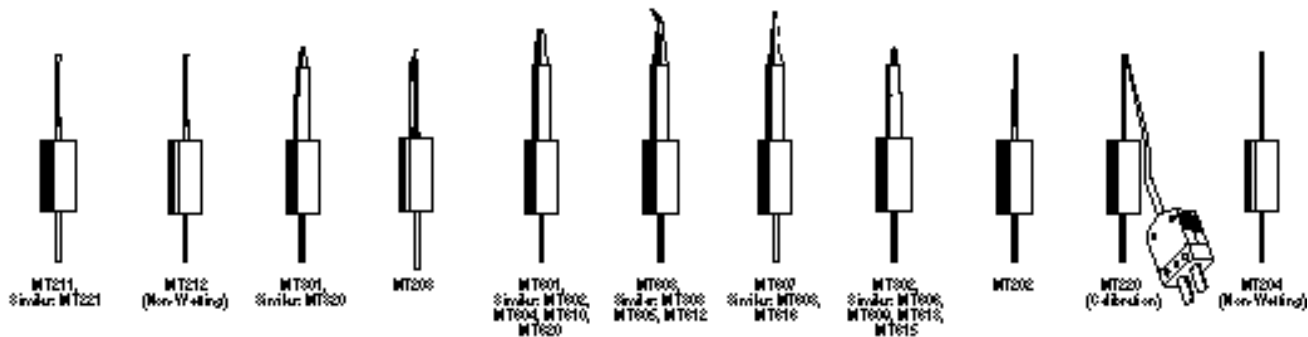

- Quick change plug-in tips are made from stainless steel
- Use only Weller soldering tips
- Heater and sensor located in tip

Cat. No.	UPC No.	Type	Tip Size		Reach		Comment	Shelf Pack
			Inch	mm	Inch	mm		
MT202	037103101495	Conical	0.030	0.76	1.00	25.4	-	1
MT203	037103101501	Conical	0.030	0.76	1.00	25.4	MIL-SPEC	1
MT204	037103101488	Conical	0.030	0.76	1.00	25.4	NON-WETTING	1
MT211	037103101457	Screwdriver	0.045	1.14	1.00	25.4	-	1
MT212	037103101365	Screwdriver	0.045	1.14	1.00	25.4	NON-WETTING	1
MT220	037103101099	Calibration Conical	0.030	0.76	-	-	-	1
MT221	037103101433	Micro	0.031	0.79	1.00	25.4	-	1
MT301	037103101907	Screwdriver	0.047	1.19	0.020	0.51	-	1
MT302	037103101914	Conical	0.015	0.38	0.020	0.51	-	1
MT303	037103101709	Bent Conical	0.015	0.38	0.32	8.13	-	1
MT320	037103108890	Calibration Screwdriver	0.047	1.19	0.20	5.08	-	1
MT601	037103097576	Screwdriver	0.070	1.78	0.385	9.78	-	1
MT602	037103097583	Screwdriver	0.100	2.54	0.39	9.78	-	1
MT603	037103097552	Conical, Bent	0.020	0.51	0.60	15.24	-	1
MT604	037103097569	Screwdriver	0.060	1.52	0.39	9.91	-	1
MT605	037103097538	Bent Conical	0.016	0.41	0.56	14.22	-	1
MT606	037103097545	Conical	0.016	0.41	0.53	13.46	-	1
MT607	037103097514	Bevel	0.020	0.51	0.53	13.5	-	1
MT608	037103097538	Bevel	0.040	1.02	0.56	14.22	-	1
MT609	037103097491	Conical	0.023	0.58	0.60	15.24	-	1
MT610	037103097507	Screwdriver	0.200	5.08	0.35	8.89	-	1
MT611	037103097477	Chisel	0.060	1.52	0.61	15.49	-	1
MT612	037103097484	Bent Conical	0.050	1.27	0.88	22.35	-	1
MT613	037103097453	Conical	0.020	0.51	0.52	13.21	-	1
MT614	037103097460	Chisel	0.100	2.54	0.19	4.38	-	1
MT615	037103097439	Conical	0.030	0.76	0.39	9.91	-	1
MT616	037103097446	Bevel	0.032	0.81	0.56	14.22	-	1
MT620	037103108968	Bevel, 30 Degree	0.063	1.59	0.385	9.78	-	1

Continued on next page.

# MT series tips for MT1500 series stations - SMD applications

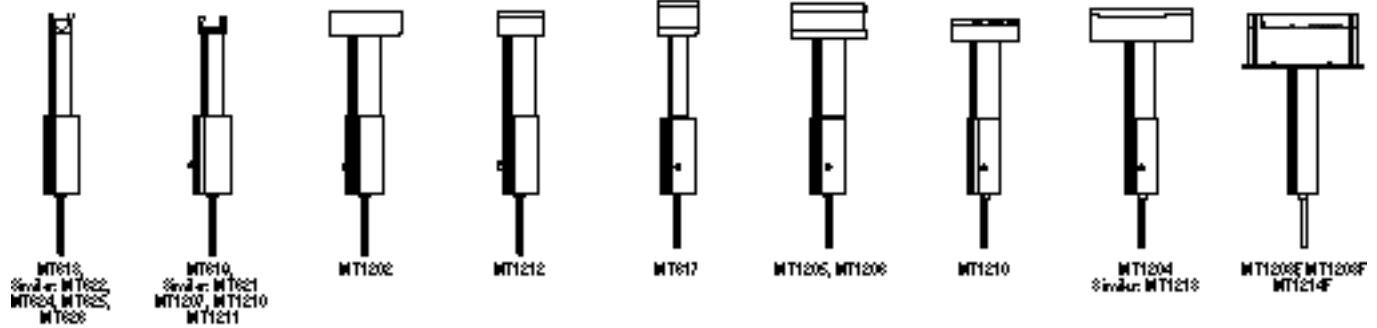

Cat. No.	UPC No.	Type	Length in./mm	Width in./mm	Height in./mm	Shelf Pack
MT617	037103108906	SMT Blade	0.410/10.414	0.022/0.559	0.280/7.112	1
MT618	037103109088	Chip 1206, 1210	0.070/1.778	0.195/9.429	0.070/1.778	1
MT619	037103109095	SOIC 14.16	0.410/10.414	0.200/5.08	0.090/2.286	1
MT621	037103108975	SOIC 8	0.180/4.572	0.200/5.08	0.090/2.286	1
MT622	037103108982	Chip 0805	0.060/1.524	0.090/2.286	0.070/1.778	1
MT623	037103108999	SOMC 16	0.450/11.49	0.270/6.858	0.090/2.286	1
MT624	037103109002	SOT23	0.100/2.540	0.068/1.727	0.055/1.397	1
MT625	037103109019	Chip 1808/1812	0.090/2.286	0.190/4.528	0.070/1.778	1
MT626	037103121905	Quad PLCC 18	0.105/2.667	0.303/7.696	0.150/3.81	1
MT627	037103122407	-	-	-	-	1
MT1201	037103109026	PLCC 28	0.500/12.700	0.500/12.700	0.150/3.81	1
MT1202	037103109033	PLCC 20	0.410/10.414	0.410/10.414	0.150/3.81	1
MT1203F	037103108913	Flex Leg PLCC 44	0.750/19.050	0.750/19.050	2.35/5.959	1
MT1204	037103109040	PLCC 32	0.500/12.70	0.500/12.70	0.150/3.81	1
MT1205	037103108920	SMT Blade	0.820/20.828	0.022/0.559	0.280/7.112	1
MT1206	037103109057	SMT Blade	0.620/16.748	0.022/0.559	0.280/7.112	1
MT1207	037103109064	SOIC 20	0.520/13.208	0.375/9.525	0.125/3.176	1
MT1208F	037103108937	Flex Leg PLCC 68	0.965/24.511	0.965/24.511	2.35/5.959	1
MT1209	037103109071	SOJ 28, SOM 36	0.740/18.796	0.365/9.017	0.125/3.175	1
MT1210	037103121899	SOIC 28	0.720/18.268	0.375/9.525	0.125/3.175	1
MT1211	037103121912	SOIC 24	0.620/15.748	0.375/9.525	0.125/3.175	1
MT1212	037103121875	PLCC 18	0.540/13.716	0.340/8.596	0.150/3.810	1
MT1213	037103121868	QFP 64-80	0.915/23.241	0.580/17.272	0.150/3.81	1
MT1214F	037103127754	Flex Leg PLCC 84	1.155/29.591	1.165/29.591	0.235/5.969	1

## EPH series tips for EC1302A iron

- Solid copper, plated with iron, nickel and chromium, precision ground EPH series tips
- Provide maximum heat transfer from heater to tip
- **IMPORTANT:** Use only Weller soldering tips. Use of non-Weller components may void product warranty if the non-Weller component causes damage to the unit

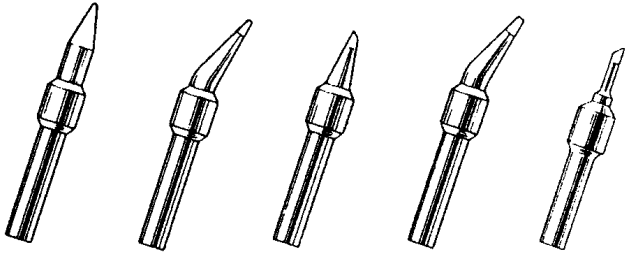

EPH101    EPH102    EPH103    EPH104    EPH105

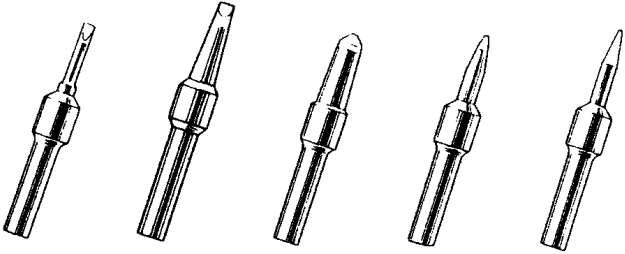

EPH106    EPH107    EPH108    EPH109    EPH110  
EPH111

Cat. No.	UPC No.	Description	Tip Size		Reach		Shelf Pk. Wt.		Shelf Pack
			Inch	mm	Inch	mm	lb	kg	
EPH101	037103479600	Micropoint tip	0.015	0.40	0.437	11.10	0.37	0.16	10
EPH102	037103479617	Bent conical tip	0.031	0.80	0.437	11.10	0.37	0.16	10
EPH104	037103479631	Bent conical tip	0.046	1.20	0.437	11.10	0.37	0.16	10
EPH103	037103479624	Single flat tip	0.031	0.80	0.312	7.90	0.37	0.16	10
EPH105	037103479648	Single flat tip	0.046	1.20	0.312	7.90	0.37	0.16	10
EPH106	037103479655	Screwdriver tip	0.062	1.60	0.437	11.10	0.37	0.16	10
EPH111	037103591531	Screwdriver tip	0.625	16.76	0.437	11.10	0.37	0.16	10
EPH107	037103479662	Chisel tip	0.078	2.00	0.437	11.10	0.37	0.16	10
EPH108	037103480231	Chisel tip	0.125	2.80	0.437	11.10	0.37	0.16	10
EPH109	037103479679	Conical tip	0.031	0.80	0.437	11.10	0.37	0.16	10
EPH110	037103474124	Conical tip	0.062	1.60	0.437	11.10	0.37	0.16	10
EPH112	037103593320	Long micropoint tip	0.015	0.40	0.625	15.90	0.37	0.16	10

## EM series tips for EC1503A

- Solid copper, plated with iron, nickel and chromium, precision ground EM series tips
  - Provide maximum heat transfer from heater to tip
  - Manufactured with patented\*\* taper fit to match heater sheath
  - Provides maximum heat transfer from heater to tip
  - **IMPORTANT:** Use only Weller soldering tips. Use of non-Weller components may void product warranty if the non-Weller component causes damage to the unit
- \*\* Patent No. 4560101

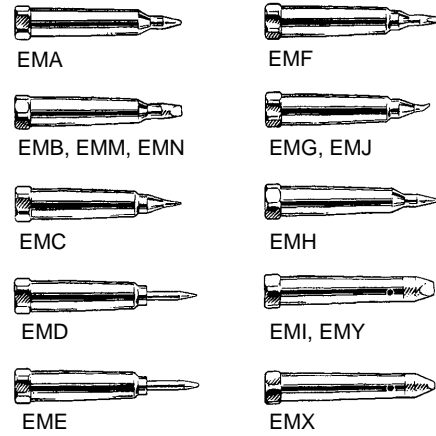

Cat. No.	UPC No.	Description	Tip Size		Reach		Shelf Pk. Wt.		Shelf Pack
			Inch	mm	Inch	mm	lb	kg	
EMA	037103591777	Chisel tip	0.062	1.60	0.42	10.66	0.37	0.16	10
EMB	037103591784	Chisel tip	0.093	2.40	0.42	10.66	0.37	0.16	10
EMF	037103592651	Chisel tip	0.046	1.20	0.52	13.20	0.37	0.16	10
EMH	037103591791	Chisel tip	0.031	0.80	0.42	10.66	0.37	0.16	10
EMI	037103000156	Chisel tip	0.203	5.23	0.42	10.66	0.37	0.16	10
EMM	037103104236	Chisel tip, long reach	0.125	3.30	0.31	7.87	0.37	0.16	10
EMN	037103104687	Chisel tip	0.125	3.30	0.31	7.87	0.37	0.16	10
EMC	037103592620	Conical tip	0.015	0.35	0.42	10.66	0.37	0.16	10
EMD	037103592637	Conical tip	0.015	0.35	0.61	15.49	0.37	0.16	10
EME	037103592644	Conical tip	0.031	0.81	0.65	16.51	0.37	0.16	10
EMG	037103592668	Bent conical tip	0.015	0.35	0.45	11.43	0.37	0.16	10
EMJ	037103592866	Bent conical tip	0.046	1.06	1.03	26.16	0.37	0.16	10
EMY	037103591814	Blunt chisel tip	0.125	3.30	0.42	10.66	0.37	0.16	10
EMX	037103591807	Blunt chisel tip	0.062	1.60	0.42	10.66	0.37	0.16	10

# PT series tips for TC201T iron

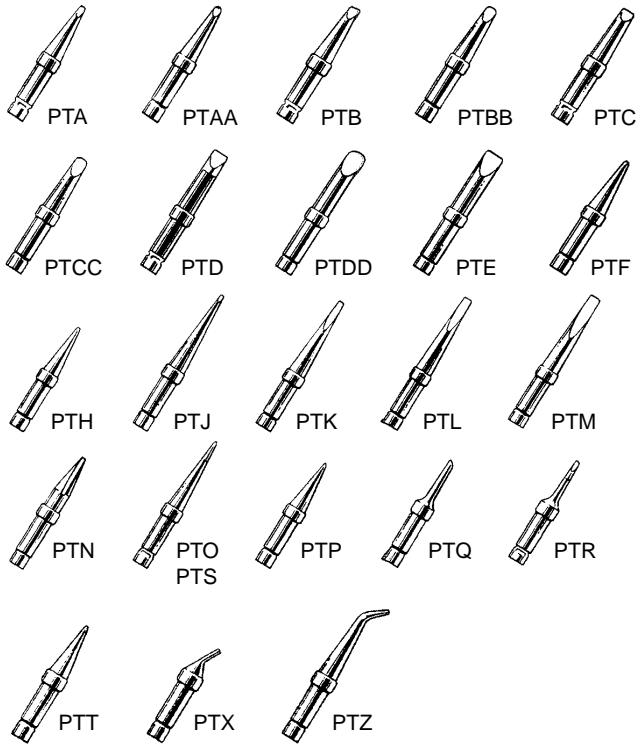

- Heavy iron plated, precision ground PT series tips
- Provide maximum heat transfer from heater to tip
- \* Available bulk packed (100 multiples only); 200 lot minimum order quantity; greater discount offered on orders of 600 lots and above
- To order bulk, add suffix "B" to Cat. No. eg: PTA7-B
- **IMPORTANT:** Use only Weller soldering tips. Use of non-Weller components may void product warranty if the non-Weller component causes damage to the unit
- Individually carded and packed 10 per box

600°F (315°C)		700°F (371°C)		800°F (427°C)		Description	Tip size		Reach		Shelf Pack Wt.		Shelf Pack
Cat. No.	UPC No. 037103	Cat. No.	UPC No. 037103	Cat. No.	UPC No. 037103		Inch	mm	Inch	mm	lb	kg	
PTA6	473011	PTA7*	473226	PTA8*	473417		Screwdriver	0.062	1.57	0.62	15.87	0.37	
PTAA6	473028	PTAA7*	473233	PTAA8*	473424	Single flat	0.062	1.57	0.62	15.87	0.37	0.16	10
PTB6	473035	PTB7*	473240	PTB8*	473431	Screwdriver	0.093	2.38	0.62	15.87	0.37	0.16	10
PTBB6	473042	PTBB7*	473257	PTBB8	473448	Single flat	0.093	2.38	0.62	15.87	0.37	0.16	10
PTC6	473059	PTC7*	473264	PTC8*	473455	Screwdriver	0.125	3.17	0.62	15.87	0.37	0.16	10
PTCC6	473066	PTCC7	473271	PTCC8	473462	Single flat	0.125	3.17	0.62	15.87	0.37	0.16	10
PTD6	473073	PTD7*	473288	PTD8*	473479	Screwdriver	0.187	4.74	0.62	15.87	0.37	0.16	10
PTDD6	473080	PTDD7	473295	PTDD8	473486	Single flat	0.187	4.74	0.62	15.87	0.37	0.16	10
PTE6	473097	PTE7*	473301	PTE8*	473493	Screwdriver	0.234	5.95	0.62	15.87	0.37	0.16	10
PTF6	473103	PTF7*	473338	PTF8*	473509	Conical flat	0.031	0.79	0.62	15.87	0.37	0.16	10
PTH6	473110	PTH7*	473325	PTH8*	473516	Screwdriver	0.031	0.79	0.62	15.87	0.37	0.16	10
PTJ6	591630	PTJ7	591623	PTJ8	591616	Screwdriver	0.015	0.39	1.00	25.40	0.37	0.16	10
PTK6	473127	PTK7*	473332	PTK8*	473523	Long screwdriver	0.046	1.19	1.00	25.40	0.37	0.16	10
PTL6	473134	PTL7*	473349	PTL8*	473530	Long screwdriver	0.078	1.98	1.00	25.40	0.37	0.16	10
PTM6	473141	PTM7*	473356	PTM8*	473547	Long screwdriver	0.125	3.17	1.00	25.40	0.37	0.16	10
PTN6	591753	PTN7	591746	PTN8	591739	Screwdriver	0.062	1.58	0.75	19.05	0.37	0.16	10
PTO6	473158	PTO7*	473363	PTO8*	473561	Long conical	0.031	0.79	1.00	25.40	0.37	0.16	10
PTP6	473165	PTP7*	473370	PTP8*	473554	Conical	0.031	0.79	0.62	15.87	0.37	0.16	10
PTQ6	591692	PTQ7	591685	PTQ8	591678	Single flat	0.031	0.79	0.62	15.87	0.37	0.16	10
PTR6	473172	PTR7*	473387	PTR8*	473585	Narrow screwdriver	0.062	1.58	0.62	15.87	0.37	0.16	10
PTS6	478023	PTS7*	478030	PTS8*	478047	Long conical	0.015	0.39	1.00	25.40	0.37	0.16	10
PTT6	591661	PTT7	591654	PTT8	591654	Conical	0.025	0.63	0.62	15.87	0.37	0.16	10
PTX6	591609	PTX7	591593	PTX8	591586	Bent, slotted	0.031	0.79	0.37	9.40	0.37	0.16	10
PTZ6	591722	PTZ7	591715	PTZ8	591708	Bent, slotted	0.020	0.50	1.00	25.40	0.37	0.16	10



## Tips for controlled output soldering irons CT series tips for W60P and W100PG irons

- Solid copper, plated with iron, nickel and chromium, precision ground CT series tips
- Provide maximum heat transfer from heater to tip
- Individually carded; tips for W60P iron packed 10 per box; tips for W100PG packed 6 per box
- \* Available bulk packed (100 multiples only); 200 lot minimum order quantity; greater discount offered on orders of 600 lots and above
- To order bulk, add suffix "B" to Cat. No. eg: CT6E7-B
- **IMPORTANT:** Use only Weller soldering tips. Use of non-Weller components may void product warranty if the non-Weller component causes damage to the unit

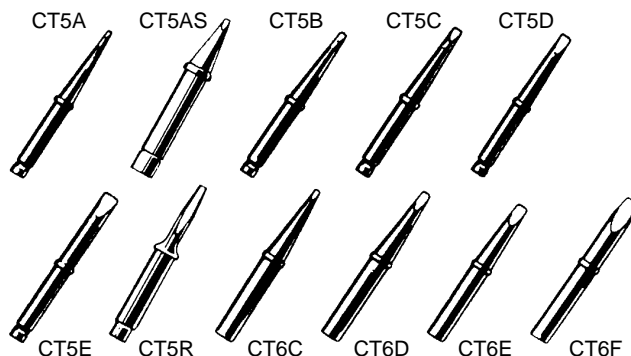

600°F (315°C)		700°F (371°C)		800°F (427°C)		Description	Tip size		Reach		Shelf Pack Wt.		Shelf Pack
Cat. No.	UPC No. <b>037103</b>	Cat. No.	UPC No. <b>037103</b>	Cat. No.	UPC No. <b>037103</b>		Inch	mm	Inch	mm	lb	kg	
CT5A6	472618	CT5A7	472625	CT5A8	472632		W60P Screwdriver tip	0.062	1.58	1.15	29.36	0.43	
CT5AS6	591487	CT5AS7	591470	CT5AS8	591463	W60P Screwdriver tip	0.062	1.58	0.62	15.87	0.37	0.16	10
CT5B6	472649	CT5B7	472656	CT5B8	472656	W60P Screwdriver tip	0.093	2.38	1.15	29.36	0.43	0.19	10
CT5C6	472670	CT5C7	472687	CT5C8	472694	W60P Screwdriver tip	0.125	3.17	1.15	29.36	0.43	0.19	10
CT5D6	472717	CT5D7	472724	CT5D8	472731	W60P Screwdriver tip	0.187	4.74	1.15	29.36	0.43	0.19	10
CT5E6	472748	CT5E7	472755	CT5E8	472762	W60P Screwdriver tip	0.250	6.35	1.15	29.36	0.43	0.19	10
CT5R6	591517	CT5R7	591517	CT5R8	591494	W60P Screwdriver tip	0.062	1.58	0.87	22.22	0.43	0.19	10
CT6C6	472847	CT6C7	472854	CT6C8	472861	W100PG Screwdriver tip	0.125	3.17	1.37	34.92	0.37	0.16	6
CT6D6	472878	CT6D7	472885	CT6D8	472892	W100PG Screwdriver tip	0.187	4.74	1.37	34.92	0.43	0.19	6
CT6E6	472908	CT6E7*	472915	CT6E8	472922	W100PG Screwdriver tip	0.250	6.35	1.37	34.92	0.50	0.22	6
CT6F6	472939	CT6F7*	472946	CT6F8	472953	W100PG Screwdriver tip	0.375	9.52	1.37	34.92	0.50	0.22	6

## Tips for professional soldering irons ST series tips for WP25, WP30, WP35 irons

- Solid copper, plated with iron, nickel and chromium, precision ground ST series tips
- Provide maximum heat transfer from heater to tip
- Individually carded and packed 10 per box
- Also available bulk packed (100 multiples only); add suffix "B" to Cat. No. eg ST1-B
- **IMPORTANT:** Use only Weller soldering tips. Use of non-Weller components may void product warranty if the non-Weller component causes damage to the unit

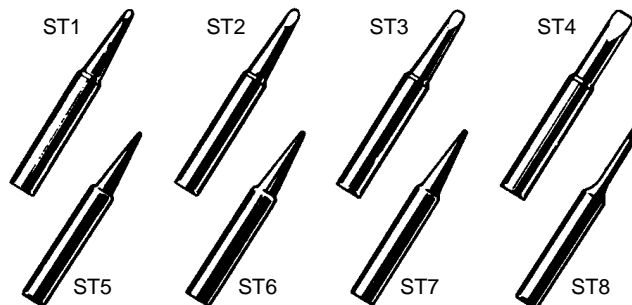

Cat. No.	UPC No.	Description	Tip Size		Reach		Shelf Pk. Wt.		Shelf Pack
			Inch	mm	Inch	mm	lb	kg	
ST1	037103472212	Screwdriver tip	0.062	1.58	0.75	19.05	0.25	0.11	10
ST2	037103472434	Screwdriver tip	0.093	2.38	0.75	19.05	0.25	0.11	10
ST3	037103472519	Screwdriver tip	0.125	3.17	0.75	19.05	0.25	0.11	10
ST4	037103472601	Screwdriver tip	0.187	4.74	0.75	19.05	0.25	0.11	10
ST5	037103472809	Single flat tip	0.031	0.79	0.75	19.05	0.25	0.11	10
ST6	037103473189	Screwdriver tip	0.031	0.79	0.75	19.05	0.25	0.11	10
ST7	037103473394	Conical tip	0.031	0.79	0.75	19.05	0.25	0.11	10
ST8	037103473578	Narrow SD tip	0.062	1.58	0.75	19.05	0.25	0.11	10

## WT series tips for ProPlus™ series irons

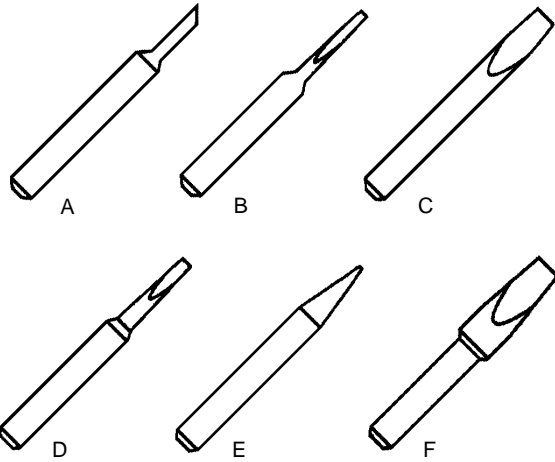

- Wide selection of tips in different sizes and styles
- Long-lasting iron plated - easy to replace
- **IMPORTANT:** Use only Weller soldering tips. Use of non-Weller components may void product warranty if the non-Weller component causes damage to the unit

### For WP40S, WP60S, WP60H soldering irons

Cat. No.	UPC No.	Description	Tip Size		Reach		Tip Style	Shelf Pk. Wt.		Shelf Pack
			Inch	mm	Inch	mm		lb	kg	
WT159	037103081193	30° Flat tip	.062	1.59	.062	1.59	A	0.27	0.12	10
WT313	037103081209	Screwdriver tip	.187	4.76	.187	4.76	C	0.31	0.14	10
WT324	037103081216	Screwdriver tip	.125	3.18	.125	3.18	B	0.20	0.09	10
WT358	037103081223	Screwdriver tip	.093	2.38	.375	9.53	D	0.20	0.09	10
WT397	037103081230	Screwdriver tip	.156	3.97	.750	19.05	C	0.30	0.14	10
WT399	037103081247	Screwdriver tip	.218	5.56	.375	9.53	C	0.30	0.14	10
WT417	037103081254	Screwdriver tip	.125	3.18	.750	19.05	C	0.30	0.14	10
WT451	037103081261	Screwdriver tip	.125	3.18	.500	12.70	B	0.20	0.09	10
WT463	037103081278	Screwdriver tip	.187	4.76	.562	14.29	B	0.28	0.13	10
WT513	037103081285	Conical tip	.125	3.18	.500	12.70	E	0.20	0.09	10
WT552	037103081292	Screwdriver tip	.187	4.76	.625	15.88	F	0.40	0.18	10
WT586	037103081308	Screwdriver tip	.125	3.18	.500	12.70	C	0.20	0.09	10
WT691	037103081315	Screwdriver tip	.062	1.59	.093	2.38	B	0.29	0.13	10
WT699	037103081322	Screwdriver tip	.062	1.59	.500	12.70	B	0.25	0.11	10
WT343	037103081339	Conical tip	.031	0.79	.625	15.88	E	0.20	0.09	10
WT773	037103081346	Screwdriver tip	.187	4.76	.625	15.88	F	0.40	0.18	10

### For WP100S soldering iron

Cat. No.	UPC No.	Description	Tip Size		Reach		Tip Style	Shelf Pk. Wt.		Shelf Pack
			Inch	mm	Inch	mm		lb	kg	
WT430	037103091369	Round flat tip	.375x45°	9.53x45°	-	-	A	1.00	0.45	10
WT470	037103091376	Wide screwdriver tip	.312	7.94	1.187	30.16	C	0.50	0.23	10
WT151	037103091345	Chisel tip	.375	9.53	1.00	25.4	C	1.00	0.45	10
WT108	037103091352	Conical tip	.062	1.59	.875	22.23	E	1.00	0.45	10
WT140	037103091338	Narrow screwdriver tip	.187	4.76	1.125	28.58	D	1.00	0.45	10

## MP series tips for WM120 iron

- Solid copper, plated with iron, nickel and chromium, precision ground MP series tips
- Provide maximum heat transfer from heater to tip
- Individually carded and packed 10 per box
- **IMPORTANT:** Use only Weller soldering tips. Use of non-Weller components may void product warranty if the non-Weller component causes damage to the unit

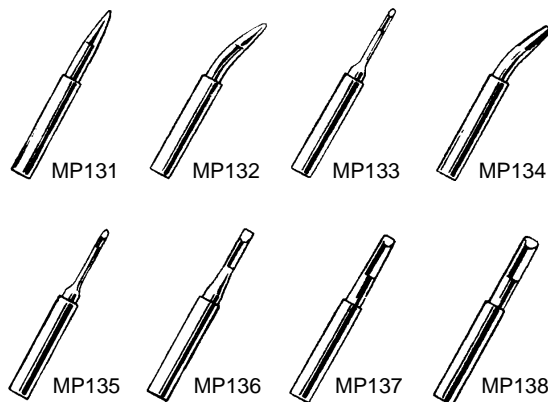

Cat. No.	UPC No.	Description	Tip Size		Reach		Shelf Pk. Wt.		Shelf Pack
			Inch	mm	Inch	mm	lb	kg	
MP131	037103474544	Conical tip	0.015	0.39	0.43	11.09	0.25	0.11	10
MP132	037103474575	Bent conical tip	0.031	0.79	0.43	11.09	0.25	0.11	10
MP133	037103474582	Single flat 40° tip	0.031	0.79	0.43	11.09	0.25	0.11	10
MP134	037103474599	Bent conical tip	0.046	1.19	0.43	11.09	0.25	0.11	10
MP135	037103474605	Single flat 40° tip	0.046	1.19	0.43	11.09	0.25	0.11	10
MP136	037103474612	Narrow screwdriver tip	0.062	1.58	0.43	11.09	0.25	0.11	10
MP137	03710347462	Screwdriver tip	0.078	1.98	0.43	11.09	0.25	0.11	10
MP138	037103474636	Chisel tip	0.109	2.77	0.43	11.09	0.25	0.11	10

## MPT series tips for MPR30 iron

- MPT series
- Micro-precision soldering tips for the most sophisticated of micro-soldering tasks
- **IMPORTANT:** Use only Weller soldering tips. Use of non-Weller components may void product warranty if the non-Weller component causes damage to the unit

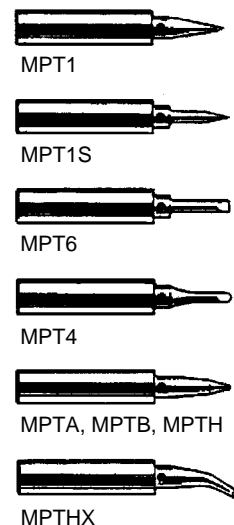

Cat. No.	UPC No.	Description	Tip Size		Reach		Shelf Pk. Wt.		Shelf Pack
			Inch	mm	Inch	mm	lb	kg	
MPT1	037103046024	Needle tip	0.013	0.25	0.75	19.05	0.25	0.11	10
MPT1S	037103045980	Needle tip	0.013	0.25	0.75	19.05	0.25	0.11	10
MPT6	037103045997	Chisel tip	0.062	1.60	0.75	19.05	0.25	0.11	10
MPT4	037103046031	Round tip	0.046	1.20	0.75	19.05	0.25	0.11	10
MPTB	037103046017	Flat tip	0.093	2.41	0.75	19.05	0.25	0.11	10
MPTA	037103045966	Flat tip	0.062	1.60	0.75	19.05	0.25	0.11	10
MPTH	037103046000	Flat tip	0.031	0.80	0.75	19.05	0.25	0.11	10
MPTHX	037103045973	Flat tip bent	0.031	0.80	0.75	19.05	0.25	0.11	10

# Tips for surface mount products

## SMT series tips and adapters

### Configurations

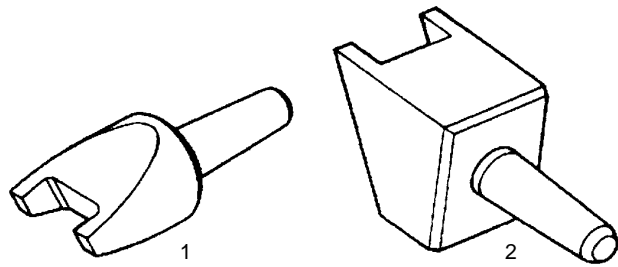

### Styles

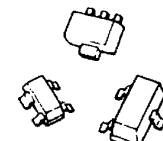
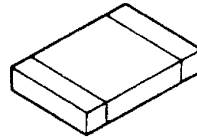
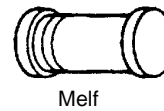
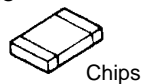

Small Outline Transfer (S.O.T.)

### Adapters

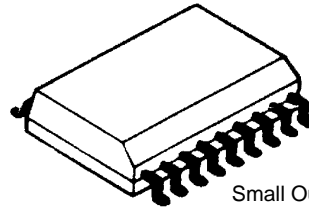
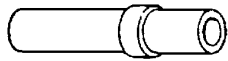

Small Outline I.C. (S.O.I.C.)

- Helpful, effective soldering tips make quick work of repairing surface mount assemblies using chip resistor/capacitors, and small outline devices
- Unique adapter system allows tip use in SMT applications with current Weller stations

Cat. No.	UPC No.	Configuration Style	Design	Component Size (Nominal)				Shelf Pack
				L	x W	x H		
SMT0504A	037103590909	1	Chips	0405	.040	x .050	x .040	1
		1	Chips	0504	.050	x .040	x .040	1
		1	Chips	0505	.050	x .050	x .040	1
SMT0805B	037103590916	1	Chips	0705	.070	x .050	x .040	1
		1	Chips	0805	.080	x .050	x .050	1
SMT1005C	037103590985	1	Chips	1005	.100	x .050	x .050	1
SMT1206D	037103590923	1	Chips	1206	.120	x .060	x .060	1
		1	Chips	1210	.120	x .100	x .065	1
SMT1505E	037103590992	1	Chips	1505	.150	x .050	x .065	1
SMT1808F	037103590930	1	Chips	1805	.180	x .050	x .065	1
		1	Chips	1808	.180	x .080	x .065	1
		1	Chips	1812	.180	x .120	x .065	1
SMT1825G	037103591005	1	Chips	1825	.180	x .250	x .065	1
SMT80H	037103590947	1	MELF	SOD80	.138	x .063	Dia.	1
		1	MELF	SOD87	.138	x .081	Dia.	1
SMT23I	037103590954	1	S.O.T.	SOT23	.118	x .098	x .043	1
		1	S.O.T.	SOT143	.118	x .098	x .043	1
SMT89J	037103591012	1	S.O.T.	SOT89	.181	x .167	x .063	1
SMT8K	037103591029	2	S.O.I.C.	SO8	.197	x .157	x .066	1
SMT14L	037103591036	2	S.O.I.C.	SO14	.344	x .157	x .066	1
SMT16L	037103095503	2	S.O.I.C.	SO16	-	-	-	1
SMTA	037103590978	Tip adapter for EC1201 series iron						1
SMTA6	037103591043	600°F tip adapter for TC201 series iron						1
SMTA7	037103590961	700°F tip adapter for TC201 series iron						1
SMTA8	037103591050	800°F tip adapter for TC201 series iron						1
SMTAEM	037103592774	Tip adapter for EC1503 series iron						1

# Hot air nozzles for WHA700 & WHA 2000

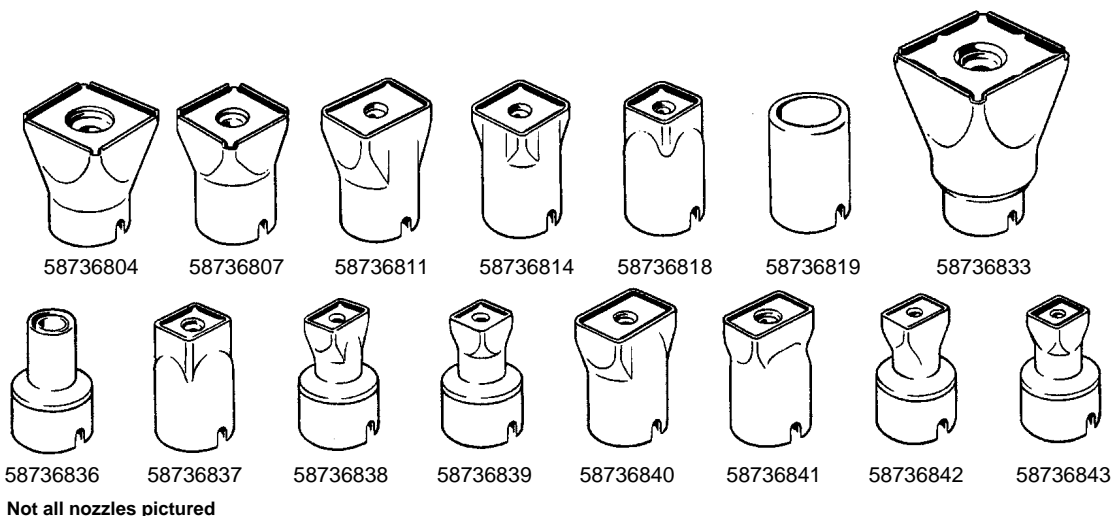

Cat. No.	UPC No.	Description	Fig. No.	Size	Size	Shelf Pack
				mm	in.	
58736818	037103045058	Hot air nozzle		14.1 x 14.1	0.555 x 0.555	1
58736814	037103045027	Hot air nozzle		17.7 x 17.7	0.697 x 0.697	1
58736811	037103045034	Hot air nozzle		17 x 23	0.906 x 0.906	1
58736807	037103045003	Hot air nozzle		20.4 x 20.4	0.803 x 0.803	1
58736839	037103060884	Hot air nozzle		11 x 11	0.433 x 0.433	1
58736838	037103060914	Hot air nozzle		14.5 x 10	0.571 x 0.394	1
58736837	037103060907	Hot air nozzle		15.5 x 13	0.610 x 0.512	1
58736804	037103045010	Hot air nozzle		25.3 x 25.3	0.997 x 0.997	1
58736843	037103062673	Hot air nozzle		10 x 8	0.394 x 0.315	1
58736842	037103060877	Hot air nozzle		14 x 10	0.551 x 0.394	1
58736841	037103060860	Hot air nozzle		19 x 12	0.748 x 0.472	1
58736840	037103060891	Hot air nozzle		21.5 x 14	0.846 x 0.551	1
58736819	037103045065	Nozzle adapter		21 dia.	0.825 Dia.	1
58736833	037103060853	Hot air nozzle		32 x 32	1.26 x 1.26	1
58736836	037103060822	Hot air nozzle		11.5 dia.	0.453 Dia.	1
58736857	037103089359	Hot air nozzle		38.0 x 38.0	1.497 x 1.497	1
58736858	037103105455	Hot air nozzle	SK0417	44.0 x 32.0	1.732 x 1.260	1
58736867	037103105479	Hot air nozzle	NR050	4.0 Dia.	0.157 Dia.	1
58736870	037103105486	Hot air nozzle	NR10	7.0 Dia.	0.276 Dia.	1
58736873	037103105462	Hot air nozzle	SK0490	40.0 x 40.0	1.575 x 1.575	1
58736875	037103105431	Hot air nozzle	NA20	-	-	1
△ 58736876	037103132635	Hot air nozzle	SK509/A	27.0 x 12.0	1.064 x .473	1
△ 58736877	037103132611	Hot air nozzle	SK509/B	29.0 x 17.0	1.143 x .670	1
△ 58736880	037103132604	Hot air nozzle	SK460/A	24.0 x 12.0	.946 x .473	1
58736881	037103104267	Hot air nozzle	SINGLE	2.5 Dia.	0.098 Dia.	1
58736882	037103104274	Hot air nozzle	40 DEG BENT	3.0 x 1.5	0.118 x 0.059	1
58736883	037103104281	Hot air nozzle	DUAL SINGLE	2.5	0.098	1
△ 58736890	037103132598	Hot air nozzle	SK568	43.0 x 43.0	1.694 x 1.694	1
△ 58736891	037103132581	Hot air nozzle	SK572	36.0 x 36.0	1.418 x 1.418	1
△ 58736892	037103132574	Hot air nozzle	SK0578	27.0 x 14.0	1.064 x .552	1
<b>Replacement parts</b>						
W58713798	037103590268	CSF rubber insert - 10 per bag - small 3mm				1 bag
W58713799	037103590275	CSF rubber insert - 10 per bag - large 6mm				1 bag

△ Made to order, contact customer service for delivery.

## Hot air nozzles for WRS systems (for HAP1 hot air pencil)

Cat. No.	UPC No.	Description	Fig. No.	Size		Shelf Pack
				mm	in.	
58727059	037103592811	Hot air nozzle	-	1.2 Dia.	0.047 Dia.	1
58727060	037103592804	Hot air nozzle	-	3.0 Dia.	0.118 Dia.	1
58727116	037103105301	Hot air nozzle	R02	0.8 Dia.	0.032 Dia.	1
58727772	037103105257	Hot air nozzle	F06	12.0x1.5	0.472x0.059	1
58727773	037103105264	Hot air nozzle	F04	10.0x1.5	0.394x0.059	1
58727774	037103105271	Hot air nozzle	F02	8.0x1.5	0.315x0.059	1
58727775	037103105318	Hot air nozzle	FD4	10.0x1.5	0.394x0.059	1
58727776	037103105325	Hot air nozzle	FD2	8.0x1.5	0.315x0.059	1
58727777	037103105776	Hot air nozzle	Q02	6.0x6.5	0.236x0.256	1
58727778	037103105370	Hot air nozzle	Q04	6.0x9.0	0.236x0.354	1
58727779	037103105424	Hot air nozzle	D04	10.5x10.5	0.413x0.413	1
58727780	037103105363	Hot air nozzle	Q06	15.0x10.0	0.591x0.394	1
58727781	037103105400	Hot air nozzle	D08	15.0x10.0	0.591x0.394	1
58727782	037103105417	Hot air nozzle	D06	13.0x10.0	0.512x0.394	1
58727783	037103105356	Hot air nozzle	Q08	15.0x12.5	0.591x0.492	1
58727784	037103105394	Hot air nozzle	D10	18.0x10.0	0.709x0.394	1
58727785	037103105349	Hot air nozzle	Q10	18.0x18.0	0.709x0.709	1
58727786	037103105769	Hot air nozzle	R08	2.0 Dia	0.079 Dia.	1
58727787	037103105288	Hot air nozzle	R10	2.0 Dia.	0.079 Dia.	1
58727808	037103105332	Hot air nozzle	R01	-	-	1

## MT and MTG series tips for Marksman® irons

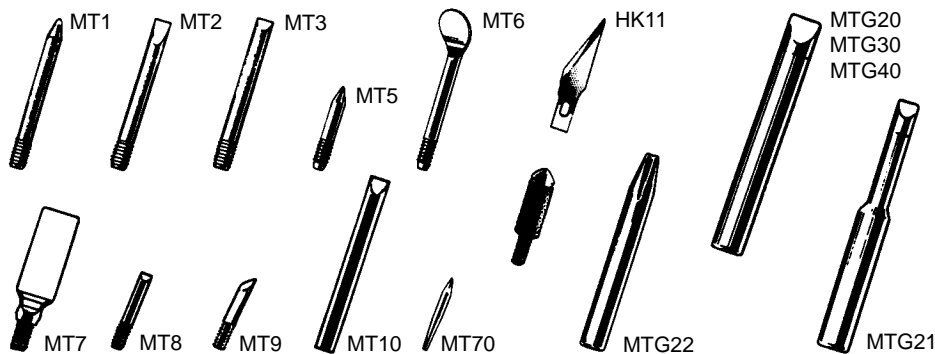

- Marksman® replacement tips
- Nickel-plated copper tips are available in a variety of styles
- MTG series tips are iron-plated for heavy-duty soldering irons
- Carded for point-of-purchase display
- Packed 6 and 10 cards per carton

Cat No.	UPC No.	Description	Tip Size		Packed	Shelf Pack
			Inch	mm		
MT1	037103472175	SP23/SP25D Cone shaped tip	1/8	3	2/card	6Cds
MT2	037103472410	SP23/SP25D Screwdriver tip	1/8	3	2/card	6Cds
MT3	037103472502	SP23/SP25D Chisel tip	1/8	3	2/card	6Cds
MT5	037103472793	SP23/SP25D Woodburning tip	1/8	3	1/card	6Cds
MT6	037103473004	SP23/SP25D Smoother tip	1/8	3	1/card	6Cds
MT7	037103477835	SP23/SP25D Macrame tip	-	-	1/card	6Cds
MT8	037103478061	SP23WB Woodburning tip	1/8	3	1/card	10Cds
MT9	037103478078	SP23WB Woodburning tip	1/8	3	1/card	10Cds
MT10	037103473615	SP40/SP40D Chisel tip	1/4	6	2/card	6Cds
MT70	037103479808	SP12 Cone shape tip	1/8	3	2/card	10Cds
MTG20	037103476593	SPG80/WLC200 Chisel tip	3/8	10	1/card	6Cds
MTG21	037103476609	SPG80/WLC200 Chisel tip	1/4	6	1/card	6Cds
MTG22	037103479822	SPG80/WLC200 Cone shape tip	3/8	10	1/card	6Cds
MTG30	037103477903	SP120/SP120D Chisel tip	1/2	13	1/card	6Cds
MTG40	037103478672	SP175 Chisel tip	5/8	16	1/card	6Cds
HK11	037103473622	SP23/SP25D Blade and Chuck	1/8	3	1/card	6Cds

## Tips for cordless soldering tools

### WPT and WHC series tips for WSTA3 and WPA2 Pyropen® irons

- 13 soldering tip combinations available
- Multi-purpose catalyst and hot blow tip
- 3 inactive hot air nozzles for low temp heat
- **IMPORTANT:** Use only Weller soldering tips. Use of non-Weller components may void product warranty if the non-Weller component causes damage to the unit

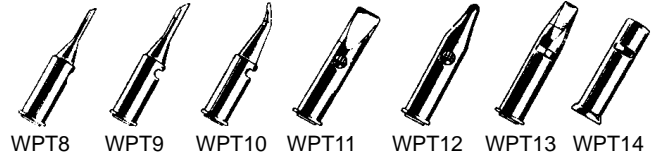
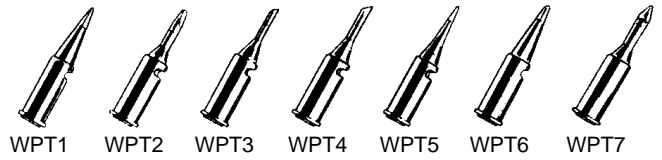

Cat. No.	UPC No.	Description	Tip Size		Shelf Pk. Wt.		Shelf Pack
			Inch	mm	lb	kg	
WPT1	037103472403	Taper needle tip	-	-	0.10	.05	1
WPT2	037103472427	2mm Chisel tip	.078	2	0.10	.05	1
WPT3	037103472441	2mm Spade tip	.078	2	0.10	.05	1
WPT4	037103472458	3mm 45° Spade tip	.118	3	0.10	.05	1
WPT5	037103472489	Taper needle tip	-	-	0.10	.05	1
WPT6	037103472496	2mm Micro Spade tip	.078	2	0.10	.05	1
WPT7	037103472526	0.5mm Sq. taper pyramid tip	.020	0.5	0.10	.05	1
WPT8	037103472533	2mm 35° Spade tip	.078	2	0.10	.05	1
WPT9	037103472540	3mm 35° Spade tip	.118	3	0.10	.05	1
WPT10	037103472557	1mm Offset taper needle tip	.040	1	0.10	.05	1
WPT11	037103472595	8mm High powered chisel tip	.315	8	0.10	.05	1
WPT12	037103472700	3mm High powered round head needle tip	.118	3	0.10	.05	1
WPT13	037103472786	5mm High powered long taper chisel tip	.197	5	0.10	.05	1
WPT14	037103472816	8.4mm Multi-purpose catalyst	.330	8.4	0.10	.05	1
WHC50	037103472823	2.5mm I.D. Hot blow tip	.098	2.5	0.10	.05	1
WHC51	037103472991	3.3mm I.D. Hot air tip	.130	3.3	0.10	.05	1
WHC52	037103473400	4.9mm I.D. Hot air tip	.193	4.9	0.10	.05	1
WHC53	037103473592	7.4mm I.D. Hot air tip	.291	7.4	0.10	.05	1

## WPT and WHC series tips for WST2 Pyropen® Jr iron

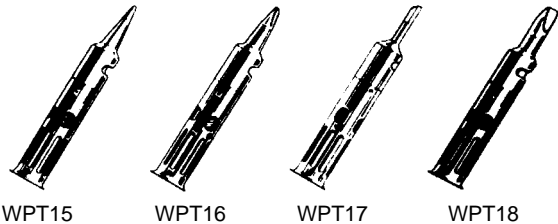

WPT15

WPT16

WPT17

WPT18



WHC54



WHC55

- “Longlife” tips last 10 times longer than conventional tips
- 4 soldering tip combinations available
- 2 inactive hot air nozzles for low temp heat
- IMPORTANT: Use only Weller soldering tips. Use of non-Weller components may void product warranty if the non-Weller component causes damage to the unit

Cat. No.	UPC No.	Description	Pk. Wt.		Shelf Pack
			lb	kg	
WPT15	037103477521	0.5mm tapered needle tip	0.10	0.05	1
WPT16	037103477538	3.0mm Chisel point tip	0.10	0.05	1
WPT17	037103477545	3mm Spade point tip	0.10	0.05	1
WPT18	037103590831	Stained glass tip	0.10	0.05	1
WHC54	037103477552	1.5mm Hot air tip	0.10	0.05	1
WHC55	037103477569	4.9mm Hot air tip	0.10	0.05	1

## PS series tips for Portasol® irons

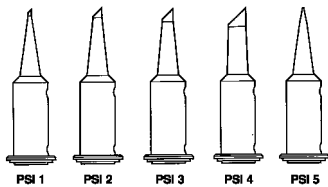

PSI 1

PSI 2

PSI 3

PSI 4

PSI 5

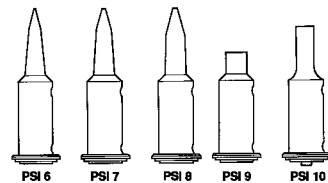

PSI 6

PSI 7

PSI 8

PSI 9

PSI 10

- Portasol® replacement tips for PSI100 tool
- Eight different size soldering tips to chose from
- One hot blower tip
- One hot knife tip
- Tips cannot be used with other Portasol® irons

Portasol® is a registered trademark of Oglesby and Butler Limited

Cat. No.	UPC No.	Packed	Description	Pack Wt.		Shelf Pack
				lb	kg	
PSI 1	037103062666	Carded	1/32" (1.0mm) single flat Soldering Tip - temperature range up to 850°F (450°C)	0.20	0.09	5
PSI 2	037103062659	Carded	3/32" (2.4mm) single flat Soldering Tip - temperature range up to 850°F (450°C)	0.20	0.09	5
PSI 3	037103062628	Carded	1/8" (3.2mm) single flat Soldering Tip - temperature range up to 850°F (450°C)	0.20	0.09	5
PSI 4	037103062635	Carded	3/16" (4.8mm) single flat Soldering Tip - temperature range up to 850°F (450°C)	0.20	0.09	5
PSI 5	037103062604	Carded	1/32" (1.0mm) single flat Soldering Tip - temperature range up to 850°F (450°C)	0.20	0.09	5
PSI 6	037103062611	Carded	3/32" (2.4mm) double flat Soldering Tip - temperature range up to 850°F (450°C)	0.20	0.09	5
PSI 7	037103062581	Carded	1/8" (3.2mm) double flat Soldering Tip - temperature range up to 850°F (450°C)	0.20	0.09	5
PSI 8	037103062598	Carded	3/16" (4.8mm) double flat Soldering Tip - temperature range up to 850°F (450°C)	0.20	0.09	5
PSI 9	037103060983	Carded	Hot Blower Tip -temperature range up to 850°F (450°C)	0.20	0.09	5
PSI 10	037103060990	Carded	Hot Knife Tip -temperature range up to 850°F (450°C)	0.20	0.09	5



## T series tips for P1 Portasol® irons

- Portasol® replacement tips for P1 tool
- Soldering tips and heat tool accessories convert iron into 4 different tools: Soldering iron, Blow torch, Hot blower and Hot knife
- T1 to T4 tips temperature range up to 850°F (450°C)
- T5 blow torch temperature range up to 2372°F (1300°C)
- T6, hot blower and T7 hot knife temperature range up to 850°F (450°C)
- Portasol® is a registered trademark of Oglesby and Butler Limited

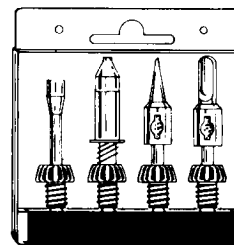
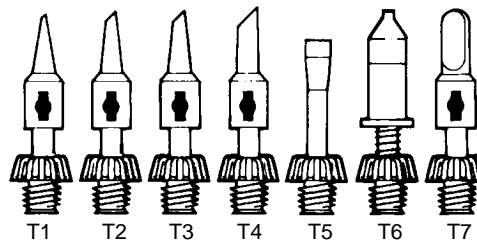

TB10 (T5, T6, T1, T7)

Cat. No.	UPC No.	Description	Tip Size		Reach		Shelf Pk. Wt.		Shelf Pack
			Inch	mm	Inch	mm	lb	kg	
T1	037103593411	Fine point soldering tip	0.031	0.79	0.75	19.05	0.25	0.11	5
T2	037103593429	Spade tip	0.093	2.38	0.75	19.05	0.25	0.11	5
T3	037103593429	Spade tip	0.125	3.17	0.75	19.05	0.25	0.11	5
T4	037103593443	Spade tip	0.187	4.74	0.75	19.05	0.25	0.11	5
T5	037103593450	Blow torch tip-temp range up to 2372°F	-	-	-	-	0.25	0.11	5
T6	037103593467	Hot blower tip-temp range up to 850°F	-	-	-	-	0.25	0.11	5
T7	037103593399	Hot knife tip-temp range up to 850°F	-	-	-	-	0.25	0.11	5
TB10	037103593405	Tip kit; T1, T5, T6, T7 in durable case	-	-	-	-	5.00	2.26	5

## C1C Portasol® tips and accessories

- Portasol® replacement tips for C1C tool
- Interchangeable screw-in tip
- Catalytic converter provides powerful and safe flameless combustion
- Tips cannot be used with other Portasol® irons
- Chisel, fine and hot knife tips are available

Portasol® is a registered trademark of Oglesby and Butler Limited

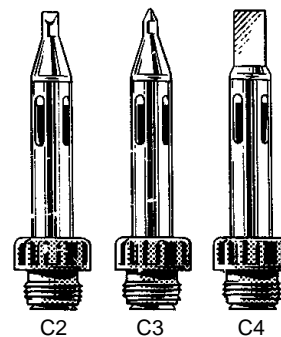

Cat No.	UPC No.	Description	Tip Size		Pack Wt.		Shelf Pack
			Inch	mm	lb	kg	
C2	037103001719	Chisel tip	.12	3.17	.25	.11	5
C3	037103001726	Fine tip	.12	3.17	.25	.11	5
C4	037103001702	Hot knife tip	—	—	.25	.11	5

# Tiplets for desoldering tools

## Threaded - DS110 to DS117



DS110



DS111



DS112



DS113



DS114



DS115



DS116



DS117

- Plated parts for contacting solder
- All tiplets have stainless steel liner brazed to tiplet for better heat transfer
- Entire tiplet is iron, nickel and chrome plated, then tinned
- Chrome plating eliminates need to apply anti-seizing compound on threads
- \* Available bulk packed (100 multiples only); 200 lot minimum order quantity; greater discount offered to orders of 600 lots and above
- To order in bulk, add suffix "B" to Cat. No. eg: DS112B
- **IMPORTANT:** Use only Weller soldering tiplets. Use of non-Weller components may void product warranty if the non-Weller component causes damage to the unit

Desoldering Station (Iron)	Standard Head	Alternate Head	Tiplot Style
DS2000ESD, DS700M (DS1201ESD, DS1201)	DS219T DS229	- DS219, DSH219	Tapered Threaded
DS800 (DS1203A)	DS229 DSH219	- DS219	Tapered Threaded
DS700M (DS1201, DS1201ESD)	DS219T DS229	- DS219, DSH219	Tapered Threaded
DS600 (DS601P)	DS218T DS228	- DS218, DS217	Tapered Threaded
DS500 E (DS501)	DS229 DS219	- DSH219	Tapered Threaded
DS200/DS200K (DS1204A)	DS229	-	Threaded
DS100 (DS102, DS501)	DS227 DS217	- DS218	Tapered Threaded

Cat. No.	UPC No.	Out. Diam.		In. Diam.		Reach		Shelf Pk. Wt.		Shelf Pack
		Inch	mm	Inch	mm	Inch	mm	lb	kg	
DS110	037103474384	0.062	1.52	0.024	0.63	0.50	12.70	1.50	0.68	5
DS111	037103474391	0.093	2.28	0.024	0.63	0.50	12.70	1.50	0.68	5
DS112*	037103474414	0.078	1.93	0.031	0.91	0.50	12.70	1.50	0.68	5
DS113*	037103474445	0.093	2.48	0.046	1.16	0.50	12.70	1.50	0.68	5
DS114*	037103474452	0.125	3.25	0.073	1.80	0.50	12.70	1.50	0.68	5
DS115	037103474476	0.062	1.52	0.024	0.63	0.75	19.05	1.50	0.68	5
DS116	037103474490	0.093	2.48	0.043	1.14	0.75	19.05	1.50	0.68	5
DS117	037103474513	0.093	2.28	0.024	0.63	0.75	19.05	1.50	0.68	5

## Threaded - DSH110 to DSH114

- Presently used solely on DS1203, DS1203A, DS1204A high mass desoldering tool (DS800 and DS200/DS200K)
- High mass tiptlets hold more heat than standard tiptlets
- Can transfer more heat to handle heavy multi-layer P.C. boards
- Makes desoldering faster...less chance of burning P.C. board
- Iron, nickel and chrome plated, then tinned tiptlets; chrome plating protects tiptlets from oxidation and prevents solder from creeping up outside of tiptlet
- **IMPORTANT:** Use only Weller soldering tiptlets. Use of non-Weller components may void product warranty if the non-Weller component causes damage to the unit

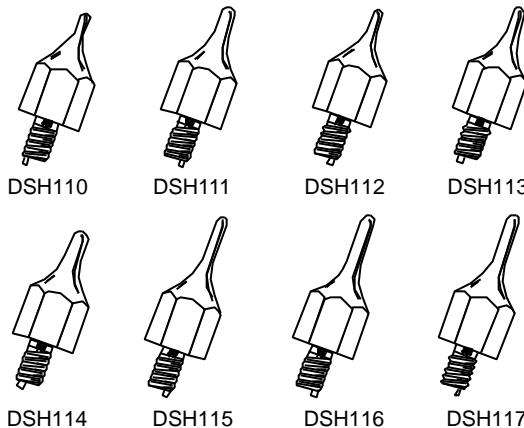

Cat. No.	UPC No.	Out. Diam.		In. Diam.		Reach		Shelf Pk. Wt.		Shelf Pack
		Inch	mm	Inch	mm	Inch	mm	lb	kg	
DSH110	037103593139	0.06	1.52	0.02	0.63	0.75	19.05	0.20	.09	5
DSH111	037103593269	0.09	2.28	0.02	0.63	0.75	19.05	0.20	.09	5
DSH112	037103593153	0.07	1.93	0.03	0.91	0.75	19.05	0.20	.09	5
DSH113	037103593160	0.09	2.48	0.04	1.14	0.75	19.05	0.20	.09	5
DSH114	037103593177	0.12	3.17	0.07	1.80	0.75	19.05	0.20	.09	5
DSH115	037103046420	0.062	1.52	0.024	0.63	0.75	19.05	0.20	.09	5
DSH116	037103046437	0.093	2.48	0.043	1.14	0.75	19.05	0.20	.09	5
DSH117	037103046444	0.093	2.48	0.024	0.63	0.75	19.05	0.20	.09	5

## Tapered - DS110T to DS117T

- Plated parts for contacting solder
- All tiptlets have stainless steel liner brazed to tiptlet for better heat transfer
- Iron, nickel and chrome plated, then tinned tiptlet
- **IMPORTANT:** Use only Weller soldering tiptlets. Use of non-Weller components may void product warranty if the non-Weller component causes damage to the unit

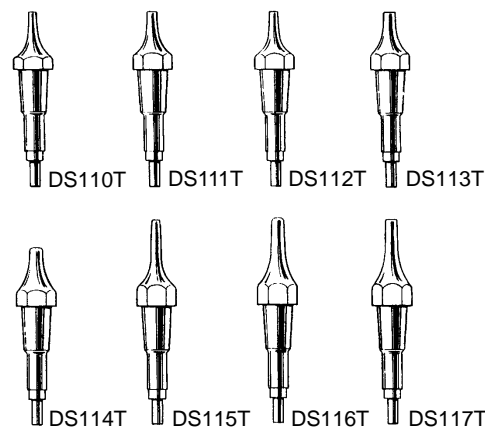

Cat. No.	UPC No.	Out. Diam.		In. Diam.		Reach		Shelf Pk. Wt.		Shelf Pack
		Inch	mm	Inch	mm	Inch	mm	lb	kg	
DS110T	037103479839	0.062	1.52	0.024	0.63	0.50	12.70	0.20	.09	1
DS111T	037103479846	0.093	2.28	0.024	0.63	0.50	12.70	0.20	.09	1
DS112T	037103479853	0.078	1.93	0.031	0.91	0.50	12.70	0.20	.09	1
DS113T	037103479860	0.093	2.48	0.046	1.16	0.50	12.70	0.20	.09	1
DS114T	037103479877	0.125	3.17	0.073	1.80	0.50	12.70	0.20	.09	1
DS115T	037103479884	0.062	1.52	0.024	0.63	0.75	19.05	0.20	.09	1
DS116T	037103479891	0.093	2.48	0.043	1.14	0.75	19.05	0.20	.09	1
DS117T	037103479907	0.093	2.28	0.024	0.63	0.75	19.05	0.20	.09	1

## Threaded - DST1 to DST6 for DS40P, DS60, DSTCP

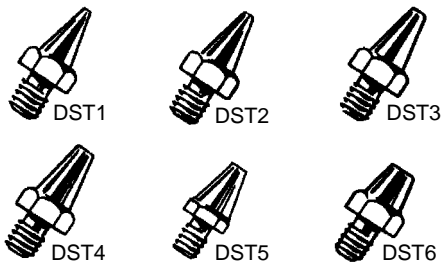

- Plated parts for contacting solder
- Nickel plated tiptlets
- \* Available bulk packed (100 multiples only)
- Packaged 1 tip per card, 10 cards per box
- May be used with DS100, but with possibility of reduced tip life
- **IMPORTANT:** Use only Weller soldering tiptlets. Use of non-Weller components may void product warranty if the non-Weller component causes damage to the unit

Cat. No.	UPC No.	Out. Diam.		In. Diam.		Reach		Shelf Pk. Wt.		Shelf Pack
		Inch	mm	Inch	mm	Inch	mm	lb	kg	
DST1*	037103472090	0.076	1.98	0.038	0.96	0.50	12.70	0.15	.07	10
DST2*	037103472366	0.096	2.41	0.046	1.16	0.50	12.70	0.15	.07	10
DST3*	037103472465	0.125	3.17	0.055	1.49	0.50	12.70	0.15	.07	10
DST4*	037103472571	0.136	3.42	0.062	1.60	0.50	12.70	0.15	.07	10
DST5*	037103472779	0.154	3.93	0.078	1.98	0.50	12.70	0.15	.07	10
DST6*	037103472960	0.171	4.31	0.093	2.28	0.37	9.52	0.15	.07	10

## WDT series tiptlets for manual (WDP) desoldering pumps



- Standard and antistatic versions available
- Standard has Teflon\* tip, antistatic (suffix "A") has carbon tip
- Tips screw into body of manual desoldering pump to ensure maintenance of strong vacuum
- \*Teflon is a Registered Trademark of DuPont

Cat. No.	UPC No.	Description	Shelf Pack Wt.		Shelf Pack
			lb	kg	
WDT07	037103480651	Replacement tip .07"	0.25	0.11	12
WDT07A	037103480675	Replacement tip .07" Antistatic	0.25	0.11	12
WDT12	037103480644	Replacement tip .12"	0.31	0.14	12
WDT12A	037103480668	Replacement tip .12" Antistatic	0.31	0.14	12

## Tiptlets for 5098AS desoldering pistol and 5088 desoldering iron

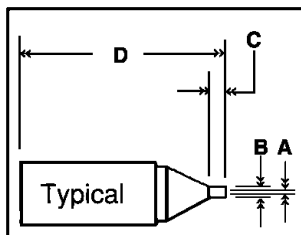

- Machined from special Ungar® Alloy #24
- Highly resistant to abrasion and erosion by solder
- Superior wear characteristics when compared to ordinary copper or composite type tips
- Plated to prevent corrosion

Cat. No.	UPC No.	A		B		C		D		Shelf Pk. Wt.		Shelf Pack
		Inch	mm	Inch	mm	Inch	mm	Inch	mm	lb	kg	
4005	037103059840	.032	0.81	.060	1.52	0.12	3.05	1.312	33.32	.027	0.12	1
4006	037103059857	.040	1.02	.080	2.03	0.12	3.05	1.312	33.32	.027	0.12	1
4007	037103059864	.062	1.57	.100	2.54	0.12	3.05	1.312	33.32	.027	0.12	1
4008	037103059871	.089	2.26	.120	3.05	0.12	3.05	1.312	33.32	.027	0.12	1
4009	037103059888	.062	1.57	.100	2.54	0.37	9.40	1.562	39.67	.026	0.11	1
4012	037103059901	.020	0.51	.040	1.02	0.16	4.06	1.200	30.48	.026	0.11	1

# Desoldering accessories for Surface Mount Technology (SMT)

## SMT tiptets (threaded) for DS200(K), DS500E, and DS800

- Threaded mount tiptet; used with desoldering tools fitted with threaded tiptet
- Makes quick work of flat or quad-pack desoldering w/o risk of damaging pads on circuit board
- Temperature controlled frame simultaneously melts solder of all connected leads
- Activate vacuum switch to gently lift component
- CSF accessories can also be used for soldering pre-tinned flat and quad packs
- Other CSF's can be produced, upon request, to meet other special specifications

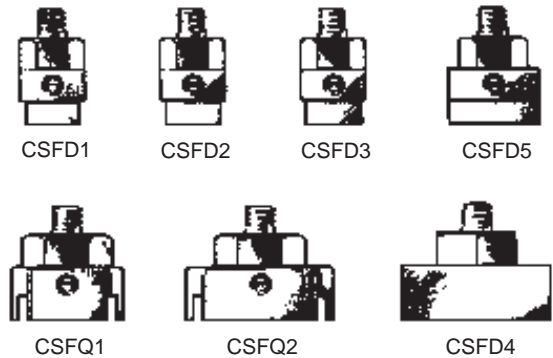
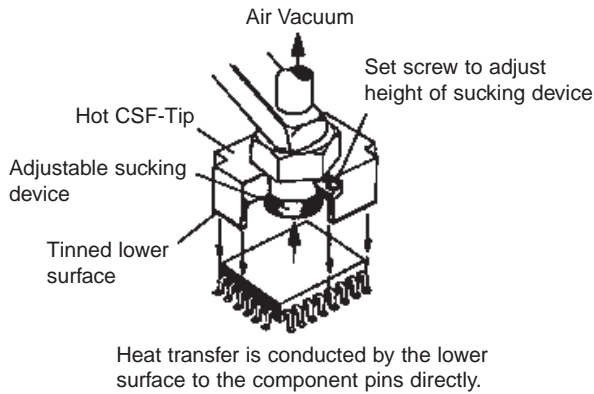

Cat. No.	UPC No.	Description	Shelf Pack Wt.		Shelf Pack
			lb	kg	
CSFD1	037103472144	5.2mm x 10.0mm size chip	.042	.02	1
CSFD2	037103472151	5.8mm x 10.5mm size chip	.042	.02	1
CSFD3	037103472168	6.7mm x 10.0mm size chip	.042	.02	1
CSFD4	037103472182	11.0mm x 26.5mm size chip	.073	.03	1
CSFD5	037103472205	10.0mm x 16.0mm size chip	.049	.02	1
CSFD6	037103593870	9.3mm x 13.0mm size chip	.336	.15	1
CSFD7	037103593887	9.4mm x 10.0mm size chip	.711	.32	1
CSFD8	037103593894	9.8mm x 18.0mm size chip	.711	.32	1
CSFD9	037103593900	10.5mm x 16.0mm size chip	.049	.02	1
CSFD10	037103593917	10.7mm x 18.0mm	.053	.02	1
CSFQ1	037103472236	17.0mm x 17.0mm size chip (4-sided)	.071	.03	1
CSFQ2	037103472243	17.0mm x 23.0mm size chip (4-sided)	.086	.04	1
CSFQ3	037103593924	12.0mm x 12.0mm size chip (4-sided)	.044	.02	1
CSFQ4	037103593818	12.0mm x 14.5mm size chip (4-sided)	.049	.02	1
CSFQ5	037103593825	12.7mm x 12.7mm size chip (4-sided)	.049	.02	1
CSFQ6	037103593832	19.6mm x 19.6mm size chip (4-sided)	.064	.03	1
CSFQI1	037103593849	12.7mm x 12.7mm	.046	.02	1
CSFQI2	037103593856	20.4mm x 20.4mm size chip (4-sided)	.099	.05	1
CSFQI3	037103593863	30.4mm x 30.4mm size chip (4-sided)	.179	.08	1
<b>Replacement parts</b>					
W58713798	037103590268	CSF rubber insert - 10 per bag - small 3mm	.026	.01	1 bag
W58713799	037103590275	CSF rubber insert - 10 per bag - large 6mm	.022	.01	1 bag

## SMT triplets (tapered) for DS2000ESD, DS700M, DS600 stations

- Tapered mount triplet; used with desoldering tools fitted with tapered desoldering head
- Makes quick work of flat or quad-pack desoldering w/o risk of damaging pads on circuit board
- Temperature controlled frame simultaneously melts solder of all connected leads
- Activate vacuum switch to gently lift component
- CSF accessories can also be used for soldering pre-tinned flat and quad packs
- Other CSF's can be quoted, upon request, to meet special specifications
- These are the same as threaded mount, only with a tapered mount

Cat. No.	UPC No.	Description	Shelf Pack Wt.		Shelf Pack
			lb	kg	
CSFD1T	037103473844	5.2mm x 10.0mm size chip	.042	.02	1
CSFD2T	037103473868	5.8mm x 10.5mm size chip	.044	.02	1
CSFD3T	037103473882	6.7mm x 10.0mm size chip	.044	.02	1
CSFD4T	037103473899	11.0mm x 26.5mm size chip	.075	.03	1
CSFD5T	037103473929	10.0mm x 16.0mm size chip	.053	.02	1
CSFQ1T	037103473936	17.0mm x 17.0mm size chip (4-sided)	.086	.04	1
CSFQ2T	037103473943	17.0mm x 23.0mm size chip (4-sided)	.092	.04	1
<b>Replacement parts</b>					
W58713798	037103590268	CSF rubber insert - 10 per bag - small 3mm	.026	.01	1 bag
W58713799	037103590275	CSF rubber insert - 10 per bag - large 6mm	.022	.01	1 bag

## Consumer products WLC100

- On/off switch with "power-on" indicator light
- Variable power control produces 5-40 watts
- Quality lightweight pencil iron
- Cushioned foam grip with replaceable heating element
- Ideal for hobbyists, DIYers and students
- Safety guard iron holder
- Natural sponge tip cleaning pad
- ST3 iron plated copper tip
- ST series tips available
- See list of ST series tips on page Weller 63
- UL listed



Cat. No.	UPC No.	Description	V	W	Hz	Shelf Pack Wt.		Shelf Pack
						lb	kg	
WLC100	037103059963	Complete station w/40w iron	120	40	60	2.5	1.13	1

## Electronic soldering station

- Electronically controlled station with compact design, ideal for the novice soldering buff
- 40 watt soldering pencil, fitted with ETA tip can be used with the full range of Weller ET series tips
- Adjustable temperature from 350°F to 850°F, stable within  $\pm 10^\circ\text{F}$  at idle
- Zero voltage circuit ensures no high voltage spikes or magnetic fields present at tip to damage sensitive components
- 3-wire grounded power cord, UL-recognized
- Lighted On/Off switch; impact-resistant housing and iron handle
- UL listed



Cat. No.	UPC No.	Description	V	W	Hz	Shelf Pack Wt.		Shelf Pack
						lb	kg	
WCC100	037103592415	Complete station w/40w iron	120	60	60	2.5	1.13	1
Replacement parts								
WCC101	037103592538	Soldering iron w/ETA tip	120	42	-	0.50	0.22	1
WCC102	037103592545	Heater assembly for WCC101 iron				-	-	1
WCC103	037103592552	Sensor assembly for WC101 iron				-	-	1
WCC104	037103592569	Sponge				-	-	1
WCC105	037103592576	Spring and funnel assembly				-	-	1

## Controlled-output field soldering irons

- Versatile controlled tool for field servicing
- Operates from suitable batteries or low voltage power source
- Complete with battery clips and 12' fused cord
- Soldering iron comes with a PTA7 tip and heats up to 700°F (370°C). (600°F and 800°F tips optional. See page Weller 61)
- **IMPORTANT:** Use only Weller tips. Use of non-Weller components may void product warranty if non-Weller component causes damage to the unit
- PT series tips listed on page Weller 62
- UL listed



Cat. No.	UPC No.	Description	V	W	Hz	Shelf Pack Wt.		Shelf Pack
						lb	kg	
TCP12P	037103476517	Field soldering iron	12-14	40	-	3.25	1.47	3
TCP24P	037103476524	Field soldering iron	24-28	40	-	3.25	1.47	3

## Solid state soldering gun

- Temperature controlled with fast 6-second heat-up
- Interchangeable power heads give choice of 600°F (315°C) or 700°F (370°C) capability
- Designed for modern solid state electronic work
- Will not damage sensitive components
- Carded
- UL listed



Cat. No.	UPC No.	Description	V	W	Hz	Shelf Pack Wt.		Shelf Pack
						lb	kg	
GT7A	037103473202	Complete gun w/700°F power head & tip	120	150	60	5.25	2.37	6
GT6B	037103472977	Complete gun w/600°F power head & tip	120	150	60	5.25	2.37	6
GT7A3	037103473219	Same as GT7A but w/3-wire cord	120	150	60	5.25	2.37	6
<b>Replacement parts</b>								
7A	037103473196	700°F (370°C) power head w/.187" chisel tip				1.00	0.45	6
6B	037103472830	600°F (315°C) power head w/.125" cone tip				1.00	0.45	6
GT	037103472014	Handle only with trigger & cord				-	-	1
GT3	037103472472	Handle only with trigger & 3-wire cord				-	-	1

## Fiber cutting tool

- Specially developed for fiber manufacturing
- Lightweight, easy to operate
- Makes easy work of cutting through synthetics in forms such as tie cord, rope, carpet backing and textiles
- Rapid heat-up time, (12 seconds to reach 1800°F)
- Designed and built for continuous operation (soldering guns are not)
- Some materials melt at lower temperatures, two standard settings; HIGH, 1800°F-2200°F and LOW, 900°F-1100°F
- Settings offer high efficiency performance plus cutting time reductions of up to 50% with some materials
- Replaceable plug-in power head



Cat. No.	UPC No.	Description	V	W	Hz	Shelf Pack Wt.		Shelf Pack
						lb	kg	
SNG100S	037103028389	Industrial heat gun - Short Tip						
<b>Replacement parts</b>								
SNG101L	037103028358	Power head for SNG100L				-	-	1
SNG101S	037103028365	Power head for SNG100S				-	-	1
SNG105	037103592187	Handle assembly for SNG100L/SNG100S				-	-	1
SNG110	037103592194	Housing for SNG100L/SNG100S				-	-	1
SNG111	037103592200	PC board/switch for SNG100L/SNG100S				-	-	1



## Soldering gun-Universal (140/100 watts)

- All purpose gun
- Fingertip trigger selection of high or low output from instant-heat gun-ready to solder in 6 seconds
- High efficiency tin plated, pure copper tip
- Light illuminates work
- Compact, balanced pistol-grip design
- Available with 2-wire and 3-wire cord
- Soldering hints booklet included
- Tips listed on page Weller 82
- UL listed



Cat. No.	UPC No.	Description	V	W	Hz	Shelf Pack Wt.		Shelf Pack
						lb	kg	
8200	037103475848	Soldering gun	120	140/100	50/60	8.75	3.95	3
82003	037103475855	Soldering gun 3-wire	120	140/100	50/60	17.50	7.91	6
<b>The following is available only to authorized export distributors. Units not VDE or GS approved.</b>								
8200D	037103475978	Soldering gun	240	140	50/60	17.50	7.91	6

## Soldering gun-Professional (260/200 watts)

- Heavy-duty gun
- High output gun w/2-position trigger selection of dual heats
- Heavy gauge, high efficiency, tin plated, copper tip comes up to temperature in 6 seconds
- Balanced pistol-grip design with twin lights to illuminate work
- Available with 2-wire or 3-wire cord
- Complete with soldering hints booklet
- Tips listed on page Weller 82
- UL listed



Cat. No.	UPC No.	Description	V	W	Hz	Shelf Pack Wt.		Shelf Pack
						lb	kg	
D550	037103475411	Soldering gun	120	260/200	50/60	5.00	2.26	3
D5503	037103475435	Soldering gun 3-wire	120	260/200	50/60	10.00	4.52	6
<b>The following is available only to authorized export distributors. Units not VDE or GS approved.</b>								
8250D	037103475992	Soldering gun	240	220	50/60	5.00	2.26	6

## Industrial soldering gun (300/200 watts)



- Reliable new industrial-quality tool
- Highest power output of all our soldering guns:  
300 watts in high trigger position and  
200 watts in low trigger position
- Features nickel-plated copper secondary, heat-resistant thermoplastic housing
- Nickel-plated copper tip
- Heavy-duty grounded cord
- Wide selection of soldering, cutting and smoothing tips available

Cat No.	UPC No.	Description	V	W	Hz	Pack Wt.		Shelf Pack
						lb	kg	
D650	037103079480	Soldering gun	120	300/200	50/60	3.9	1.77	1

## Soldering gun kit-Standard lightweight (75w)



- 7200 soldering gun in plastic case
- Coil of lead-free rosin core solder
- 2 soldering tips and instruction leaflet

Cat No.	UPC No.	Description	V	W	Hz	Shelf Pack Wt.		Shelf Pack
						lb	kg	
7200PK	037103478801	Soldering gun kit	120	75	50/60	10.80	4.88	3

## Soldering gun kit-Universal (140/100 watts)

- 8-piece kit with 8200 soldering gun
- Includes: 1 soldering tip; 1 sealing tip; 1 cutting tip; flux brush; soldering aid tool; coil of lead-free rosin core solder
- Sturdy plastic carrying case
- Soldering hints booklet
- For information on soldering gun, refer to Catalog Number 8200, page Weller 79
- UL listed



Cat. No.	UPC No.	Description	V	W	Hz	Shelf Pack Wt.		Shelf Pack
						lb	kg	
8200PK	037103475862	Soldering gun kit	120	140/100	50/60	12.00	5.42	3
<b>The following is available only to authorized export distributors. Units not VDE or GS approved.</b>								
8200DPK	037103475985	Soldering gun kit	240	140	50/60	12.00	5.42	3

## Soldering gun kit-Professional (260/200 watts)

- 8-piece heavy duty kit with D550 soldering gun
- Includes: 1 soldering tip; 1 sealing tip; 1 cutting tip; flux brush; soldering aid tool; coil of lead-free rosin core solder
- Sturdy plastic carrying case
- Soldering hints booklet
- For information on soldering gun, refer to Catalog Number D550, page Weller 79
- UL listed



Cat. No.	UPC No.	Description	V	W	Hz	Shelf Pack Wt.		Shelf Pack
						lb	kg	
D550PK	037103475428	Soldering gun kit	120	260/200	50/60	13.00	5.88	3
<b>The following is available only to authorized export distributors. Units not VDE or GS approved.</b>								
8250DPK	037103476005	Soldering gun kit	240	220	50/60	13.00	5.88	3

## Replacement tips for soldering guns

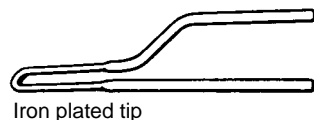

Iron plated tip



Cutting tip



Standard tip



Smoothing tip

- Complete line of cutting, smoothing, standard and tin plated tips, all made of copper, for Weller soldering guns
- **IMPORTANT:** Use only Weller soldering tips. Use of non-Weller components may void product warranty if the non-Weller component causes damage to the unit

Cat. No.	UPC No.	Description	Shelf Pack
<b>Cutting tip</b>			
6110	037103475565	Tip with hex nut for 8200/9200K	6
6130	037103475589	Tip with hex nut for D550	6
6130AN	037103592002	Tip with hex inserts & acorn nuts for D550	6
6150	037103480415	Tip only for 8200/D550	6
<b>Smoothing tip</b>			
6120	037103475572	Tip with hex nut for 8200/9200K	6
6140	037103475596	Tip with hex nut for D550	6
6140AN	037103592019	Tip with acorn nut for D550	6
6160	037103480422	Tip only for 8200/D550	6
<b>Standard tip</b>			
7135	037103475657	Tip only-2 per card for 8200/9200K	6
7135N	037103475664	Tip with hex nut for 8200	6
7235	037103478818	Tip only-2 per card for 7200	6
7250	037103475718	Tip only-2 per card for D550	6
7250AN	037103592026	Tip with acorn nut for D550	6
7250N	037103475725	Tip with hex nut for D550	6
<b>Iron plated tip</b>			
8125	037103475824	Tip only-2 per card for 8200	6
8125N	037103475831	Tip with hex nut for 8200	6
<b>Rope cutting tip</b>			
RCT	037103590237	Rope cutting tip for 8200	6

## Soldering gun accessories and parts

- Soldering gun replacement parts
- Please order part by catalog number and specify gun model number if not apparent within chart

Cat. No.	UPC No.	Description	Shelf Pack
4206	037103475558	Flux brush	1
7194	037103475671	Light-bulb wedge type for N guns	1
7323	037103475749	Switch for single heat models	1
7324	037103475756	Switch for dual heat models	1
7325	037103475763	Tip nuts for models 8100, 8200	12
7417	037103475800	Tip nuts for model D550	1
8200RH	037103475879	Right & left housings for 8200 series	1
D550RH	037103475442	Right & left housings for D550 series	1