



Aluminum Electrolytic Capacitors

Snap Mount ♦ Screw Mount



United Chemi-Con's
Manufacturing Plant is in
Lansing, North Carolina, USA
Nestled in the Blue Ridge
Mountain Range



Table of Contents

United Chemi-Con is publishing this edition of the Lansing Catalog to promote new and updated capacitor series for snap mount and screw mount aluminum electrolytic capacitors that are manufactured in either the North American U.S. facility located in Lansing, North Carolina or in a plant abroad. These capacitor series include 7 snap mount series (3 new and 4 updates), and 7 screw mount series (2 new and 5 updates), includes our toroidal screw mount series that offers outstanding cooling alternatives. In addition to high ripple current capability and long life, these capacitors are offered in a wide range of sizes, ratings, and exterior construction styles including the special UL746C compliant insulation material for sleeves and end disks. All of our capacitor products are RoHS compliant.

This catalog emphasizes the global part numbering system for our capacitor products. *Please carefully review the part numbering system specified for each series before ordering.*

Please contact United Chemi-Con for a printed copy of this 105-page catalog (#9-2018L) or download the PDF located on our website www.chemi-con.com.



Introduction	1
Specifications Guide	2
Group Charts	3
Certifications and Quality Standards	4
 Snap Mount: Snap-in and Straight Pins	
U91D New	5
U92D New	12
U93E New	18
U91F Update	24
U92F Update	31
U92L Update	38
U92X Update	45
 Large Can: Screw Mount Terminals	
U33D New	52
U37D New	63
U33F Update	71
U37F Update	78
U37L Update	85
U37X Update	92
UTOR Update	99
 Metric Conversion Table	Inside Back Cover

In the construction of the components described, the full intent of the specification will be met. United Chemi-Con, however, reserves the right to make, from time to time, such departures from the detail specifications as may be required to permit improvements in the design of its products. Components made under military approvals will be in accordance with the approval requirements. The information included herein is believed to be accurate and reliable. However, United Chemi-Con assumes no responsibility for its use, nor for any infringements of patents or other rights of third parties which may result from its use.

Specifications Guide

Series	Page No.	Series Features	RoHS Compliant	Terminal Type	Maximum Temperature (C°)	Voltage Range (V)	Capacitance Range (μF)	Endurance (Hours + R*)
U91D	5	High ripple design, 2,000 hours at +105°C, wide voltage range, external material options for sleeve and end disk, various pin options	○	Snap-in, Straight Standoff	+105°C	25~550	220~120,000	2,000 + R
U92D	12	High ripple design, 2,000 hours at +85°C, high voltage range, external material options for sleeve and end disk, various pin options	○	Snap-in, Straight Standoff	+85°C	350~550	270~3,300	2,000 + R
U93E	18	High ripple design, 3,000 or 5,000 hours life at +105°C, high voltage, external material options for sleeve and end disk, pin options	○	Snap-in, Straight Standoff	+105°C	350~550	220~3,300	3,000 + R or 5,000 + R
U91F	24	High ripple design, 5,000 hours at +105°C, standard PVC sleeve with PPE end disk (other sleeve/end disk types available), pin options	○	Snap-in, Straight Standoff	+105°C	350~500	120~2,700	5,000 + R
U92F	31	High ripple design, 5,000 hours at +85°C, standard PVC sleeve with PPE end disk (other sleeve/end disk types available), pin options	○	Snap-in, Straight Standoff	+85°C	350~500	180~3,300	5,000 + R
U92L	38	High ripple design, 10,000 hours at +85°C, standard PVC sleeve with PPE end disk (other sleeve/end disk types available), pin options	○	Snap-in, Straight Standoff	+85°C	350~500	150~3,300	10,000 + R
U92X	45	High ripple design, 15,000 hours at +85°C, standard PVC sleeve with PPE end disk (other sleeve/end disk types available), pin options	○	Snap-in, Straight Standoff	+85°C	350~500	150~3,300	15,000 + R
U33D	52	Ideal design for inverter applications, wide voltage range, 2,000 hours at +105°C, external material options for sleeve and end disk	○	Screw Mount	+105°C	25~550	560~1,000,000	2,000 + R
U37D	63	Ideal design for inverter applications, high voltage range, 2,000 hours at +85°C, external material options for sleeve and end disk	○	Screw Mount	+85°C	350~550	1,000~22,000	2,000 + R
U33F	71	High ripple design and long life for inverter applications, 5,000 hours at +105°C, high voltage, sleeve and end disk material options	○	Screw Mount	+105°C	350~500	1,200~15,000	5,000 + R
U37F	78	High ripple design and long life for inverter applications, 5,000 hours at +85°C, high voltage, sleeve and end disk material options	○	Screw Mount	+85°C	350~500	1,500~22,000	5,000 + R
U37L	85	High ripple design and long life for inverter applications, 10,000 hours at +85°C, high voltage, sleeve and end disk material options	○	Screw Mount	+85°C	350~500	1,500~18,000	10,000 + R
U37X	92	High ripple design and long life for inverter applications, 15,000 hours at +85°C, high voltage, sleeve and end disk material options	○	Screw Mount	+85°C	350~500	1,200~18,000	15,000 + R
UTOR	99	Toroidal design, low thermal resistance, forced air or heat sink cooling, standard PVC sleeve (or optional PET sleeve) with end disk	○	Screw Mount	+105°C	350~500	680~10,000	5,000 + R

* +R = With rated ripple current applied.

Group Charts

Snap-In

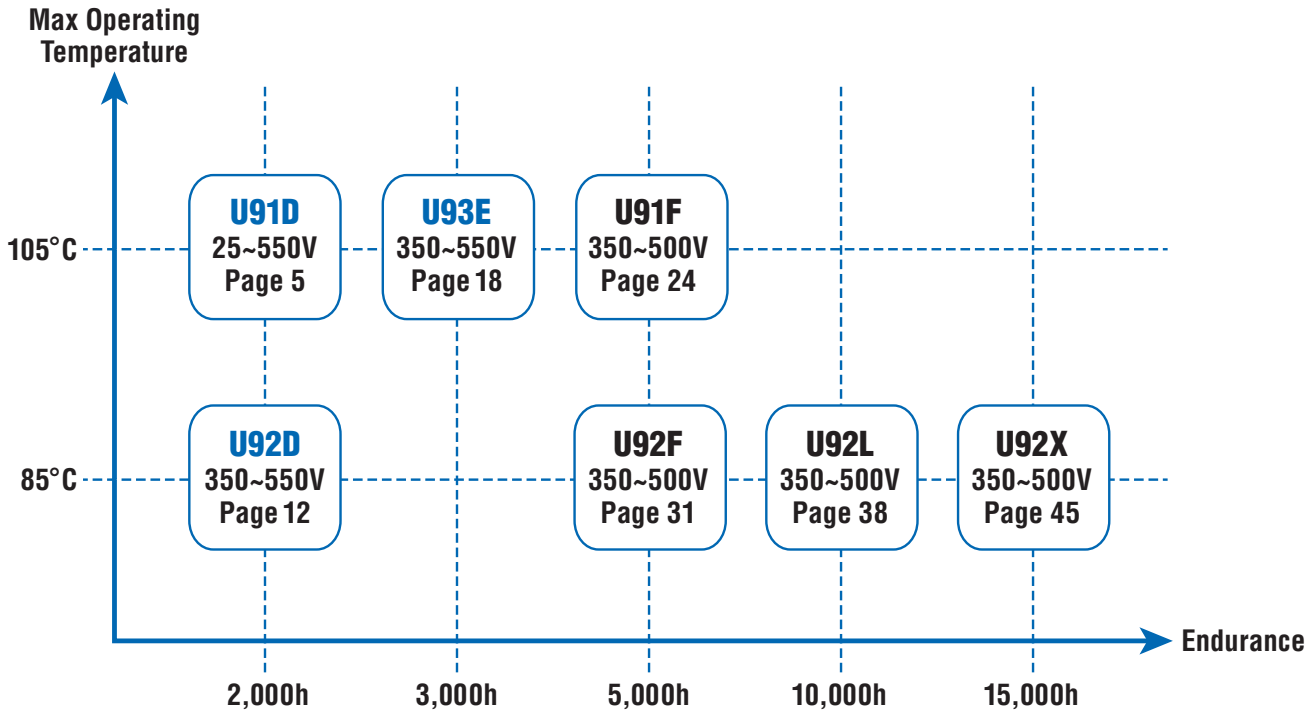

Screw Mount

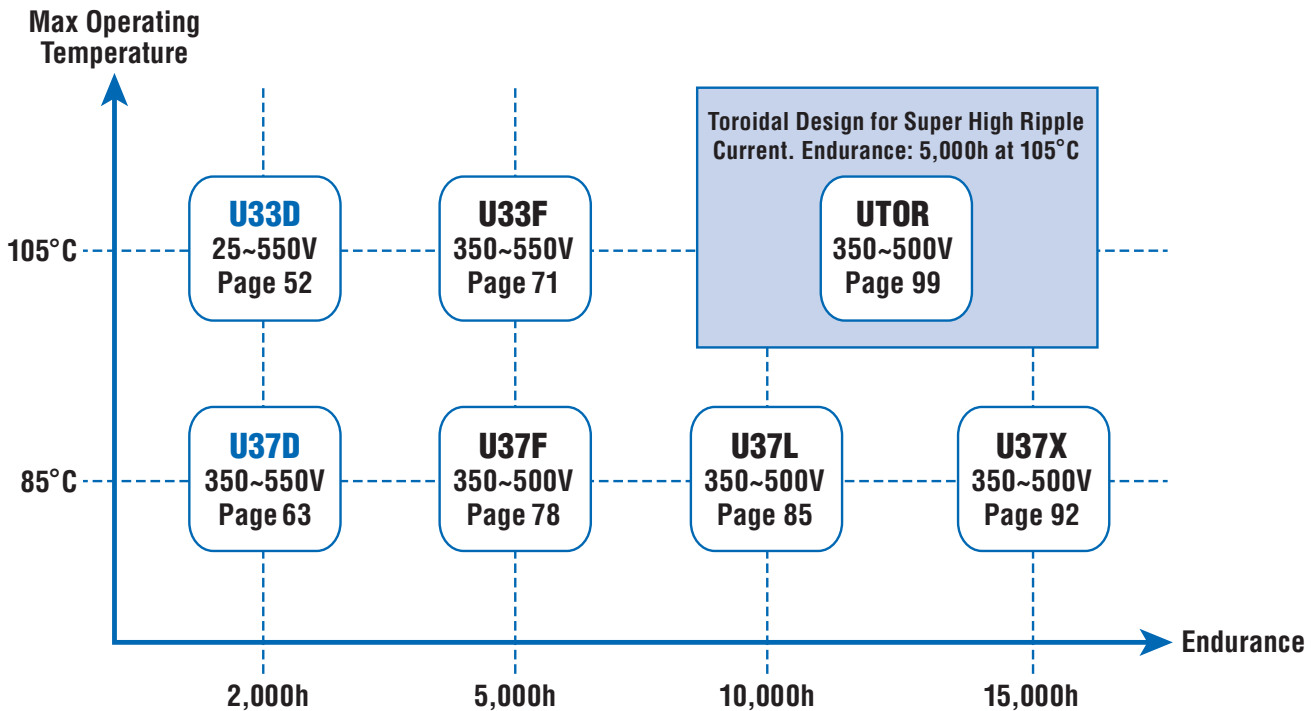



Certifications and International Quality Standards

- Chemi-Con Group has acquired ISO14001 certifications at all production sites as part of our ongoing Environmental Management System. Using ISO14001 can provide assurance to company management and employees as well as corporate stakeholders that environmental impact is being measured and improved.
- Chemi-Con Group has ISO9001 certification. ISO9001 is an independent third-party organization that certifies that we meet the fundamentals of quality management systems and the needs of our customers and stakeholders while meeting statutory and regulatory requirements related to our products and services.
- Chemi-Con Group is in compliance with the automotive industry's most widely used international standards for quality management, IATF16949 and/or TS16946. (International Automotive Task Force)

Exterior Insulation Materials Compliance

The UL746C compliant exterior polymeric materials are available for United Chemi-Con Aluminum Electrolytic Capacitors. Please contact us for more information (UL File E342569).

U91D Series



U91D
SNAP MOUNT 105°C

- Snap Mount
- Specific Design For Higher Ripple Current
- 25 to 550VDC Voltage Range
- RoHS Compliant
- +105°C Maximum Temperature
- 2,000 Hours Lifetime at +105°C



The U91D series is a high temperature snap-in series specifically designed for higher ripple current capability. The U91D capacitors have an endurance rating of 2,000 hours at +105°C with the rated ripple current applied. All the U91D series capacitors are RoHS compliant and offered in a variety of sizes, with or without a PPE end disk, and encased in a standard PVC sleeve or an optional PET sleeve. UL746C compliant exterior insulation material for sleeve and end disk is also available. Snap-in terminals (2, 4 or 5-pin configurations) are available as standard or optional styles depending on case size. Straight standoff terminals (5-pin configuration) are an option for the 40, 45 and 50mm can diameters.

Summary of Specifications

- PC board snap-in or straight standoff terminals available as standard or optional styles depending on pin styles and case size.
- Capacitance range: 220 to 120,000µF.
- Voltage range: 25 to 550VDC.
- Category temperature range: -40°C to +105°C.
- Leakage current: $3\sqrt{CV}$ (µA) or 3mA, whichever is smaller, after 5 minutes at +25°C.
- Standard capacitance tolerance: ±20%
- Nominal case size (D × L): 35 × 50mm to 50 × 105mm.
- Rated lifetime: 2,000 hours at +105°C with the rated ripple current applied.

U91D Series

U91D Specifications - Snap Mount

Category Temperature Range	- 40 to +105°C																																														
Rated Voltage Range	25 to 550VDC																																														
Capacitance Range	220 to 120,000μF at +25°C, 120Hz																																														
Capacitance Tolerance	±20% (M) at +25°C, 120Hz																																														
Leakage Current	$I = 3\sqrt{CV}$ (μA) or 3mA, whichever is smaller, after 5 minutes at +25°C. Where I = Max. leakage current (μA), C = Nominal capacitance (μF) and V = Rated voltage (V)																																														
Dissipation Factor (Tan δ)	At +25°C, 120Hz <table border="1" style="margin-left: 20px;"> <tr> <td>Rated Voltage (V)</td> <td>25-400</td> <td>450-550</td> </tr> <tr> <td>Tan δ (DF) Max.</td> <td>0.15</td> <td>0.20</td> </tr> </table>						Rated Voltage (V)	25-400	450-550	Tan δ (DF) Max.	0.15	0.20																																			
Rated Voltage (V)	25-400	450-550																																													
Tan δ (DF) Max.	0.15	0.20																																													
Low Temperature Characteristics	At 120Hz, impedance (Z) ratio between the - 40°C value and +25°C value shall not exceed the values given below. <table border="1" style="margin-left: 20px;"> <tr> <td>Rated Voltage (V)</td> <td>25</td> <td>50</td> <td>100</td> <td>200-400</td> <td>450-550</td> </tr> <tr> <td>Z(-40°C)/Z(+25°C)</td> <td>10</td> <td>6</td> <td>5</td> <td>4</td> <td>8</td> </tr> </table>						Rated Voltage (V)	25	50	100	200-400	450-550	Z(-40°C)/Z(+25°C)	10	6	5	4	8																													
Rated Voltage (V)	25	50	100	200-400	450-550																																										
Z(-40°C)/Z(+25°C)	10	6	5	4	8																																										
Rated Ripple Current Multipliers	Ambient Temperature (°C) <table border="1" style="margin-left: 20px;"> <tr> <td>+65°C</td> <td>+85°C</td> <td>+105°C</td> </tr> <tr> <td>2.82</td> <td>1.73</td> <td>1.00</td> </tr> </table> Frequency (Hz) <table border="1" style="margin-left: 20px;"> <tr> <td>DC Rated Voltage</td> <td>50Hz</td> <td>120Hz</td> <td>300Hz</td> <td>1kHz</td> <td>10kHz</td> <td>100kHz</td> </tr> <tr> <td>25-50V</td> <td>0.95</td> <td>1.00</td> <td>1.03</td> <td>1.05</td> <td>1.08</td> <td>1.08</td> </tr> <tr> <td>100-300V</td> <td>0.81</td> <td>1.00</td> <td>1.17</td> <td>1.32</td> <td>1.45</td> <td>1.50</td> </tr> <tr> <td>350-450V</td> <td>0.77</td> <td>1.00</td> <td>1.16</td> <td>1.30</td> <td>1.41</td> <td>1.43</td> </tr> <tr> <td>500-550V</td> <td>0.70</td> <td>1.00</td> <td>1.16</td> <td>1.30</td> <td>1.41</td> <td>1.43</td> </tr> </table>						+65°C	+85°C	+105°C	2.82	1.73	1.00	DC Rated Voltage	50Hz	120Hz	300Hz	1kHz	10kHz	100kHz	25-50V	0.95	1.00	1.03	1.05	1.08	1.08	100-300V	0.81	1.00	1.17	1.32	1.45	1.50	350-450V	0.77	1.00	1.16	1.30	1.41	1.43	500-550V	0.70	1.00	1.16	1.30	1.41	1.43
+65°C	+85°C	+105°C																																													
2.82	1.73	1.00																																													
DC Rated Voltage	50Hz	120Hz	300Hz	1kHz	10kHz	100kHz																																									
25-50V	0.95	1.00	1.03	1.05	1.08	1.08																																									
100-300V	0.81	1.00	1.17	1.32	1.45	1.50																																									
350-450V	0.77	1.00	1.16	1.30	1.41	1.43																																									
500-550V	0.70	1.00	1.16	1.30	1.41	1.43																																									
Endurance (Load Life)	The following specifications shall be satisfied when the capacitors are restored to +25°C after subjecting them to DC voltage for 2,000 hours at +105°C with the rated ripple current applied. The sum of the DC voltage and peak AC voltage must not exceed the full rated voltage of the capacitors. Capacitance change: ≤ ±20% of initial measured value Tan δ (DF) : ≤ 200% of initial specified value Leakage current : ≤ initial specified value																																														
Shelf Life	The following specifications shall be satisfied when the capacitors are restored to +25°C after exposing them for 1,000 hours at +105°C without voltage applied. The rated voltage shall be applied to the capacitors for a minimum of 30 minutes, at least 24 hours and not more than 48 hours before the measurements. Capacitance change: ≤ ±20% of initial measured value Tan δ (DF) : ≤ 150% of initial specified value Leakage current : ≤ initial specified value																																														
Custom Designs	Custom CV values per case size and termination type may be available upon request. Contact appropriate representative with specific requirements.																																														

U91D Series

Diagram of Dimensions - Snap Mount

Snap Mount

VSN Snap-in $\varnothing 35$ standard
VNN Snap-in $\varnothing 35$ optional

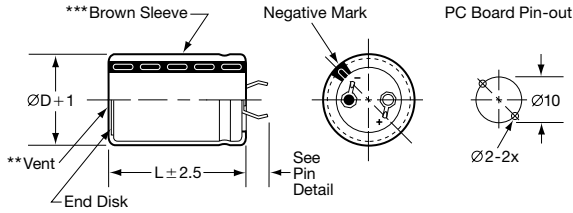

Snap Mount

Unit: mm

VND Snap-in $\varnothing 35$ and $\varnothing 40$ standard; $\varnothing 45$ optional
VSD Snap-in $\varnothing 35$ and $\varnothing 40$ optional

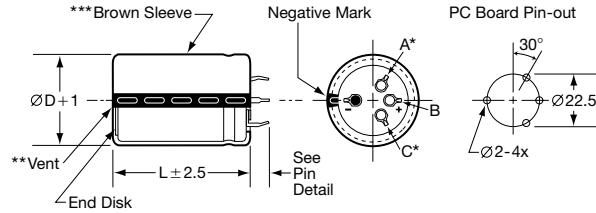

VEN Snap-in $\varnothing 35$ optional

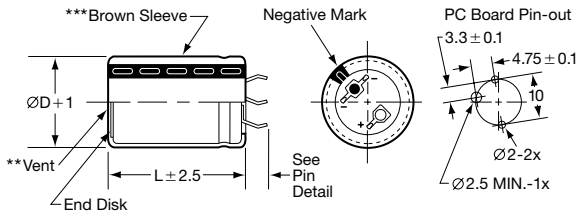

VNT Snap-in $\varnothing 45$ and $\varnothing 50$ standard

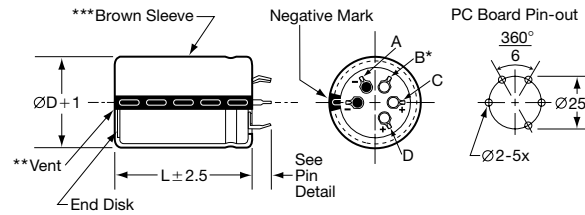

VS, VE & VN Snap-in Pin Dimensions

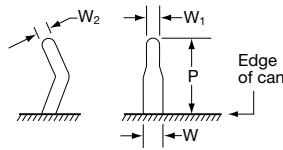

Type	P	W	W ₁	W ₂
VSN $\varnothing 35$	3.5 ± 0.5			
VNN $\varnothing 35$	5.8 ± 1.0			
VEN $\varnothing 35$	4.0 ± 0.5	1.5 ± 0.2	0.8 ± 0.1	0.8 ± 0.1
VSD $\varnothing 35-\varnothing 40$	3.5 ± 1.0			
VND $\varnothing 35-\varnothing 45$	5.8 ± 1.0			
VNT $\varnothing 45-\varnothing 50$	5.8 ± 1.0			

Straight Pin Mount

VQT Straight Standoff $\varnothing 40$, $\varnothing 45$ and $\varnothing 50$ optional

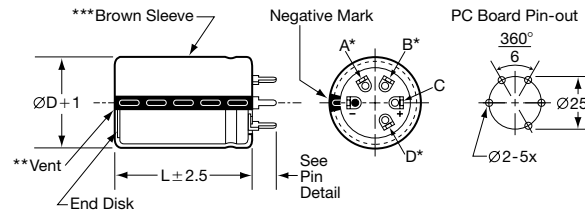

VQ Straight Standoff Pin Dimensions

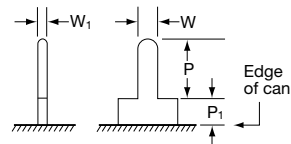

Type	P	P ₁	W	W ₁
Standoff Pin (VQ)	3.75 ± 1.0	2.0 max.	1.5 ± 0.1	0.7 ± 0.2

CAUTION:

- * Use the blank terminals for mechanical support only. The blank terminals must not be connected to a solder trace on the PC board but be electrically isolated from the negative and positive terminals.
- ** The vent may be located either on the bottom or side of the can.
- *** The brown sleeve with gray stripe negative pin indicator is standard. Also note in some cases, the sleeve color may change slightly due to the operating conditions, however, the discoloration will not impair capacitor function.

U91D Series

Part Numbering System for U91D Series When ordering, always specify complete 18-field global part number.

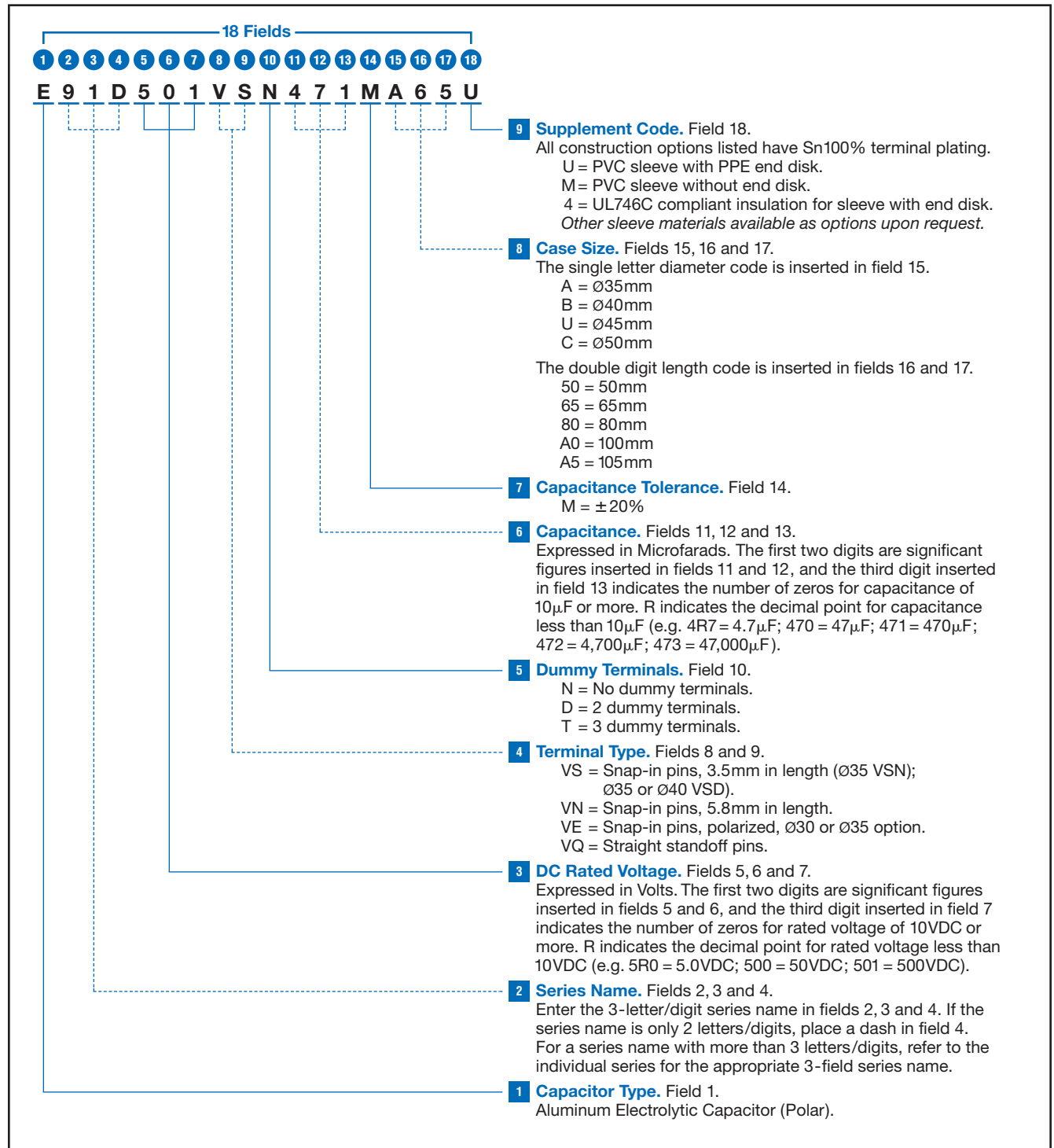

U91D
SNAP MOUNT 105°C

U91D Series

Standard Voltage Ratings - Snap Mount

Rated Voltage (WVDC)	Capacitance (μF)	Global Part Number†	Nominal Case Size* D × L (mm)	Case Size Code	Maximum ESR (Ω) at +25°C, 120Hz	Rated Ripple Current (A rms) at +105°C, 120Hz
25 Volts 32 Volts Surge	39,000	E91D250VSN393MA50U	35 × 50	A50	0.019	7.7
	56,000	E91D250VSN563MA65U	35 × 65	A65	0.015	9.5
	68,000	E91D250VND683MA80U	35 × 80	A80	0.012	11.2
	82,000	E91D250VND823MAA0U	35 × 100	AA0	0.011	13.3
	47,000	E91D250VND473MB50U	40 × 50	B50	0.021	7.8
	68,000	E91D250VND683MB65U	40 × 65	B65	0.016	9.8
	82,000	E91D250VND823MB80U	40 × 80	B80	0.013	11.5
	120,000	E91D250VND124MBA0U	40 × 100	BA0	0.011	13.8
50 Volts 63 Volts Surge	15,000	E91D500VSN153MA50U	35 × 50	A50	0.027	6.6
	18,000	E91D500VSN183MA65U	35 × 65	A65	0.022	7.8
	27,000	E91D500VND273MA80U	35 × 80	A80	0.016	9.8
	33,000	E91D500VND333MAA0U	35 × 100	AA0	0.013	12.0
	18,000	E91D500VND183MB50U	40 × 50	B50	0.031	6.5
	27,000	E91D500VND273MB65U	40 × 65	B65	0.021	8.6
	33,000	E91D500VND333MB80U	40 × 80	B80	0.017	10.2
	39,000	E91D500VND393MBA0U	40 × 100	BA0	0.014	12.0
100 Volts 125 Volts Surge	4,700	E91D101VSN472MA50U	35 × 50	A50	0.042	5.2
	6,800	E91D101VSN682MA65U	35 × 65	A65	0.029	6.8
	8,200	E91D101VND822MA80U	35 × 80	A80	0.024	8.0
	10,000	E91D101VND103MAA0U	35 × 100	AA0	0.020	9.8
	5,600	E91D101VND562MB50U	40 × 50	B50	0.036	6.0
	8,200	E91D101VND822MB65U	40 × 65	B65	0.029	7.2
	10,000	E91D101VND103MB80U	40 × 80	B80	0.024	8.5
	15,000	E91D101VND153MBA0U	40 × 100	BA0	0.019	10.6
200 Volts 250 Volts Surge	1,800	E91D201VSN182MA50U	35 × 50	A50	0.066	4.2
	2,200	E91D201VSN222MA65U	35 × 65	A65	0.054	5.0
	3,300	E91D201VND332MA80U	35 × 80	A80	0.039	6.3
	3,900	E91D201VND392MAA0U	35 × 100	AA0	0.033	7.6
	2,200	E91D201VND222MB50U	40 × 50	B50	0.072	4.2
	3,300	E91D201VND332MB65U	40 × 65	B65	0.048	5.6
	3,900	E91D201VND392MB80U	40 × 80	B80	0.041	6.5
	5,600	E91D201VND562MBA0U	40 × 100	BA0	0.032	8.0
250 Volts 300 Volts Surge	1,000	E91D251VSN102MA40U	35 × 40	A40	0.092	3.2
	1,200	E91D251VSN122MA50U	35 × 50	A50	0.076	3.9
	1,800	E91D251VSN182MA65U	35 × 65	A65	0.051	5.2
	2,200	E91D251VND222MA80U	35 × 80	A80	0.042	6.1
	1,800	E91D251VND182MB50U	40 × 50	B50	0.055	4.8
	2,200	E91D251VND222MB65U	40 × 65	B65	0.045	5.8
	3,300	E91D251VND332MB80U	40 × 80	B80	0.030	7.6
	3,900	E91D251VND392MBA0U	40 × 100	BA0	0.026	9.0
350 Volts 400 Volts Surge	820	E91D351VSN821MA50U	35 × 50	A50	0.112	3.2
	1,200	E91D351VSN122MA65U	35 × 65	A65	0.076	4.2
	1,500	E91D351VND152MA80U	35 × 80	A80	0.061	5.0
	1,800	E91D351VND182MAA0U	35 × 100	AA0	0.051	6.1
	1,000	E91D351VND102MB50U	40 × 50	B50	0.100	3.6
	1,500	E91D351VND152MB65U	40 × 65	B65	0.066	4.8
	1,800	E91D351VND182MB80U	40 × 80	B80	0.055	5.6
	2,200	E91D351VND222MBA0U	40 × 100	BA0	0.045	6.8
	1,000	E91D351VNT102MU50U	45 × 50	U50	0.107	3.7
	1,500	E91D351VNT152MU65U	45 × 65	U65	0.072	4.9
	1,800	E91D351VNT182MU80U	45 × 80	U80	0.060	5.8
	2,700	E91D351VNT272MUA5U	45 × 105	UA5	0.040	7.9

† For construction and terminal options, refer to the part numbering system for descriptions and codes.

* Refer to diagram of dimensions for detailed case size specifications.

U91D Series

Standard Voltage Ratings - Snap Mount

Rated Voltage (WVDC)	Capacitance (µF)	Global Part Number†	Nominal Case Size* D × L (mm)	Case Size Code	Maximum ESR (Ω) at +25°C, 120Hz	Rated Ripple Current (A rms) at +105°C, 120Hz
350 Volts 400 Volts Surge	1,200	E91D351VNT122MC50U	50 × 50	C50	0.092	4.1
	1,800	E91D351VNT182MC65U	50 × 65	C65	0.066	5.2
	2,200	E91D351VNT222MC80U	50 × 80	C80	0.054	6.3
	3,300	E91D351VNT332MCA5U	50 × 105	CA5	0.036	8.7
400 Volts 450 Volts Surge	680	E91D401VSN681MA50U	35 × 50	A50	0.129	3.0
	1,000	E91D401VSN102MA65U	35 × 65	A65	0.088	3.9
	1,200	E91D401VND122MA80U	35 × 80	A80	0.073	4.6
	1,500	E91D401VND152MAA0U	35 × 100	AA0	0.058	5.7
	820	E91D401VND821MB50U	40 × 50	B50	0.112	3.4
	1,200	E91D401VND122MB65U	40 × 65	B65	0.076	4.5
	1,500	E91D401VND152MB80U	40 × 80	B80	0.061	5.3
	2,200	E91D401VND222MBA0U	40 × 100	BA0	0.042	7.1
	820	E91D401VNT821MU50U	45 × 50	U50	0.121	3.5
	1,200	E91D401VNT122MU65U	45 × 65	U65	0.083	4.5
	1,500	E91D401VNT152MU80U	45 × 80	U80	0.066	5.5
	2,200	E91D401VNT222MUA5U	45 × 105	UA5	0.045	7.4
	1,000	E91D401VNT102MC50U	50 × 50	C50	0.101	3.9
	1,500	E91D401VNT152MC65U	50 × 65	C65	0.074	5.0
	2,200	E91D401VNT222MC80U	50 × 80	C80	0.056	6.3
	2,700	E91D401VNT272MCA5U	50 × 105	CA5	0.041	8.2
450 Volts 500 Volts Surge	560	E91D451VSN561MA50U	35 × 50	A50	0.149	2.8
	680	E91D451VSN681MA65U	35 × 65	A65	0.123	3.3
	1,000	E91D451VND102MA80U	35 × 80	A80	0.084	4.3
	1,200	E91D451VND122MAA0U	35 × 100	AA0	0.070	5.2
	680	E91D451VND681MB50U	40 × 50	B50	0.135	3.1
	1,000	E91D451VND102MB65U	40 × 65	B65	0.092	4.1
	1,200	E91D451VND122MB80U	40 × 80	B80	0.076	4.8
	1,500	E91D451VND152MBA0U	40 × 100	BA0	0.061	5.8
	680	E91D451VNT681MU50U	45 × 50	U50	0.135	3.3
	1,000	E91D451VNT102MU65U	45 × 65	U65	0.092	4.3
	1,200	E91D451VNT122MU80U	45 × 80	U80	0.076	5.1
	1,800	E91D451VNT182MUA5U	45 × 105	UA5	0.051	7.0
	820	E91D451VNT821MC50U	50 × 50	C50	0.121	3.6
	1,200	E91D451VNT122MC65U	50 × 65	C65	0.083	4.7
	1,800	E91D451VNT182MC80U	50 × 80	C80	0.055	6.3
	2,200	E91D451VNT222MCA5U	50 × 105	CA5	0.045	7.8
500 Volts 550 Volts Surge	330	E91D501VSN331MA50U	35 × 50	A50	0.241	2.2
	470	E91D501VSN471MA65U	35 × 65	A65	0.169	2.8
	560	E91D501VND561MA80U	35 × 80	A80	0.142	3.3
	820	E91D501VND821MAA0U	35 × 100	AA0	0.097	4.4
	390	E91D501VND391MB50U	40 × 50	B50	0.214	2.5
	560	E91D501VND561MB65U	40 × 65	B65	0.149	3.2
	820	E91D501VND821MB80U	40 × 80	B80	0.102	4.1
	1,000	E91D501VND102MBA0U	40 × 100	BA0	0.084	5.0
	560	E91D501VNT561MU50U	45 × 50	U50	0.156	3.0
	680	E91D501VNT681MU65U	45 × 65	U65	0.129	3.6
	820	E91D501VNT821MU80U	45 × 80	U80	0.107	4.3
	1,000	E91D501VNT102MUA5U	45 × 105	UA5	0.088	5.3
	680	E91D501VNT681MC50U	50 × 50	C50	0.135	3.4
	820	E91D501VNT821MC65U	50 × 65	C65	0.112	4.0
	1,200	E91D501VNT122MC80U	50 × 80	C80	0.076	5.3
	1,500	E91D501VNT152MCA5U	50 × 105	CA5	0.061	6.7

† For construction and terminal options, refer to the part numbering system for descriptions and codes.

* Refer to diagram of dimensions for detailed case size specifications.

U91D Series

Standard Voltage Ratings - Snap Mount

Rated Voltage (WVDC)	Capacitance (μF)	Global Part Number†	Nominal Case Size* D × L (mm)	Case Size Code	Maximum ESR (Ω) at +25°C, 120Hz	Rated Ripple Current (A rms) at +105°C, 120Hz
550 Volts 600 Volts Surge	220	E91D551VSN221MA50U	35 × 50	A50	0.362	1.8
	330	E91D551VSN331MA65U	35 × 65	A65	0.241	2.4
	470	E91D551VND471MA80U	35 × 80	A80	0.169	3.0
	560	E91D551VND561MAA0U	35 × 100	AA0	0.142	3.7
	330	E91D551VND331MB50U	40 × 50	B50	0.253	2.3
	470	E91D551VND471MB65U	40 × 65	B65	0.178	2.9
	560	E91D551VND561MB80U	40 × 80	B80	0.149	3.4
	820	E91D551VND821MBA0U	40 × 100	BA0	0.102	4.5
	390	E91D551VNT391MU50U	45 × 50	U50	0.225	2.5
	560	E91D551VNT561MU65U	45 × 65	U65	0.156	3.3
	680	E91D551VNT681MU80U	45 × 80	U80	0.129	3.9
	820	E91D551VNT821MUA5U	45 × 105	UA5	0.107	4.8
	470	E91D551VNT471MC50U	50 × 50	C50	0.195	2.8
	680	E91D551VNT681MC65U	50 × 65	C65	0.135	3.7
	820	E91D551VNT821MC80U	50 × 80	C80	0.112	4.4
	1,200	E91D551VNT122MCA5U	50 × 105	CA5	0.076	6.0

† For construction and terminal options, refer to the part numbering system for descriptions and codes.

* Refer to diagram of dimensions for detailed case size specifications.

U92D Series



- Snap Mount
- Specific Design For Higher Ripple Current
- 350 to 550VDC Voltage Range
- RoHS Compliant
- +85°C Maximum Temperature
- 2,000 Hours Lifetime at +85°C



The U92D series is a high temperature snap-in series specifically designed for higher ripple current capability. The U92D capacitors have an endurance rating of 2,000 hours at +85°C with the rated ripple current applied. All the U92D series capacitors are RoHS compliant and offered in a variety of sizes, with or without a PPE end disk, and encased in a standard PVC sleeve or an optional PET sleeve. UL746C compliant exterior insulation material for sleeve and end disk is also available. Snap-in terminals (2, 4 or 5-pin configurations) are available as standard or optional styles depending on case size. Straight standoff terminals (5-pin configuration) are an option for the 40, 45 and 50mm can diameters.

Summary of Specifications

- PC board snap-in or straight standoff terminals available as standard or optional styles depending on pin styles and case size.
- Capacitance range: 270 to 3,300μF.
- Voltage range: 350 to 550VDC.
- Category temperature range: -40°C to +85°C.
- Leakage current: $3\sqrt{CV}$ (μA) or 3mA, whichever is smaller, after 5 minutes at +25°C.
- Standard capacitance tolerance: ±20%
- Nominal case size (D×L): 35×50mm to 50×105mm.
- Rated lifetime: 2,000 hours at +85°C with the rated ripple current applied.

U92D Series

U92D Specifications - Snap Mount

Item	Characteristics																											
Category Temperature Range	- 40 to +85°C																											
Rated Voltage Range	350 to 550VDC																											
Capacitance Range	270 to 3,300 μ F at +25°C, 120Hz																											
Capacitance Tolerance	\pm 20% (M) at +25°C, 120Hz																											
Leakage Current	$I = 3\sqrt{CV}$ (μ A) or 3mA, whichever is smaller, after 5 minutes at +25°C. Where I = Max. leakage current (μ A), C = Nominal capacitance (μ F) and V = Rated voltage (V)																											
Dissipation Factor (Tan δ)	At +25°C, 120Hz <table border="1"> <tr> <td>Rated Voltage (V)</td> <td>350-400</td> <td>450-550</td> </tr> <tr> <td>Tan δ (DF) Max.</td> <td>0.15</td> <td>0.20</td> </tr> </table>	Rated Voltage (V)	350-400	450-550	Tan δ (DF) Max.	0.15	0.20																					
Rated Voltage (V)	350-400	450-550																										
Tan δ (DF) Max.	0.15	0.20																										
Low Temperature Characteristics	At 120Hz, impedance (Z) ratio between the - 40°C value and +25°C value shall not exceed the values given below. <table border="1"> <tr> <td>Rated Voltage (V)</td> <td>350-400</td> <td>450-550</td> </tr> <tr> <td>Z(- 40°C) / Z(+25°C)</td> <td>4</td> <td>8</td> </tr> </table>	Rated Voltage (V)	350-400	450-550	Z(- 40°C) / Z(+25°C)	4	8																					
Rated Voltage (V)	350-400	450-550																										
Z(- 40°C) / Z(+25°C)	4	8																										
Rated Ripple Current Multipliers	Ambient Temperature (°C) <table border="1"> <tr> <td>+45°C</td> <td>+65°C</td> <td>+85°C</td> </tr> <tr> <td>2.82</td> <td>1.73</td> <td>1.00</td> </tr> </table> Frequency (Hz) <table border="1"> <tr> <td>DC Rated Voltage</td> <td>50Hz</td> <td>120Hz</td> <td>300Hz</td> <td>1kHz</td> <td>10kHz</td> <td>100kHz</td> </tr> <tr> <td>350-450V</td> <td>0.77</td> <td>1.00</td> <td>1.16</td> <td>1.30</td> <td>1.41</td> <td>1.43</td> </tr> <tr> <td>500-550V</td> <td>0.70</td> <td>1.00</td> <td>1.16</td> <td>1.30</td> <td>1.41</td> <td>1.43</td> </tr> </table>	+45°C	+65°C	+85°C	2.82	1.73	1.00	DC Rated Voltage	50Hz	120Hz	300Hz	1kHz	10kHz	100kHz	350-450V	0.77	1.00	1.16	1.30	1.41	1.43	500-550V	0.70	1.00	1.16	1.30	1.41	1.43
+45°C	+65°C	+85°C																										
2.82	1.73	1.00																										
DC Rated Voltage	50Hz	120Hz	300Hz	1kHz	10kHz	100kHz																						
350-450V	0.77	1.00	1.16	1.30	1.41	1.43																						
500-550V	0.70	1.00	1.16	1.30	1.41	1.43																						
Endurance (Load Life)	The following specifications shall be satisfied when the capacitors are restored to +25°C after subjecting them to DC voltage for 2,000 hours at +85°C with the rated ripple current applied. The sum of the DC voltage and peak AC voltage must not exceed the full rated voltage of the capacitors. Capacitance change: $\leq \pm 20\%$ of initial measured value Tan δ (DF) : $\leq 200\%$ of initial specified value Leakage current : \leq initial specified value																											
Shelf Life	The following specifications shall be satisfied when the capacitors are restored to +25°C after exposing them for 1,000 hours at +85°C without voltage applied. The rated voltage shall be applied to the capacitors for a minimum of 30 minutes, at least 24 hours and not more than 48 hours before the measurements. Capacitance change: $\leq \pm 20\%$ of initial measured value Tan δ (DF) : $\leq 150\%$ of initial specified value Leakage current : \leq initial specified value																											
Custom Designs	Custom CV values per case size and termination type may be available upon request. Contact appropriate representative with specific requirements.																											

U92D Series

Diagram of Dimensions - Snap Mount

Snap Mount

VSN Snap-in $\varnothing 35$ standard
VNN Snap-in $\varnothing 35$ optional

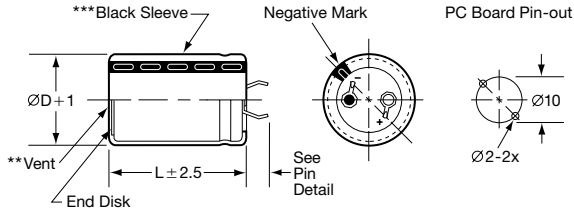

Snap Mount

Unit: mm

VND Snap-in $\varnothing 35$ and $\varnothing 40$ standard; $\varnothing 45$ optional
VSD Snap-in $\varnothing 35$ and $\varnothing 40$ optional

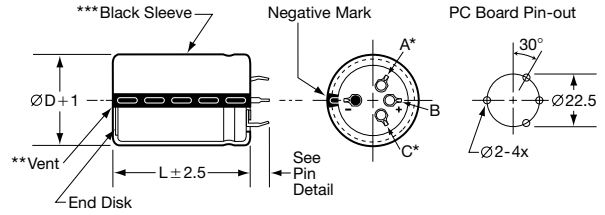

VEN Snap-in $\varnothing 35$ optional

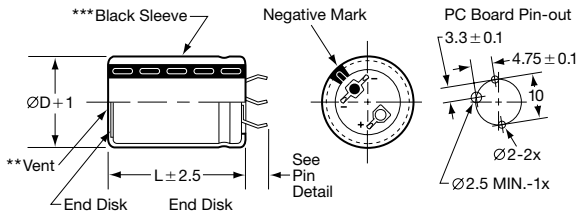

VNT Snap-in $\varnothing 45$ and $\varnothing 50$ standard

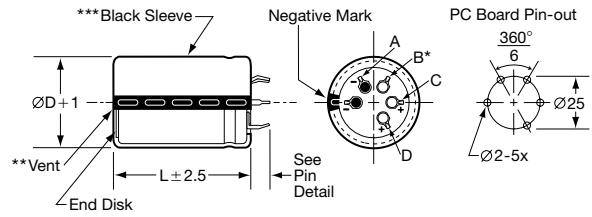

VS, VE & VN Snap-in Pin Dimensions

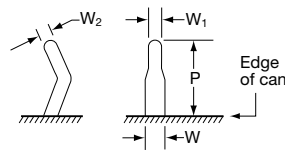

Type	P	W	W ₁	W ₂
VSN $\varnothing 35$	3.5 ± 0.5	1.5 ± 0.2	0.8 ± 0.1	0.8 ± 0.1
VNN $\varnothing 35$	5.8 ± 1.0			
VEN $\varnothing 35$	4.0 ± 0.5			
VSD $\varnothing 35$ - $\varnothing 40$	3.5 ± 1.0			
VND $\varnothing 35$ - $\varnothing 45$	5.8 ± 1.0			
VNT $\varnothing 45$ - $\varnothing 50$	5.8 ± 1.0			

Straight Pin Mount

VQT Straight Standoff $\varnothing 40$, $\varnothing 45$ and $\varnothing 50$ optional

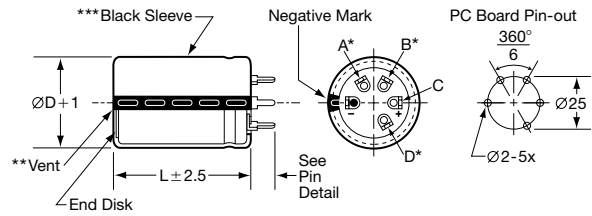

VQ Straight Standoff Pin Dimensions

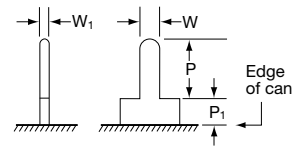

Type	P	P ₁	W	W ₁
Standoff Pin (VQ)	3.75 ± 1.0	2.0 max.	1.5 ± 0.1	0.7 ± 0.2

CAUTION:

*Use the blank terminals for mechanical support only. The blank terminals must not be connected to a solder trace on the PC board but be electrically isolated from the negative and positive terminals.

**The vent may be located either on the bottom or side of the can.

***The black sleeve with gray stripe negative pin indicator is standard. Also note in some cases, the sleeve color may change slightly due to the operating conditions, however, the discoloration will not impair capacitor function.

U92D Series

Part Numbering System for U92D Series When ordering, always specify complete 18-field global part number.

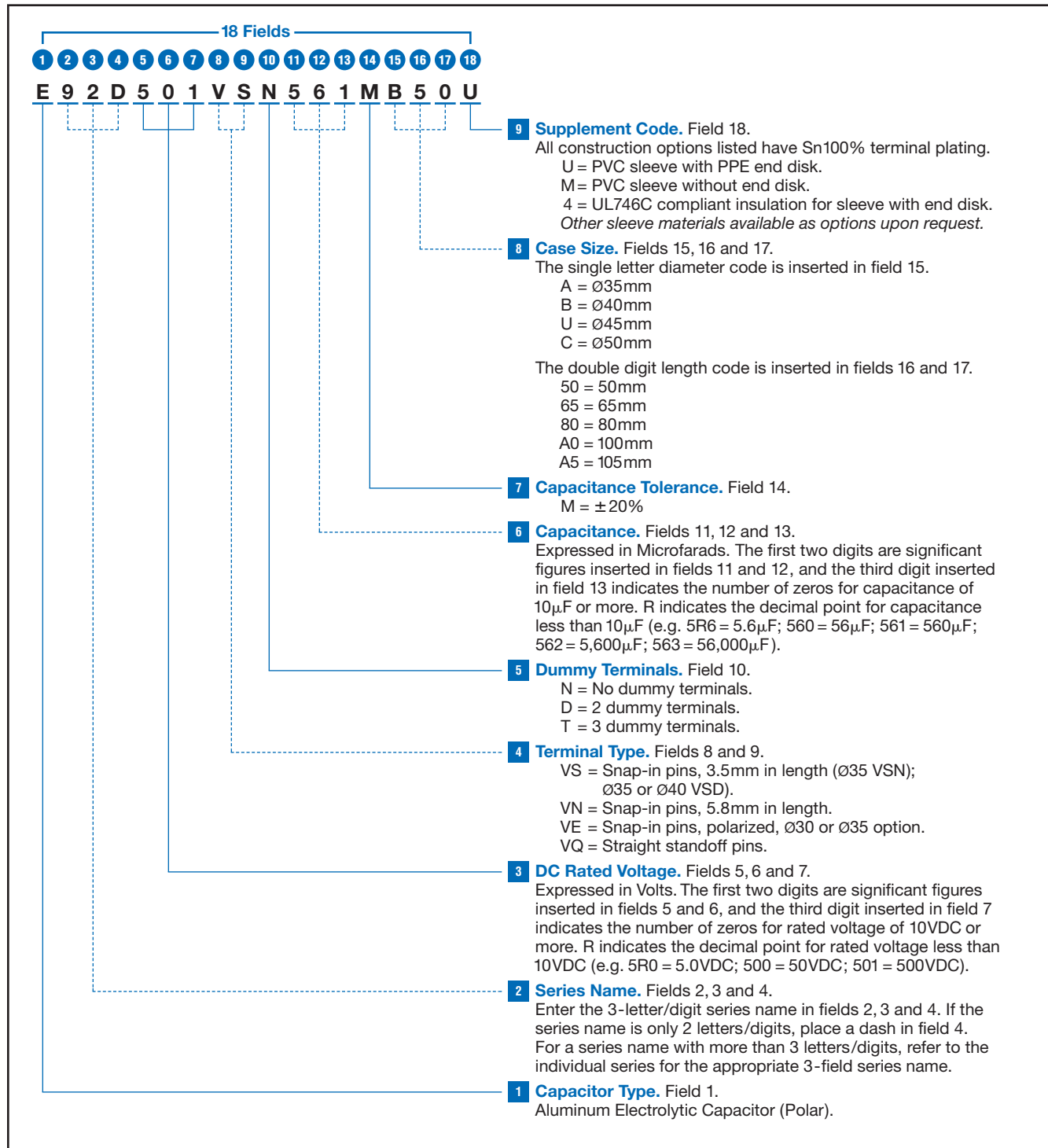

U92D Series

Standard Voltage Ratings - Snap Mount

Rated Voltage (WVDC)	Capacitance (µF)	Global Part Number†	Nominal Case Size* D × L (mm)	Case Size Code	Maximum ESR (Ω) at +25°C, 120Hz	Rated Ripple Current (A rms) at +85°C, 120Hz
350 Volts 400 Volts Surge	1,000	E92D351VSN102MA50U	35 × 50	A50	0.092	5.0
	1,500	E92D351VSN152MA65U	35 × 65	A65	0.061	6.7
	1,800	E92D351VND182MA80U	35 × 80	A80	0.051	7.8
	2,200	E92D351VND222MAA0U	35 × 100	AA0	0.042	9.5
	1,200	E92D351VND122MB50U	40 × 50	B50	0.083	5.6
	1,800	E92D351VND182MB65U	40 × 65	B65	0.055	7.4
	2,200	E92D351VND222MB80U	40 × 80	B80	0.045	8.8
	2,700	E92D351VND272MBA0U	40 × 100	BA0	0.037	10.6
	1,200	E92D351VNT122MU50U	45 × 50	U50	0.090	5.7
	1,800	E92D351VNT182MU65U	45 × 65	U65	0.060	7.6
	2,200	E92D351VNT222MU80U	45 × 80	U80	0.049	9.0
	2,700	E92D351VNT272MUA5U	45 × 105	UA5	0.040	11.1
	1,500	E92D351VNT152MC50U	50 × 50	C50	0.080	6.3
	2,200	E92D351VNT222MC65U	50 × 65	C65	0.054	8.2
	2,700	E92D351VNT272MC80U	50 × 80	C80	0.044	9.9
3,300	E92D351VNT332MCA5U	50 × 105	CA5	0.036	12.4	
400 Volts 450 Volts Surge	820	E92D401VSN821MA50U	35 × 50	A50	0.107	4.7
	1,200	E92D401VSN122MA65U	35 × 65	A65	0.073	6.1
	1,500	E92D401VND152MA80U	35 × 80	A80	0.058	7.3
	1,800	E92D401VND182MAA0U	35 × 100	AA0	0.049	8.8
	1,000	E92D401VND102MB50U	40 × 50	B50	0.092	5.3
	1,500	E92D401VND152MB65U	40 × 65	B65	0.061	7.0
	1,800	E92D401VND182MB80U	40 × 80	B80	0.051	8.3
	2,700	E92D401VND272MBA0U	40 × 100	BA0	0.034	11.1
	1,000	E92D401VNT102MU50U	45 × 50	U50	0.100	5.4
	1,500	E92D401VNT152MU65U	45 × 65	U65	0.066	7.2
	1,800	E92D401VNT182MU80U	45 × 80	U80	0.055	8.5
	2,200	E92D401VNT222MUA5U	45 × 105	UA5	0.045	10.4
	1,200	E92D401VNT122MC50U	50 × 50	C50	0.084	6.1
	1,800	E92D401VNT182MC65U	50 × 65	C65	0.062	7.7
	2,200	E92D401VNT222MC80U	50 × 80	C80	0.051	9.3
2,700	E92D401VNT272MCA5U	50 × 105	CA5	0.041	11.6	
450 Volts 500 Volts Surge	680	E92D451VSN681MA50U	35 × 50	A50	0.123	4.3
	1,000	E92D451VSN102MA65U	35 × 65	A65	0.084	5.7
	1,200	E92D451VND122MA80U	35 × 80	A80	0.070	6.7
	1,500	E92D451VND152MAA0U	35 × 100	AA0	0.056	8.2
	820	E92D451VND821MB50U	40 × 50	B50	0.102	5.0
	1,200	E92D451VND122MB65U	40 × 65	B65	0.070	6.6
	1,500	E92D451VND152MB80U	40 × 80	B80	0.056	7.9
	1,800	E92D451VND182MBA0U	40 × 100	BA0	0.046	9.4
	820	E92D451VNT821MU50U	45 × 50	U50	0.112	5.1
	1,200	E92D451VNT122MU65U	45 × 65	U65	0.076	6.7
	1,500	E92D451VNT152MU80U	45 × 80	U80	0.061	8.1
	1,800	E92D451VNT182MUA5U	45 × 105	UA5	0.051	9.8
	1,200	E92D451VNT122MC50U	50 × 50	C50	0.083	6.1
	1,500	E92D451VNT152MC65U	50 × 65	C65	0.066	7.4
	1,800	E92D451VNT182MC80U	50 × 80	C80	0.055	8.9
2,700	E92D451VNT272MCA5U	50 × 105	CA5	0.037	12.3	
500 Volts 550 Volts Surge	470	E92D501VSN471MA50U	35 × 50	A50	0.169	3.7
	680	E92D501VSN681MA65U	35 × 65	A65	0.117	4.8
	820	E92D501VND821MA80U	35 × 80	A80	0.097	5.6
	1,000	E92D501VND102MAA0U	35 × 100	AA0	0.080	6.9
	560	E92D501VND561MB50U	40 × 50	B50	0.149	4.2
	820	E92D501VND821MB65U	40 × 65	B65	0.102	5.4
	1,000	E92D501VND102MB80U	40 × 80	B80	0.084	6.5
1,200	E92D501VND122MBA0U	40 × 100	BA0	0.070	7.7	

† For construction and terminal options, refer to the part numbering system for descriptions and codes.

* Refer to diagram of dimensions for detailed case size specifications.

U92D Series

Standard Voltage Ratings - Snap Mount

Rated Voltage (WVDC)	Capacitance (μF)	Global Part Number†	Nominal Case Size* D × L (mm)	Case Size Code	Maximum ESR (Ω) at +25°C, 120Hz	Rated Ripple Current (A rms) at +85°C, 120Hz
500 Volts 550 Volts Surge	680	E92D501VNT681MU50U	45 × 50	U50	0.129	4.7
	1,000	E92D501VNT102MU65U	45 × 65	U65	0.088	6.2
	1,200	E92D501VNT122MU80U	45 × 80	U80	0.073	7.4
	1,500	E92D501VNT152MUA5U	45 × 105	UA5	0.058	9.2
	820	E92D501VNT821MC50U	50 × 50	C50	0.112	5.3
	1,200	E92D501VNT122MC65U	50 × 65	C65	0.076	6.9
	1,500	E92D501VNT152MC80U	50 × 80	C80	0.061	8.4
	2,200	E92D501VNT222MCA5U	50 × 105	CA5	0.042	11.5
550 Volts 600 Volts Surge	270	E92D551VSN271MA50U	35 × 50	A50	0.295	2.8
	390	E92D551VSN391MA65U	35 × 65	A65	0.204	3.6
	560	E92D551VND561MA80U	35 × 80	A80	0.142	4.7
	680	E92D551VND681MAA0U	35 × 100	AA0	0.117	5.7
	390	E92D551VND391MB50U	40 × 50	B50	0.214	3.5
	560	E92D551VND561MB65U	40 × 65	B65	0.149	4.5
	680	E92D551VND681MB80U	40 × 80	B80	0.123	5.3
	820	E92D551VND821MBA0U	40 × 100	BA0	0.102	6.4
	470	E92D551VNT471MU50U	45 × 50	U50	0.186	3.9
	560	E92D551VNT561MU65U	45 × 65	U65	0.156	4.7
	680	E92D551VNT681MU80U	45 × 80	U80	0.129	5.6
	1,000	E92D551VNT102MUA5U	45 × 105	UA5	0.088	7.5
	560	E92D551VNT561MC50U	50 × 50	C50	0.164	4.4
	680	E92D551VNT681MC65U	50 × 65	C65	0.135	5.2
	1,000	E92D551VNT102MC80U	50 × 80	C80	0.092	6.9
1,200	E92D551VNT122MCA5U	50 × 105	CA5	0.076	8.5	

† For construction and terminal options, refer to the part numbering system for descriptions and codes.

* Refer to diagram of dimensions for detailed case size specifications.

U93E Series



- **Snap Mount**
- **Specific Design For Higher Ripple Current**
- **350 to 550VDC Voltage Range**
- **RoHS Compliant**
- **+105°C Maximum Temperature**
- **3,000 or 5,000 Hours Lifetime at +105°C**

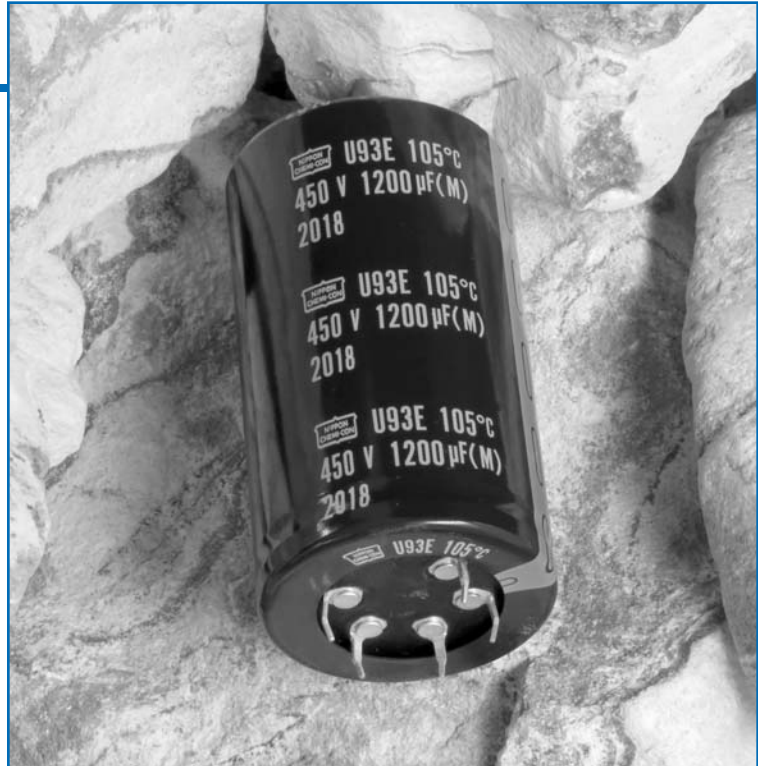

The U93E series is a high temperature snap-in series specifically designed for higher ripple current capability. The U93E capacitors have an endurance rating of 3,000 or 5,000 hours at +105°C with the appropriate rated ripple current applied. All the U93E series capacitors are RoHS compliant and offered in a variety of sizes, with or without a PPE end disk, and encased in a standard PVC sleeve or an optional PET sleeve. UL746C compliant exterior insulation material for sleeve and end disk is also available. Snap-in terminals (2, 4 or 5-pin configurations) are available as standard or optional styles depending on case size. Straight standoff terminals (5-pin configuration) are an option for the 40, 45 and 50mm can diameters.

Summary of Specifications

- **PC board snap-in or straight standoff terminals available as standard or optional styles depending on pin styles and case size.**
- **Capacitance range: 220 to 3,300µF.**
- **Voltage range: 350 to 550VDC.**
- **Category temperature range: -40°C to +105°C.**
- **Leakage current: $3\sqrt{CV}$ (µA) or 3mA, whichever is smaller, after 5 minutes at +25°C.**
- **Standard capacitance tolerance: ±20%**
- **Nominal case size (D×L): 35×50mm to 50×105mm.**
- **Rated lifetime: 3,000 or 5,000 hours at +105°C with the rated ripple current applied.**

U93E Series

U93E Specifications - Snap Mount

Item	Characteristics																											
Category Temperature Range	- 40 to +105°C																											
Rated Voltage Range	350 to 550VDC																											
Capacitance Range	220 to 3,300 μ F at +25°C, 120Hz																											
Capacitance Tolerance	\pm 20% (M) at +25°C, 120Hz																											
Leakage Current	$I = 3\sqrt{CV}$ (μ A) or 3mA, whichever is smaller, after 5 minutes at +25°C. Where I = Max. leakage current (μ A), C = Nominal capacitance (μ F) and V = Rated voltage (V)																											
Dissipation Factor (Tan δ)	At +25°C, 120Hz <table border="1"> <tr> <td>Rated Voltage (V)</td> <td>350-400</td> <td>450-550</td> </tr> <tr> <td>Tan δ (DF) Max.</td> <td>0.15</td> <td>0.20</td> </tr> </table>	Rated Voltage (V)	350-400	450-550	Tan δ (DF) Max.	0.15	0.20																					
Rated Voltage (V)	350-400	450-550																										
Tan δ (DF) Max.	0.15	0.20																										
Low Temperature Characteristics	At 120Hz, impedance (Z) ratio between the - 40°C value and +25°C value shall not exceed the values given below. <table border="1"> <tr> <td>Rated Voltage (V)</td> <td>350-400</td> <td>450-550</td> </tr> <tr> <td>Z(- 40°C) / Z(+25°C)</td> <td>4</td> <td>8</td> </tr> </table>	Rated Voltage (V)	350-400	450-550	Z(- 40°C) / Z(+25°C)	4	8																					
Rated Voltage (V)	350-400	450-550																										
Z(- 40°C) / Z(+25°C)	4	8																										
Rated Ripple Current Multipliers	Ambient Temperature (°C) <table border="1"> <tr> <td>+65°C</td> <td>+85°C</td> <td>+105°C</td> </tr> <tr> <td>2.82</td> <td>1.73</td> <td>1.00</td> </tr> </table> Frequency (Hz) <table border="1"> <tr> <td>DC Rated Voltage</td> <td>50Hz</td> <td>120Hz</td> <td>300Hz</td> <td>1kHz</td> <td>10kHz</td> <td>100kHz</td> </tr> <tr> <td>350-450V</td> <td>0.77</td> <td>1.00</td> <td>1.16</td> <td>1.30</td> <td>1.41</td> <td>1.43</td> </tr> <tr> <td>500-550V</td> <td>0.70</td> <td>1.00</td> <td>1.16</td> <td>1.30</td> <td>1.41</td> <td>1.43</td> </tr> </table>	+65°C	+85°C	+105°C	2.82	1.73	1.00	DC Rated Voltage	50Hz	120Hz	300Hz	1kHz	10kHz	100kHz	350-450V	0.77	1.00	1.16	1.30	1.41	1.43	500-550V	0.70	1.00	1.16	1.30	1.41	1.43
+65°C	+85°C	+105°C																										
2.82	1.73	1.00																										
DC Rated Voltage	50Hz	120Hz	300Hz	1kHz	10kHz	100kHz																						
350-450V	0.77	1.00	1.16	1.30	1.41	1.43																						
500-550V	0.70	1.00	1.16	1.30	1.41	1.43																						
Endurance (Load Life)	The following specifications shall be satisfied when the capacitors are restored to +25°C after subjecting them to DC voltage for 3,000 or 5,000 hours at +105°C with the appropriate rated ripple current applied. The sum of the DC voltage and peak AC voltage must not exceed the full rated voltage of the capacitors. Capacitance change: $\leq \pm 20\%$ of initial measured value Tan δ (DF) : $\leq 200\%$ of initial specified value Leakage current : \leq initial specified value																											
Shelf Life	The following specifications shall be satisfied when the capacitors are restored to +25°C after exposing them for 1,000 hours at +105°C without voltage applied. The rated voltage shall be applied to the capacitors for a minimum of 30 minutes, at least 24 hours and not more than 48 hours before the measurements. Capacitance change: $\leq \pm 20\%$ of initial measured value Tan δ (DF) : $\leq 150\%$ of initial specified value Leakage current : \leq initial specified value																											
Custom Designs	Custom CV values per case size and termination type may be available upon request. Contact appropriate representative with specific requirements.																											

U93E Series

Diagram of Dimensions - Snap Mount

Snap Mount

VSN Snap-in $\varnothing 35$ standard
VNN Snap-in $\varnothing 35$ optional

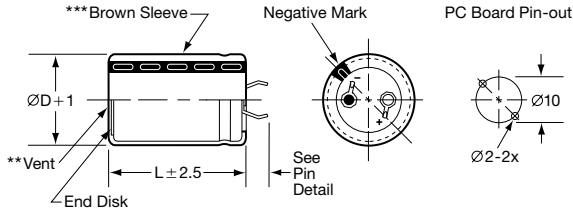

Snap Mount

Unit: mm

VND Snap-in $\varnothing 35$ and $\varnothing 40$ standard; $\varnothing 45$ optional
VSD Snap-in $\varnothing 35$ and $\varnothing 40$ optional

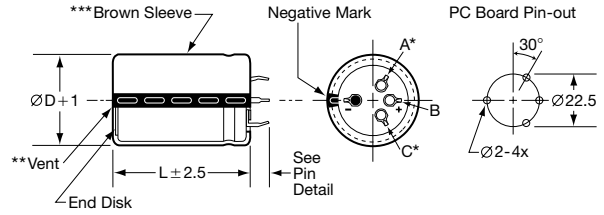

VEN Snap-in $\varnothing 35$ optional

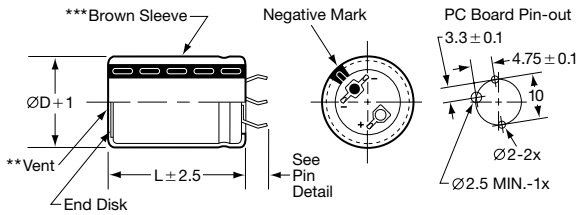

VNT Snap-in $\varnothing 45$ and $\varnothing 50$ standard

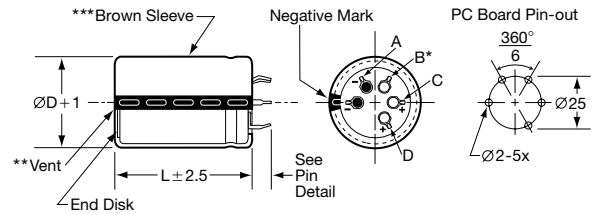

VS, VE & VN Snap-in Pin Dimensions

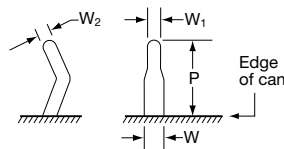

Type	P	W	W ₁	W ₂
VSN $\varnothing 35$	3.5 ± 0.5	1.5 ± 0.2	0.8 ± 0.1	0.8 ± 0.1
VNN $\varnothing 35$	5.8 ± 1.0			
VEN $\varnothing 35$	4.0 ± 0.5			
VSD $\varnothing 35$ - $\varnothing 40$	3.5 ± 1.0			
VND $\varnothing 35$ - $\varnothing 45$	5.8 ± 1.0			
VNT $\varnothing 45$ - $\varnothing 50$	5.8 ± 1.0			

Straight Pin Mount

VQT Straight Standoff $\varnothing 40$, $\varnothing 45$ and $\varnothing 50$ optional

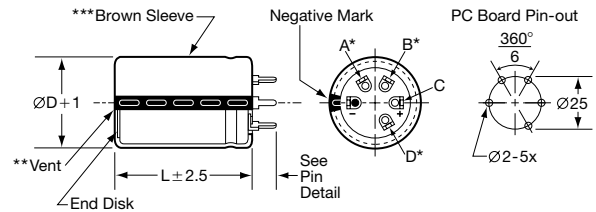

VQ Straight Standoff Pin Dimensions

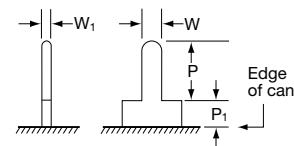

Type	P	P ₁	W	W ₁
Standoff Pin (VQ)	3.75 ± 1.0	2.0 max.	1.5 ± 0.1	0.7 ± 0.2

CAUTION:

*Use the blank terminals for mechanical support only. The blank terminals must not be connected to a solder trace on the PC board but be electrically isolated from the negative and positive terminals.

**The vent may be located either on the bottom or side of the can.

***The brown sleeve with gray stripe negative pin indicator is standard. Also note in some cases, the sleeve color may change slightly due to the operating conditions, however, the discoloration will not impair capacitor function.

U93E Series

Part Numbering System for U93E Series When ordering, always specify complete 18-field global part number.

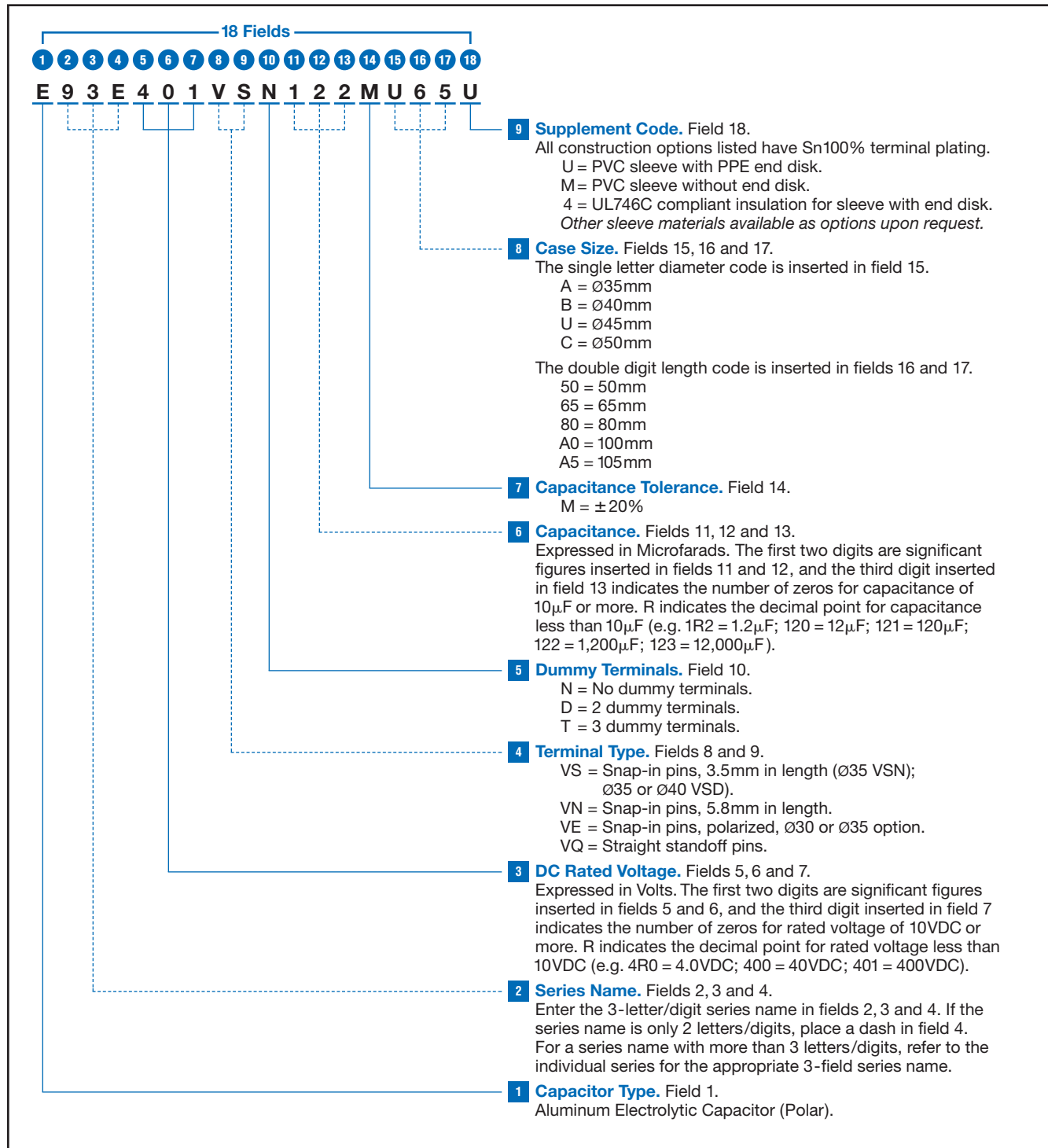

U93E Series

Standard Voltage Ratings - Snap Mount

Rated Voltage (WVDC)	Capacitance (µF)	Global Part Number†	Nominal Case Size* D × L (mm)	Case Size Code	Maximum ESR (Ω) at +25°C, 120Hz	Rated Ripple Current (A rms) at +105°C, 120Hz	
						3k Hours	5k Hours
350 Volts 400 Volts Surge	680	E93E351VSN681MA50U	35 × 50	A50	0.135	2.9	1.5
	1,000	E93E351VSN102MA65U	35 × 65	A65	0.092	3.8	1.9
	1,200	E93E351VND122MA80U	35 × 80	A80	0.076	4.5	2.3
	1,800	E93E351VND182MAA0U	35 × 100	AA0	0.051	6.1	3.1
	820	E93E351VND821MB50U	40 × 50	B50	0.121	3.3	1.6
	1,200	E93E351VND122MB65U	40 × 65	B65	0.083	4.3	2.1
	1,500	E93E351VND152MB80U	40 × 80	B80	0.066	5.1	2.6
	1,800	E93E351VND182MBA0U	40 × 100	BA0	0.055	6.1	3.1
	1,000	E93E351VNT102MU50U	45 × 50	U50	0.107	3.7	1.8
	1,500	E93E351VNT152MU65U	45 × 65	U65	0.072	4.9	2.4
	1,800	E93E351VNT182MU80U	45 × 80	U80	0.060	5.8	2.9
	2,200	E93E351VNT222MUA5U	45 × 105	UA5	0.049	7.1	3.6
	1,200	E93E351VNT122MC50U	50 × 50	C50	0.092	4.1	2.1
	1,800	E93E351VNT182MC65U	50 × 65	C65	0.066	5.2	2.6
	2,200	E93E351VNT222MC80U	50 × 80	C80	0.054	6.3	3.2
3,300	E93E351VNT332MCA5U	50 × 105	CA5	0.036	8.7	4.4	
400 Volts 450 Volts Surge	560	E93E401VSN561MA50U	35 × 50	A50	0.156	2.7	1.4
	820	E93E401VSN821MA65U	35 × 65	A65	0.107	3.6	1.8
	1,000	E93E401VND102MA80U	35 × 80	A80	0.088	4.2	2.1
	1,500	E93E401VND152MAA0U	35 × 100	AA0	0.058	5.7	2.8
	680	E93E401VND681MB50U	40 × 50	B50	0.135	3.1	1.5
	1,000	E93E401VND102MB65U	40 × 65	B65	0.092	4.1	2.0
	1,200	E93E401VND122MB80U	40 × 80	B80	0.076	4.8	2.4
	1,800	E93E401VND182MBA0U	40 × 100	BA0	0.051	6.4	3.2
	820	E93E401VNT821MU50U	45 × 50	U50	0.121	3.5	1.7
	1,200	E93E401VNT122MU65U	45 × 65	U65	0.083	4.5	2.3
	1,500	E93E401VNT152MU80U	45 × 80	U80	0.066	5.5	2.7
	2,200	E93E401VNT222MUA5U	45 × 105	UA5	0.045	7.4	3.7
	1,000	E93E401VNT102MC50U	50 × 50	C50	0.101	3.9	2.0
	1,500	E93E401VNT152MC65U	50 × 65	C65	0.074	5.0	2.5
	2,000	E93E401VNT202MC80U	50 × 80	C80	0.056	6.3	3.1
2,700	E93E401VNT272MCA5U	50 × 105	CA5	0.041	8.2	4.1	
450 Volts 500 Volts Surge	470	E93E451VSN471MA50U	35 × 50	A50	0.178	2.6	1.3
	680	E93E451VSN681MA65U	35 × 65	A65	0.123	3.3	1.7
	1,000	E93E451VND102MA80U	35 × 80	A80	0.084	4.3	2.2
	1,200	E93E451VND122MAA0U	35 × 100	AA0	0.070	5.2	2.6
	560	E93E451VND561MB50U	40 × 50	B50	0.164	2.8	1.4
	820	E93E451VND821MB65U	40 × 65	B65	0.112	3.7	1.8
	1,000	E93E451VND102MB80U	40 × 80	B80	0.092	4.4	2.2
	1,200	E93E451VND122MBA0U	40 × 100	BA0	0.076	5.2	2.6
	680	E93E451VNT681MU50U	45 × 50	U50	0.135	3.3	1.6
	1,000	E93E451VNT102MU65U	45 × 65	U65	0.092	4.3	2.2
	1,200	E93E451VNT122MU80U	45 × 80	U80	0.076	5.1	2.6
	1,800	E93E451VNT182MUA5U	45 × 105	UA5	0.051	7.0	3.5
	820	E93E451VNT821MC50U	50 × 50	C50	0.121	3.6	1.8
	1,200	E93E451VNT122MC65U	50 × 65	C65	0.083	4.7	2.3
	1,500	E93E451VNT152MC80U	50 × 80	C80	0.066	5.7	2.9
2,200	E93E451VNT222MCA5U	50 × 105	CA5	0.045	7.8	3.9	
500 Volts 550 Volts Surge	330	E93E501VSN331MA50U	35 × 50	A50	0.241	2.2	1.1
	470	E93E501VSN471MA65U	35 × 65	A65	0.169	2.8	1.4
	560	E93E501VND561MA80U	35 × 80	A80	0.142	3.3	1.6
	820	E93E501VND821MAA0U	35 × 100	AA0	0.097	4.4	2.2
	390	E93E501VND391MB50U	40 × 50	B50	0.214	2.5	1.2
	560	E93E501VND561MB65U	40 × 65	B65	0.149	3.2	1.6
	820	E93E501VND821MB80U	40 × 80	B80	0.102	4.1	2.1
	1,000	E93E501VND102MBA0U	40 × 100	BA0	0.084	5.0	2.5

† For construction and terminal options, refer to the part numbering system for descriptions and codes.

* Refer to diagram of dimensions for detailed case size specifications.

U93E Series

Standard Voltage Ratings - Snap Mount

Rated Voltage (WVDC)	Capacitance (μF)	Global Part Number†	Nominal Case Size* D × L (mm)	Case Size Code	Maximum ESR (Ω) at +25°C, 120Hz	Rated Ripple Current (A rms) at +105°C, 120Hz	
						3k Hours	5k Hours
500 Volts 550 Volts Surge	560	E93E501VNT561MU50U	45 × 50	U50	0.156	3.0	1.5
	820	E93E501VNT821MU65U	45 × 65	U65	0.107	4.0	2.0
	1,000	E93E501VNT102MU80U	45 × 80	U80	0.088	4.8	2.4
	1,200	E93E501VNT122MUA5U	45 × 105	UA5	0.073	5.8	2.9
	680	E93E501VNT681MC50U	50 × 50	C50	0.135	3.4	1.7
	1,000	E93E501VNT102MC65U	50 × 65	C65	0.092	4.5	2.2
	1,200	E93E501VNT122MC80U	50 × 80	C80	0.076	5.3	2.7
	1,500	E93E501VNT152MCA5U	50 × 105	CA5	0.061	6.7	3.4
550 Volts 600 Volts Surge	220	E93E501VSN221MA50U	35 × 50	A50	0.398	1.7	0.9
	330	E93E501VSN331MA65U	35 × 65	A65	0.265	2.3	1.1
	390	E93E501VND391MA80U	35 × 80	A80	0.225	2.6	1.3
	560	E93E501VND561MAA0U	35 × 100	AA0	0.156	3.5	1.7
	220	E93E501VND221MB50U	40 × 50	B50	0.416	1.8	0.9
	390	E93E501VND391MB65U	40 × 65	B65	0.235	2.5	1.3
	560	E93E501VND561MB80U	40 × 80	B80	0.164	3.3	1.6
	680	E93E501VND681MBA0U	40 × 100	BA0	0.135	3.9	2.0
	390	E93E501VNT391MU50U	45 × 50	U50	0.245	2.4	1.2
	470	E93E501VNT471MU65U	45 × 65	U65	0.203	2.9	1.4
	560	E93E501VNT561MU80U	45 × 80	U80	0.171	3.4	1.7
	820	E93E501VNT821MUA5U	45 × 105	UA5	0.117	4.6	2.3
	470	E93E501VNT471MC50U	50 × 50	C50	0.212	2.7	1.4
	560	E93E501VNT561MC65U	50 × 65	C65	0.178	3.2	1.6
	820	E93E501VNT821MC80U	50 × 80	C80	0.121	4.2	2.1
	1,000	E93E501VNT102MCA5U	50 × 105	CA5	0.100	5.3	2.6

† For construction and terminal options, refer to the part numbering system for descriptions and codes.

* Refer to diagram of dimensions for detailed case size specifications.

U91F Series



- Snap Mount
- Specific Design For Higher Ripple Current
- 350 to 500VDC Voltage Range
- RoHS Compliant
- +105°C Maximum Temperature
- 5,000 Hours Lifetime at +105°C

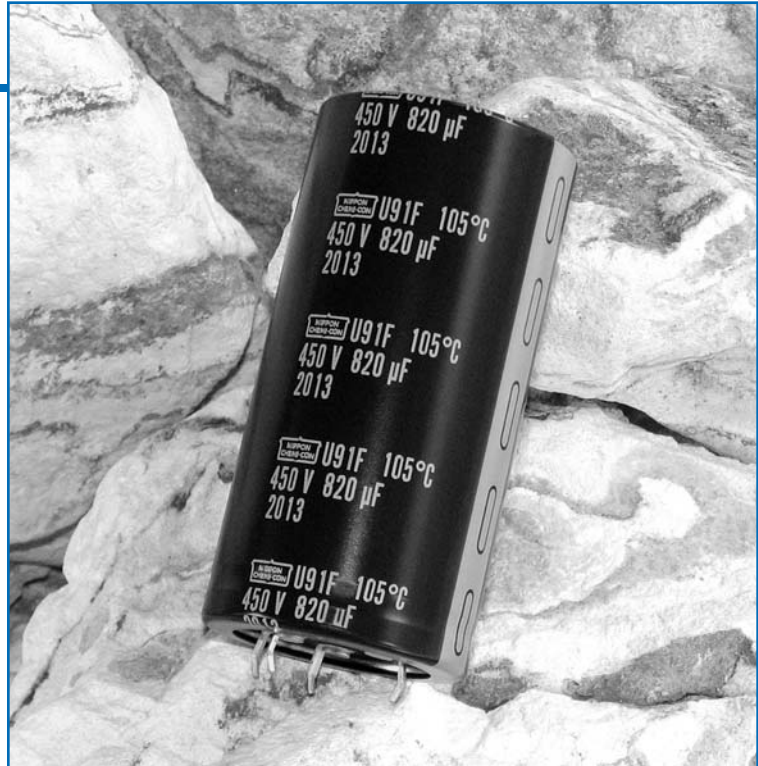

The U91F series is a high temperature snap-in series specifically designed for higher ripple current capability. The U91F capacitors have an endurance rating of 5,000 hours at +105°C with the rated ripple current applied. All the U91F series capacitors are RoHS compliant and offered in a variety of sizes, with or without a PPE end disk, and encased in a standard PVC sleeve or an optional PET sleeve. UL746C compliant exterior insulation material for sleeve and end disk is also available. Snap-in terminals (2, 4 or 5-pin configurations) are available as standard or optional styles depending on case size. Straight standoff terminals (5-pin configuration) are an option for the 40, 45 and 50mm can diameters.

Summary of Specifications

- PC board snap-in or straight standoff terminals available as standard or optional styles depending on pin styles and case size.
- Capacitance range: 120 to 2,700µF.
- Voltage range: 350 to 500VDC.
- Category temperature range: -40°C to +105°C.
- Leakage current: $3\sqrt{CV}$ (µA) or 3mA, whichever is smaller, after 5 minutes at +25°C.
- Standard capacitance tolerance: ±20%
- Nominal case size (D×L): 30×40mm to 50×105mm.
- Rated lifetime: 5,000 hours at +105°C with the rated ripple current applied.

U91F Series

U91F Specifications - Snap Mount

Item	Characteristics																											
Category Temperature Range	- 40 to +105°C																											
Rated Voltage Range	350 to 500VDC																											
Capacitance Range	120 to 2,700 μ F at +25°C, 120Hz																											
Capacitance Tolerance	\pm 20% (M) at +25°C, 120Hz																											
Leakage Current	$I = 3\sqrt{CV}$ (μ A) or 3mA, whichever is smaller, after 5 minutes at +25°C. Where I = Max. leakage current (μ A), C = Nominal capacitance (μ F) and V = Rated voltage (V)																											
Dissipation Factor (Tan δ)	At +25°C, 120Hz <table border="1"> <tr> <td>Rated Voltage (V)</td> <td>350-400</td> <td>420-500</td> </tr> <tr> <td>Tan δ (DF) Max.</td> <td>0.15</td> <td>0.20</td> </tr> </table>	Rated Voltage (V)	350-400	420-500	Tan δ (DF) Max.	0.15	0.20																					
Rated Voltage (V)	350-400	420-500																										
Tan δ (DF) Max.	0.15	0.20																										
Low Temperature Characteristics	At 120Hz, impedance (Z) ratio between the - 40°C value and +25°C value shall not exceed the values given below. <table border="1"> <tr> <td>Rated Voltage (V)</td> <td>350-400</td> <td>420-500</td> </tr> <tr> <td>Z(- 40°C) / Z(+25°C)</td> <td>4</td> <td>8</td> </tr> </table>	Rated Voltage (V)	350-400	420-500	Z(- 40°C) / Z(+25°C)	4	8																					
Rated Voltage (V)	350-400	420-500																										
Z(- 40°C) / Z(+25°C)	4	8																										
Rated Ripple Current Multipliers	Ambient Temperature (°C) <table border="1"> <tr> <td>+65°C</td> <td>+85°C</td> <td>+105°C</td> </tr> <tr> <td>2.82</td> <td>1.73</td> <td>1.00</td> </tr> </table> Frequency (Hz) <table border="1"> <tr> <td>DC Rated Voltage</td> <td>50Hz</td> <td>120Hz</td> <td>300Hz</td> <td>1kHz</td> <td>10kHz</td> <td>100kHz</td> </tr> <tr> <td>350-450V</td> <td>0.77</td> <td>1.00</td> <td>1.16</td> <td>1.30</td> <td>1.41</td> <td>1.43</td> </tr> <tr> <td>500V</td> <td>0.70</td> <td>1.00</td> <td>1.16</td> <td>1.30</td> <td>1.41</td> <td>1.43</td> </tr> </table>	+65°C	+85°C	+105°C	2.82	1.73	1.00	DC Rated Voltage	50Hz	120Hz	300Hz	1kHz	10kHz	100kHz	350-450V	0.77	1.00	1.16	1.30	1.41	1.43	500V	0.70	1.00	1.16	1.30	1.41	1.43
+65°C	+85°C	+105°C																										
2.82	1.73	1.00																										
DC Rated Voltage	50Hz	120Hz	300Hz	1kHz	10kHz	100kHz																						
350-450V	0.77	1.00	1.16	1.30	1.41	1.43																						
500V	0.70	1.00	1.16	1.30	1.41	1.43																						
Endurance (Load Life)	The following specifications shall be satisfied when the capacitors are restored to +25°C after subjecting them to DC voltage for 5,000 hours at +105°C with the rated ripple current applied. The sum of the DC voltage and peak AC voltage must not exceed the full rated voltage of the capacitors. Capacitance change: $\leq \pm 20\%$ of initial measured value Tan δ (DF) : $\leq 200\%$ of initial specified value Leakage current : \leq initial specified value																											
Shelf Life	The following specifications shall be satisfied when the capacitors are restored to +25°C after exposing them for 1,000 hours at +105°C without voltage applied. The rated voltage shall be applied to the capacitors for a minimum of 30 minutes, at least 24 hours and not more than 48 hours before the measurements. Capacitance change: $\leq \pm 20\%$ of initial measured value Tan δ (DF) : $\leq 150\%$ of initial specified value Leakage current : \leq initial specified value																											
Custom Designs	Custom CV values per case size and termination type may be available upon request. Contact appropriate representative with specific requirements.																											

U91F Series

Diagram of Dimensions - Snap Mount

Snap Mount

VSN Snap-in $\varnothing 30$ and $\varnothing 35$ standard
VNN Snap-in $\varnothing 30$ and $\varnothing 35$ optional

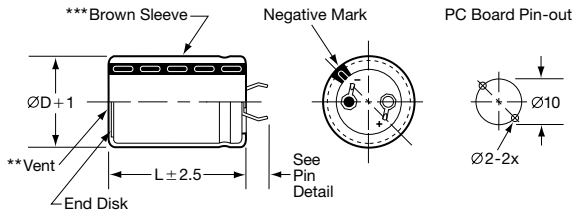

Snap Mount

Unit: mm

VND Snap-in $\varnothing 35$ and $\varnothing 40$ standard; $\varnothing 45$ optional
VSD Snap-in $\varnothing 35$ and $\varnothing 40$ optional

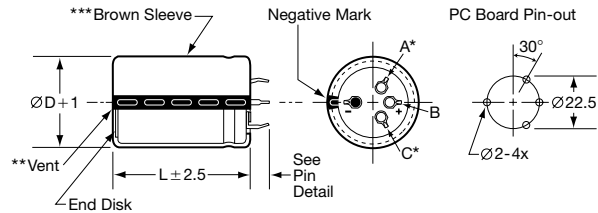

VEN Snap-in $\varnothing 30$ and $\varnothing 35$ optional

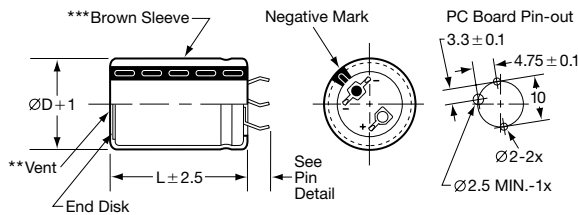

VNT Snap-in $\varnothing 45$ and $\varnothing 50$ standard

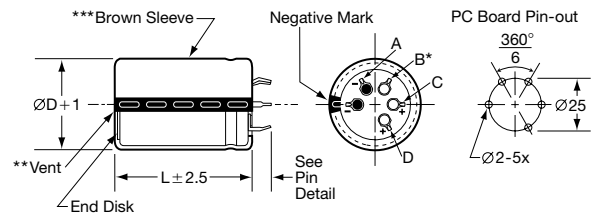

VS, VE & VN Snap-in Pin Dimensions

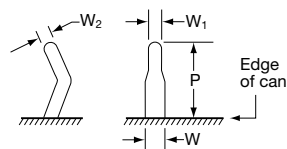

Type	P	W	W ₁	W ₂
VSN $\varnothing 30$	4.0 ± 0.5	1.5 ± 0.2	0.8 ± 0.1	0.8 ± 0.1
VSN $\varnothing 35$	3.5 ± 0.5			
VNN $\varnothing 30$ - $\varnothing 35$	5.8 ± 1.0			
VEN $\varnothing 30$ - $\varnothing 35$	4.0 ± 0.5			
VSD $\varnothing 35$ - $\varnothing 40$	3.5 ± 1.0			
VND $\varnothing 35$ - $\varnothing 45$	5.8 ± 1.0			
VNT $\varnothing 45$ - $\varnothing 50$	5.8 ± 1.0			

Straight Pin Mount

VQT Straight Standoff $\varnothing 40$, $\varnothing 45$ and $\varnothing 50$ optional

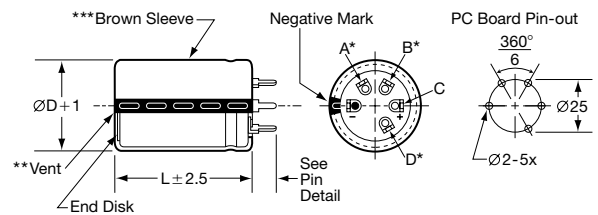

VQ Straight Standoff Pin Dimensions

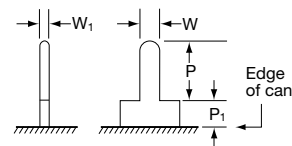

Type	P	P ₁	W	W ₁
Standoff Pin (VQ)	3.75 ± 1.0	2.0 max.	1.5 ± 0.1	0.7 ± 0.2

CAUTION:

* Use the blank terminals for mechanical support only. The blank terminals must not be connected to a solder trace on the PC board but be electrically isolated from the negative and positive terminals.

** The vent may be located either on the bottom or side of the can.

*** The brown sleeve with gray stripe negative pin indicator is standard. Also note in some cases, the sleeve color may change slightly due to the operating conditions, however, the discoloration will not impair capacitor function.

U91F Series

Part Numbering System for U91F Series When ordering, always specify complete 18-field global part number.

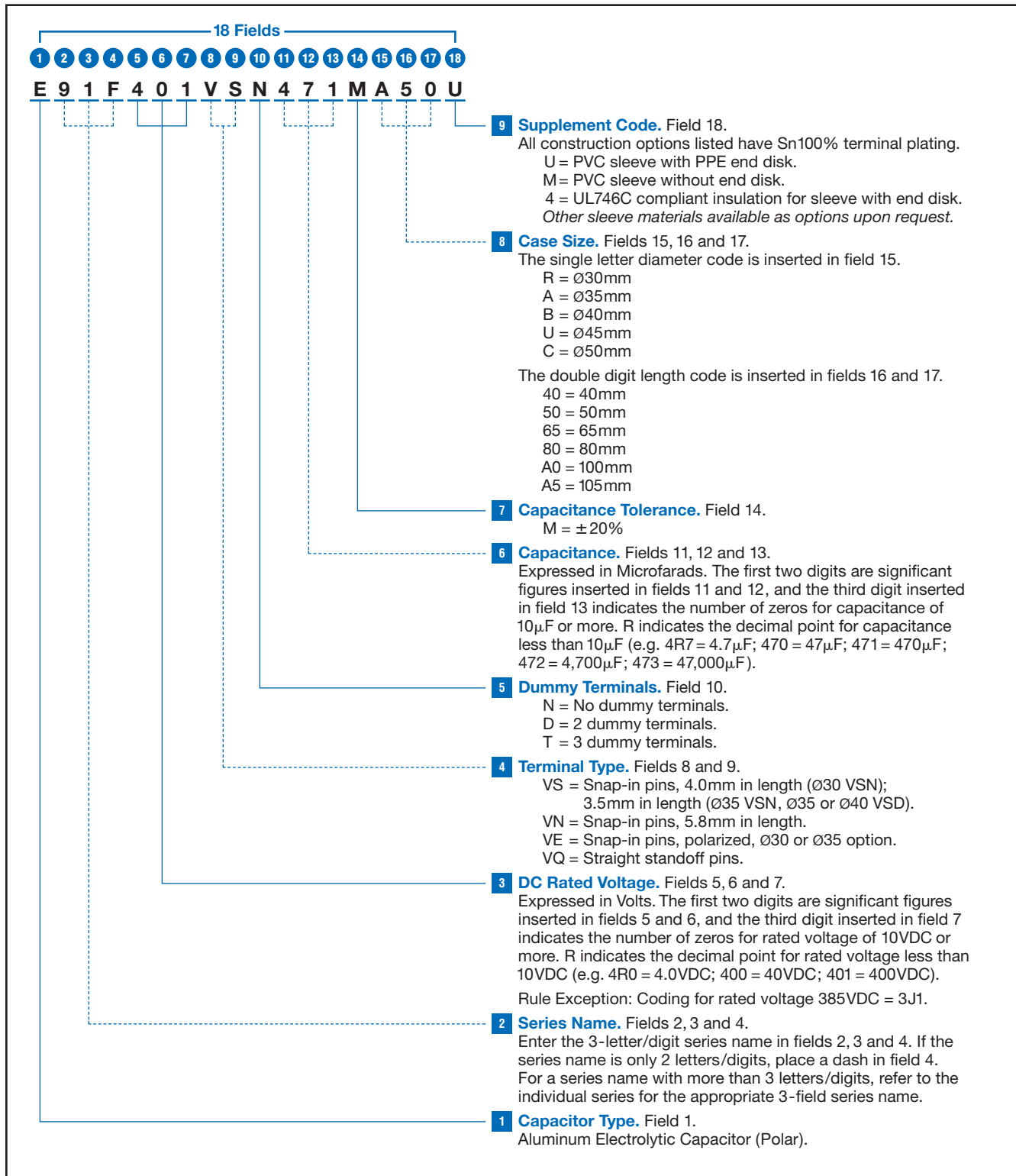

U91F Series

Standard Voltage Ratings - Snap Mount

Rated Voltage (WVDC)	Capacitance (μF)	Global Part Number†	Nominal Case Size* D × L (mm)	Case Size Code	Maximum ESR (Ω) at +25°C, 120Hz	Rated Ripple Current (A rms) at +105°C, 120Hz
350 Volts 400 Volts Surge	270	E91F351VSN271MR40U	30 × 40	R40	0.324	1.5
	390	E91F351VSN391MR50U	30 × 50	R50	0.225	2.0
	560	E91F351VSN561MR65U	30 × 65	R65	0.156	2.6
	390	E91F351VSN391MA40U	35 × 40	A40	0.235	2.0
	560	E91F351VSN561MA50U	35 × 50	A50	0.164	2.7
	820	E91F351VSN821MA65U	35 × 65	A65	0.112	3.5
	1,000	E91F351VND102MA80U	35 × 80	A80	0.092	4.1
	1,200	E91F351VND122MAA0U	35 × 100	AA0	0.076	5.0
	820	E91F351VND821MB50U	40 × 50	B50	0.121	3.3
	1,200	E91F351VND122MB65U	40 × 65	B65	0.083	4.3
	1,500	E91F351VND152MB80U	40 × 80	B80	0.066	5.1
	1,800	E91F351VND182MBA0U	40 × 100	BA0	0.055	6.1
	820	E91F351VNT821MU50U	45 × 50	U50	0.131	3.3
	1,200	E91F351VNT122MU65U	45 × 65	U65	0.090	4.4
	1,800	E91F351VNT182MU80U	45 × 80	U80	0.060	5.8
	2,200	E91F351VNT222MUA5U	45 × 105	UA5	0.049	7.1
	1,200	E91F351VNT122MC50U	50 × 50	C50	0.092	4.1
	1,800	E91F351VNT182MC65U	50 × 65	C65	0.066	5.2
2,200	E91F351VNT222MC80U	50 × 80	C80	0.054	6.3	
2,700	E91F351VNT272MCA5U	50 × 105	CA5	0.044	7.9	
385 Volts 435 Volts Surge	220	E91F3J1VSN221MR40U	30 × 40	R40	0.336	1.5
	330	E91F3J1VSN331MR50U	30 × 50	R50	0.245	1.9
	470	E91F3J1VSN471MR65U	30 × 65	R65	0.174	2.5
	330	E91F3J1VSN331MA40U	35 × 40	A40	0.237	2.0
	470	E91F3J1VSN471MA50U	35 × 50	A50	0.173	2.6
	680	E91F3J1VSN681MA65U	35 × 65	A65	0.123	3.3
	1,000	E91F3J1VND102MA80U	35 × 80	A80	0.095	4.0
	1,200	E91F3J1VND122MAA0U	35 × 100	AA0	0.073	5.1
	680	E91F3J1VND681MB50U	40 × 50	B50	0.135	3.1
	1,000	E91F3J1VND102MB65U	40 × 65	B65	0.096	4.0
	1,200	E91F3J1VND122MB80U	40 × 80	B80	0.075	4.8
	1,500	E91F3J1VND152MBA0U	40 × 100	BA0	0.058	6.0
	820	E91F3J1VNT821MU50U	45 × 50	U50	0.118	3.5
	1,200	E91F3J1VNT122MU65U	45 × 65	U65	0.084	4.5
	1,500	E91F3J1VNT152MU80U	45 × 80	U80	0.065	5.5
	1,800	E91F3J1VNT182MUA5U	45 × 105	UA5	0.047	7.2
	1,000	E91F3J1VNT102MC50U	50 × 50	C50	0.094	4.1
	1,500	E91F3J1VNT152MC65U	50 × 65	C65	0.073	5.0
1,800	E91F3J1VNT182MC80U	50 × 80	C80	0.056	6.2	
2,700	E91F3J1VNT272MCA5U	50 × 105	CA5	0.041	8.2	
400 Volts 450 Volts Surge	220	E91F401VSN221MR40U	30 × 40	R40	0.380	1.4
	330	E91F401VSN331MR50U	30 × 50	R50	0.253	1.8
	390	E91F401VSN391MR65U	30 × 65	R65	0.214	2.2
	330	E91F401VSN331MA40U	35 × 40	A40	0.265	1.9
	470	E91F401VSN471MA50U	35 × 50	A50	0.186	2.5
	680	E91F401VSN681MA65U	35 × 65	A65	0.129	3.2
	820	E91F401VND821MA80U	35 × 80	A80	0.107	3.8
	1,000	E91F401VND102MAA0U	35 × 100	AA0	0.088	4.7
	560	E91F401VND561MB50U	40 × 50	B50	0.164	2.8
	820	E91F401VND821MB65U	40 × 65	B65	0.112	3.7
	1,200	E91F401VND122MB80U	40 × 80	B80	0.076	4.8
	1,500	E91F401VND152MBA0U	40 × 100	BA0	0.061	5.8
	680	E91F401VNT681MU50U	45 × 50	U50	0.146	3.1
	1,000	E91F401VNT102MU65U	45 × 65	U65	0.100	4.1

†For construction and terminal options, refer to the part numbering system for descriptions and codes.

*Refer to diagram of dimensions for detailed case size specifications.

U91F Series

Standard Voltage Ratings - Snap Mount

Rated Voltage (WVDC)	Capacitance (µF)	Global Part Number†	Nominal Case Size* D × L (mm)	Case Size Code	Maximum ESR (Ω) at +25°C, 120Hz	Rated Ripple Current (A rms) at +105°C, 120Hz
400 Volts 450 Volts Surge	1,200	E91F401VNT122MU80U	45 × 80	U80	0.083	4.9
	1,800	E91F401VNT182MUA5U	45 × 105	UA5	0.055	6.7
	1,000	E91F401VNT102MC50U	50 × 50	C50	0.101	3.9
	1,200	E91F401VNT122MC65U	50 × 65	C65	0.093	4.4
	1,800	E91F401VNT182MC80U	50 × 80	C80	0.062	5.9
	2,200	E91F401VNT222MCA5U	50 × 105	CA5	0.051	7.4
420 Volts 470 Volts Surge	180	E91F421VSN181MR40U	30 × 40	R40	0.442	1.3
	270	E91F421VSN271MR50U	30 × 50	R50	0.295	1.7
	390	E91F421VSN391MR65U	30 × 65	R65	0.204	2.3
	270	E91F421VSN271MA40U	35 × 40	A40	0.310	1.8
	390	E91F421VSN391MA50U	35 × 50	A50	0.214	2.3
	560	E91F421VSN561MA65U	35 × 65	A65	0.149	3.0
	680	E91F421VND681MA80U	35 × 80	A80	0.123	3.5
	820	E91F421VND821MAA0U	35 × 100	AA0	0.102	4.3
	560	E91F421VND561MB50U	40 × 50	B50	0.156	2.9
	820	E91F421VND821MB65U	40 × 65	B65	0.107	3.8
	1,000	E91F421VND102MB80U	40 × 80	B80	0.088	4.5
	1,200	E91F421VND122MBA0U	40 × 100	BA0	0.073	5.3
	680	E91F421VNT681MU50U	45 × 50	U50	0.141	3.2
	1,000	E91F421VNT102MU65U	45 × 65	U65	0.096	4.2
	1,200	E91F421VNT122MU80U	45 × 80	U80	0.080	5.0
	1,700	E91F421VNT172MUA5U	45 × 105	UA5	0.056	6.6
	820	E91F421VNT821MC50U	50 × 50	C50	0.126	3.5
	1,200	E91F421VNT122MC65U	50 × 65	C65	0.086	4.6
1,500	E91F421VNT152MC80U	50 × 80	C80	0.069	5.6	
2,200	E91F421VNT222MCA5U	50 × 105	CA5	0.047	7.7	
450 Volts 500 Volts Surge	180	E91F451VSN181MR40U	30 × 40	R40	0.442	1.3
	220	E91F451VSN221MR50U	30 × 50	R50	0.362	1.5
	330	E91F451VSN331MR65U	30 × 65	R65	0.241	2.1
	270	E91F451VSN271MA40U	35 × 40	A40	0.310	1.8
	390	E91F451VSN391MA50U	35 × 50	A50	0.214	2.3
	470	E91F451VSN471MA65U	35 × 65	A65	0.178	2.8
	680	E91F451VND681MA80U	35 × 80	A80	0.123	3.5
	820	E91F451VND821MAA0U	35 × 100	AA0	0.102	4.3
	470	E91F451VND471MB50U	40 × 50	B50	0.178	2.7
	680	E91F451VND681MB65U	40 × 65	B65	0.123	3.5
	820	E91F451VND821MB80U	40 × 80	B80	0.102	4.1
	1,200	E91F451VND122MBA0U	40 × 100	BA0	0.070	5.5
	680	E91F451VNT681MU50U	45 × 50	U50	0.135	3.3
	820	E91F451VNT821MU65U	45 × 65	U65	0.112	3.9
	1,000	E91F451VNT102MU80U	45 × 80	U80	0.092	4.7
	1,500	E91F451VNT152MUA5U	45 × 105	UA5	0.061	6.4
	820	E91F451VNT821MC50U	50 × 50	C50	0.121	3.6
	1,000	E91F451VNT102MC65U	50 × 65	C65	0.100	4.3
1,500	E91F451VNT152MC80U	50 × 80	C80	0.066	5.7	
1,800	E91F451VNT182MCA5U	50 × 105	CA5	0.055	7.1	
500 Volts 550 Volts Surge	120	E91F501VSN121MR40U	30 × 40	R40	0.663	1.0
	180	E91F501VSN181MR50U	30 × 50	R50	0.442	1.4
	270	E91F501VSN271MR65U	30 × 65	R65	0.295	1.9
	180	E91F501VSN181MA40U	35 × 40	A40	0.442	1.5
	270	E91F501VSN271MA50U	35 × 50	A50	0.295	2.0
	390	E91F501VSN391MA65U	35 × 65	A65	0.204	2.6

† For construction and terminal options, refer to the part numbering system for descriptions and codes.

* Refer to diagram of dimensions for detailed case size specifications.

U91F Series

Standard Voltage Ratings - Snap Mount

Rated Voltage (WVDC)	Capacitance (μF)	Global Part Number†	Nominal Case Size* D × L (mm)	Case Size Code	Maximum ESR (Ω) at +25°C, 120Hz	Rated Ripple Current (A rms) at +105°C, 120Hz
500 Volts 550 Volts Surge	470	E91F501VND471MA80U	35 × 80	A80	0.169	3.0
	560	E91F501VND561MAA0U	35 × 100	AA0	0.142	3.7
	330	E91F501VND331MB50U	40 × 50	B50	0.253	2.3
	470	E91F501VND471MB65U	40 × 65	B65	0.178	2.9
	680	E91F501VND681MB80U	40 × 80	B80	0.123	3.8
	820	E91F501VND821MBA0U	40 × 100	BA0	0.102	4.5
	390	E91F501VNT391MU50U	45 × 50	U50	0.225	2.5
	560	E91F501VNT561MU65U	45 × 65	U65	0.156	3.3
	820	E91F501VNT821MU80U	45 × 80	U80	0.107	4.3
	1,000	E91F501VNT102MUA5U	45 × 105	UA5	0.088	5.3
	560	E91F501VNT561MC50U	50 × 50	C50	0.164	3.1
	820	E91F501VNT821MC65U	50 × 65	C65	0.112	4.0
	1,000	E91F501VNT102MC80U	50 × 80	C80	0.092	4.9
	1,200	E91F501VNT122MCA5U	50 × 105	CA5	0.076	6.0

†For construction and terminal options, refer to the part numbering system for descriptions and codes.

*Refer to diagram of dimensions for detailed case size specifications.

U92F Series



- Snap Mount
- Specific Design For Higher Ripple Current
- 350 to 500VDC Voltage Range
- RoHS Compliant
- +85°C Maximum Temperature
- 5,000 Hours Lifetime at +85°C

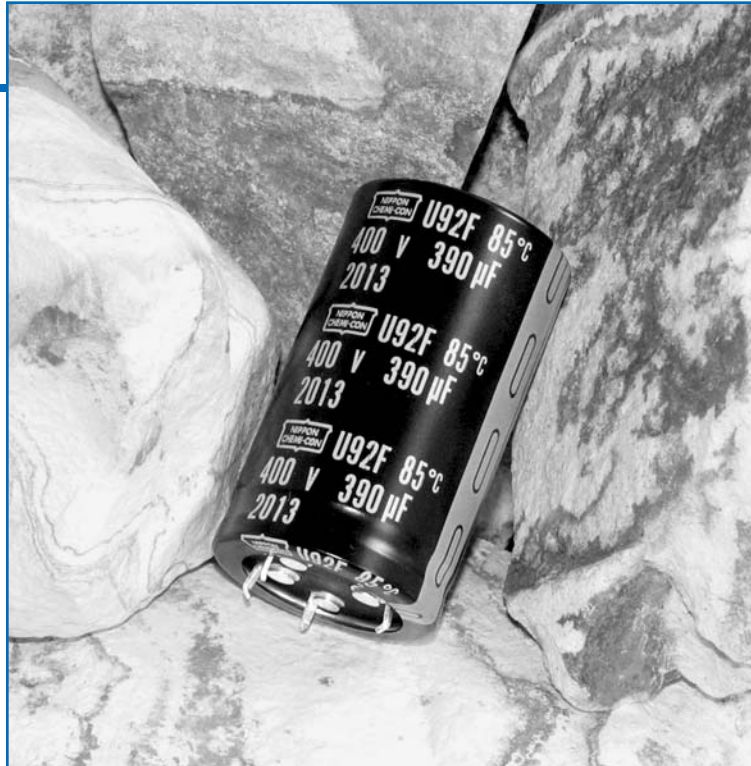

The U92F series is a specifically designed series for higher ripple current capability. The U92F capacitors have an endurance rating of 5,000 hours at +85°C with the rated ripple current applied. All U92F series capacitors are RoHS compliant and offered in a variety of sizes, with or without a PPE end disk, and encased in a standard PVC sleeve or an optional PET sleeve. UL746C compliant exterior insulation material for sleeve and end disk is also available. Snap-in terminals (2, 4 or 5-pin configurations) are available as standard or optional styles depending on case size. Straight standoff terminals (5-pin configuration) are an option for 40, 45 and 50mm can diameters.

Summary of Specifications

- PC board snap-in or straight standoff terminals available as standard or optional styles depending on pin styles and case size.
- Capacitance range: 180 to 3,300µF.
- Voltage range: 350 to 500VDC.
- Category temperature range: -40°C to +85°C.
- Leakage current: $3\sqrt{CV}$ (µA) or 3mA, whichever is smaller, after 5 minutes at +25°C.
- Standard capacitance tolerance: ±20%
- Nominal case size (D × L): 30 × 40mm to 50 × 105mm.
- Rated lifetime: 5,000 hours at +85°C with the rated ripple current applied.

U92F Series

U92F Specifications - Snap Mount

Item	Characteristics																											
Category Temperature Range	- 40 to +85°C																											
Rated Voltage Range	350 to 500VDC																											
Capacitance Range	180 to 3,300µF at +25°C, 120Hz																											
Capacitance Tolerance	±20% (M) at +25°C, 120Hz																											
Leakage Current	$I = 3\sqrt{CV}$ (µA) or 3mA, whichever is smaller, after 5 minutes at +25°C. Where I = Max. leakage current (µA), C = Nominal capacitance (µF) and V = Rated voltage (V)																											
Dissipation Factor (Tan δ)	At +25°C, 120Hz <table border="1" style="margin-left: 20px;"> <tr> <td>Rated Voltage (V)</td> <td>350-400</td> <td>420-500</td> </tr> <tr> <td>Tan δ (DF) Max.</td> <td>0.15</td> <td>0.20</td> </tr> </table>	Rated Voltage (V)	350-400	420-500	Tan δ (DF) Max.	0.15	0.20																					
Rated Voltage (V)	350-400	420-500																										
Tan δ (DF) Max.	0.15	0.20																										
Low Temperature Characteristics	At 120Hz, impedance (Z) ratio between the - 40°C value and +25°C value shall not exceed the values given below. <table border="1" style="margin-left: 20px;"> <tr> <td>Rated Voltage (V)</td> <td>350-400</td> <td>420-500</td> </tr> <tr> <td>Z(-40°C)/Z(+25°C)</td> <td>4</td> <td>8</td> </tr> </table>	Rated Voltage (V)	350-400	420-500	Z(-40°C)/Z(+25°C)	4	8																					
Rated Voltage (V)	350-400	420-500																										
Z(-40°C)/Z(+25°C)	4	8																										
Rated Ripple Current Multipliers	Ambient Temperature (°C) <table border="1" style="margin-left: 20px;"> <tr> <td>+45°C</td> <td>+65°C</td> <td>+85°C</td> </tr> <tr> <td>2.82</td> <td>1.73</td> <td>1.00</td> </tr> </table> Frequency (Hz) <table border="1" style="margin-left: 20px;"> <tr> <td>DC Rated Voltage</td> <td>50Hz</td> <td>120Hz</td> <td>300Hz</td> <td>1kHz</td> <td>10kHz</td> <td>100kHz</td> </tr> <tr> <td>350-450V</td> <td>0.77</td> <td>1.00</td> <td>1.16</td> <td>1.30</td> <td>1.41</td> <td>1.43</td> </tr> <tr> <td>500V</td> <td>0.70</td> <td>1.00</td> <td>1.16</td> <td>1.30</td> <td>1.41</td> <td>1.43</td> </tr> </table>	+45°C	+65°C	+85°C	2.82	1.73	1.00	DC Rated Voltage	50Hz	120Hz	300Hz	1kHz	10kHz	100kHz	350-450V	0.77	1.00	1.16	1.30	1.41	1.43	500V	0.70	1.00	1.16	1.30	1.41	1.43
+45°C	+65°C	+85°C																										
2.82	1.73	1.00																										
DC Rated Voltage	50Hz	120Hz	300Hz	1kHz	10kHz	100kHz																						
350-450V	0.77	1.00	1.16	1.30	1.41	1.43																						
500V	0.70	1.00	1.16	1.30	1.41	1.43																						
Endurance (Load Life)	The following specifications shall be satisfied when the capacitors are restored to +25°C after subjecting them to DC voltage for 5,000 hours at +85°C with the rated ripple current applied. The sum of the DC voltage and peak AC voltage must not exceed the full rated voltage of the capacitors. Capacitance change: ≤ ±20% of initial measured value Tan δ (DF) : ≤ 200% of initial specified value Leakage current : ≤ initial specified value																											
Shelf Life	The following specifications shall be satisfied when the capacitors are restored to +25°C after exposing them for 1,000 hours at +85°C without voltage applied. The rated voltage shall be applied to the capacitors for a minimum of 30 minutes, at least 24 hours and not more than 48 hours before the measurements. Capacitance change: ≤ ±20% of initial measured value Tan δ (DF) : ≤ 150% of initial specified value Leakage current : ≤ initial specified value																											
Custom Designs	Custom CV values per case size and termination type may be available upon request. Contact appropriate representative with specific requirements.																											

U92F
SNAP MOUNT 85°C

U92F Series

Diagram of Dimensions - Snap Mount

Snap Mount

VSN Snap-in $\varnothing 30$ and $\varnothing 35$ standard
VNN Snap-in $\varnothing 30$ and $\varnothing 35$ optional

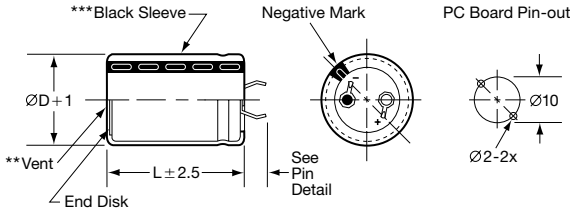

Snap Mount

Unit: mm

VND Snap-in $\varnothing 35$ and $\varnothing 40$ standard; $\varnothing 45$ optional
VSD Snap-in $\varnothing 35$ and $\varnothing 40$ optional

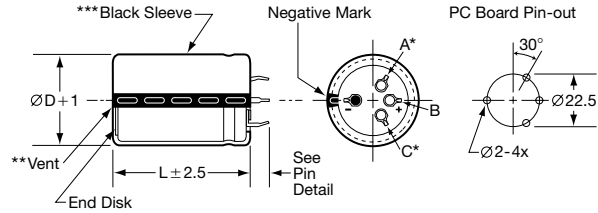

VEN Snap-in $\varnothing 30$ and $\varnothing 35$ optional

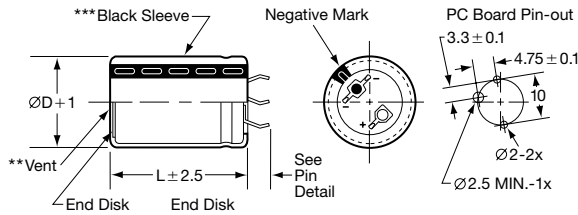

VNT Snap-in $\varnothing 45$ and $\varnothing 50$ standard

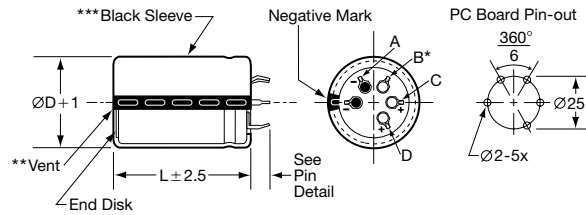

VS, VE & VN Snap-in Pin Dimensions

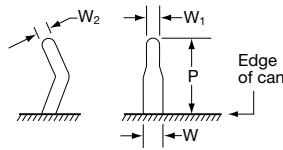

Type	P	W	W ₁	W ₂
VSN $\varnothing 30$	4.0 ± 0.5			
VSN $\varnothing 35$	3.5 ± 0.5			
VNN $\varnothing 30$ - $\varnothing 35$	5.8 ± 1.0			
VEN $\varnothing 30$ - $\varnothing 35$	4.0 ± 0.5	1.5 ± 0.2	0.8 ± 0.1	0.8 ± 0.1
VSD $\varnothing 35$ - $\varnothing 40$	3.5 ± 1.0			
VND $\varnothing 35$ - $\varnothing 45$	5.8 ± 1.0			
VNT $\varnothing 45$ - $\varnothing 50$	5.8 ± 1.0			

Straight Pin Mount

VQT Straight Standoff $\varnothing 40$, $\varnothing 45$ and $\varnothing 50$ optional

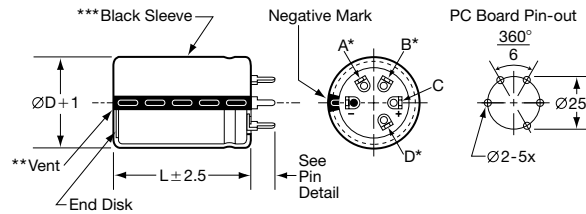

VQ Straight Standoff Pin Dimensions

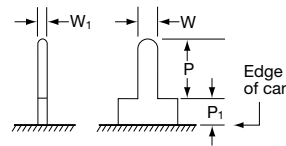

Type	P	P ₁	W	W ₁
Standoff Pin (VQ)	3.75 ± 1.0	2.0 max.	1.5 ± 0.1	0.7 ± 0.2

CAUTION:

* Use the blank terminals for mechanical support only. The blank terminals must not be connected to a solder trace on the PC board but be electrically isolated from the negative and positive terminals.

** The vent may be located either on the bottom or side of the can.

*** The black sleeve with gray stripe negative pin indicator is standard. Also note in some cases, the sleeve color may change slightly due to the operating conditions, however, the discoloration will not impair capacitor function.

U92F Series

Part Numbering System for U92F Series When ordering, always specify complete 18-field global part number.

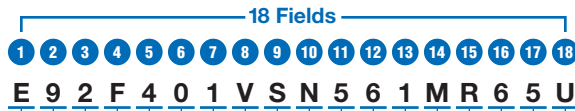

- 9 Supplement Code.** Field 18.
All construction options listed have Sn100% terminal plating.
U = PVC sleeve with PPE end disk.
M = PVC sleeve without end disk.
4 = UL746C compliant insulation for sleeve with end disk.
Other sleeve materials available as options upon request.
- 8 Case Size.** Fields 15, 16 and 17.
The single letter diameter code is inserted in field 15.
R = \varnothing 30mm
A = \varnothing 35mm
B = \varnothing 40mm
U = \varnothing 45mm
C = \varnothing 50mm
The double digit length code is inserted in fields 16 and 17.
40 = 40mm
50 = 50mm
65 = 65mm
80 = 80mm
A0 = 100mm
A5 = 105mm
- 7 Capacitance Tolerance.** Field 14.
M = \pm 20%
- 6 Capacitance.** Fields 11, 12 and 13.
Expressed in Microfarads. The first two digits are significant figures inserted in fields 11 and 12, and the third digit inserted in field 13 indicates the number of zeros for capacitance of 10 μ F or more. R indicates the decimal point for capacitance less than 10 μ F (e.g. 5R6 = 5.6 μ F; 560 = 56 μ F; 561 = 560 μ F; 562 = 5,600 μ F; 563 = 56,000 μ F).
- 5 Dummy Terminals.** Field 10.
N = No dummy terminals.
D = 2 dummy terminals.
T = 3 dummy terminals.
- 4 Terminal Type.** Fields 8 and 9.
VS = Snap-in pins, 4.0mm in length (\varnothing 30 VSN);
3.5mm in length (\varnothing 35 VSN, \varnothing 35 or \varnothing 40 VSD).
VN = Snap-in pins, 5.8mm in length.
VE = Snap-in pins, polarized, \varnothing 30 or \varnothing 35 option.
VQ = Straight standoff pins.
- 3 DC Rated Voltage.** Fields 5, 6 and 7.
Expressed in Volts. The first two digits are significant figures inserted in fields 5 and 6, and the third digit inserted in field 7 indicates the number of zeros for rated voltage of 10VDC or more. R indicates the decimal point for rated voltage less than 10VDC (e.g. 4R0 = 4.0VDC; 400 = 40VDC; 401 = 400VDC).
Rule Exception: Coding for rated voltage 385VDC = 3J1.
- 2 Series Name.** Fields 2, 3 and 4.
Enter the 3-letter/digit series name in fields 2, 3 and 4. If the series name is only 2 letters/digits, place a dash in field 4. For a series name with more than 3 letters/digits, refer to the individual series for the appropriate 3-field series name.
- 1 Capacitor Type.** Field 1.
Aluminum Electrolytic Capacitor (Polar).

U92F Series

Standard Voltage Ratings - Snap Mount

Rated Voltage (WVDC)	Capacitance (µF)	Global Part Number†	Nominal Case Size* D × L (mm)	Case Size Code	Maximum ESR (Ω) at +25°C, 120Hz	Rated Ripple Current (A rms) at +85°C, 120Hz
350 Volts 400 Volts Surge	330	E92F351VSN331MR40U	30 × 40	R40	0.338	2.0
	470	E92F351VSN471MR50U	30 × 50	R50	0.237	2.6
	680	E92F351VSN681MR65U	30 × 65	R65	0.164	3.5
	560	E92F351VSN561MA40U	35 × 40	A40	0.192	3.2
	680	E92F351VSN681MA50U	35 × 50	A50	0.158	3.8
	1,000	E92F351VSN102MA65U	35 × 65	A65	0.107	5.0
	1,200	E92F351VND122MA80U	35 × 80	A80	0.090	5.9
	1,800	E92F351VND182MAA0U	35 × 100	AA0	0.060	8.0
	820	E92F351VND821MB50U	40 × 50	B50	0.126	4.5
	1,200	E92F351VND122MB65U	40 × 65	B65	0.086	5.9
	1,500	E92F351VND152MB80U	40 × 80	B80	0.069	7.1
	2,200	E92F351VND222MBA0U	40 × 100	BA0	0.047	9.4
	1,200	E92F351VNT122MU50U	45 × 50	U50	0.093	5.6
	1,500	E92F351VNT152MU65U	45 × 65	U65	0.074	6.8
	2,200	E92F351VNT222MU80U	45 × 80	U80	0.051	8.9
	2,700	E92F351VNT272MUA5U	45 × 105	UA5	0.041	10.9
	1,500	E92F351VNT152MC50U	50 × 50	C50	0.082	6.2
	2,200	E92F351VNT222MC65U	50 × 65	C65	0.056	8.1
2,700	E92F351VNT272MC80U	50 × 80	C80	0.046	9.8	
3,300	E92F351VNT332MCA5U	50 × 105	CA5	0.037	12.2	
385 Volts 435 Volts Surge	330	E92F3J1VSN331MR40U	30 × 40	R40	0.302	2.1
	390	E92F3J1VSN391MR50U	30 × 50	R50	0.255	2.5
	560	E92F3J1VSN561MR65U	30 × 65	R65	0.178	3.4
	470	E92F3J1VSN471MA40U	35 × 40	A40	0.195	3.1
	560	E92F3J1VSN561MA50U	35 × 50	A50	0.164	3.8
	820	E92F3J1VSN821MA65U	35 × 65	A65	0.112	4.9
	1,200	E92F3J1VND122MA80U	35 × 80	A80	0.076	6.4
	1,500	E92F3J1VND152MAA0U	35 × 100	AA0	0.061	7.9
	820	E92F3J1VND821MB50U	40 × 50	B50	0.121	4.6
	1,200	E92F3J1VND122MB65U	40 × 65	B65	0.083	6.0
	1,500	E92F3J1VND152MB80U	40 × 80	B80	0.066	7.3
	1,800	E92F3J1VND182MBA0U	40 × 100	BA0	0.055	8.7
	1,000	E92F3J1VNT102MU50U	45 × 50	U50	0.111	5.1
	1,500	E92F3J1VNT152MU65U	45 × 65	U65	0.074	6.8
	1,800	E92F3J1VNT182MU80U	45 × 80	U80	0.062	8.0
	2,200	E92F3J1VNT222MUA5U	45 × 105	UA5	0.051	9.9
	1,200	E92F3J1VNT122MC50U	50 × 50	C50	0.103	5.5
	1,800	E92F3J1VNT182MC65U	50 × 65	C65	0.069	7.3
2,200	E92F3J1VNT222MC80U	50 × 80	C80	0.056	8.8	
3,300	E92F3J1VNT332MCA5U	50 × 105	CA5	0.037	12.2	
400 Volts 450 Volts Surge	270	E92F401VSN271MR40U	30 × 40	R40	0.339	2.0
	390	E92F401VSN391MR50U	30 × 50	R50	0.235	2.6
	560	E92F401VSN561MR65U	30 × 65	R65	0.164	3.5
	390	E92F401VSN391MA40U	35 × 40	A40	0.225	2.9
	560	E92F401VSN561MA50U	35 × 50	A50	0.156	3.9
	820	E92F401VSN821MA65U	35 × 65	A65	0.107	5.0
	1,000	E92F401VND102MA80U	35 × 80	A80	0.088	5.9
	1,200	E92F401VND122MAA0U	35 × 100	AA0	0.073	7.2
	680	E92F401VND681MB50U	40 × 50	B50	0.141	4.3
	1,000	E92F401VND102MB65U	40 × 65	B65	0.096	5.6
	1,200	E92F401VND122MB80U	40 × 80	B80	0.080	6.6
	1,800	E92F401VND182MBA0U	40 × 100	BA0	0.053	8.8
	1,000	E92F401VNT102MU50U	45 × 50	U50	0.100	5.4
	1,200	E92F401VNT122MU65U	45 × 65	U65	0.083	6.4

† For construction and terminal options, refer to the part numbering system for descriptions and codes.

* Refer to diagram of dimensions for detailed case size specifications.

U92F Series

Standard Voltage Ratings - Snap Mount

Rated Voltage (WVDC)	Capacitance (µF)	Global Part Number†	Nominal Case Size* D × L (mm)	Case Size Code	Maximum ESR (Ω) at +25°C, 120Hz	Rated Ripple Current (A rms) at +85°C, 120Hz
400 Volts 450 Volts Surge	1,800	E92F401VNT182MU80U	45 × 80	U80	0.055	8.5
	2,200	E92F401VNT222MUA5U	45 × 105	UA5	0.045	10.4
	1,200	E92F401VNT122MC50U	50 × 50	C50	0.093	5.6
	1,800	E92F401VNT182MC65U	50 × 65	C65	0.062	7.7
	2,200	E92F401VNT222MC80U	50 × 80	C80	0.051	9.3
	2,700	E92F401VNT272MCA5U	50 × 105	CA5	0.041	11.6
420 Volts 470 Volts Surge	220	E92F421VSN221MR40U	30 × 40	R40	0.331	2.0
	330	E92F421VSN331MR50U	30 × 50	R50	0.241	2.6
	470	E92F421VSN471MR65U	30 × 65	R65	0.172	3.5
	390	E92F421VSN391MA40U	35 × 40	A40	0.213	3.0
	560	E92F421VSN561MA50U	35 × 50	A50	0.155	3.9
	680	E92F421VSN681MA65U	35 × 65	A65	0.110	5.0
	1,000	E92F421VND102MA80U	35 × 80	A80	0.086	6.0
	1,200	E92F421VND122MAA0U	35 × 100	AA0	0.066	7.6
	560	E92F421VND561MB50U	40 × 50	B50	0.131	4.4
	820	E92F421VND821MB65U	40 × 65	B65	0.094	5.7
	1,200	E92F421VND122MB80U	40 × 80	B80	0.073	6.9
	1,500	E92F421VND152MBA0U	40 × 100	BA0	0.057	8.6
	820	E92F421VNT821MU50U	45 × 50	U50	0.110	5.1
	1,200	E92F421VNT122MU65U	45 × 65	U65	0.079	6.6
	1,500	E92F421VNT152MU80U	45 × 80	U80	0.062	8.0
	1,800	E92F421VNT182MUA5U	45 × 105	UA5	0.045	10.5
	1,000	E92F421VNT102MC50U	50 × 50	C50	0.093	5.6
	1,500	E92F421VNT152MC65U	50 × 65	C65	0.067	7.4
1,800	E92F421VNT182MC80U	50 × 80	C80	0.052	9.1	
2,700	E92F421VNT272MCA5U	50 × 105	CA5	0.038	12.1	
450 Volts 500 Volts Surge	220	E92F451VSN221MR40U	30 × 40	R40	0.340	2.0
	330	E92F451VSN331MR50U	30 × 50	R50	0.248	2.6
	390	E92F451VSN391MR65U	30 × 65	R65	0.177	3.4
	390	E92F451VSN391MA40U	35 × 40	A40	0.249	2.8
	470	E92F451VSN471MA50U	35 × 50	A50	0.159	3.8
	680	E92F451VSN681MA65U	35 × 65	A65	0.113	4.9
	820	E92F451VND821MA80U	35 × 80	A80	0.088	5.9
	1,000	E92F451VND102MAA0U	35 × 100	AA0	0.068	7.5
	560	E92F451VND561MB50U	40 × 50	B50	0.135	4.4
	820	E92F451VND821MB65U	40 × 65	B65	0.097	5.6
	1,000	E92F451VND102MB80U	40 × 80	B80	0.075	6.8
	1,200	E92F451VND122MBA0U	40 × 100	BA0	0.058	8.4
	680	E92F451VNT681MU50U	45 × 50	U50	0.114	5.0
	1,000	E92F451VNT102MU65U	45 × 65	U65	0.081	6.5
	1,200	E92F451VNT122MU80U	45 × 80	U80	0.063	7.9
	1,800	E92F451VNT182MUA5U	45 × 105	UA5	0.046	10.3
	820	E92F451VNT821MC50U	50 × 50	C50	0.093	5.6
	1,200	E92F451VNT122MC65U	50 × 65	C65	0.066	7.4
1,500	E92F451VNT152MC80U	50 × 80	C80	0.052	9.2	
2,200	E92F451VNT222MCA5U	50 × 105	CA5	0.038	12.1	
500 Volts 550 Volts Surge	180	E92F501VSN181MR40T	30 × 40	R40	0.464	1.7
	220	E92F501VSN221MR50T	30 × 50	R50	0.380	2.1
	330	E92F501VSN331MR65T	30 × 65	R65	0.253	2.8
	270	E92F501VSN271MA40T	35 × 40	A40	0.295	2.6
	330	E92F501VSN331MA50T	35 × 50	A50	0.241	3.1
	470	E92F501VSN471MA65T	35 × 65	A65	0.169	4.0

† For construction and terminal options, refer to the part numbering system for descriptions and codes.

* Refer to diagram of dimensions for detailed case size specifications.

U92F Series

Standard Voltage Ratings - Snap Mount

Rated Voltage (WVDC)	Capacitance (μF)	Global Part Number†	Nominal Case Size* D × L (mm)	Case Size Code	Maximum ESR (Ω) at +25°C, 120Hz	Rated Ripple Current (A rms) at +85°C, 120Hz
500 Volts 550 Volts Surge	560	E92F501VND561MA80U	35 × 80	A80	0.142	4.7
	820	E92F501VND821MAA0U	35 × 100	AA0	0.097	6.2
	470	E92F501VND471MB50U	40 × 50	B50	0.178	3.8
	680	E92F501VND681MB65U	40 × 65	B65	0.123	5.0
	820	E92F501VND821MB80U	40 × 80	B80	0.102	5.8
	1,200	E92F501VND122MBA0U	40 × 100	BA0	0.070	7.7
	560	E92F501VNT561MU50U	45 × 50	U50	0.164	4.2
	820	E92F501VNT821MU65U	45 × 65	U65	0.112	5.5
	1,200	E92F501VNT122MU80U	45 × 80	U80	0.076	7.2
	1,500	E92F501VNT152MUA5U	45 × 105	UA5	0.061	9.0
	820	E92F501VNT821MC50U	50 × 50	C50	0.121	4.9
	1,200	E92F501VNT122MC65U	50 × 65	C65	0.083	6.6
	1,500	E92F501VNT152MC80U	50 × 80	C80	0.066	8.1
	1,800	E92F501VNT182MCA5U	50 × 105	CA5	0.055	10.0

† For construction and terminal options, refer to the part numbering system for descriptions and codes.

* Refer to diagram of dimensions for detailed case size specifications.

U92L Series



- Snap Mount
- Specific Design For Higher Ripple Current
- 350 to 500VDC Voltage Range
- RoHS Compliant
- +85°C Maximum Temperature
- 10,000 Hours Lifetime at +85°C

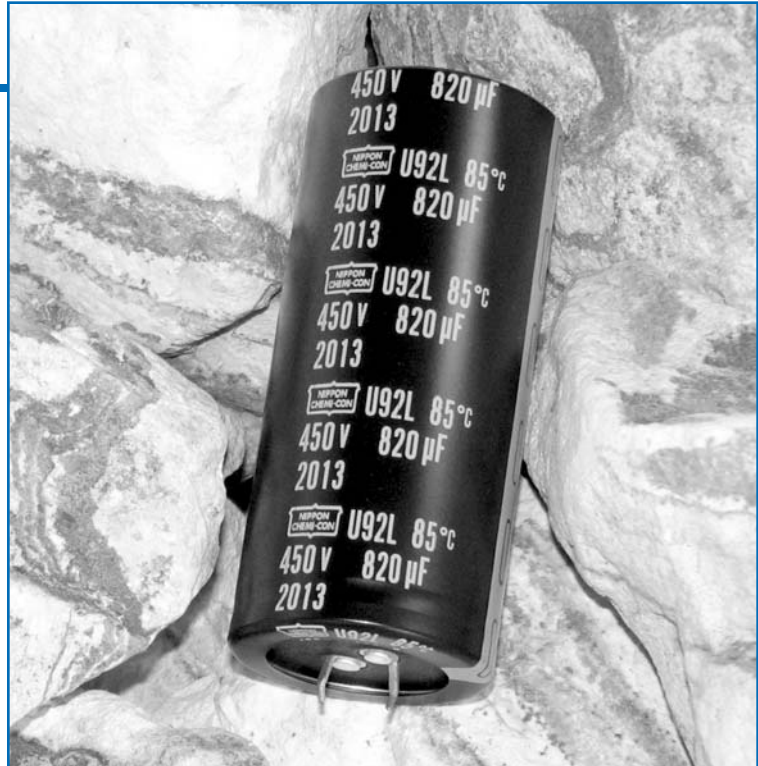

The U92L series is a longer life series specifically designed for higher ripple current capability. The U92L capacitors have an endurance rating of 10,000 hours at +85°C with the rated ripple current applied. All U92L series capacitors are RoHS compliant and offered in a variety of sizes, with or without a PPE end disk, and encased in a standard PVC sleeve or optional PET sleeve. UL746C compliant exterior insulation material for sleeve and end disk is also available. Snap-in terminals (2, 4 or 5-pin configurations) are available as standard or optional styles depending on case size. Straight standoff terminals (5-pin configuration) are an option for 40, 45 and 50mm can diameters.

Summary of Specifications

- PC board snap-in or straight standoff terminals available as standard or optional styles depending on pin styles and case size.
- Capacitance range: 150 to 3,300µF.
- Voltage range: 350 to 500VDC.
- Category temperature range: -40°C to +85°C.
- Leakage current: $3\sqrt{CV}$ (µA) or 3mA, whichever is smaller, after 5 minutes at +25°C.
- Standard capacitance tolerance: ±20%
- Nominal case size (D×L): 30×40mm to 50×105mm.
- Rated lifetime: 10,000 hours at +85°C with the rated ripple current applied.

U92L Series

U92L Specifications - Snap Mount

Item	Characteristics																											
Category Temperature Range	- 40 to +85°C																											
Rated Voltage Range	350 to 500VDC																											
Capacitance Range	150 to 3,300 μ F at +25°C, 120Hz																											
Capacitance Tolerance	\pm 20% (M) at +25°C, 120Hz																											
Leakage Current	$I = 3\sqrt{CV}$ (μ A) or 3mA, whichever is smaller, after 5 minutes at +25°C. Where I = Max. leakage current (μ A), C = Nominal capacitance (μ F) and V = Rated voltage (V)																											
Dissipation Factor (Tan δ)	At +25°C, 120Hz <table border="1"> <tr> <td>Rated Voltage (V)</td> <td>350-400</td> <td>420-500</td> </tr> <tr> <td>Tan δ (DF) Max.</td> <td>0.15</td> <td>0.20</td> </tr> </table>	Rated Voltage (V)	350-400	420-500	Tan δ (DF) Max.	0.15	0.20																					
Rated Voltage (V)	350-400	420-500																										
Tan δ (DF) Max.	0.15	0.20																										
Low Temperature Characteristics	At 120Hz, impedance (Z) ratio between the - 40°C value and +25°C value shall not exceed the values given below. <table border="1"> <tr> <td>Rated Voltage (V)</td> <td>350-400</td> <td>420-500</td> </tr> <tr> <td>Z(-40°C) / Z(+25°C)</td> <td>4</td> <td>8</td> </tr> </table>	Rated Voltage (V)	350-400	420-500	Z(-40°C) / Z(+25°C)	4	8																					
Rated Voltage (V)	350-400	420-500																										
Z(-40°C) / Z(+25°C)	4	8																										
Rated Ripple Current Multipliers	Ambient Temperature (°C) <table border="1"> <tr> <td>+45°C</td> <td>+65°C</td> <td>+85°C</td> </tr> <tr> <td>2.82</td> <td>1.73</td> <td>1.00</td> </tr> </table> Frequency (Hz) <table border="1"> <tr> <td>DC Rated Voltage</td> <td>50Hz</td> <td>120Hz</td> <td>300Hz</td> <td>1kHz</td> <td>10kHz</td> <td>100kHz</td> </tr> <tr> <td>350-450V</td> <td>0.77</td> <td>1.00</td> <td>1.16</td> <td>1.30</td> <td>1.41</td> <td>1.43</td> </tr> <tr> <td>500V</td> <td>0.70</td> <td>1.00</td> <td>1.16</td> <td>1.30</td> <td>1.41</td> <td>1.43</td> </tr> </table>	+45°C	+65°C	+85°C	2.82	1.73	1.00	DC Rated Voltage	50Hz	120Hz	300Hz	1kHz	10kHz	100kHz	350-450V	0.77	1.00	1.16	1.30	1.41	1.43	500V	0.70	1.00	1.16	1.30	1.41	1.43
+45°C	+65°C	+85°C																										
2.82	1.73	1.00																										
DC Rated Voltage	50Hz	120Hz	300Hz	1kHz	10kHz	100kHz																						
350-450V	0.77	1.00	1.16	1.30	1.41	1.43																						
500V	0.70	1.00	1.16	1.30	1.41	1.43																						
Endurance (Load Life)	The following specifications shall be satisfied when the capacitors are restored to +25°C after subjecting them to DC voltage for 10,000 hours at +85°C with the rated ripple current applied. The sum of the DC voltage and peak AC voltage must not exceed the full rated voltage of the capacitors. Capacitance change: $\leq \pm 20\%$ of initial measured value Tan δ (DF) : $\leq 200\%$ of initial specified value Leakage current : \leq initial specified value																											
Shelf Life	The following specifications shall be satisfied when the capacitors are restored to +25°C after exposing them for 1,000 hours at +85°C without voltage applied. The rated voltage shall be applied to the capacitors for a minimum of 30 minutes, at least 24 hours and not more than 48 hours before the measurements. Capacitance change: $\leq \pm 20\%$ of initial measured value Tan δ (DF) : $\leq 150\%$ of initial specified value Leakage current : \leq initial specified value																											
Custom Designs	Custom CV values per case size and termination type may be available upon request. Contact appropriate representative with specific requirements.																											

U92L Series

Diagram of Dimensions - Snap Mount

Snap Mount

VSN Snap-in $\varnothing 30$ and $\varnothing 35$ standard
VNN Snap-in $\varnothing 30$ and $\varnothing 35$ optional

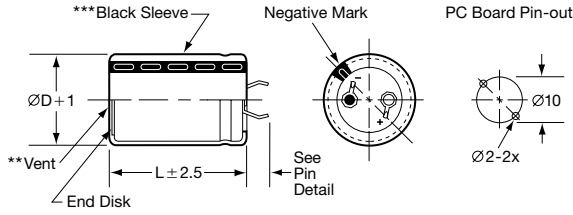

Snap Mount

Unit: mm

VND Snap-in $\varnothing 35$ and $\varnothing 40$ standard; $\varnothing 45$ optional
VSD Snap-in $\varnothing 35$ and $\varnothing 40$ optional

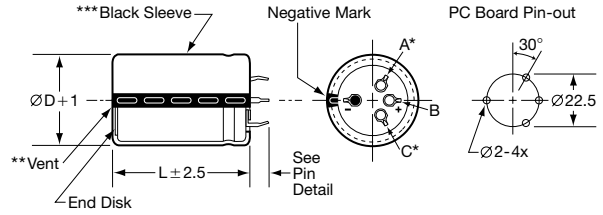

VEN Snap-in $\varnothing 30$ and $\varnothing 35$ optional

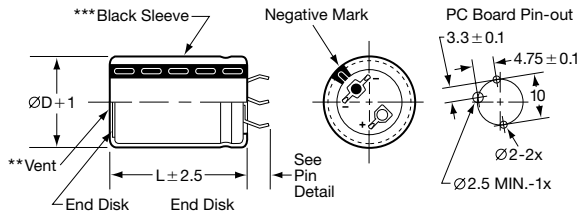

VNT Snap-in $\varnothing 45$ and $\varnothing 50$ standard

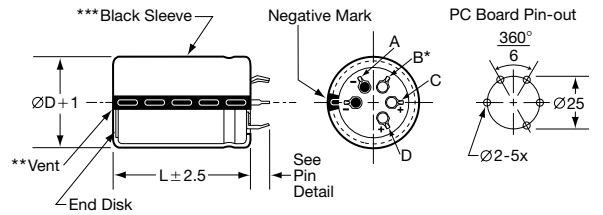

VS, VE & VN Snap-in Pin Dimensions

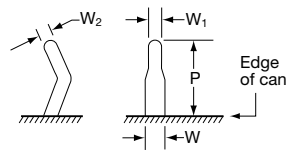

Type	P	W	W ₁	W ₂
VSN $\varnothing 30$	4.0 ± 0.5	1.5 ± 0.2	0.8 ± 0.1	0.8 ± 0.1
VSN $\varnothing 35$	3.5 ± 0.5			
VNN $\varnothing 30-\varnothing 35$	5.8 ± 1.0			
VEN $\varnothing 30-\varnothing 35$	4.0 ± 0.5			
VSD $\varnothing 35-\varnothing 40$	3.5 ± 1.0			
VND $\varnothing 35-\varnothing 45$	5.8 ± 1.0			
VNT $\varnothing 45-\varnothing 50$	5.8 ± 1.0			

Straight Pin Mount

VQT Straight Standoff $\varnothing 40$, $\varnothing 45$ and $\varnothing 50$ optional

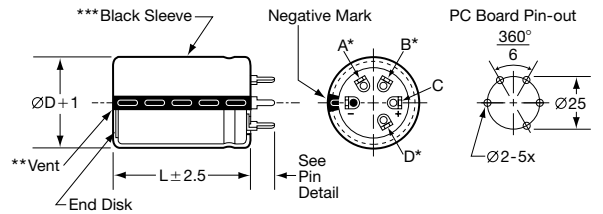

VQ Straight Standoff Pin Dimensions

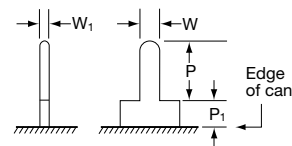

Type	P	P ₁	W	W ₁
Standoff Pin (VQ)	3.75 ± 1.0	2.0 max.	1.5 ± 0.1	0.7 ± 0.2

CAUTION:

* Use the blank terminals for mechanical support only. The blank terminals must not be connected to a solder trace on the PC board but be electrically isolated from the negative and positive terminals.

** The vent may be located either on the bottom or side of the can.

*** The black sleeve with gray stripe negative pin indicator is standard. Also note in some cases, the sleeve color may change slightly due to the operating conditions, however, the discoloration will not impair capacitor function.

U92L Series

Part Numbering System for U92L Series When ordering, always specify complete 18-field global part number.

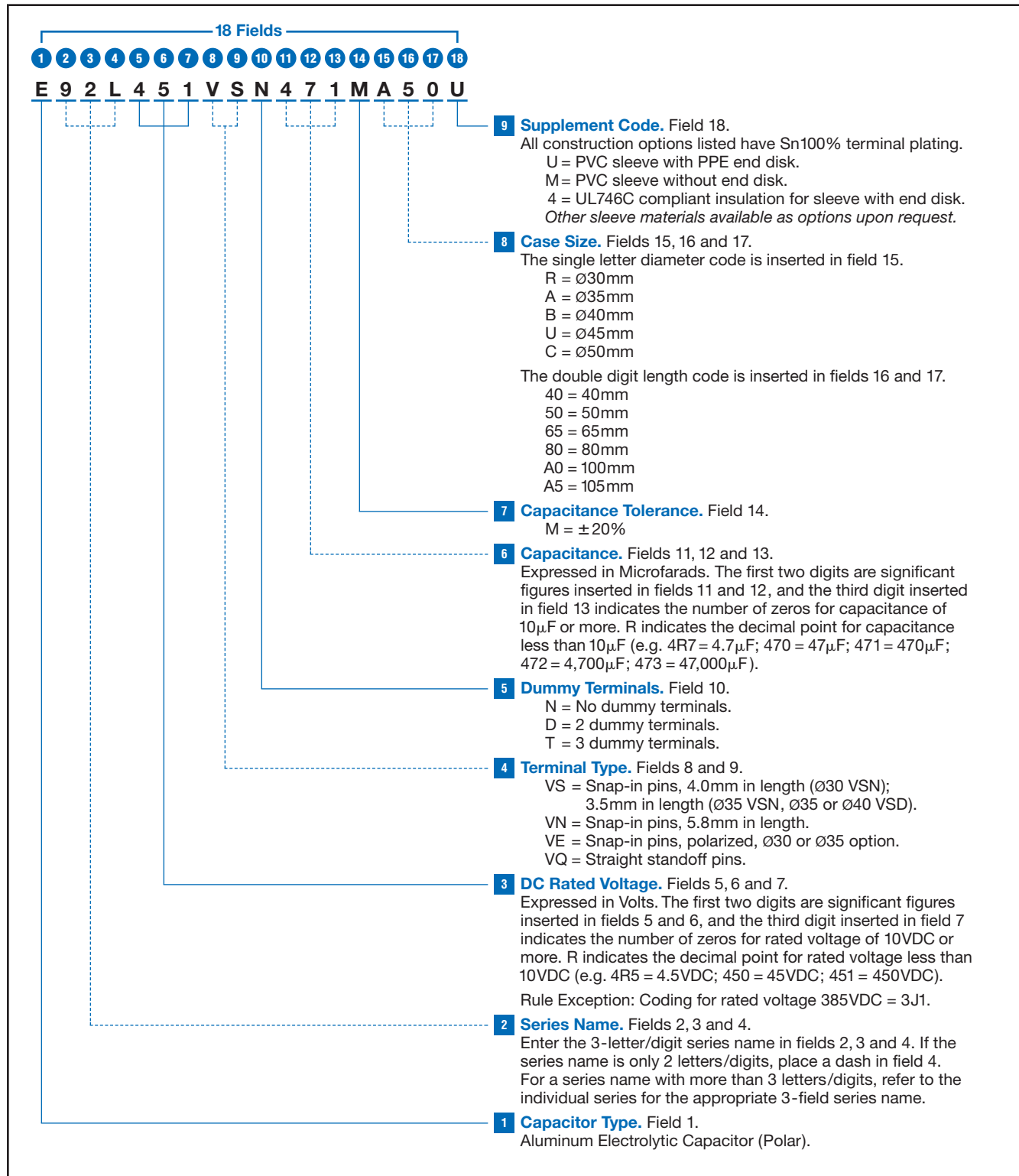

U92L Series

Standard Voltage Ratings - Snap Mount

Rated Voltage (WVDC)	Capacitance (µF)	Global Part Number†	Nominal Case Size* D × L (mm)	Case Size Code	Maximum ESR (Ω) at +25°C, 120Hz	Rated Ripple Current (A rms) at +85°C, 120Hz
350 Volts 400 Volts Surge	330	E92L351VSN331MR40U	30 × 40	R40	0.314	2.1
	470	E92L351VSN471MR50U	30 × 50	R50	0.220	2.7
	680	E92L351VSN681MR65U	30 × 65	R65	0.152	3.7
	470	E92L351VSN471MA40U	35 × 40	A40	0.212	3.0
	680	E92L351VSN681MA50U	35 × 50	A50	0.146	4.0
	1,000	E92L351VSN102MA65U	35 × 65	A65	0.100	5.2
	1,200	E92L351VND122MA80U	35 × 80	A80	0.083	6.1
	1,500	E92L351VND152MAA0U	35 × 100	AA0	0.066	7.6
	820	E92L351VND821MB50U	40 × 50	B50	0.126	4.5
	1,200	E92L351VND122MB65U	40 × 65	B65	0.086	5.9
	1,500	E92L351VND152MB80U	40 × 80	B80	0.069	7.1
	2,200	E92L351VND222MBA0U	40 × 100	BA0	0.047	9.4
	1,200	E92L351VNT122MU50U	45 × 50	U50	0.096	5.5
	1,500	E92L351VNT152MU65U	45 × 65	U65	0.077	6.7
	2,200	E92L351VNT222MU80U	45 × 80	U80	0.052	8.7
	2,700	E92L351VNT272MUA5U	45 × 105	UA5	0.043	10.7
	1,500	E92L351VNT152MC50U	50 × 50	C50	0.088	5.8
	2,200	E92L351VNT222MC65U	50 × 65	C65	0.060	7.8
2,700	E92L351VNT272MC80U	50 × 80	C80	0.049	9.5	
3,300	E92L351VNT332MCA5U	50 × 105	CA5	0.040	11.8	
385 Volts 435 Volts Surge	270	E92L3J1VSN271MR40U	30 × 40	R40	0.369	1.9
	390	E92L3J1VSN391MR50U	30 × 50	R50	0.255	2.5
	560	E92L3J1VSN561MR65U	30 × 65	R65	0.178	3.4
	470	E92L3J1VSN471MA40U	35 × 40	A40	0.203	3.1
	560	E92L3J1VSN561MA50U	35 × 50	A50	0.171	3.7
	820	E92L3J1VSN821MA65U	35 × 65	A65	0.117	4.8
	1,200	E92L3J1VND122MA80U	35 × 80	A80	0.080	6.2
	1,500	E92L3J1VND152MAA0U	35 × 100	AA0	0.064	7.7
	820	E92L3J1VND821MB50U	40 × 50	B50	0.121	4.6
	1,200	E92L3J1VND122MB65U	40 × 65	B65	0.083	6.0
	1,500	E92L3J1VND152MB80U	40 × 80	B80	0.066	7.3
	1,800	E92L3J1VND182MBA0U	40 × 100	BA0	0.055	8.7
	1,000	E92L3J1VNT102MU50U	45 × 50	U50	0.107	5.2
	1,200	E92L3J1VNT122MU65U	45 × 65	U65	0.090	6.2
	1,800	E92L3J1VNT182MU80U	45 × 80	U80	0.060	8.2
	2,200	E92L3J1VNT222MUA5U	45 × 105	UA5	0.049	10.0
	1,200	E92L3J1VNT122MC50U	50 × 50	C50	0.103	5.5
	1,800	E92L3J1VNT182MC65U	50 × 65	C65	0.069	7.3
2,200	E92L3J1VNT222MC80U	50 × 80	C80	0.056	8.8	
2,700	E92L3J1VNT272MCA5U	50 × 105	CA5	0.046	11.0	
400 Volts 450 Volts Surge	270	E92L401VSN271MR40U	30 × 40	R40	0.354	1.9
	390	E92L401VSN391MR50U	30 × 50	R50	0.245	2.6
	560	E92L401VSN561MR65U	30 × 65	R65	0.171	3.5
	390	E92L401VSN391MA40U	35 × 40	A40	0.235	2.9
	560	E92L401VSN561MA50U	35 × 50	A50	0.164	3.8
	820	E92L401VSN821MA65U	35 × 65	A65	0.112	4.9
	1,000	E92L401VND102MA80U	35 × 80	A80	0.092	5.8
	1,200	E92L401VND122MAA0U	35 × 100	AA0	0.076	7.0
	680	E92L401VND681MB50U	40 × 50	B50	0.146	4.2
	1,000	E92L401VND102MB65U	40 × 65	B65	0.100	5.5
	1,200	E92L401VND122MB80U	40 × 80	B80	0.083	6.5
	1,800	E92L401VND182MBA0U	40 × 100	BA0	0.055	8.7
	1,000	E92L401VNT102MU50U	45 × 50	U50	0.107	5.2
	1,200	E92L401VNT122MU65U	45 × 65	U65	0.090	6.2

†For construction and terminal options, refer to the part numbering system for descriptions and codes.

*Refer to diagram of dimensions for detailed case size specifications.

U92L Series

Standard Voltage Ratings - Snap Mount

Rated Voltage (WVDC)	Capacitance (µF)	Global Part Number†	Nominal Case Size* D × L (mm)	Case Size Code	Maximum ESR (Ω) at +25°C, 120Hz	Rated Ripple Current (A rms) at +85°C, 120Hz
400 Volts 450 Volts Surge	1,500	E92L401VNT152MU80U	45 × 80	U80	0.072	7.5
	2,200	E92L401VNT222MUA5U	45 × 105	UA5	0.049	10.0
	1,200	E92L401VNT122MC50U	50 × 50	C50	0.100	5.4
	1,500	E92L401VNT152MC65U	50 × 65	C65	0.080	6.8
	2,200	E92L401VNT222MC80U	50 × 80	C80	0.054	9.0
	2,700	E92L401VNT272MCA5U	50 × 105	CA5	0.044	11.2
420 Volts 470 Volts Surge	220	E92L421VSN221MR40U	30 × 40	R40	0.408	1.8
	330	E92L421VSN331MR50U	30 × 50	R50	0.298	2.3
	470	E92L421VSN471MR65U	30 × 65	R65	0.212	3.1
	390	E92L421VSN391MA40U	35 × 40	A40	0.264	2.7
	560	E92L421VSN561MA50U	35 × 50	A50	0.193	3.5
	680	E92L421VSN681MA65U	35 × 65	A65	0.137	4.4
	820	E92L421VND821MA80U	35 × 80	A80	0.106	5.4
	1,200	E92L421VND122MAA0U	35 × 100	AA0	0.082	6.8
	680	E92L421VND681MB50U	40 × 50	B50	0.150	4.2
	820	E92L421VND821MB65U	40 × 65	B65	0.107	5.3
	1,200	E92L421VND122MB80U	40 × 80	B80	0.084	6.5
	1,500	E92L421VND152MBA0U	40 × 100	BA0	0.065	8.0
	820	E92L421VNT821MU50U	45 × 50	U50	0.130	4.7
	1,200	E92L421VNT122MU65U	45 × 65	U65	0.093	6.1
	1,500	E92L421VNT152MU80U	45 × 80	U80	0.073	7.4
	1,800	E92L421VNT182MUA5U	45 × 105	UA5	0.053	9.6
	1,000	E92L421VNT102MC50U	50 × 50	C50	0.113	5.1
	1,500	E92L421VNT152MC65U	50 × 65	C65	0.081	6.7
1,800	E92L421VNT182MC80U	50 × 80	C80	0.063	8.3	
2,200	E92L421VNT222MCA5U	50 × 105	CA5	0.046	10.9	
450 Volts 500 Volts Surge	220	E92L451VSN221MR40U	30 × 40	R40	0.428	1.8
	330	E92L451VSN331MR50U	30 × 50	R50	0.312	2.3
	390	E92L451VSN391MR65U	30 × 65	R65	0.222	3.0
	330	E92L451VSN331MA40U	35 × 40	A40	0.318	2.5
	470	E92L451VSN471MA50U	35 × 50	A50	0.202	3.4
	680	E92L451VSN681MA65U	35 × 65	A65	0.143	4.3
	820	E92L451VND821MA80U	35 × 80	A80	0.111	5.3
	1,000	E92L451VND102MAA0U	35 × 100	AA0	0.086	6.6
	560	E92L451VND561MB50U	40 × 50	B50	0.170	3.9
	820	E92L451VND821MB65U	40 × 65	B65	0.122	5.0
	1,000	E92L451VND102MB80U	40 × 80	B80	0.095	6.1
	1,200	E92L451VND122MBA0U	40 × 100	BA0	0.073	7.5
	680	E92L451VNT681MU50U	45 × 50	U50	0.142	4.5
	1,000	E92L451VNT102MU65U	45 × 65	U65	0.102	5.8
	1,200	E92L451VNT122MU80U	45 × 80	U80	0.079	7.1
	1,800	E92L451VNT182MUA5U	45 × 105	UA5	0.058	9.2
	820	E92L451VNT821MC50U	50 × 50	C50	0.120	5.0
	1,200	E92L451VNT122MC65U	50 × 65	C65	0.086	6.5
1,500	E92L451VNT152MC80U	50 × 80	C80	0.067	8.1	
2,200	E92L451VNT222MCA5U	50 × 105	CA5	0.049	10.6	
500 Volts 550 Volts Surge	150	E92L501VSN151MR40U	30 × 40	R40	0.557	1.6
	220	E92L501VSN221MR50U	30 × 50	R50	0.380	2.1
	270	E92L501VSN271MR65U	30 × 65	R65	0.310	2.6
	220	E92L501VSN221MA40U	35 × 40	A40	0.380	2.3
	330	E92L501VSN331MA50U	35 × 50	A50	0.253	3.0
	390	E92L501VSN391MA65U	35 × 65	A65	0.214	3.6

† For construction and terminal options, refer to the part numbering system for descriptions and codes.

* Refer to diagram of dimensions for detailed case size specifications.

U92L Series

Standard Voltage Ratings - Snap Mount

Rated Voltage (WVDC)	Capacitance (µF)	Global Part Number†	Nominal Case Size* D × L (mm)	Case Size Code	Maximum ESR (Ω) at +25°C, 120Hz	Rated Ripple Current (A rms) at +85°C, 120Hz
500 Volts 550 Volts Surge	560	E92L501VND561MA80U	35 × 80	A80	0.149	4.6
	680	E92L501VND681MAA0U	35 × 100	AA0	0.123	5.6
	390	E92L501VND391MB50U	40 × 50	B50	0.225	3.4
	560	E92L501VND561MB65U	40 × 65	B65	0.156	4.4
	680	E92L501VND681MB80U	40 × 80	B80	0.129	5.2
	1,000	E92L501VND102MBA0U	40 × 100	BA0	0.088	6.9
	560	E92L501VNT561MU50U	45 × 50	U50	0.164	4.2
	820	E92L501VNT821MU65U	45 × 65	U65	0.112	5.5
	1,000	E92L501VNT102MU80U	45 × 80	U80	0.092	6.6
	1,500	E92L501VNT152MUA5U	45 × 105	UA5	0.061	9.0
	680	E92L501VNT681MC50U	50 × 50	C50	0.146	4.5
	1,000	E92L501VNT102MC65U	50 × 65	C65	0.100	6.1
	1,200	E92L501VNT122MC80U	50 × 80	C80	0.083	7.2
	1,800	E92L501VNT182MCA5U	50 × 105	CA5	0.055	10.0

†For construction and terminal options, refer to the part numbering system for descriptions and codes.

* Refer to diagram of dimensions for detailed case size specifications.

U92X Series



- Snap Mount
- Specific Design For Higher Ripple Current
- 350 to 500VDC Voltage Range
- RoHS Compliant
- +85°C Maximum Temperature
- 15,000 Hours Lifetime at +85°C



The U92X series is a longest life series specifically designed for higher ripple current capability. The U92X capacitors have an endurance rating of 15,000 hours at +85°C with the rated ripple current applied. All U92X series capacitors are RoHS compliant and offered in a variety of sizes, with or without a PPE end disk, and encased in a standard PVC sleeve or optional PET sleeve. UL746C compliant exterior insulation material for sleeve and end disk is also available. Snap-in terminals (2, 4 or 5-pin configurations) are available as standard or optional styles depending on case size. Straight standoff terminals (5-pin configuration) are an option for 40, 45 and 50mm can diameters.

Summary of Specifications

- PC board snap-in or straight standoff terminals available as standard or optional styles depending on pin styles and case size.
- Capacitance range: 150 to 3,300µF.
- Voltage range: 350 to 500VDC.
- Category temperature range: -40°C to +85°C.
- Leakage current: $3\sqrt{CV}$ (µA) or 3mA, whichever is smaller, after 5 minutes at +25°C.
- Standard capacitance tolerance: ±20%
- Nominal case size (D × L): 30 × 40mm to 50 × 105mm.
- Rated lifetime: 15,000 hours at +85°C with the rated ripple current applied.

U92X Series

U92X Specifications - Snap Mount

Item	Characteristics																											
Category Temperature Range	-40 to +85°C																											
Rated Voltage Range	350 to 500VDC																											
Capacitance Range	150 to 3,300 μ F at +25°C, 120Hz																											
Capacitance Tolerance	\pm 20% (M) at +25°C, 120Hz																											
Leakage Current	$I = 3\sqrt{CV}$ (μ A) or 3mA, whichever is smaller, after 5 minutes at +25°C. Where I = Max. leakage current (μ A), C = Nominal capacitance (μ F) and V = Rated voltage (V)																											
Dissipation Factor (Tan δ)	At +25°C, 120Hz <table border="1"> <tr> <td>Rated Voltage (V)</td> <td>350-400</td> <td>420-500</td> </tr> <tr> <td>Tan δ (DF) Max.</td> <td>0.15</td> <td>0.20</td> </tr> </table>	Rated Voltage (V)	350-400	420-500	Tan δ (DF) Max.	0.15	0.20																					
Rated Voltage (V)	350-400	420-500																										
Tan δ (DF) Max.	0.15	0.20																										
Low Temperature Characteristics	At 120Hz, impedance (Z) ratio between the -40°C value and +25°C value shall not exceed the values given below. <table border="1"> <tr> <td>Rated Voltage (V)</td> <td>350-400</td> <td>420-500</td> </tr> <tr> <td>Z(-40°C)/Z(+25°C)</td> <td>4</td> <td>8</td> </tr> </table>	Rated Voltage (V)	350-400	420-500	Z(-40°C)/Z(+25°C)	4	8																					
Rated Voltage (V)	350-400	420-500																										
Z(-40°C)/Z(+25°C)	4	8																										
Rated Ripple Current Multipliers	Ambient Temperature (°C) <table border="1"> <tr> <td>+45°C</td> <td>+65°C</td> <td>+85°C</td> </tr> <tr> <td>2.82</td> <td>1.73</td> <td>1.00</td> </tr> </table> Frequency (Hz) <table border="1"> <tr> <td>DC Rated Voltage</td> <td>50Hz</td> <td>120Hz</td> <td>300Hz</td> <td>1kHz</td> <td>10kHz</td> <td>100kHz</td> </tr> <tr> <td>350-450V</td> <td>0.77</td> <td>1.00</td> <td>1.16</td> <td>1.30</td> <td>1.41</td> <td>1.43</td> </tr> <tr> <td>500V</td> <td>0.70</td> <td>1.00</td> <td>1.16</td> <td>1.30</td> <td>1.41</td> <td>1.43</td> </tr> </table>	+45°C	+65°C	+85°C	2.82	1.73	1.00	DC Rated Voltage	50Hz	120Hz	300Hz	1kHz	10kHz	100kHz	350-450V	0.77	1.00	1.16	1.30	1.41	1.43	500V	0.70	1.00	1.16	1.30	1.41	1.43
+45°C	+65°C	+85°C																										
2.82	1.73	1.00																										
DC Rated Voltage	50Hz	120Hz	300Hz	1kHz	10kHz	100kHz																						
350-450V	0.77	1.00	1.16	1.30	1.41	1.43																						
500V	0.70	1.00	1.16	1.30	1.41	1.43																						
Endurance (Load Life)	The following specifications shall be satisfied when the capacitors are restored to +25°C after subjecting them to DC voltage for 15,000 hours at +85°C with the rated ripple current applied. The sum of the DC voltage and peak AC voltage must not exceed the full rated voltage of the capacitors. Capacitance change: $\leq \pm 20\%$ of initial measured value Tan δ (DF) : $\leq 200\%$ of initial specified value Leakage current : \leq initial specified value																											
Shelf Life	The following specifications shall be satisfied when the capacitors are restored to +25°C after exposing them for 1,000 hours at +85°C without voltage applied. The rated voltage shall be applied to the capacitors for a minimum of 30 minutes, at least 24 hours and not more than 48 hours before the measurements. Capacitance change: $\leq \pm 20\%$ of initial measured value Tan δ (DF) : $\leq 150\%$ of initial specified value Leakage current : \leq initial specified value																											
Custom Designs	Custom CV values per case size and termination type may be available upon request. Contact appropriate representative with specific requirements.																											

U92X Series

Diagram of Dimensions - Snap Mount

Snap Mount

VSN Snap-in $\varnothing 30$ and $\varnothing 35$ standard
VNN Snap-in $\varnothing 30$ and $\varnothing 35$ optional

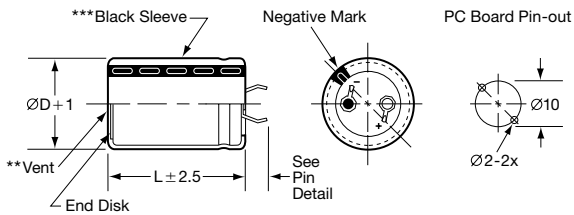

Snap Mount

Unit: mm

VND Snap-in $\varnothing 35$ and $\varnothing 40$ standard; $\varnothing 45$ optional
VSD Snap-in $\varnothing 35$ and $\varnothing 40$ optional

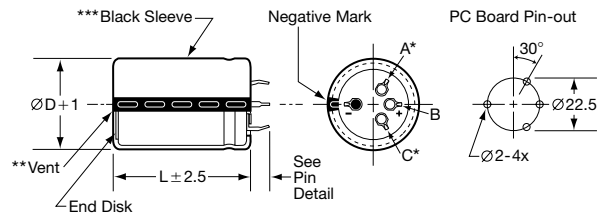

VEN Snap-in $\varnothing 30$ and $\varnothing 35$ optional

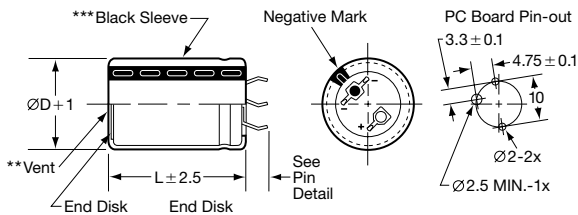

VNT Snap-in $\varnothing 45$ and $\varnothing 50$ standard

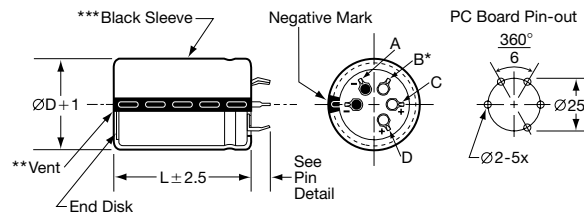

VS, VE & VN Snap-in Pin Dimensions

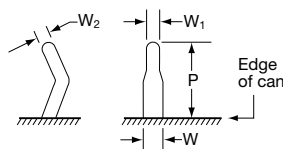

Type	P	W	W ₁	W ₂
VSN $\varnothing 30$	4.0 ± 0.5			
VSN $\varnothing 35$	3.5 ± 0.5			
VNN $\varnothing 30 - \varnothing 35$	5.8 ± 1.0			
VEN $\varnothing 30 - \varnothing 35$	4.0 ± 0.5	1.5 ± 0.2	0.8 ± 0.1	0.8 ± 0.1
VSD $\varnothing 35 - \varnothing 40$	3.5 ± 1.0			
VND $\varnothing 35 - \varnothing 45$	5.8 ± 1.0			
VNT $\varnothing 45 - \varnothing 50$	5.8 ± 1.0			

Straight Pin Mount

VQT Straight Standoff $\varnothing 40$, $\varnothing 45$ and $\varnothing 50$ optional

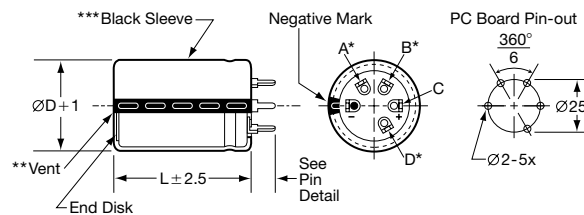

VQ Straight Standoff Pin Dimensions

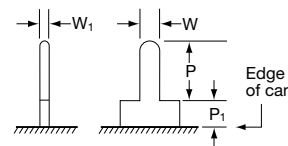

Type	P	P ₁	W	W ₁
Standoff Pin (VQ)	3.75 ± 1.0	2.0 max.	1.5 ± 0.1	0.7 ± 0.2

CAUTION:

* Use the blank terminals for mechanical support only. The blank terminals must not be connected to a solder trace on the PC board but be electrically isolated from the negative and positive terminals.

** The vent may be located either on the bottom or side of the can.

*** The black sleeve with gray stripe negative pin indicator is standard. Also note in some cases, the sleeve color may change slightly due to the operating conditions, however, the discoloration will not impair capacitor function.

U92X Series

Part Numbering System for U92X Series When ordering, always specify complete 18-field global part number.

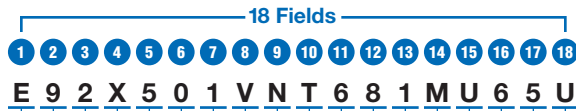

- 9 Supplement Code.** Field 18.
All construction options listed have Sn100% terminal plating.
U = PVC sleeve with PPE end disk.
M = PVC sleeve without end disk.
4 = UL746C compliant insulation for sleeve with end disk.
Other sleeve materials available as options upon request.
- 8 Case Size.** Fields 15, 16 and 17.
The single letter diameter code is inserted in field 15.
R = \varnothing 30mm
A = \varnothing 35mm
B = \varnothing 40mm
U = \varnothing 45mm
C = \varnothing 50mm
The double digit length code is inserted in fields 16 and 17.
40 = 40mm
50 = 50mm
65 = 65mm
80 = 80mm
A0 = 100mm
A5 = 105mm
- 7 Capacitance Tolerance.** Field 14.
M = \pm 20%
- 6 Capacitance.** Fields 11, 12 and 13.
Expressed in Microfarads. The first two digits are significant figures inserted in fields 11 and 12, and the third digit inserted in field 13 indicates the number of zeros for capacitance of 10 μ F or more. R indicates the decimal point for capacitance less than 10 μ F (e.g. 6R8 = 6.8 μ F; 680 = 68 μ F; 681 = 680 μ F; 682 = 6,800 μ F; 683 = 68,000 μ F).
- 5 Dummy Terminals.** Field 10.
N = No dummy terminals.
D = 2 dummy terminals.
T = 3 dummy terminals.
- 4 Terminal Type.** Fields 8 and 9.
VS = Snap-in pins, 4.0mm in length (\varnothing 30 VSN);
3.5mm in length (\varnothing 35 VSN, \varnothing 35 or \varnothing 40 VSD).
VN = Snap-in pins, 5.8mm in length.
VE = Snap-in pins, polarized, \varnothing 30 or \varnothing 35 option.
VQ = Straight standoff pins.
- 3 DC Rated Voltage.** Fields 5, 6 and 7.
Expressed in Volts. The first two digits are significant figures inserted in fields 5 and 6, and the third digit inserted in field 7 indicates the number of zeros for rated voltage of 10VDC or more. R indicates the decimal point for rated voltage less than 10VDC (e.g. 5R0 = 5.0VDC; 500 = 50VDC; 501 = 500VDC).
Rule Exception: Coding for rated voltage 385VDC = 3J1.
- 2 Series Name.** Fields 2, 3 and 4.
Enter the 3-letter/digit series name in fields 2, 3 and 4. If the series name is only 2 letters/digits, place a dash in field 4. For a series name with more than 3 letters/digits, refer to the individual series for the appropriate 3-field series name.
- 1 Capacitor Type.** Field 1.
Aluminum Electrolytic Capacitor (Polar).

U92X Series

Standard Voltage Ratings - Snap Mount

Rated Voltage (WVDC)	Capacitance (µF)	Global Part Number†	Nominal Case Size* D × L (mm)	Case Size Code	Maximum ESR (Ω) at +25°C, 120Hz	Rated Ripple Current (A rms) at +85°C, 120Hz
350 Volts 400 Volts Surge	330	E92X351VSN331MR40U	30 × 40	R40	0.302	2.1
	470	E92X351VSN471MR50U	30 × 50	R50	0.212	2.8
	680	E92X351VSN681MR65U	30 × 65	R65	0.146	3.7
	470	E92X351VSN471MA40U	35 × 40	A40	0.195	3.1
	680	E92X351VSN681MA50U	35 × 50	A50	0.135	4.2
	1,000	E92X351VSN102MA65U	35 × 65	A65	0.092	5.4
	1,200	E92X351VND122MA80U	35 × 80	A80	0.076	6.4
	1,500	E92X351VND152MAA0U	35 × 100	AA0	0.061	7.9
	820	E92X351VND821MB50U	40 × 50	B50	0.121	4.6
	1,200	E92X351VND122MB65U	40 × 65	B65	0.083	6.0
	1,500	E92X351VND152MB80U	40 × 80	B80	0.066	7.3
	1,800	E92X351VND182MBA0U	40 × 100	BA0	0.055	8.7
	1,000	E92X351VNT102MU50U	45 × 50	U50	0.107	5.2
	1,500	E92X351VNT152MU65U	45 × 65	U65	0.072	6.9
	1,800	E92X351VNT182MU80U	45 × 80	U80	0.060	8.2
	2,700	E92X351VNT272MUA5U	45 × 105	UA5	0.040	11.1
	1,200	E92X351VNT122MC50U	50 × 50	C50	0.103	5.4
	1,800	E92X351VNT182MC65U	50 × 65	C65	0.069	7.3
2,200	E92X351VNT222MC80U	50 × 80	C80	0.056	8.8	
3,300	E92X351VNT332MCA5U	50 × 105	CA5	0.037	12.2	
385 Volts 435 Volts Surge	270	E92X3J1VSN271MR40U	30 × 40	R40	0.339	2.0
	390	E92X3J1VSN391MR50U	30 × 50	R50	0.235	2.6
	560	E92X3J1VSN561MR65U	30 × 65	R65	0.164	3.5
	390	E92X3J1VSN391MA40U	35 × 40	A40	0.225	2.9
	560	E92X3J1VSN561MA50U	35 × 50	A50	0.156	3.9
	820	E92X3J1VSN821MA65U	35 × 65	A65	0.107	5.0
	1,000	E92X3J1VND102MA80U	35 × 80	A80	0.088	5.9
	1,200	E92X3J1VND122MAA0U	35 × 100	AA0	0.073	7.2
	680	E92X3J1VND681MB50U	40 × 50	B50	0.135	4.4
	1,000	E92X3J1VND102MB65U	40 × 65	B65	0.092	5.8
	1,200	E92X3J1VND122MB80U	40 × 80	B80	0.076	6.8
	1,800	E92X3J1VND182MBA0U	40 × 100	BA0	0.051	9.0
	1,000	E92X3J1VNT102MU50U	45 × 50	U50	0.100	5.4
	1,200	E92X3J1VNT122MU65U	45 × 65	U65	0.083	6.4
	1,500	E92X3J1VNT152MU80U	45 × 80	U80	0.066	7.7
	2,200	E92X3J1VNT222MUA5U	45 × 105	UA5	0.045	10.4
	1,200	E92X3J1VNT122MC50U	50 × 50	C50	0.096	5.7
	1,500	E92X3J1VNT152MC65U	50 × 65	C65	0.077	6.9
2,200	E92X3J1VNT222MC80U	50 × 80	C80	0.052	9.1	
2,700	E92X3J1VNT272MCA5U	50 × 105	CA5	0.043	11.4	
400 Volts 450 Volts Surge	270	E92X401VSN271MR40U	30 × 40	R40	0.339	2.0
	390	E92X401VSN391MR50U	30 × 50	R50	0.235	2.6
	470	E92X401VSN471MR65U	30 × 65	R65	0.195	3.2
	390	E92X401VSN391MA40U	35 × 40	A40	0.225	2.9
	560	E92X401VSN561MA50U	35 × 50	A50	0.156	3.9
	680	E92X401VSN681MA65U	35 × 65	A65	0.129	4.6
	1,000	E92X401VND102MA80U	35 × 80	A80	0.088	5.9
	1,200	E92X401VND122MAA0U	35 × 100	AA0	0.073	7.2
	680	E92X401VND681MB50U	40 × 50	B50	0.135	4.4
	1,000	E92X401VND102MB65U	40 × 65	B65	0.092	5.8
	1,200	E92X401VND122MB80U	40 × 80	B80	0.076	6.8
	1,500	E92X401VND152MBA0U	40 × 100	BA0	0.061	8.2
	820	E92X401VNT821MU50U	45 × 50	U50	0.121	4.9
	1,200	E92X401VNT122MU65U	45 × 65	U65	0.083	6.4

† For construction and terminal options, refer to the part numbering system for descriptions and codes.

* Refer to diagram of dimensions for detailed case size specifications.

U92X Series

Standard Voltage Ratings - Snap Mount

Rated Voltage (VWDC)	Capacitance (µF)	Global Part Number†	Nominal Case Size* D × L (mm)	Case Size Code	Maximum ESR (Ω) at +25°C, 120Hz	Rated Ripple Current (A rms) at +85°C, 120Hz
400 Volts 450 Volts Surge	1,500	E92X401VNT152MU80U	45 × 80	U80	0.066	7.7
	2,200	E92X401VNT222MJA5U	45 × 105	UA5	0.045	10.4
	1,200	E92X401VNT122MC50U	50 × 50	C50	0.093	5.6
	1,500	E92X401VNT152MC65U	50 × 65	C65	0.074	7.0
	1,800	E92X401VNT182MC80U	50 × 80	C80	0.062	8.4
	2,700	E92X401VNT272MCA5U	50 × 105	CA5	0.041	11.6
420 Volts 470 Volts Surge	220	E92X421VSN221MR40U	30 × 40	R40	0.389	1.9
	330	E92X421VSN331MR50U	30 × 50	R50	0.284	2.4
	470	E92X421VSN471MR65U	30 × 65	R65	0.202	3.2
	390	E92X421VSN391MA40U	35 × 40	A40	0.251	2.8
	470	E92X421VSN471MA50U	35 × 50	A50	0.183	3.6
	680	E92X421VSN681MA65U	35 × 65	A65	0.130	4.6
	820	E92X421VND821MA80U	35 × 80	A80	0.101	5.5
	1,200	E92X421VND122MAA0U	35 × 100	AA0	0.078	7.0
	680	E92X421VND681MB50U	40 × 50	B50	0.142	4.3
	820	E92X421VND821MB65U	40 × 65	B65	0.102	5.5
	1,200	E92X421VND122MB80U	40 × 80	B80	0.079	6.6
	1,500	E92X421VND152MBA0U	40 × 100	BA0	0.061	8.2
	820	E92X421VNT821MU50U	45 × 50	U50	0.124	4.8
	1,000	E92X421VNT102MU65U	45 × 65	U65	0.089	6.2
	1,200	E92X421VNT122MU80U	45 × 80	U80	0.069	7.6
	1,800	E92X421VNT182MJA5U	45 × 105	UA5	0.051	9.9
	1,000	E92X421VNT102MC50U	50 × 50	C50	0.109	5.2
	1,200	E92X421VNT122MC65U	50 × 65	C65	0.078	6.8
1,800	E92X421VNT182MC80U	50 × 80	C80	0.061	8.5	
2,200	E92X421VNT222MCA5U	50 × 105	CA5	0.044	11.2	
450 Volts 500 Volts Surge	220	E92X451VSN221MR40U	30 × 40	R40	0.411	1.8
	330	E92X451VSN331MR50U	30 × 50	R50	0.300	2.3
	390	E92X451VSN391MR65U	30 × 65	R65	0.213	3.1
	330	E92X451VSN331MA40U	35 × 40	A40	0.304	2.5
	470	E92X451VSN471MA50U	35 × 50	A50	0.193	3.5
	560	E92X451VSN561MA65U	35 × 65	A65	0.138	4.4
	820	E92X451VND821MA80U	35 × 80	A80	0.107	5.4
	1,000	E92X451VND102MAA0U	35 × 100	AA0	0.082	6.8
	560	E92X451VND561MB50U	40 × 50	B50	0.163	4.0
	820	E92X451VND821MB65U	40 × 65	B65	0.117	5.1
	1,000	E92X451VND102MB80U	40 × 80	B80	0.091	6.2
	1,200	E92X451VND122MBA0U	40 × 100	BA0	0.070	7.7
	680	E92X451VNT681MU50U	45 × 50	U50	0.137	4.6
	1,000	E92X451VNT102MU65U	45 × 65	U65	0.098	5.9
	1,200	E92X451VNT122MU80U	45 × 80	U80	0.076	7.2
	1,800	E92X451VNT182MJA5U	45 × 105	UA5	0.056	9.4
	820	E92X451VNT821MC50U	50 × 50	C50	0.115	5.1
	1,200	E92X451VNT122MC65U	50 × 65	C65	0.083	6.6
1,500	E92X451VNT152MC80U	50 × 80	C80	0.064	8.2	
2,200	E92X451VNT222MCA5U	50 × 105	CA5	0.047	10.8	
500 Volts 550 Volts Surge	150	E92X501VSN151MR40U	30 × 40	R40	0.557	1.6
	180	E92X501VSN181MR50U	30 × 50	R50	0.464	1.9
	270	E92X501VSN271MR65U	30 × 65	R65	0.310	2.6
	220	E92X501VSN221MA40U	35 × 40	A40	0.362	2.3
	270	E92X501VSN271MA50U	35 × 50	A50	0.295	2.8
	390	E92X501VSN391MA65U	35 × 65	A65	0.204	3.6

† For construction and terminal options, refer to the part numbering system for descriptions and codes.

* Refer to diagram of dimensions for detailed case size specifications.

U92X Series

Standard Voltage Ratings - Snap Mount

Rated Voltage (WVDC)	Capacitance (µF)	Global Part Number†	Nominal Case Size* D × L (mm)	Case Size Code	Maximum ESR (Ω) at +25°C, 120Hz	Rated Ripple Current (A rms) at +85°C, 120Hz
500 Volts 550 Volts Surge	560	E92X501VND561MA80U	35 × 80	A80	0.142	4.7
	680	E92X501VND681MAA0U	35 × 100	AA0	0.117	5.7
	390	E92X501VND391MB50U	40 × 50	B50	0.204	3.6
	560	E92X501VND561MB65U	40 × 65	B65	0.142	4.6
	680	E92X501VND681MB80U	40 × 80	B80	0.117	5.5
	820	E92X501VND821MBA0U	40 × 100	BA0	0.097	6.5
	560	E92X501VNT561MU50U	45 × 50	U50	0.156	4.3
	680	E92X501VNT681MU65U	45 × 65	U65	0.129	5.2
	1,000	E92X501VNT102MU80U	45 × 80	U80	0.088	6.7
	1,200	E92X501VNT122MUA5U	45 × 105	UA5	0.073	8.2
	680	E92X501VNT681MC50U	50 × 50	C50	0.141	4.6
	1,000	E92X501VNT102MC65U	50 × 65	C65	0.096	6.2
	1,200	E92X501VNT122MC80U	50 × 80	C80	0.080	7.4
	1,800	E92X501VNT182MCA5U	50 × 105	CA5	0.053	10.2

† For construction and terminal options, refer to the part numbering system for descriptions and codes.

* Refer to diagram of dimensions for detailed case size specifications.

U33D Series



- Large Can
- Screw Terminals
- High Ripple
- 25 to 550VDC Voltage Range
- High Capacitance
- RoHS Compliant
- +105°C Maximum Temperature
- 2,000 Hours Lifetime at +105°C

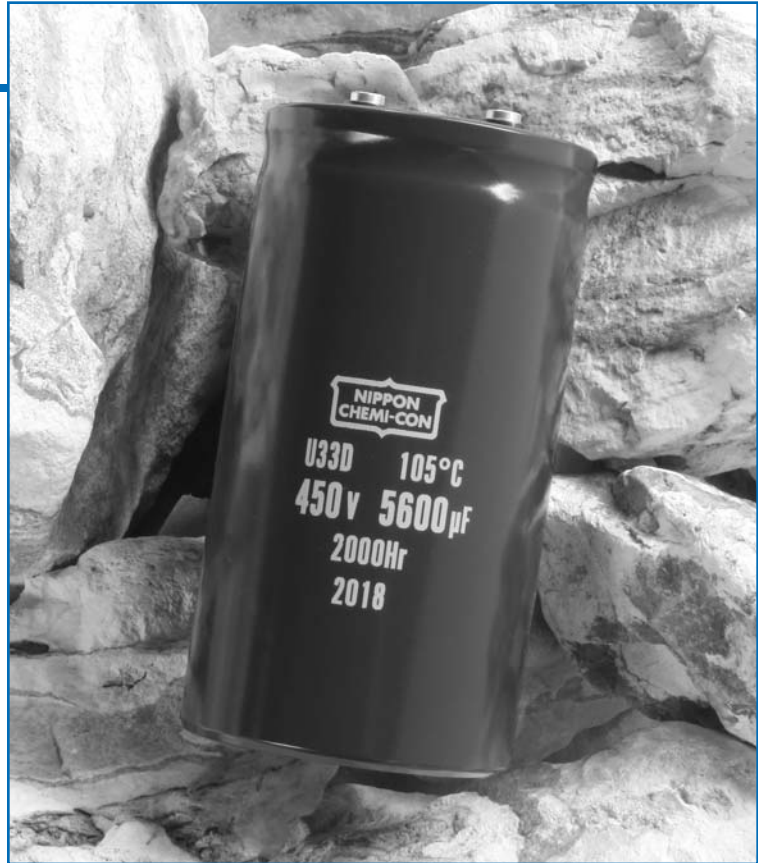

The U33D series is a high voltage screw mount series that is ideal for inverter applications requiring high ripple current capabilities. The U33D series has a wide voltage range of 25 to 550 volts and an endurance rating of 2,000 hours at +105°C with the rated ripple current applied. These capacitors are available with a variety of high current English or Metric thread terminals. Mounting options include a three-footed clamp or bottom threaded stud. Custom designs are available upon request.

Summary of Specifications

- Screw terminals: high and low post, English and Metric thread.
- Capacitance range: 560 to 1,000,000µF.
- Voltage range: 25 to 550VDC.
- Category temperature range: -40°C to +105°C.
- Leakage current: 0.02CV(µA) or 5mA, whichever is smaller, after 5 minutes at +25°C.
- Standard capacitance tolerance: ±20%
- Nominal case size (D×L): D = 50.8mm (2.000") to 89mm (3.500"); L = 79mm (3.125") to 219mm (8.625").
- Rated lifetime: 2,000 hours at +105°C with rated ripple current applied.

U33D Series

U33D Specifications - Screw Terminals

Item	Characteristics																																															
Category Temperature Range	- 40 to +105°C																																															
Rated Voltage Range	25 to 550VDC																																															
Capacitance Range	560 to 1,000,000 μ F at +25°C, 120Hz																																															
Capacitance Tolerance	\pm 20% (M) at +25°C, 120Hz																																															
Leakage Current	$I = 0.02CV$ (μ A) or 5mA, whichever is smaller, after 5 minutes at +25°C. Where I = Max. leakage current (μ A), C = Nominal capacitance (μ F) and V = Rated voltage (V)																																															
Rated Ripple Current Multipliers	<p>Ambient Temperature (°C)</p> <table border="1"> <thead> <tr> <th>$\leq +65^\circ\text{C}$</th> <th>+85°C</th> <th>+105°C</th> </tr> </thead> <tbody> <tr> <td>2.20</td> <td>1.73</td> <td>1.00</td> </tr> </tbody> </table> <p>Frequency (Hz)</p> <table border="1"> <thead> <tr> <th>DC Rated Voltage</th> <th>50Hz</th> <th>120Hz</th> <th>300Hz</th> <th>1kHz</th> <th>10kHz</th> <th>100kHz</th> </tr> </thead> <tbody> <tr> <td>25-550V</td> <td>0.70</td> <td>1.00</td> <td>1.16</td> <td>1.30</td> <td>1.41</td> <td>1.43</td> </tr> </tbody> </table>	$\leq +65^\circ\text{C}$	+85°C	+105°C	2.20	1.73	1.00	DC Rated Voltage	50Hz	120Hz	300Hz	1kHz	10kHz	100kHz	25-550V	0.70	1.00	1.16	1.30	1.41	1.43																											
$\leq +65^\circ\text{C}$	+85°C	+105°C																																														
2.20	1.73	1.00																																														
DC Rated Voltage	50Hz	120Hz	300Hz	1kHz	10kHz	100kHz																																										
25-550V	0.70	1.00	1.16	1.30	1.41	1.43																																										
Endurance (Load Life)	<p>The following specifications shall be satisfied when the capacitors are restored to +25°C after subjecting them to DC voltage for 2,000 hours at +105°C with the rated ripple current applied. The sum of the DC voltage and peak AC voltage must not exceed the full rated voltage of the capacitors.</p> <p>Capacitance change: \leq 20% from initial measurement ESR change : \leq 200% of initial specified limit Leakage current : \leq initial specified limit</p>																																															
Shelf Life	<p>The following specifications shall be satisfied when the capacitors are restored to +25°C after exposing them for 500 hours at +105°C without voltage applied. The rated voltage shall be applied to the capacitors for a minimum of 30 minutes, at least 24 hours and not more than 48 hours before the measurements.</p> <p>Capacitance change: \leq 20% from initial measurement ESR change : \leq 200% of initial specified limit Leakage current : \leq initial specified limit</p>																																															
Vibration Rating	10-55Hz, 10g sinusoidal in three axes, 2 hours per axis.																																															
Maximum Tightening Torque	<table border="1"> <thead> <tr> <th>Terminal Code</th> <th>HP</th> <th>HL</th> <th>CD</th> <th>CP</th> <th>CH</th> <th>CA</th> <th>CS</th> </tr> </thead> <tbody> <tr> <td>Thread Size</td> <td>10-32 NF-2B</td> <td>M5x0.8-6H</td> <td></td> <td>1/4-28 NF-2B</td> <td></td> <td>M6x1-6H</td> <td></td> </tr> <tr> <td>3 Threads Engaged</td> <td colspan="3">2.0 N·m (18.0 in·lb)</td> <td colspan="4">4.0 N·m (35.0 in·lb)</td> </tr> <tr> <td>6 Threads Engaged</td> <td colspan="3">2.8 N·m (25.0 in·lb)</td> <td colspan="4">6.2 N·m (55.0 in·lb)</td> </tr> </tbody> </table>	Terminal Code	HP	HL	CD	CP	CH	CA	CS	Thread Size	10-32 NF-2B	M5x0.8-6H		1/4-28 NF-2B		M6x1-6H		3 Threads Engaged	2.0 N·m (18.0 in·lb)			4.0 N·m (35.0 in·lb)				6 Threads Engaged	2.8 N·m (25.0 in·lb)			6.2 N·m (55.0 in·lb)																		
Terminal Code	HP	HL	CD	CP	CH	CA	CS																																									
Thread Size	10-32 NF-2B	M5x0.8-6H		1/4-28 NF-2B		M6x1-6H																																										
3 Threads Engaged	2.0 N·m (18.0 in·lb)			4.0 N·m (35.0 in·lb)																																												
6 Threads Engaged	2.8 N·m (25.0 in·lb)			6.2 N·m (55.0 in·lb)																																												
Typical Inductance (nH) at 1MHz	<table border="1"> <thead> <tr> <th rowspan="2">Case Diameter (mm)</th> <th colspan="7">Terminal Code</th> </tr> <tr> <th>HP</th> <th>HL</th> <th>CD</th> <th>CP</th> <th>CH</th> <th>CA</th> <th>CS</th> </tr> </thead> <tbody> <tr> <td>ϕ50.8</td> <td>—</td> <td>—</td> <td>NA</td> <td>NA</td> <td>NA</td> <td>NA</td> <td>NA</td> </tr> <tr> <td>ϕ63.5</td> <td>—</td> <td>—</td> <td>—</td> <td>—</td> <td>—</td> <td>—</td> <td>—</td> </tr> <tr> <td>ϕ76.2</td> <td>30</td> <td>30</td> <td>25</td> <td>20</td> <td>25</td> <td>20</td> <td>25</td> </tr> <tr> <td>ϕ89.0</td> <td>30</td> <td>30</td> <td>25</td> <td>20</td> <td>25</td> <td>20</td> <td>25</td> </tr> </tbody> </table>	Case Diameter (mm)	Terminal Code							HP	HL	CD	CP	CH	CA	CS	ϕ 50.8	—	—	NA	NA	NA	NA	NA	ϕ 63.5	—	—	—	—	—	—	—	ϕ 76.2	30	30	25	20	25	20	25	ϕ 89.0	30	30	25	20	25	20	25
Case Diameter (mm)	Terminal Code																																															
	HP	HL	CD	CP	CH	CA	CS																																									
ϕ 50.8	—	—	NA	NA	NA	NA	NA																																									
ϕ 63.5	—	—	—	—	—	—	—																																									
ϕ 76.2	30	30	25	20	25	20	25																																									
ϕ 89.0	30	30	25	20	25	20	25																																									
Custom Designs	Custom CV values per case size and termination type may be available upon request. Contact appropriate representative with specific requirements.																																															

U33D Series

Diagram of Dimensions - Screw Terminals

Large Can/Screw Terminals

Unit: mm (inches)

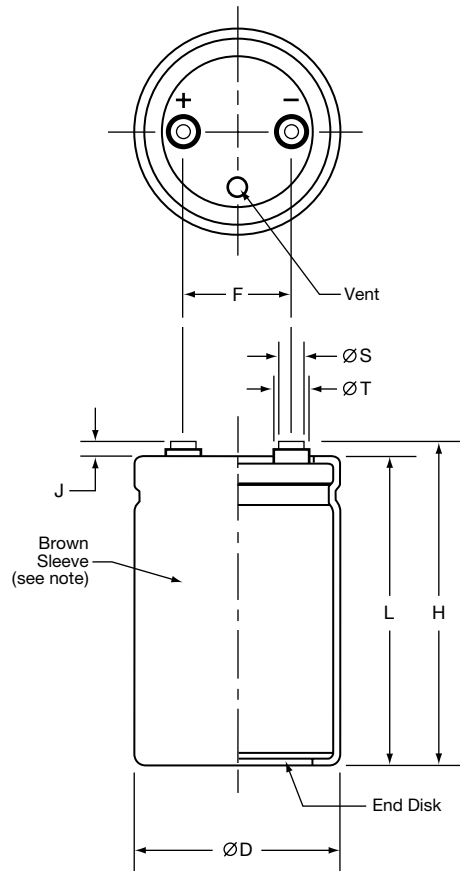

Case Dimensions and Standard Box Quantities

Case Size Code	ØD +2.0 (0.080)	L ±1.0 (0.040)	F ±0.25 (0.010)	Standard Box Quantity
C79 C92 CA5 CB7 CD0 CE3	50.8 (2.000)	79 (3.125)	22.2 (0.875)	49
		92 (3.625)		
		105 (4.125)		
		117 (4.625)		
		130 (5.125)		
		143 (5.625)		
D79 DA5 DB7 DD0 DE3	63.5 (2.500)	79 (3.125)	28.6 (1.125)	20
		105 (4.125)		
		117 (4.625)		
		130 (5.125)		
		143 (5.625)		
E92 EA5 EB7 ED0 EE3 EM9	76.2 (3.000)	92 (3.625)	31.8 (1.250)	16
		105 (4.125)		9
		117 (4.625)		
		130 (5.125)		
		143 (5.625)		
		219 (8.625)		
F92 FA5 FB7 FD0 FE3 FJ1 FM9	89.0 (3.500)	92 (3.625)	31.8 (1.250)	5
		105 (4.125)		
		117 (4.625)		
		130 (5.125)		
		143 (5.625)		
		181 (7.125)		
		219 (8.625)		

Note:
In some cases, the color of the sleeve may change slightly due to the operating conditions, however, the discoloration will not impair capacitor function.

Terminal Specifications

Terminal Code	Available Case Diameter		Thread Size	Minimum Thread Depth	J ±0.5 (0.020)	H ±2.0 (0.080)	ØS ±0.25 (0.010)	ØT ±0.25 (0.010)
	ØD Code	ØD mm (inches)						
HP	C	50.8 (2.000)	10-32 NF-2B	9.5 (0.375)	6.4 (0.250)	L+J	8.0 (0.313)	11.1 (0.438)
HL	C	50.8 (2.000)	M5x0.8-6H	9.5 (0.375)	6.4 (0.250)	L+J	8.0 (0.313)	11.1 (0.438)
CD	D-E	63.5 - 76.2 (2.500 - 3.000)	M5x0.8-6H	8.5 (0.335)	5.0 (0.200)	L+J	13.0 (0.512)	18.8 (0.740)
CP	D-F	63.5 - 89.0 (2.500 - 3.500)	1/4-28 NF-2B	8.7 (0.344)	2.4 (0.093)	L+J	17.5 (0.689)	—
CH	D-F	63.5 - 89.0 (2.500 - 3.500)	1/4-28 NF-2B	11.9 (0.468)	6.4 (0.250)	L+J	17.5 (0.689)	—
CA	D-F	63.5 - 89.0 (2.500 - 3.500)	M6x1-6H	8.7 (0.344)	2.4 (0.093)	L+J	17.5 (0.689)	—
CS	D-F	63.5 - 89.0 (2.500 - 3.500)	M6x1-6H	11.9 (0.468)	6.4 (0.250)	L+J	17.5 (0.689)	—

Mounting Hardware is optional. Refer to hardware specifications on the following page.

U33D
SCREW MOUNT 105°C

U33D Series

Mounting Hardware - Screw Terminals

Type C: Three-Footed Clamp

Unit: mm (inches)

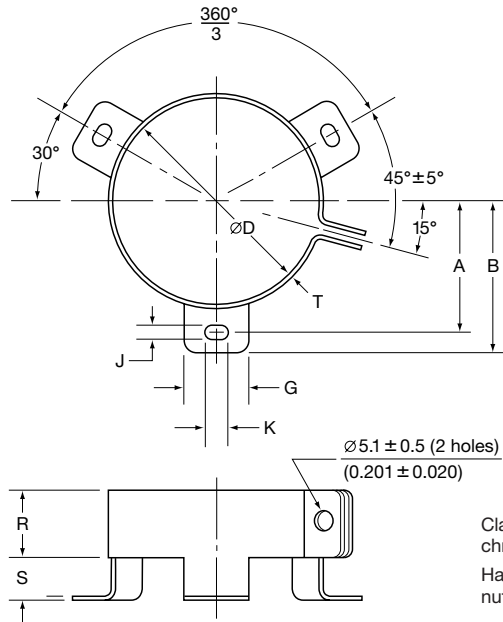

Clamp: Zinc with silver trivalent chromate post treatment.
Hardware: Screw, washer and hexagon nut included with each clamp.

Type C: Clamp Dimensions

Mounting Code	Case ØD	A ±1.0 (0.040)	B ±1.0 (0.040)	G ±1.0 (0.040)	J ±0.5 (0.020)	K ±0.5 (0.020)	R ±1.0 (0.040)	S ±1.0 (0.040)	T ±0.5 (0.020)
C	50.8 (2.000)	31.8 (1.250)	36.5 (1.437)	13.3 (0.524)	4.5 (0.177)	7.1 (0.280)	19.1 (0.751)	9.5 (0.374)	0.8 (0.032)
C	63.5 (2.500)	38.1 (1.500)	42.9 (1.689)	13.3 (0.524)	4.5 (0.177)	7.1 (0.280)	19.1 (0.751)	9.5 (0.374)	0.8 (0.032)
C	76.2 (3.000)	44.5 (1.750)	49.2 (1.937)	13.3 (0.524)	4.5 (0.177)	7.1 (0.280)	19.1 (0.751)	9.5 (0.374)	1.0 (0.040)
C	89.0 (3.500)	50.8 (2.000)	56.5 (2.224)	16.0 (0.630)	4.5 (0.177)	8.0 (0.313)	21.0 (0.827)	9.0 (0.354)	1.0 (0.040)

Type S: Stud Mounting

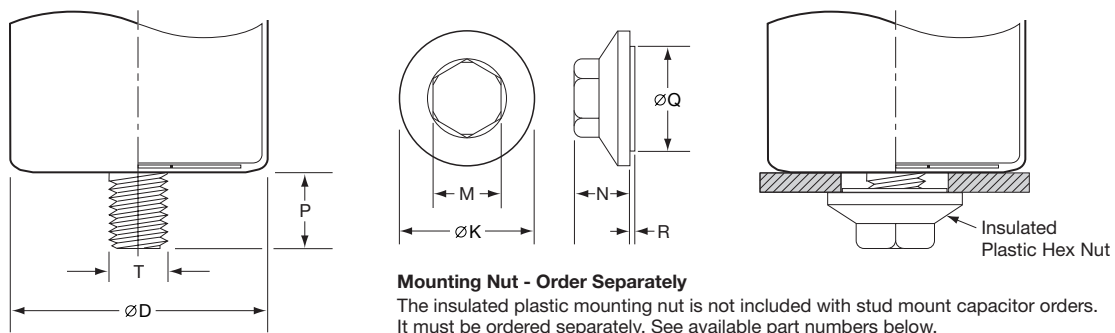

Mounting Nut - Order Separately

The insulated plastic mounting nut is not included with stud mount capacitor orders. It must be ordered separately. See available part numbers below.

Type S: Stud Dimensions

Mounting Code	P ±1.0 (0.040)	T Thread Size
S	16.0 (0.630)	M12

Mounting Nut Dimensions

Part Number	ØK ±2.0 (0.080)	M ±1.0 (0.040)	N ±1.0 (0.040)	ØQ ±1.0 (0.040)	R ±1.0 (0.040)
50-8D	30.0 (1.181)	19.0 (0.748)	18.0 (0.709)	22.0 (0.866)	1.40 (0.055)
50-8E	38.0 (1.496)	19.0 (0.748)	18.0 (0.709)	30.0 (1.181)	1.40 (0.055)

U33D Series

Part Numbering System for U33D Series When ordering, always specify complete 18-field global part number.

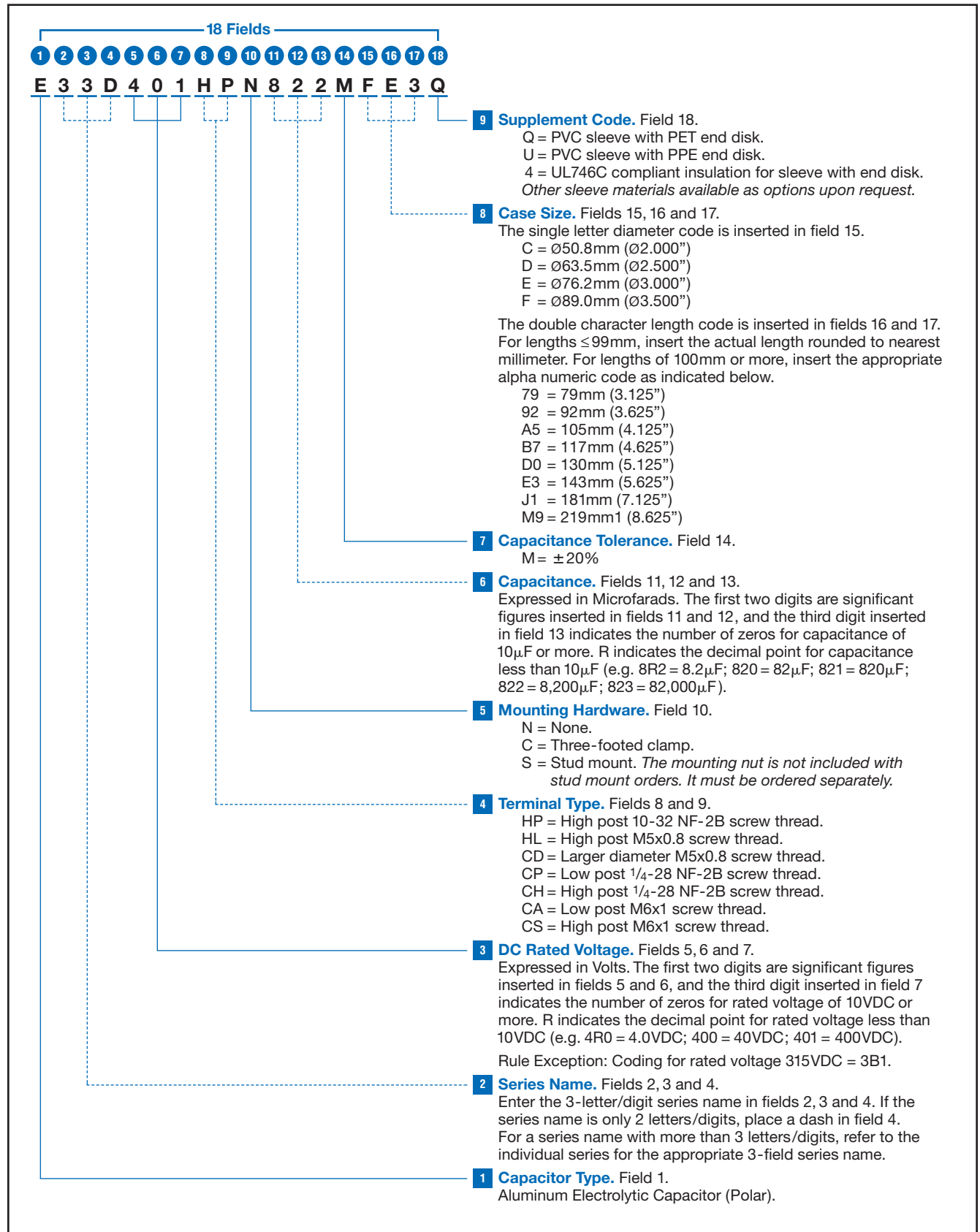

U33D Series

Standard Voltage Ratings - Screw Terminals

Rated Voltage (WVDC)	Capacitance (µF)	Global Part Number†	Nominal Case Size* D × L (mm)	Case Size Code	Maximum ESR (mΩ) at +25°C, 120Hz	Rated Ripple Current (A rms) at +105°C, 120Hz
25 Volts 32 Volts Surge	68,000	E33D250HPN683MC79Q	50.8 × 79	C79	19.7	11.2
	100,000	E33D250HPN104MC92Q	50.8 × 92	C92	13.4	14.3
	120,000	E33D250HPN124MCA5Q	50.8 × 105	CA5	11.2	16.4
	120,000	E33D250HPN124MCB7Q	50.8 × 117	CB7	11.2	17.1
	150,000	E33D250HPN154MCD0Q	50.8 × 130	CD0	8.9	19.8
	180,000	E33D250HPN184MCE3Q	50.8 × 143	CE3	7.4	22.4
	120,000	E33D250CPN124MD79Q	63.5 × 79	D79	13.7	15.1
	180,000	E33D250CPN184MDA5Q	63.5 × 105	DA5	9.1	20.3
	220,000	E33D250CPN224MDB7Q	63.5 × 117	DB7	7.5	23.3
	270,000	E33D250CPN274MDD0Q	63.5 × 130	DD0	6.1	27.0
	270,000	E33D250CPN274MDE3Q	63.5 × 143	DE3	6.1	27.8
	220,000	E33D250CPN224ME92Q	76.2 × 92	E92	7.6	23.7
	270,000	E33D250CPN274MEA5Q	76.2 × 105	EA5	6.2	27.4
	330,000	E33D250CPN334MEB7Q	76.2 × 117	EB7	5.1	31.3
	390,000	E33D250CPN394MED0Q	76.2 × 130	ED0	4.3	35.3
	390,000	E33D250CPN394MEE3Q	76.2 × 143	EE3	4.3	36.6
	680,000	E33D250CPN684MEM9Q	76.2 × 219	EM9	2.5	56.5
	330,000	E33D250CPN334MF92Q	89 × 92	F92	6.4	28.4
	390,000	E33D250CPN394MFA5Q	89 × 105	FA5	5.4	32.0
	470,000	E33D250CPN474MFB7Q	89 × 117	FB7	4.5	36.5
560,000	E33D250CPN564MFD0Q	89 × 130	FD0	3.8	41.5	
560,000	E33D250CPN564MFE3Q	89 × 143	FE3	3.9	41.7	
820,000	E33D250CPN824MFJ1Q	89 × 181	FJ1	2.7	55.7	
1,000,000	E33D250CPN105MFM9Q	89 × 219	FM9	2.4	62.5	
50 Volts 63 Volts Surge	27,000	E33D500HPN273MC79Q	50.8 × 79	C79	17.8	11.8
	39,000	E33D500HPN393MC92Q	50.8 × 92	C92	12.3	14.9
	47,000	E33D500HPN473MCA5Q	50.8 × 105	CA5	10.2	17.1
	47,000	E33D500HPN473MCB7Q	50.8 × 117	CB7	10.2	17.9
	56,000	E33D500HPN563MCD0Q	50.8 × 130	CD0	8.6	20.2
	68,000	E33D500HPN683MCE3Q	50.8 × 143	CE3	7.1	23.0
	47,000	E33D500CPN473MD79Q	63.5 × 79	D79	13.6	15.1
	82,000	E33D500CPN823MDA5Q	63.5 × 105	DA5	7.8	21.9
	82,000	E33D500CPN823MDB7Q	63.5 × 117	DB7	7.8	22.8
	100,000	E33D500CPN104MDD0Q	63.5 × 130	DD0	6.4	26.3
	120,000	E33D500CPN124MDE3Q	63.5 × 143	DE3	5.3	29.6
	100,000	E33D500CPN104ME92Q	76.2 × 92	E92	8.0	23.1
	120,000	E33D500CPN124MEA5Q	76.2 × 105	EA5	6.7	26.5
	120,000	E33D500CPN124MEB7Q	76.2 × 117	EB7	6.7	27.4
	150,000	E33D500CPN154MED0Q	76.2 × 130	ED0	5.3	31.7
	180,000	E33D500CPN184MEE3Q	76.2 × 143	EE3	4.4	36.0
	270,000	E33D500CPN274MEM9Q	76.2 × 219	EM9	3.0	51.6
	120,000	E33D500CPN124MF92Q	89 × 92	F92	7.3	26.6
	150,000	E33D500CPN154MFA5Q	89 × 105	FA5	5.9	30.8
	180,000	E33D500CPN184MFB7Q	89 × 117	FB7	4.9	35.0
220,000	E33D500CPN224MFD0Q	89 × 130	FD0	4.0	40.4	
220,000	E33D500CPN224MFE3Q	89 × 143	FE3	4.0	41.3	
330,000	E33D500CPN334MFJ1Q	89 × 181	FJ1	2.7	55.9	
390,000	E33D500CPN394MFM9Q	89 × 219	FM9	2.4	63.0	
63 Volts 79 Volts Surge	22,000	E33D630HPN223MC79Q	50.8 × 79	C79	16.4	12.3
	27,000	E33D630HPN273MC92Q	50.8 × 92	C92	13.3	14.3
	33,000	E33D630HPN333MCA5Q	50.8 × 105	CA5	10.9	16.6
	33,000	E33D630HPN333MCB7Q	50.8 × 117	CB7	10.9	17.3
	39,000	E33D630HPN393MCD0Q	50.8 × 130	CD0	9.2	19.4
	47,000	E33D630HPN473MCE3Q	50.8 × 143	CE3	7.7	22.1
	33,000	E33D630CPN333MD79Q	63.5 × 79	D79	14.5	14.7
	56,000	E33D630CPN563MDA5Q	63.5 × 105	DA5	8.6	20.9

†For terminal, mounting and construction options, refer to the part numbering system for descriptions and codes.

*Refer to diagram of dimensions for detailed case size specifications.

U33D Series

Standard Voltage Ratings - Screw Terminals

Rated Voltage (WVDC)	Capacitance (µF)	Global Part Number†	Nominal Case Size* D × L (mm)	Case Size Code	Maximum ESR (mΩ) at +25°C, 120Hz	Rated Ripple Current (A rms) at +105°C, 120Hz
63Volts 79Volts Surge	56,000	E33D630CPN563MDB7Q	63.5 × 117	DB7	8.6	21.7
	68,000	E33D630CPN683MDD0Q	63.5 × 130	DD0	7.1	25.0
	82,000	E33D630CPN823MDE3Q	63.5 × 143	DE3	5.9	28.3
	68,000	E33D630CPN683ME92Q	76.2 × 92	E92	8.8	22.0
	82,000	E33D630CPN823MEA5Q	76.2 × 105	EA5	7.3	25.3
	82,000	E33D630CPN823MEB7Q	76.2 × 117	EB7	7.3	26.1
	100,000	E33D630CPN104MED0Q	76.2 × 130	ED0	6.0	29.9
	120,000	E33D630CPN124MEE3Q	76.2 × 143	EE3	5.0	34.0
	180,000	E33D630CPN184MEM9Q	76.2 × 219	EM9	3.3	48.7
	82,000	E33D630CPN823MF92Q	89 × 92	F92	8.3	25.0
	100,000	E33D630CPN104MFA5Q	89 × 105	FA5	6.8	28.6
	120,000	E33D630CPN124MFB7Q	89 × 117	FB7	5.7	32.5
	150,000	E33D630CPN154MFD0Q	89 × 130	FD0	4.5	37.9
	150,000	E33D630CPN154MFE3Q	89 × 143	FE3	4.5	38.8
	220,000	E33D630CPN224MFJ1Q	89 × 181	FJ1	3.1	51.9
270,000	E33D630CPN274MFM9Q	89 × 219	FM9	2.5	61.0	
100 Volts 125 Volts Surge	8,200	E33D101HPN822MC79Q	50.8 × 79	C79	31.7	8.8
	12,000	E33D101HPN123MC92Q	50.8 × 92	C92	21.7	11.2
	15,000	E33D101HPN153MCA5Q	50.8 × 105	CA5	17.3	13.2
	15,000	E33D101HPN153MCB7Q	50.8 × 117	CB7	17.3	13.7
	18,000	E33D101HPN183MCD0Q	50.8 × 130	CD0	14.4	15.5
	22,000	E33D101HPN223MCE3Q	50.8 × 143	CE3	11.8	17.8
	15,000	E33D101CPN153MD79Q	63.5 × 79	D79	17.9	13.2
	22,000	E33D101CPN223MDA5Q	63.5 × 105	DA5	12.2	17.5
	27,000	E33D101CPN273MDB7Q	63.5 × 117	DB7	9.9	20.2
	33,000	E33D101CPN333MDD0Q	63.5 × 130	DD0	8.1	23.3
	33,000	E33D101CPN333MDE3Q	63.5 × 143	DE3	8.1	24.0
	27,000	E33D101CPN273ME92Q	76.2 × 92	E92	11.9	19.0
	33,000	E33D101CPN333MEA5Q	76.2 × 105	EA5	9.7	22.0
	39,000	E33D101CPN393MEB7Q	76.2 × 117	EB7	8.2	24.7
	47,000	E33D101CPN473MED0Q	76.2 × 130	ED0	6.8	28.1
	56,000	E33D101CPN563MEE3Q	76.2 × 143	EE3	5.7	31.8
	82,000	E33D101CPN823MEM9Q	76.2 × 219	EM9	3.9	45.0
	39,000	E33D101CPN393MF92Q	89 × 92	F92	10.3	22.5
	47,000	E33D101CPN473MFA5Q	89 × 105	FA5	8.5	25.5
	56,000	E33D101CPN563MFB7Q	89 × 117	FB7	7.1	29.0
68,000	E33D101CPN683MFD0Q	89 × 130	FD0	5.9	33.3	
68,000	E33D101CPN683MFE3Q	89 × 143	FE3	5.9	34.0	
100,000	E33D101CPN104MFJ1Q	89 × 181	FJ1	4.0	45.6	
120,000	E33D101CPN124MFM9Q	89 × 219	FM9	3.3	53.0	
200 Volts 250 Volts Surge	3,300	E33D201HPN332MC79Q	50.8 × 79	C79	40.0	7.8
	4,700	E33D201HPN472MC92Q	50.8 × 92	C92	28.1	9.9
	4,700	E33D201HPN472MCA5Q	50.8 × 105	CA5	28.1	10.3
	5,600	E33D201HPN562MCB7Q	50.8 × 117	CB7	23.6	11.8
	6,800	E33D201HPN682MCD0Q	50.8 × 130	CD0	19.4	13.4
	8,200	E33D201HPN822MCE3Q	50.8 × 143	CE3	16.1	15.3
	5,600	E33D201CPN562MD79Q	63.5 × 79	D79	26.4	10.9
	8,200	E33D201CPN822MDA5Q	63.5 × 105	DA5	18.0	14.4
	10,000	E33D201CPN103MDB7Q	63.5 × 117	DB7	14.8	16.6
	12,000	E33D201CPN123MDD0Q	63.5 × 130	DD0	12.3	18.9
	12,000	E33D201CPN123MDE3Q	63.5 × 143	DE3	12.3	19.5
	10,000	E33D201CPN103ME92Q	76.2 × 92	E92	18.4	15.3
	12,000	E33D201CPN123MEA5Q	76.2 × 105	EA5	15.3	17.5
	15,000	E33D201CPN153MEB7Q	76.2 × 117	EB7	12.3	20.2
	18,000	E33D201CPN183MED0Q	76.2 × 130	ED0	10.2	22.9
	18,000	E33D201CPN183MEE3Q	76.2 × 143	EE3	10.2	23.8
	33,000	E33D201CPN333MEM9Q	76.2 × 219	EM9	5.6	37.6

† For terminal, mounting and construction options, refer to the part numbering system for descriptions and codes.

* Refer to diagram of dimensions for detailed case size specifications.

U33D Series

Standard Voltage Ratings - Screw Terminals

Rated Voltage (WVDC)	Capacitance (µF)	Global Part Number†	Nominal Case Size* D × L (mm)	Case Size Code	Maximum ESR (mΩ) at +25°C, 120Hz	Rated Ripple Current (A rms) at +105°C, 120Hz
200 Volts 250 Volts Surge	15,000	E33D201CPN153MF92Q	89 × 92	F92	12.3	20.5
	18,000	E33D201CPN183MFA5Q	89 × 105	FA5	10.2	23.3
	22,000	E33D201CPN223MFB7Q	89 × 117	FB7	8.4	26.8
	22,000	E33D201CPN223MFD0Q	89 × 130	FD0	8.4	27.9
	27,000	E33D201CPN273MFE3Q	89 × 143	FE3	6.8	31.6
	39,000	E33D201CPN393MFJ1Q	89 × 181	FJ1	4.7	42.0
	47,000	E33D201CPN473MFM9Q	89 × 219	FM9	3.9	48.9
250 Volts 300 Volts Surge	2,200	E33D251HPN222MC79Q	50.8 × 79	C79	50.9	6.9
	2,700	E33D251HPN272MC92Q	50.8 × 92	C92	41.5	8.1
	3,300	E33D251HPN332MCA5Q	50.8 × 105	CA5	33.9	9.4
	3,900	E33D251HPN392MCB7Q	50.8 × 117	CB7	28.7	10.7
	4,700	E33D251HPN472MCD0Q	50.8 × 130	CD0	23.8	12.1
	4,700	E33D251HPN472MCE3Q	50.8 × 143	CE3	23.8	12.5
	3,900	E33D251CPN392MD79Q	63.5 × 79	D79	30.8	10.1
	5,600	E33D251CPN562MDA5Q	63.5 × 105	DA5	21.4	13.2
	6,800	E33D251CPN682MDB7Q	63.5 × 117	DB7	17.6	15.2
	6,800	E33D251CPN682MDD0Q	63.5 × 130	DD0	17.6	15.8
	8,200	E33D251CPN822MDE3Q	63.5 × 143	DE3	14.6	17.9
	6,800	E33D251CPN682ME92Q	76.2 × 92	E92	19.4	14.9
	8,200	E33D251CPN822MEA5Q	76.2 × 105	EA5	16.1	17.1
	10,000	E33D251CPN103MEB7Q	76.2 × 117	EB7	13.2	19.5
	12,000	E33D251CPN123MED0Q	76.2 × 130	ED0	11.0	22.1
	12,000	E33D251CPN123MEE3Q	76.2 × 143	EE3	11.0	22.9
	18,000	E33D251CPN183MEM9Q	76.2 × 219	EM9	8.2	31.0
	8,200	E33D251CPN822MF92Q	89 × 92	F92	13.7	19.5
	10,000	E33D251CPN103MFA5Q	89 × 105	FA5	11.2	22.3
	12,000	E33D251CPN123MFB7Q	89 × 117	FB7	9.3	25.4
15,000	E33D251CPN153MFD0Q	89 × 130	FD0	7.5	29.6	
18,000	E33D251CPN183MFE3Q	89 × 143	FE3	6.2	33.1	
22,000	E33D251CPN223MFJ1Q	89 × 181	FJ1	5.1	40.5	
27,000	E33D251CPN273MFM9Q	89 × 219	FM9	4.1	47.5	
315 Volts 365 Volts Surge	1,800	E33D3B1HPN182MC79Q	50.8 × 79	C79	55.6	6.7
	2,200	E33D3B1HPN222MC92Q	50.8 × 92	C92	45.5	7.7
	2,700	E33D3B1HPN272MCA5Q	50.8 × 105	CA5	37.0	9.0
	2,700	E33D3B1HPN272MCB7Q	50.8 × 117	CB7	37.0	9.4
	3,300	E33D3B1HPN332MCD0Q	50.8 × 130	CD0	30.3	10.7
	3,900	E33D3B1HPN392MCE3Q	50.8 × 143	CE3	25.6	12.1
	2,200	E33D3B1CPN222MD79Q	63.5 × 79	D79	47.3	8.1
	3,300	E33D3B1CPN332MDA5Q	63.5 × 105	DA5	31.5	10.9
	3,900	E33D3B1CPN392MDB7Q	63.5 × 117	DB7	26.7	12.3
	4,700	E33D3B1CPN472MDD0Q	63.5 × 130	DD0	22.1	14.1
	5,600	E33D3B1CPN562MDE3Q	63.5 × 143	DE3	18.6	15.9
	3,900	E33D3B1CPN392ME92Q	76.2 × 92	E92	28.7	12.2
	4,700	E33D3B1CPN472MEA5Q	76.2 × 105	EA5	23.8	14.0
	5,600	E33D3B1CPN562MEB7Q	76.2 × 117	EB7	20.0	15.8
	6,800	E33D3B1CPN682MED0Q	76.2 × 130	ED0	16.5	18.0
	8,200	E33D3B1CPN822MEE3Q	76.2 × 143	EE3	13.7	20.6
	15,000	E33D3B1CPN153MEM9Q	76.2 × 219	EM9	7.5	32.5
	6,800	E33D3B1CPN682MF92Q	89 × 92	F92	16.5	17.7
	8,200	E33D3B1CPN822MFA5Q	89 × 105	FA5	13.7	20.2
	8,200	E33D3B1CPN822MFB7Q	89 × 117	FB7	13.7	21.0
10,000	E33D3B1CPN103MFD0Q	89 × 130	FD0	11.2	24.1	
12,000	E33D3B1CPN123MFE3Q	89 × 143	FE3	9.3	27.0	
15,000	E33D3B1CPN153MFJ1Q	89 × 181	FJ1	7.5	33.4	
18,000	E33D3B1CPN183MFM9Q	89 × 219	FM9	6.2	38.8	

† For terminal, mounting and construction options, refer to the part numbering system for descriptions and codes.

* Refer to diagram of dimensions for detailed case size specifications.

U33D Series

Standard Voltage Ratings - Screw Terminals

Rated Voltage (WVDC)	Capacitance (µF)	Global Part Number†	Nominal Case Size* D × L (mm)	Case Size Code	Maximum ESR (mΩ) at +25°C, 120Hz	Rated Ripple Current (A rms) at +105°C, 120Hz
350 Volts 400 Volts Surge	1,500	E33D351HPN152MC79Q	50.8 × 79	C79	64.0	6.2
	1,800	E33D351HPN182MC92Q	50.8 × 92	C92	53.3	7.2
	2,200	E33D351HPN222MCA5Q	50.8 × 105	CA5	43.6	8.3
	2,700	E33D351HPN272MCB7Q	50.8 × 117	CB7	35.6	9.6
	3,300	E33D351HPN332MCD0Q	50.8 × 130	CD0	29.1	11.0
	3,300	E33D351HPN332MCE3Q	50.8 × 143	CE3	29.1	11.4
	2,200	E33D351CPN222MD79Q	63.5 × 79	D79	45.5	8.3
	3,300	E33D351CPN332MDA5Q	63.5 × 105	DA5	30.3	11.1
	3,900	E33D351CPN392MDB7Q	63.5 × 117	DB7	25.6	12.6
	4,700	E33D351CPN472MDD0Q	63.5 × 130	DD0	21.3	14.4
	5,600	E33D351CPN562MDE3Q	63.5 × 143	DE3	17.9	16.2
	3,900	E33D351CPN392ME92Q	76.2 × 92	E92	27.7	12.4
	4,700	E33D351CPN472MEA5Q	76.2 × 105	EA5	23.0	14.3
	5,600	E33D351CPN562MEB7Q	76.2 × 117	EB7	19.3	16.1
	6,800	E33D351CPN682MED0Q	76.2 × 130	ED0	15.9	18.4
	8,200	E33D351CPN822MEE3Q	76.2 × 143	EE3	13.2	20.9
	12,000	E33D351CPN123MEM9Q	76.2 × 219	EM9	9.0	29.6
	5,600	E33D351CPN562MF92Q	89 × 92	F92	20.0	16.1
	6,800	E33D351CPN682MFA5Q	89 × 105	FA5	16.5	18.4
	8,600	E33D351CPN862MFB7Q	89 × 117	FB7	13.0	21.5
10,000	E33D351CPN103MFD0Q	89 × 130	FD0	11.2	24.1	
10,000	E33D351CPN103MFE3Q	89 × 143	FE3	11.2	24.7	
15,000	E33D351CPN153MFJ1Q	89 × 181	FJ1	7.5	33.4	
18,000	E33D351CPN183MFM9Q	89 × 219	FM9	6.2	38.8	
400 Volts 450 Volts Surge	1,200	E33D401HPN122MC79Q	50.8 × 79	C79	80.0	5.5
	1,500	E33D401HPN152MC92Q	50.8 × 92	C92	64.0	6.5
	1,800	E33D401HPN182MCA5Q	50.8 × 105	CA5	53.3	7.5
	2,200	E33D401HPN222MCB7Q	50.8 × 117	CB7	43.6	8.6
	2,700	E33D401HPN272MCD0Q	50.8 × 130	CD0	35.6	9.9
	2,700	E33D401HPN272MCE3Q	50.8 × 143	CE3	35.6	10.3
	1,800	E33D401CPN182MD79Q	63.5 × 79	D79	55.6	7.5
	2,700	E33D401CPN272MDA5Q	63.5 × 105	DA5	37.0	10.1
	3,300	E33D401CPN332MDB7Q	63.5 × 117	DB7	30.3	11.6
	3,900	E33D401CPN392MDD0Q	63.5 × 130	DD0	25.6	13.1
	4,700	E33D401CPN472MDE3Q	63.5 × 143	DE3	21.3	14.8
	3,300	E33D401CPN332ME92Q	76.2 × 92	E92	32.7	11.4
	3,900	E33D401CPN392MEA5Q	76.2 × 105	EA5	27.7	13.0
	4,700	E33D401CPN472MEB7Q	76.2 × 117	EB7	23.0	14.8
	5,600	E33D401CPN562MED0Q	76.2 × 130	ED0	19.3	16.7
	6,800	E33D401CPN682MEE3Q	76.2 × 143	EE3	15.9	19.1
	12,000	E33D401CPN123MEM9Q	76.2 × 219	EM9	9.0	29.6
	4,700	E33D401CPN472MF92Q	89 × 92	F92	23.8	14.7
	5,600	E33D401CPN562MFA5Q	89 × 105	FA5	20.0	16.7
	6,800	E33D401CPN682MFB7Q	89 × 117	FB7	16.5	19.1
8,200	E33D401CPN822MFD0Q	89 × 130	FD0	13.7	21.9	
8,200	E33D401CPN822MFE3Q	89 × 143	FE3	13.7	22.3	
12,000	E33D401CPN123MFJ1Q	89 × 181	FJ1	9.3	29.9	
15,000	E33D401CPN153MFM9Q	89 × 219	FM9	7.5	35.4	
450 Volts 500 Volts Surge	1,000	E33D451HPN102MC79Q	50.8 × 79	C79	96.0	5.1
	1,200	E33D451HPN122MC92Q	50.8 × 92	C92	80.0	5.8
	1,500	E33D451HPN152MCA5Q	50.8 × 105	CA5	64.0	6.8
	1,800	E33D451HPN182MCB7Q	50.8 × 117	CB7	53.3	7.8
	2,200	E33D451HPN222MCD0Q	50.8 × 130	CD0	43.6	8.9
	2,700	E33D451HPN272MCE3Q	50.8 × 143	CE3	35.6	10.3
	1,500	E33D451CPN152MD79Q	63.5 × 79	D79	64.0	7.0
	2,700	E33D451CPN272MDA5Q	63.5 × 105	DA5	35.6	10.3

† For terminal, mounting and construction options, refer to the part numbering system for descriptions and codes.

* Refer to diagram of dimensions for detailed case size specifications.

U33D Series

Standard Voltage Ratings - Screw Terminals

Rated Voltage (WVDC)	Capacitance (µF)	Global Part Number†	Nominal Case Size* D × L (mm)	Case Size Code	Maximum ESR (mΩ) at +25°C, 120Hz	Rated Ripple Current (A rms) at +105°C, 120Hz
450 Volts 500 Volts Surge	2,700	E33D451CPN272MDB7Q	63.5 × 117	DB7	35.6	10.7
	3,300	E33D451CPN332MDD0Q	63.5 × 130	DD0	29.1	12.3
	3,900	E33D451CPN392MDE3Q	63.5 × 143	DE3	24.6	13.8
	3,300	E33D451CPN332ME92Q	76.2 × 92	E92	31.5	11.7
	3,900	E33D451CPN392MEA5Q	76.2 × 105	EA5	26.7	13.3
	3,900	E33D451CPN392MEB7Q	76.2 × 117	EB7	26.7	13.7
	4,700	E33D451CPN472MED0Q	76.2 × 130	ED0	22.1	15.6
	5,600	E33D451CPN562MEE3Q	76.2 × 143	EE3	18.6	17.6
	10,000	E33D451CPN103MEM9Q	76.2 × 219	EM9	10.4	27.6
	3,900	E33D451CPN392MF92Q	89 × 92	F92	28.7	13.4
	4,700	E33D451CPN472MFA5Q	89 × 105	FA5	23.8	15.3
	5,600	E33D451CPN562MFB7Q	89 × 117	FB7	20.0	17.3
	6,800	E33D451CPN682MFD0Q	89 × 130	FD0	16.5	19.9
	8,200	E33D451CPN822MFE3Q	89 × 143	FE3	13.7	22.3
	10,000	E33D451CPN103MFJ1Q	89 × 181	FJ1	11.2	27.3
12,000	E33D451CPN123MFM9Q	89 × 219	FM9	9.3	31.7	
500 Volts 550 Volts Surge	680	E33D501HPN681MC79Q	50.8 × 79	C79	129.4	4.4
	820	E33D501HPN821MC92Q	50.8 × 92	C92	107.3	5.0
	1,000	E33D501HPN102MCA5Q	50.8 × 105	CA5	88.0	5.8
	1,200	E33D501HPN122MCB7Q	50.8 × 117	CB7	73.3	6.7
	1,500	E33D501HPN152MCD0Q	50.8 × 130	CD0	58.7	7.7
	1,500	E33D501HPN152MCE3Q	50.8 × 143	CE3	58.7	8.0
	1,200	E33D501CPN122MD79Q	63.5 × 79	D79	76.7	6.4
	1,800	E33D501CPN182MDA5Q	63.5 × 105	DA5	51.1	8.6
	2,200	E33D501CPN222MDB7Q	63.5 × 117	DB7	41.8	9.8
	2,200	E33D501CPN222MDD0Q	63.5 × 130	DD0	41.8	10.3
	2,700	E33D501CPN272MDE3Q	63.5 × 143	DE3	34.1	11.7
	2,200	E33D501CPN222ME92Q	76.2 × 92	E92	45.5	9.7
	2,700	E33D501CPN272MEA5Q	76.2 × 105	EA5	37.0	11.3
	2,700	E33D501CPN272MEB7Q	76.2 × 117	EB7	37.0	11.6
	3,300	E33D501CPN332MED0Q	76.2 × 130	ED0	30.3	13.3
	3,900	E33D501CPN392MEE3Q	76.2 × 143	EE3	25.6	15.0
	6,800	E33D501CPN682MEM9Q	76.2 × 219	EM9	14.7	23.2
	3,300	E33D501CPN332MF92Q	89 × 92	F92	31.5	12.8
	3,900	E33D501CPN392MFA5Q	89 × 105	FA5	26.7	14.4
	3,900	E33D501CPN392MFB7Q	89 × 117	FB7	26.7	15.0
	4,700	E33D501CPN472MFD0Q	89 × 130	FD0	22.1	17.2
5,600	E33D501CPN562MFE3Q	89 × 143	FE3	18.6	19.2	
6,800	E33D501CPN682MFJ1Q	89 × 181	FJ1	15.3	23.3	
10,000	E33D501CPN103MFM9Q	89 × 219	FM9	10.4	30.0	
550 Volts 600 Volts Surge	560	E33D551HPN561MC79Q	50.8 × 79	C79	157.1	4.0
	680	E33D551HPN681MC92Q	50.8 × 92	C92	129.4	4.6
	820	E33D551HPN821MCA5Q	50.8 × 105	CA5	107.3	5.3
	1,000	E33D551HPN102MCB7Q	50.8 × 117	CB7	88.0	6.1
	1,200	E33D551HPN122MCD0Q	50.8 × 130	CD0	73.3	6.9
	1,200	E33D551HPN122MCE3Q	50.8 × 143	CE3	73.3	7.2
	1,000	E33D551CPN102MD79Q	63.5 × 79	D79	92.0	5.8
	1,500	E33D551CPN152MDA5Q	63.5 × 105	DA5	61.3	7.8
	1,800	E33D551CPN182MDB7Q	63.5 × 117	DB7	51.1	8.9
	1,800	E33D551CPN182MDD0Q	63.5 × 130	DD0	51.1	9.3
	2,200	E33D551CPN222MDE3Q	63.5 × 143	DE3	41.8	10.6
	1,800	E33D551CPN182ME92Q	76.2 × 92	E92	55.6	8.8
	2,200	E33D551CPN222MEA5Q	76.2 × 105	EA5	45.5	10.2
	2,200	E33D551CPN222MEB7Q	76.2 × 117	EB7	45.5	10.5
	2,700	E33D551CPN272MED0Q	76.2 × 130	ED0	37.0	12.0
	3,300	E33D551CPN332MEE3Q	76.2 × 143	EE3	30.3	13.8
	5,600	E33D551CPN562MEM9Q	76.2 × 219	EM9	17.9	21.0

† For terminal, mounting and construction options, refer to the part numbering system for descriptions and codes.

* Refer to diagram of dimensions for detailed case size specifications.

U33D Series

Standard Voltage Ratings - Screw Terminals

Rated Voltage (WVDC)	Capacitance (μF)	Global Part Number†	Nominal Case Size* D × L (mm)	Case Size Code	Maximum ESR (mΩ) at +25°C, 120Hz	Rated Ripple Current (A rms) at +105°C, 120Hz
550 Volts 600 Volts Surge	2,200	E33D551CPN222MF92Q	89 × 92	F92	47.3	10.5
	2,700	E33D551CPN272MFA5Q	89 × 105	FA5	38.5	12.0
	3,300	E33D551CPN332MFB7Q	89 × 117	FB7	31.5	13.8
	3,900	E33D551CPN392MFD0Q	89 × 130	FD0	26.7	15.6
	4,700	E33D551CPN472MFE3Q	89 × 143	FE3	22.1	17.6
	5,600	E33D551CPN562MFJ1Q	89 × 181	FJ1	18.6	21.2
	8,200	E33D551CPN822MFM9Q	89 × 219	FM9	12.7	27.2

† For terminal, mounting and construction options, refer to the part numbering system for descriptions and codes.

* Refer to diagram of dimensions for detailed case size specifications.

U37D Series



- Large Can
- Screw Terminals
- High Ripple
- 350 to 550VDC Voltage Range
- High Capacitance
- RoHS Compliant
- +85°C Maximum Temperature
- 2,000 Hours Lifetime at +85°C



The U37D series is a high voltage screw mount series that is ideal for inverter applications requiring high ripple current capabilities. The U37D series has a voltage range of 350 to 550 volts and an endurance rating of 2,000 hours at +85°C with the rated ripple current applied. These capacitors are available with a variety of high current English or Metric thread terminals. Mounting options include a three-footed clamp or bottom threaded stud. Custom designs are available upon request.

Summary of Specifications

- Screw terminals: high and low post, English and Metric thread.
- Capacitance range: 1,000 to 22,000µF.
- Voltage range: 350 to 550VDC.
- Category temperature range: -40°C to +85°C.
- Leakage current: 0.02CV(µA) or 5mA, whichever is smaller, after 5 minutes at +25°C.
- Standard capacitance tolerance: ±20%
- Nominal case size (D×L): D = 50.8mm (2.000") to 89mm (3.500"); L = 79mm (3.125") to 219mm (8.625").
- Rated lifetime: 2,000 hours at +85°C with rated ripple current applied.

U37D Series

U37D Specifications - Screw Terminals

Item	Characteristics																																															
Category Temperature Range	- 40 to +85°C																																															
Rated Voltage Range	350 to 550VDC																																															
Capacitance Range	1,000 to 22,000µF at +25°C, 120Hz																																															
Capacitance Tolerance	± 20% (M) at +25°C, 120Hz																																															
Leakage Current	I = 0.02CV (µA) or 5mA, whichever is smaller, after 5 minutes at +25°C. Where I = Max. leakage current (µA), C = Nominal capacitance (µF) and V = Rated voltage (V)																																															
Rated Ripple Current Multipliers	<p>Ambient Temperature (°C)</p> <table border="1"> <tr> <td>≤ +45°C</td> <td>+65°C</td> <td>+85°C</td> </tr> <tr> <td>2.82</td> <td>1.73</td> <td>1.00</td> </tr> </table> <p>Frequency (Hz)</p> <table border="1"> <tr> <td>DC Rated Voltage</td> <td>50Hz</td> <td>120Hz</td> <td>300Hz</td> <td>1kHz</td> <td>10kHz</td> <td>100kHz</td> </tr> <tr> <td>350-550V</td> <td>0.30</td> <td>1.00</td> <td>1.20</td> <td>1.30</td> <td>1.40</td> <td>1.41</td> </tr> </table>	≤ +45°C	+65°C	+85°C	2.82	1.73	1.00	DC Rated Voltage	50Hz	120Hz	300Hz	1kHz	10kHz	100kHz	350-550V	0.30	1.00	1.20	1.30	1.40	1.41																											
≤ +45°C	+65°C	+85°C																																														
2.82	1.73	1.00																																														
DC Rated Voltage	50Hz	120Hz	300Hz	1kHz	10kHz	100kHz																																										
350-550V	0.30	1.00	1.20	1.30	1.40	1.41																																										
Endurance (Load Life)	<p>The following specifications shall be satisfied when the capacitors are restored to +25°C after subjecting them to DC voltage for 2,000 hours at +85°C with the rated ripple current applied. The sum of the DC voltage and peak AC voltage must not exceed the full rated voltage of the capacitors.</p> <p>Capacitance change: ≤ 20% from initial measurement ESR change : ≤ 200% of initial specified limit Leakage current : ≤ initial specified limit</p>																																															
Shelf Life	<p>The following specifications shall be satisfied when the capacitors are restored to +25°C after exposing them for 500 hours at +85°C without voltage applied. The rated voltage shall be applied to the capacitors for a minimum of 30 minutes, at least 24 hours and not more than 48 hours before the measurements.</p> <p>Capacitance change: ≤ 20% from initial measurement ESR change : ≤ 200% of initial specified limit Leakage current : ≤ initial specified limit</p>																																															
Vibration Rating	10-55Hz, 10g sinusoidal in three axes, 2 hours per axis.																																															
Maximum Tightening Torque	<table border="1"> <tr> <td>Terminal Code</td> <td>HP</td> <td>HL</td> <td>CD</td> <td>CP</td> <td>CH</td> <td>CA</td> <td>CS</td> </tr> <tr> <td>Thread Size</td> <td>10-32 NF-2B</td> <td>M5x0.8-6H</td> <td></td> <td>¼-28 NF-2B</td> <td></td> <td>M6x1-6H</td> <td></td> </tr> <tr> <td>3 Threads Engaged</td> <td colspan="3">2.0 N·m (18.0 in·lb)</td> <td colspan="4">4.0 N·m (35.0 in·lb)</td> </tr> <tr> <td>6 Threads Engaged</td> <td colspan="3">2.8 N·m (25.0 in·lb)</td> <td colspan="4">6.2 N·m (55.0 in·lb)</td> </tr> </table>	Terminal Code	HP	HL	CD	CP	CH	CA	CS	Thread Size	10-32 NF-2B	M5x0.8-6H		¼-28 NF-2B		M6x1-6H		3 Threads Engaged	2.0 N·m (18.0 in·lb)			4.0 N·m (35.0 in·lb)				6 Threads Engaged	2.8 N·m (25.0 in·lb)			6.2 N·m (55.0 in·lb)																		
Terminal Code	HP	HL	CD	CP	CH	CA	CS																																									
Thread Size	10-32 NF-2B	M5x0.8-6H		¼-28 NF-2B		M6x1-6H																																										
3 Threads Engaged	2.0 N·m (18.0 in·lb)			4.0 N·m (35.0 in·lb)																																												
6 Threads Engaged	2.8 N·m (25.0 in·lb)			6.2 N·m (55.0 in·lb)																																												
Typical Inductance (nH) at 1MHz	<table border="1"> <tr> <td rowspan="2">Case Diameter (mm)</td> <td colspan="7">Terminal Code</td> </tr> <tr> <td>HP</td> <td>HL</td> <td>CD</td> <td>CP</td> <td>CH</td> <td>CA</td> <td>CS</td> </tr> <tr> <td>Ø50.8</td> <td>—</td> <td>—</td> <td>NA</td> <td>NA</td> <td>NA</td> <td>NA</td> <td>NA</td> </tr> <tr> <td>Ø63.5</td> <td>—</td> <td>—</td> <td>—</td> <td>—</td> <td>—</td> <td>—</td> <td>—</td> </tr> <tr> <td>Ø76.2</td> <td>30</td> <td>30</td> <td>25</td> <td>20</td> <td>25</td> <td>20</td> <td>25</td> </tr> <tr> <td>Ø89.0</td> <td>30</td> <td>30</td> <td>25</td> <td>20</td> <td>25</td> <td>20</td> <td>25</td> </tr> </table>	Case Diameter (mm)	Terminal Code							HP	HL	CD	CP	CH	CA	CS	Ø50.8	—	—	NA	NA	NA	NA	NA	Ø63.5	—	—	—	—	—	—	—	Ø76.2	30	30	25	20	25	20	25	Ø89.0	30	30	25	20	25	20	25
Case Diameter (mm)	Terminal Code																																															
	HP	HL	CD	CP	CH	CA	CS																																									
Ø50.8	—	—	NA	NA	NA	NA	NA																																									
Ø63.5	—	—	—	—	—	—	—																																									
Ø76.2	30	30	25	20	25	20	25																																									
Ø89.0	30	30	25	20	25	20	25																																									
Custom Designs	Custom CV values per case size and termination type may be available upon request. Contact appropriate representative with specific requirements.																																															

U37D Series

Diagram of Dimensions - Screw Terminals

Large Can/Screw Terminals

Unit: mm (inches)

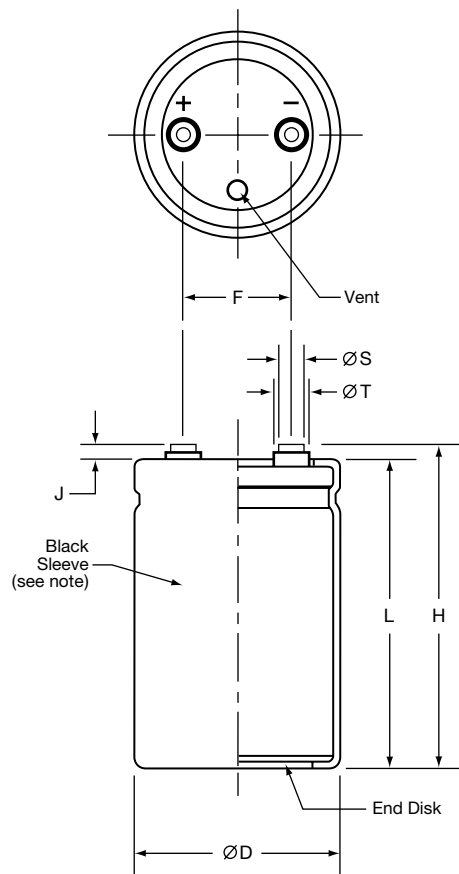

Case Dimensions and Standard Box Quantities

Case Size Code	ØD +2.0 (0.080)	L ±1.0 (0.040)	F ±0.25 (0.010)	Standard Box Quantity
C79	50.8 (2.000)	79 (3.125)	22.2 (0.875)	49
C92		92 (3.625)		
CA5		105 (4.125)		
CB7		117 (4.625)		
CD0		130 (5.125)		
CE3	143 (5.625)			
D79	63.5 (2.500)	79 (3.125)	28.6 (1.125)	20
DA5		105 (4.125)		
DB7		117 (4.625)		
DD0		130 (5.125)		
DE3		143 (5.625)		
E92	76.2 (3.000)	92 (3.625)	31.8 (1.250)	16
EA5		105 (4.125)		
EB7		117 (4.625)		
ED0		130 (5.125)		
EE3		143 (5.625)		
EM9	219 (8.625)	9		
F92	89.0 (3.500)	92 (3.625)	31.8 (1.250)	5
FA5		105 (4.125)		
FB7		117 (4.625)		
FD0		130 (5.125)		
FE3		143 (5.625)		
FJ1		181 (7.125)		
FM9	219 (8.625)			

Note:
In some cases, the color of the sleeve may change slightly due to the operating conditions, however, the discoloration will not impair capacitor function.

Terminal Specifications

Terminal Code	Available Case Diameter		Thread Size	Minimum Thread Depth	J ±0.5 (0.020)	H ±2.0 (0.080)	ØS ±0.25 (0.010)	ØT ±0.25 (0.010)
	ØD Code	ØD mm (inches)						
HP	C	50.8 (2.000)	10-32 NF-2B	9.5 (0.375)	6.4 (0.250)	L+J	8.0 (0.313)	11.1 (0.438)
HL	C	50.8 (2.000)	M5x0.8-6H	9.5 (0.375)	6.4 (0.250)	L+J	8.0 (0.313)	11.1 (0.438)
CD	D-E	63.5 - 76.2 (2.500 - 3.000)	M5x0.8-6H	8.5 (0.335)	5.0 (0.200)	L+J	13.0 (0.512)	18.8 (0.740)
CP	D-F	63.5 - 89.0 (2.500 - 3.500)	1/4 - 28 NF-2B	8.7 (0.344)	2.4 (0.093)	L+J	17.5 (0.689)	—
CH	D-F	63.5 - 89.0 (2.500 - 3.500)	1/4 - 28 NF-2B	11.9 (0.468)	6.4 (0.250)	L+J	17.5 (0.689)	—
CA	D-F	63.5 - 89.0 (2.500 - 3.500)	M6x1-6H	8.7 (0.344)	2.4 (0.093)	L+J	17.5 (0.689)	—
CS	D-F	63.5 - 89.0 (2.500 - 3.500)	M6x1-6H	11.9 (0.468)	6.4 (0.250)	L+J	17.5 (0.689)	—

Mounting Hardware is optional. Refer to hardware specifications on the following page.

U37D Series

Mounting Hardware - Screw Terminals

Type C: Three-Footed Clamp

Unit: mm (inches)

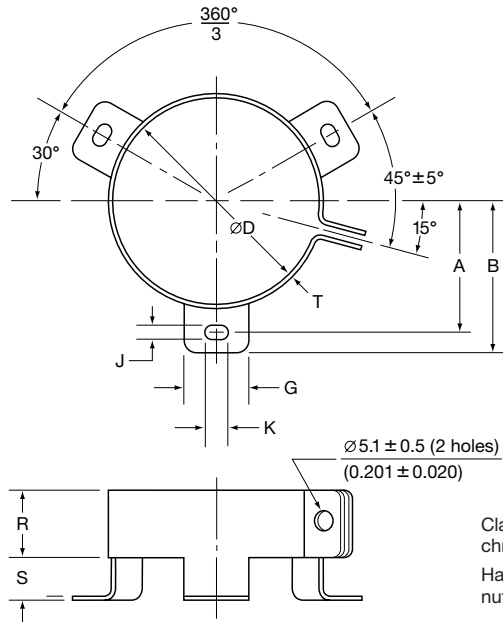

Clamp: Zinc with silver trivalent chromate post treatment.

Hardware: Screw, washer and hexagon nut included with each clamp.

Type C: Clamp Dimensions

Mounting Code	Case ϕD	A $\pm 1.0 (0.040)$	B $\pm 1.0 (0.040)$	G $\pm 1.0 (0.040)$	J $\pm 0.5 (0.020)$	K $\pm 0.5 (0.020)$	R $\pm 1.0 (0.040)$	S $\pm 1.0 (0.040)$	T $\pm 0.5 (0.020)$
C	50.8 (2.000)	31.8 (1.250)	36.5 (1.437)	13.3 (0.524)	4.5 (0.177)	7.1 (0.280)	19.1 (0.751)	9.5 (0.374)	0.8 (0.032)
C	63.5 (2.500)	38.1 (1.500)	42.9 (1.689)	13.3 (0.524)	4.5 (0.177)	7.1 (0.280)	19.1 (0.751)	9.5 (0.374)	0.8 (0.032)
C	76.2 (3.000)	44.5 (1.750)	49.2 (1.937)	13.3 (0.524)	4.5 (0.177)	7.1 (0.280)	19.1 (0.751)	9.5 (0.374)	1.0 (0.040)
C	89.0 (3.500)	50.8 (2.000)	56.5 (2.224)	16.0 (0.630)	4.5 (0.177)	8.0 (0.313)	21.0 (0.827)	9.0 (0.354)	1.0 (0.040)

Type S: Stud Mounting

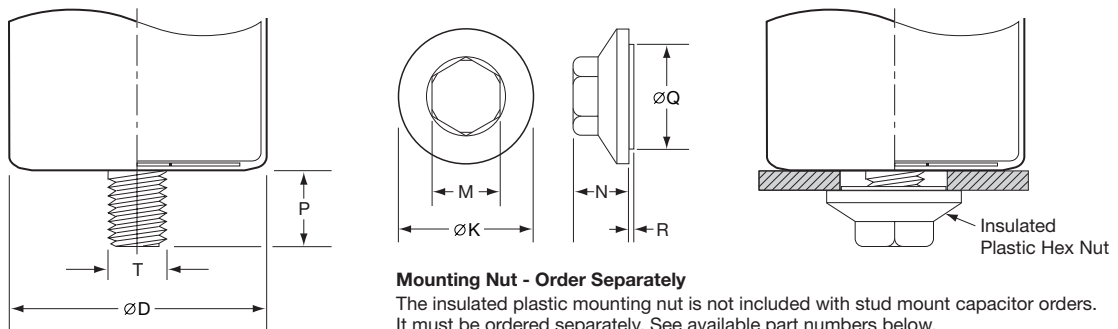

Mounting Nut - Order Separately

The insulated plastic mounting nut is not included with stud mount capacitor orders. It must be ordered separately. See available part numbers below.

Type S: Stud Dimensions

Mounting Code	P $\pm 1.0 (0.040)$	T Thread Size
S	16.0 (0.630)	M12

Mounting Nut Dimensions

Part Number	$\phi K \pm 2.0 (0.080)$	M $\pm 1.0 (0.040)$	N $\pm 1.0 (0.040)$	$\phi Q \pm 1.0 (0.040)$	R $\pm 1.0 (0.040)$
50-8D	30.0 (1.181)	19.0 (0.748)	18.0 (0.709)	22.0 (0.866)	1.40 (0.055)
50-8E	38.0 (1.496)	19.0 (0.748)	18.0 (0.709)	30.0 (1.181)	1.40 (0.055)

U37D Series

Part Numbering System for U37D Series When ordering, always specify complete 18-field global part number.

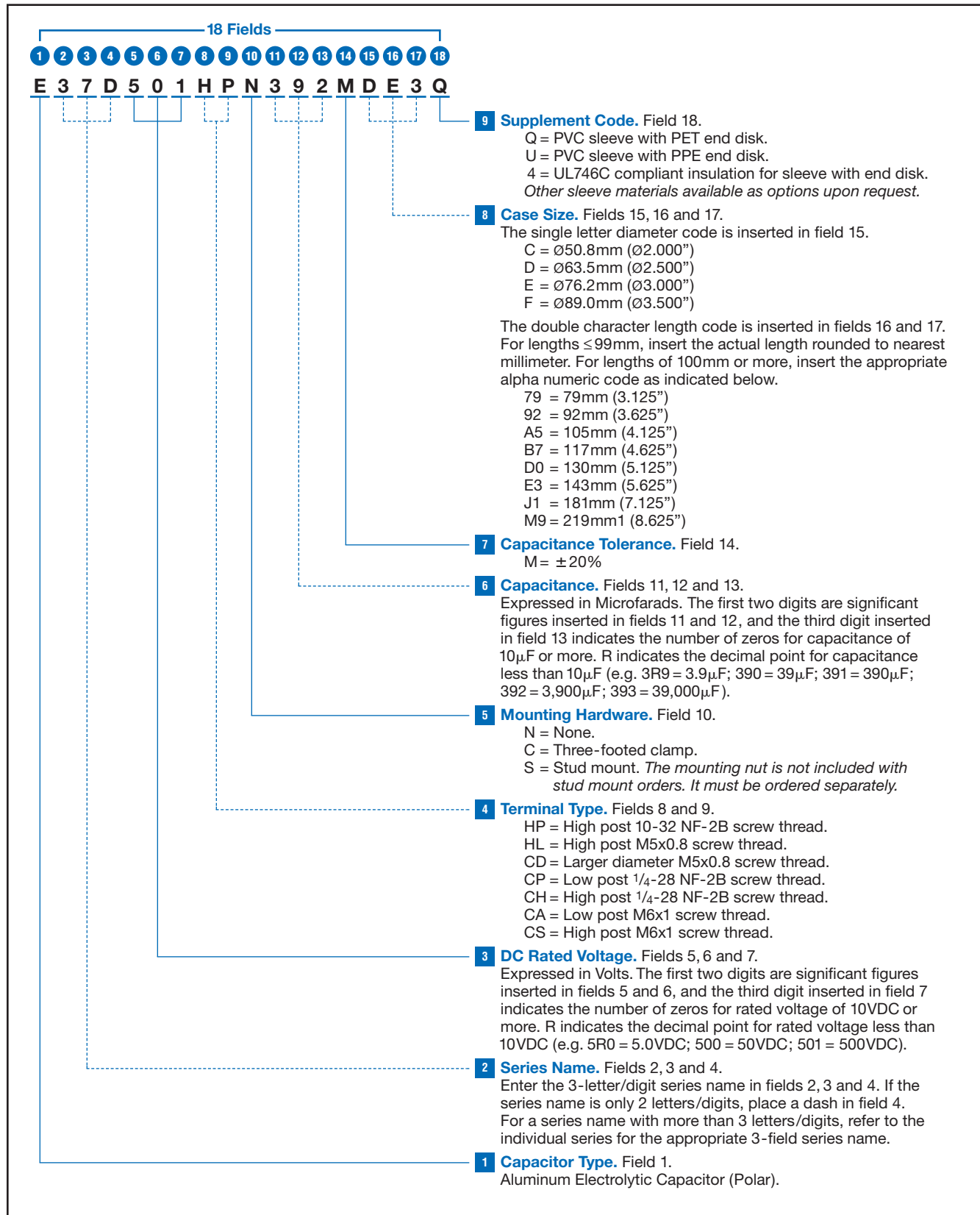

U37D Series

Standard Voltage Ratings - Screw Terminals

Rated Voltage (WVDC)	Capacitance (µF)	Global Part Number†	Nominal Case Size* D × L (mm)	Case Size Code	Maximum ESR (mΩ) at +25°C, 120Hz	Rated Ripple Current (A rms) at +85°C, 120Hz
350 Volts 400 Volts Surge	1,800	E37D351HPN182MC79Q	50.8 × 79	C79	51.1	8.2
	2,200	E37D351HPN222MC92Q	50.8 × 92	C92	41.8	9.6
	2,700	E37D351HPN272MCA5Q	50.8 × 105	CA5	34.1	11.1
	3,300	E37D351HPN332MCB7Q	50.8 × 117	CB7	27.9	12.8
	3,900	E37D351HPN392MCD0Q	50.8 × 130	CD0	23.6	14.4
	3,900	E37D351HPN392MCE3Q	50.8 × 143	CE3	23.6	14.9
	2,700	E37D351CPN272MD79Q	63.5 × 79	D79	34.1	11.3
	4,700	E37D351CPN472MDA5Q	63.5 × 105	DA5	19.6	16.4
	4,700	E37D351CPN472MDB7Q	63.5 × 117	DB7	19.6	17.0
	5,600	E37D351CPN562MDD0Q	63.5 × 130	DD0	16.4	19.4
	6,800	E37D351CPN682MDE3Q	63.5 × 143	DE3	13.5	22.0
	5,600	E37D351CPN562ME92Q	76.2 × 92	E92	16.4	19.1
	6,800	E37D351CPN682MEA5Q	76.2 × 105	EA5	13.5	22.0
	6,800	E37D351CPN682MEB7Q	76.2 × 117	EB7	13.5	22.7
	8,200	E37D351CPN822MED0Q	76.2 × 130	ED0	11.2	25.9
	10,000	E37D351CPN103MEE3Q	76.2 × 143	EE3	9.2	29.6
	18,000	E37D351CPN183MEM9Q	76.2 × 219	EM9	5.1	46.5
	6,800	E37D351CPN682MF92Q	89 × 92	F92	14.7	22.2
	8,200	E37D351CPN822MFA5Q	89 × 105	FA5	12.2	25.3
	10,000	E37D351CPN103MFB7Q	89 × 117	FB7	10.0	29.0
	12,000	E37D351CPN123MFD0Q	89 × 130	FD0	8.3	33.1
	12,000	E37D351CPN123MFE3Q	89 × 143	FE3	8.3	33.8
18,000	E37D351CPN183MFJ1Q	89 × 181	FJ1	5.6	45.8	
22,000	E37D351CPN223MFM9Q	89 × 219	FM9	4.5	53.7	
400 Volts 450 Volts Surge	1,500	E37D401HPN152MC79Q	50.8 × 79	C79	61.3	7.5
	1,800	E37D401HPN182MC92Q	50.8 × 92	C92	51.1	8.6
	2,200	E37D401HPN222MCA5Q	50.8 × 105	CA5	41.8	10.0
	2,700	E37D401HPN272MCB7Q	50.8 × 117	CB7	34.1	11.6
	3,300	E37D401HPN332MCD0Q	50.8 × 130	CD0	27.9	13.2
	3,300	E37D401HPN332MCE3Q	50.8 × 143	CE3	27.9	13.7
	2,700	E37D401CPN272MD79Q	63.5 × 79	D79	34.1	11.3
	3,900	E37D401CPN392MDA5Q	63.5 × 105	DA5	23.6	14.9
	4,700	E37D401CPN472MDB7Q	63.5 × 117	DB7	19.6	17.0
	5,600	E37D401CPN562MDD0Q	63.5 × 130	DD0	16.4	19.4
	5,600	E37D401CPN562MDE3Q	63.5 × 143	DE3	16.4	20.0
	4,700	E37D401CPN472ME92Q	76.2 × 92	E92	19.6	17.5
	5,600	E37D401CPN562MEA5Q	76.2 × 105	EA5	16.4	20.0
	6,800	E37D401CPN682MEB7Q	76.2 × 117	EB7	13.5	22.7
	8,200	E37D401CPN822MED0Q	76.2 × 130	ED0	11.2	25.9
	8,200	E37D401CPN822MEE3Q	76.2 × 143	EE3	11.2	26.8
	15,000	E37D401CPN153MEM9Q	76.2 × 219	EM9	6.1	42.5
	5,600	E37D401CPN562MF92Q	89 × 92	F92	17.9	20.1
	6,800	E37D401CPN682MFA5Q	89 × 105	FA5	14.7	23.0
	8,200	E37D401CPN822MFB7Q	89 × 117	FB7	12.2	26.2
	10,000	E37D401CPN103MFD0Q	89 × 130	FD0	10.0	30.2
	12,000	E37D401CPN123MFE3Q	89 × 143	FE3	8.3	33.8
15,000	E37D401CPN153MFJ1Q	89 × 181	FJ1	6.7	41.8	
18,000	E37D401CPN183MFM9Q	89 × 219	FM9	5.6	48.6	
450 Volts 500 Volts Surge	1,200	E37D451HPN122MC79Q	50.8 × 79	C79	76.7	6.7
	1,500	E37D451HPN152MC92Q	50.8 × 92	C92	61.3	7.9
	1,800	E37D451HPN182MCA5Q	50.8 × 105	CA5	51.1	9.1
	2,200	E37D451HPN222MCB7Q	50.8 × 117	CB7	41.8	10.4
	2,700	E37D451HPN272MCD0Q	50.8 × 130	CD0	34.1	12.0
	2,700	E37D451HPN272MCE3Q	50.8 × 143	CE3	34.1	12.4
	2,200	E37D451CPN222MD79Q	63.5 × 79	D79	41.8	10.2
	3,300	E37D451CPN332MDA5Q	63.5 × 105	DA5	27.9	13.7

† For terminal, mounting and construction options, refer to the part numbering system for descriptions and codes.

* Refer to diagram of dimensions for detailed case size specifications.

U37D Series

Standard Voltage Ratings - Screw Terminals

Rated Voltage (WVDC)	Capacitance (µF)	Global Part Number†	Nominal Case Size* D × L (mm)	Case Size Code	Maximum ESR (mΩ) at +25°C, 120Hz	Rated Ripple Current (A rms) at +85°C, 120Hz
450 Volts 500 Volts Surge	3,900	E37D451CPN392MDB7Q	63.5 × 117	DB7	23.6	15.5
	4,700	E37D451CPN472MDD0Q	63.5 × 130	DD0	19.6	17.8
	4,700	E37D451CPN472MDE3Q	63.5 × 143	DE3	19.6	18.3
	3,900	E37D451CPN392ME92Q	76.2 × 92	E92	23.6	15.9
	4,700	E37D451CPN472MEA5Q	76.2 × 105	EA5	19.6	18.3
	5,600	E37D451CPN562MEB7Q	76.2 × 117	EB7	16.4	20.6
	6,800	E37D451CPN682MED0Q	76.2 × 130	ED0	13.5	23.5
	6,800	E37D451CPN682MEE3Q	76.2 × 143	EE3	13.5	24.4
	12,000	E37D451CPN123MEM9Q	76.2 × 219	EM9	7.7	38.0
	5,600	E37D451CPN562MF92Q	89 × 92	F92	17.9	20.1
	6,800	E37D451CPN682MFA5Q	89 × 105	FA5	14.7	23.0
	6,800	E37D451CPN682MFB7Q	89 × 117	FB7	14.7	23.9
	8,200	E37D451CPN822MFD0Q	89 × 130	FD0	12.2	27.4
	10,000	E37D451CPN103MFE3Q	89 × 143	FE3	10.0	30.9
12,000	E37D451CPN123MFJ1Q	89 × 181	FJ1	8.3	37.4	
18,000	E37D451CPN183MFM9Q	89 × 219	FM9	5.6	48.6	
500 Volts 550 Volts Surge	1,200	E37D501HPN122MC79Q	50.8 × 79	C79	76.7	6.7
	1,500	E37D501HPN152MC92Q	50.8 × 92	C92	61.3	7.9
	1,800	E37D501HPN182MCA5Q	50.8 × 105	CA5	51.1	9.1
	1,800	E37D501HPN182MCB7Q	50.8 × 117	CB7	51.1	9.5
	2,200	E37D501HPN222MCD0Q	50.8 × 130	CD0	41.8	10.8
	2,700	E37D501HPN272MCE3Q	50.8 × 143	CE3	34.1	12.4
	1,500	E37D501CPN152MD79Q	63.5 × 79	D79	61.3	8.4
	2,200	E37D501CPN222MDA5Q	63.5 × 105	DA5	41.8	11.2
	2,700	E37D501CPN272MDB7Q	63.5 × 117	DB7	34.1	12.9
	3,300	E37D501CPN332MDD0Q	63.5 × 130	DD0	27.9	14.9
	3,900	E37D501CPN392MDE3Q	63.5 × 143	DE3	23.6	16.7
	2,700	E37D501CPN272ME92Q	76.2 × 92	E92	34.1	13.3
	3,300	E37D501CPN332MEA5Q	76.2 × 105	EA5	27.9	15.3
	3,900	E37D501CPN392MEB7Q	76.2 × 117	EB7	23.6	17.2
	4,700	E37D501CPN472MED0Q	76.2 × 130	ED0	19.6	19.6
	5,600	E37D501CPN562MEE3Q	76.2 × 143	EE3	16.4	22.2
	8,200	E37D501CPN822MEM9Q	76.2 × 219	EM9	11.2	31.4
	3,900	E37D501CPN392MF92Q	89 × 92	F92	25.6	16.8
	4,700	E37D501CPN472MFA5Q	89 × 105	FA5	21.3	19.1
	5,600	E37D501CPN562MFB7Q	89 × 117	FB7	17.9	21.7
6,800	E37D501CPN682MFD0Q	89 × 130	FD0	14.7	24.9	
6,800	E37D501CPN682MFE3Q	89 × 143	FE3	14.7	25.5	
10,000	E37D501CPN103MFJ1Q	89 × 181	FJ1	10.0	34.2	
12,000	E37D501CPN123MFM9Q	89 × 219	FM9	8.3	39.7	
550 Volts 600 Volts Surge	1,000	E37D551HPN102MC79Q	50.8 × 79	C79	92.0	6.1
	1,200	E37D551HPN122MC92Q	50.8 × 92	C92	76.7	7.1
	1,500	E37D551HPN152MCA5Q	50.8 × 105	CA5	61.3	8.3
	1,500	E37D551HPN152MCB7Q	50.8 × 117	CB7	61.3	8.6
	1,800	E37D551HPN182MCD0Q	50.8 × 130	CD0	51.1	9.8
	2,200	E37D551HPN222MCE3Q	50.8 × 143	CE3	41.8	11.2
	1,200	E37D551CPN122MD79Q	63.5 × 79	D79	76.7	7.6
	1,800	E37D551CPN182MDA5Q	63.5 × 105	DA5	51.1	10.1
	2,200	E37D551CPN222MDB7Q	63.5 × 117	DB7	41.8	11.7
	2,700	E37D551CPN272MDD0Q	63.5 × 130	DD0	34.1	13.5
	2,700	E37D551CPN272MDE3Q	63.5 × 143	DE3	34.1	13.9
	2,200	E37D551CPN222ME92Q	76.2 × 92	E92	41.8	12.0
	2,700	E37D551CPN272MEA5Q	76.2 × 105	EA5	34.1	13.9
	3,300	E37D551CPN332MEB7Q	76.2 × 117	EB7	27.9	15.8
3,900	E37D551CPN392MED0Q	76.2 × 130	ED0	23.6	17.8	

† For terminal, mounting and construction options, refer to the part numbering system for descriptions and codes.

* Refer to diagram of dimensions for detailed case size specifications.

U37D Series

Standard Voltage Ratings - Screw Terminals

Rated Voltage (WVDC)	Capacitance (µF)	Global Part Number†	Nominal Case Size* D × L (mm)	Case Size Code	Maximum ESR (mΩ) at +25°C, 120Hz	Rated Ripple Current (A rms) at +85°C, 120Hz
550 Volts 600 Volts Surge	4,700	E37D551CPN472MEE3Q	76.2 × 143	EE3	19.6	20.3
	6,800	E37D551CPN682MEM9Q	76.2 × 219	EM9	13.5	28.6
	3,300	E37D551CPN332MF92Q	89 × 92	F92	30.3	15.5
	3,900	E37D551CPN392MFA5Q	89 × 105	FA5	25.6	17.4
	4,700	E37D551CPN472MFB7Q	89 × 117	FB7	21.3	19.9
	4,700	E37D551CPN472MFD0Q	89 × 130	FD0	21.3	20.7
	5,600	E37D551CPN562MFE3Q	89 × 143	FE3	17.9	23.1
	8,200	E37D551CPN822MFJ1Q	89 × 181	FJ1	12.2	30.9
	10,000	E37D551CPN103MFM9Q	89 × 219	FM9	10.0	36.2

† For terminal, mounting and construction options, refer to the part numbering system for descriptions and codes.

* Refer to diagram of dimensions for detailed case size specifications.

U33F Series



- Large Can
- Screw Terminals
- High Ripple
- 350 to 500VDC Ratings
- RoHS Compliant
- +105°C Maximum Temperature
- 5,000 Hours Lifetime at +105°C
- Up to 175,000 Hours Useful Life

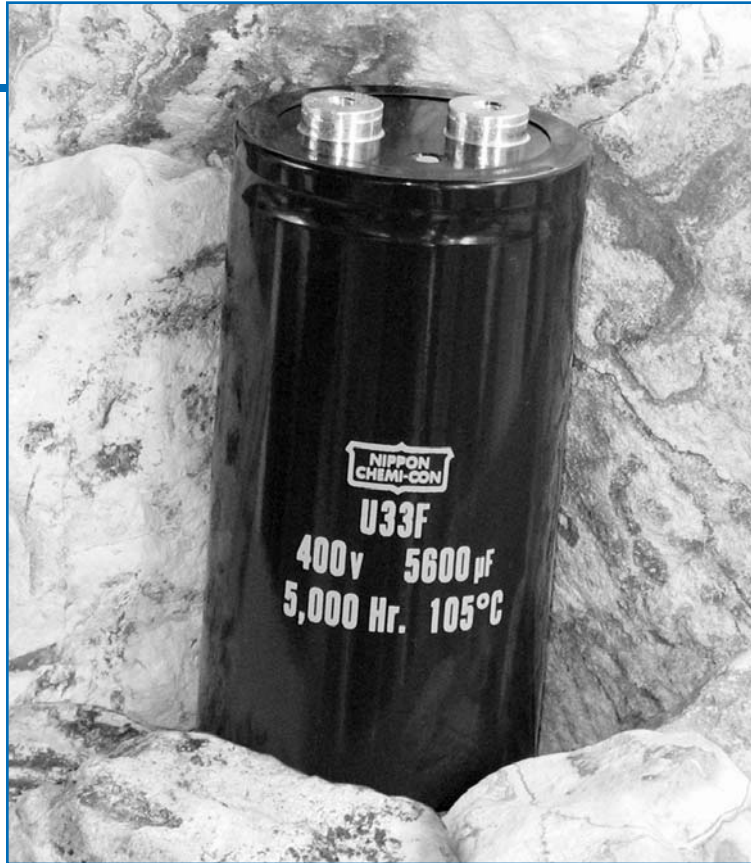

The U33F series is a high temperature screw mount series specifically designed to provide the ripple current capability and long life required for high reliability inverter applications. The U33F has an endurance rating of 5,000 hours at +105°C with the rated ripple current applied. The useful life can exceed 175,000 hours at +40°C and 1.5x the ripple current. These capacitors are available in a variety of high current English or Metric thread terminals. Mounting options include a three-footed clamp or bottom threaded stud. Custom designs are also available.

Summary of Specifications

- Screw terminals: high and low post, English and Metric thread.
- Capacitance range: 1,200 to 15,000µF.
- Voltage range: 350 to 500VDC.
- Category temperature range: -40°C to +105°C.
- Leakage current: 0.02CV(µA) or 5mA, whichever is smaller, after 5 minutes at +25°C.
- Standard capacitance tolerance: ±20%
- Nominal case size (D × L): D = 50.8mm (2.000") to 89mm (3.500"); L = 92mm (3.625") to 219mm (8.625").
- Rated lifetime: 5,000 hours at +105°C with rated ripple current applied.

U33F Series

U33F Specifications - Screw Terminals

Item	Characteristics																																															
Category Temperature Range	-40 to +105°C																																															
Rated Voltage Range	350 to 500VDC																																															
Capacitance Range	1,200 to 15,000 μ F at +25°C, 120Hz																																															
Capacitance Tolerance	\pm 20% (M) at +25°C, 120Hz																																															
Leakage Current	$I = 0.02CV$ (μ A) or 5mA, whichever is smaller, after 5 minutes at +25°C. Where I = Max. leakage current (μ A), C = Nominal capacitance (μ F) and V = Rated voltage (V)																																															
Rated Ripple Current Multipliers	<p>Ambient Temperature (°C)</p> <table border="1"> <tr> <td>+65°C</td> <td>+85°C</td> <td>+105°C</td> </tr> <tr> <td>2.20</td> <td>1.73</td> <td>1.00</td> </tr> </table> <p>Frequency (Hz)</p> <table border="1"> <tr> <td>DC Rated Voltage</td> <td>50Hz</td> <td>120Hz</td> <td>300Hz</td> <td>1kHz</td> <td>10kHz</td> <td>100kHz</td> </tr> <tr> <td>350-450V</td> <td>0.77</td> <td>1.00</td> <td>1.16</td> <td>1.30</td> <td>1.41</td> <td>1.43</td> </tr> <tr> <td>500V</td> <td>0.70</td> <td>1.00</td> <td>1.16</td> <td>1.30</td> <td>1.41</td> <td>1.43</td> </tr> </table> <p>To determine maximum ripple current at a specified temperature and frequency, use the appropriate multiplier shown.</p>	+65°C	+85°C	+105°C	2.20	1.73	1.00	DC Rated Voltage	50Hz	120Hz	300Hz	1kHz	10kHz	100kHz	350-450V	0.77	1.00	1.16	1.30	1.41	1.43	500V	0.70	1.00	1.16	1.30	1.41	1.43																				
+65°C	+85°C	+105°C																																														
2.20	1.73	1.00																																														
DC Rated Voltage	50Hz	120Hz	300Hz	1kHz	10kHz	100kHz																																										
350-450V	0.77	1.00	1.16	1.30	1.41	1.43																																										
500V	0.70	1.00	1.16	1.30	1.41	1.43																																										
Endurance (Load Life)	<p>The following specifications shall be satisfied when the capacitors are restored to +25°C after subjecting them to DC voltage for 5,000 hours at +105°C with the rated ripple current applied. The sum of the DC voltage and peak AC voltage must not exceed the full rated voltage of the capacitors.</p> <p>Capacitance change: \leq 20% from initial measurement ESR change : \leq 200% of initial specified limit Leakage current : \leq initial specified limit</p>																																															
Useful Life	<p>With specified standard voltage and ripple current applied, typical life as function of ambient temperature is listed below.</p> <table border="1"> <tr> <td>+105°C</td> <td>6,500 hours max.</td> <td rowspan="3"> Capacitance change: \leq 30% from initial measurement ESR change : \leq 300% of initial specified limit Leakage current : \leq initial specified limit </td> </tr> <tr> <td>+85°C</td> <td>24,000 hours max.</td> </tr> <tr> <td>+65°C</td> <td>122,000 hours max.</td> </tr> </table>	+105°C	6,500 hours max.	Capacitance change: \leq 30% from initial measurement ESR change : \leq 300% of initial specified limit Leakage current : \leq initial specified limit	+85°C	24,000 hours max.	+65°C	122,000 hours max.																																								
+105°C	6,500 hours max.	Capacitance change: \leq 30% from initial measurement ESR change : \leq 300% of initial specified limit Leakage current : \leq initial specified limit																																														
+85°C	24,000 hours max.																																															
+65°C	122,000 hours max.																																															
Shelf Life	<p>The following specifications shall be satisfied when the capacitors are restored to +25°C after exposing them for 500 hours at +105°C without voltage applied. The rated voltage shall be applied to the capacitors for a minimum of 30 minutes, at least 24 hours and not more than 48 hours before the measurements.</p> <p>Capacitance change: \leq 20% from initial measurement ESR change : \leq 200% of initial specified limit Leakage current : \leq initial specified limit</p>																																															
Vibration Rating	10-55Hz, 10g sinusoidal in three axes, 2 hours per axis.																																															
Maximum Tightening Torque	<table border="1"> <tr> <td>Terminal Code</td> <td>HP</td> <td>HL</td> <td>CD</td> <td>CP</td> <td>CH</td> <td>CA</td> <td>CS</td> </tr> <tr> <td>Thread Size</td> <td>10-32 NF-2B</td> <td>M5x0.8-6H</td> <td></td> <td>1/4-28 NF-2B</td> <td></td> <td>M6x1-6H</td> <td></td> </tr> <tr> <td>3 Threads Engaged</td> <td colspan="3">2.0 N·m (18.0 in·lb)</td> <td colspan="4">4.0 N·m (35.0 in·lb)</td> </tr> <tr> <td>6 Threads Engaged</td> <td colspan="3">2.8 N·m (25.0 in·lb)</td> <td colspan="4">6.2 N·m (55.0 in·lb)</td> </tr> </table>	Terminal Code	HP	HL	CD	CP	CH	CA	CS	Thread Size	10-32 NF-2B	M5x0.8-6H		1/4-28 NF-2B		M6x1-6H		3 Threads Engaged	2.0 N·m (18.0 in·lb)			4.0 N·m (35.0 in·lb)				6 Threads Engaged	2.8 N·m (25.0 in·lb)			6.2 N·m (55.0 in·lb)																		
Terminal Code	HP	HL	CD	CP	CH	CA	CS																																									
Thread Size	10-32 NF-2B	M5x0.8-6H		1/4-28 NF-2B		M6x1-6H																																										
3 Threads Engaged	2.0 N·m (18.0 in·lb)			4.0 N·m (35.0 in·lb)																																												
6 Threads Engaged	2.8 N·m (25.0 in·lb)			6.2 N·m (55.0 in·lb)																																												
Typical Inductance (nH) at 1MHz	<table border="1"> <tr> <td rowspan="2">Case Diameter (mm)</td> <td colspan="7">Terminal Code</td> </tr> <tr> <td>HP</td> <td>HL</td> <td>CD</td> <td>CP</td> <td>CH</td> <td>CA</td> <td>CS</td> </tr> <tr> <td>\varnothing50.8</td> <td>—</td> <td>—</td> <td>NA</td> <td>NA</td> <td>NA</td> <td>NA</td> <td>NA</td> </tr> <tr> <td>\varnothing63.5</td> <td>—</td> <td>—</td> <td>—</td> <td>—</td> <td>—</td> <td>—</td> <td>—</td> </tr> <tr> <td>\varnothing76.2</td> <td>30</td> <td>30</td> <td>25</td> <td>20</td> <td>25</td> <td>20</td> <td>25</td> </tr> <tr> <td>\varnothing89.0</td> <td>30</td> <td>30</td> <td>25</td> <td>20</td> <td>25</td> <td>20</td> <td>25</td> </tr> </table>	Case Diameter (mm)	Terminal Code							HP	HL	CD	CP	CH	CA	CS	\varnothing 50.8	—	—	NA	NA	NA	NA	NA	\varnothing 63.5	—	—	—	—	—	—	—	\varnothing 76.2	30	30	25	20	25	20	25	\varnothing 89.0	30	30	25	20	25	20	25
Case Diameter (mm)	Terminal Code																																															
	HP	HL	CD	CP	CH	CA	CS																																									
\varnothing 50.8	—	—	NA	NA	NA	NA	NA																																									
\varnothing 63.5	—	—	—	—	—	—	—																																									
\varnothing 76.2	30	30	25	20	25	20	25																																									
\varnothing 89.0	30	30	25	20	25	20	25																																									
Custom Designs	Custom CV values per case size and termination type may be available upon request. Contact appropriate representative with specific requirements.																																															

U33F Series

U33F Useful Life

Useful Life: 6,500 Hours at +105°C

The life expectancy of a capacitor is shown as a function of ambient temperature and ripple current load.

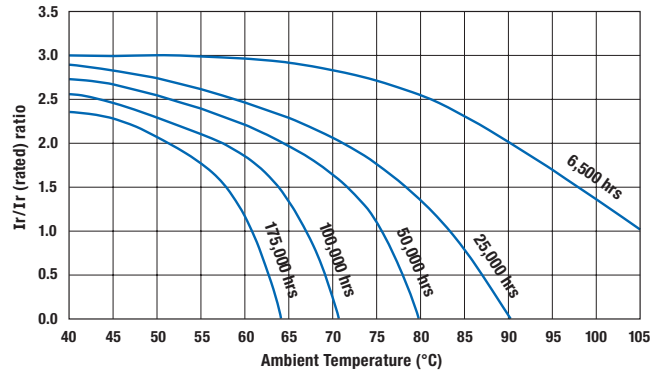
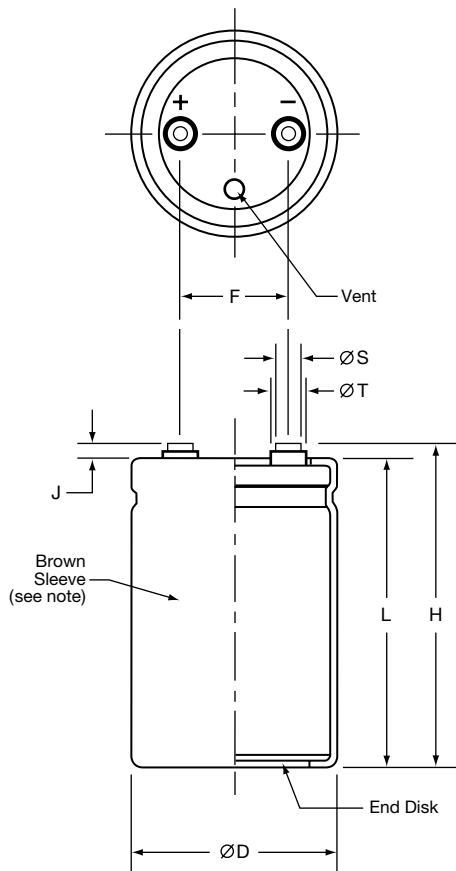

Diagram of Dimensions - Screw Terminals

Large Can/Screw Terminals

Unit: mm (inches)



Case Dimensions and Standard Box Quantities

Case Size Code	$\varnothing D$ +2.0 (0.080)	L ± 1.0 (0.040)	F ± 0.25 (0.010)	Standard Box Quantity
CB7 CD0	50.8 (2.000)	117 (4.625) 130 (5.125)	22.2 (0.875)	49
D92 DA5 DB7 DD0 DE3	63.5 (2.500)	92 (3.625) 105 (4.125) 117 (4.625) 130 (5.125) 143 (5.625)	28.6 (1.125)	20
E92 EA5 EB7 EE3 EJ1 EM9	76.2 (3.000)	92 (3.625) 105 (4.125) 117 (4.625) 143 (5.625) 181 (7.125) 219 (8.625)	31.8 (1.250)	16 9
F92 FA5 FB7 FE3 FF5 FK0 FM9	89.0 (3.500)	92 (3.625) 105 (4.125) 117 (4.625) 143 (5.625) 155 (6.125) 190 (7.500) 219 (8.625)	31.8 (1.250)	5

Note:
In some cases, the color of the sleeve may change slightly due to the operating conditions, however, the discoloration will not impair capacitor function.

Terminal Specifications

Terminal Code	Available Case Diameter		Thread Size	Minimum Thread Depth	J ± 0.5 (0.020)	H ± 2.0 (0.080)	$\varnothing S$ ± 0.25 (0.010)	$\varnothing T$ ± 0.25 (0.010)
	$\varnothing D$ Code	$\varnothing D$ mm (inches)						
HP	C	50.8 (2.000)	10-32 NF-2B	9.5 (0.375)	6.4 (0.250)	L+J	8.0 (0.313)	11.1 (0.438)
HL	C	50.8 (2.000)	M5x0.8-6H	9.5 (0.375)	6.4 (0.250)	L+J	8.0 (0.313)	11.1 (0.438)
CD	D-E	63.5 - 76.2 (2.500 - 3.000)	M5x0.8-6H	8.5 (0.335)	5.0 (0.200)	L+J	13.0 (0.512)	18.8 (0.740)
CP	D-F	63.5 - 89.0 (2.500 - 3.500)	1/4 - 28 NF-2B	8.7 (0.344)	2.4 (0.093)	L+J	17.5 (0.689)	—
CH	D-F	63.5 - 89.0 (2.500 - 3.500)	1/4 - 28 NF-2B	11.9 (0.468)	6.4 (0.250)	L+J	17.5 (0.689)	—
CA	D-F	63.5 - 89.0 (2.500 - 3.500)	M6x1-6H	8.7 (0.344)	2.4 (0.093)	L+J	17.5 (0.689)	—
CS	D-F	63.5 - 89.0 (2.500 - 3.500)	M6x1-6H	11.9 (0.468)	6.4 (0.250)	L+J	17.5 (0.689)	—

Mounting Hardware is optional. Refer to hardware specifications on the following page.

U33F Series

Part Numbering System for U33F Series When ordering, always specify complete 18-field global part number.

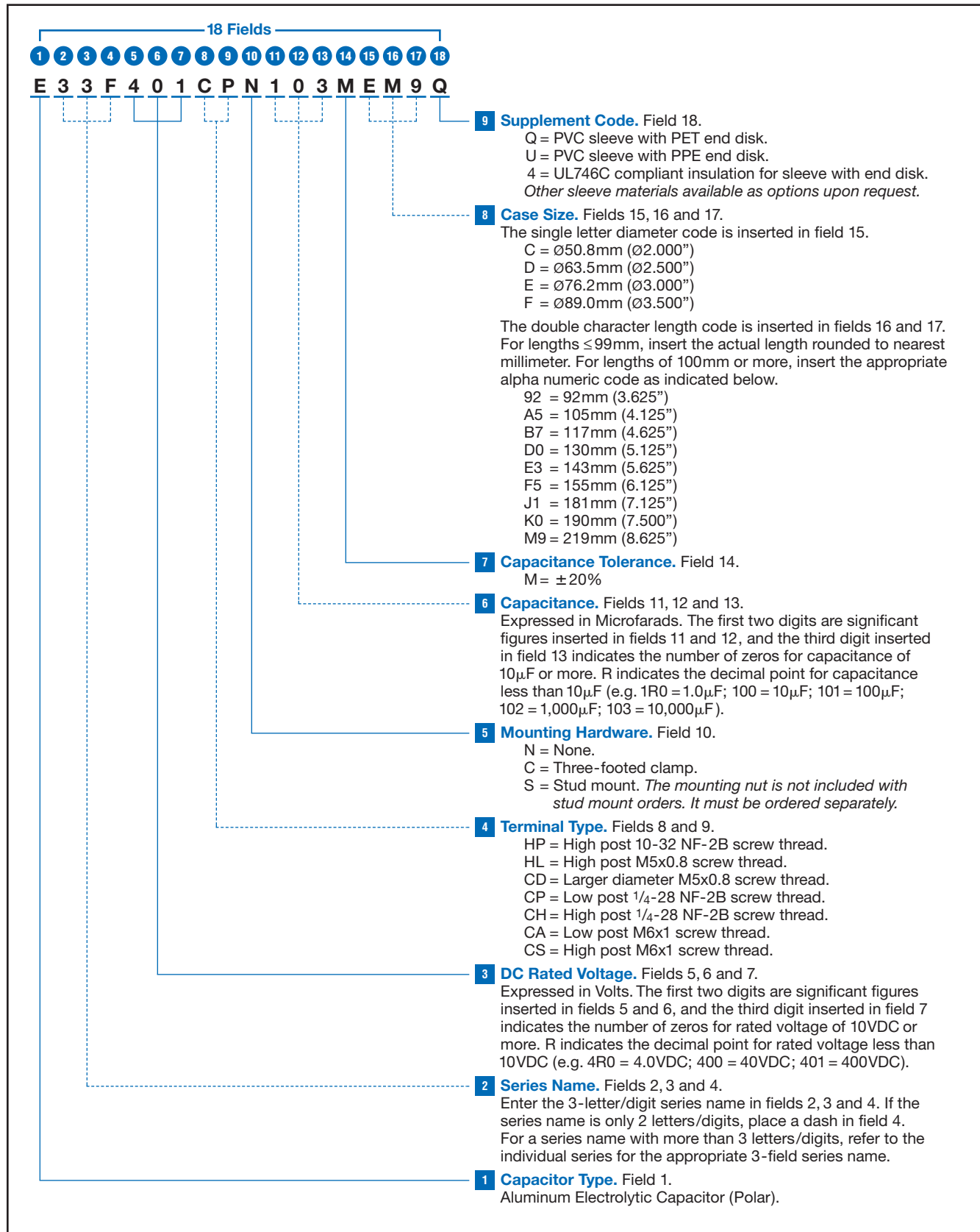

U33F Series

Standard Voltage Ratings - Screw Terminals

Rated Voltage (WVDC)	Capacitance (µF)	Global Part Number†	Nominal Case Size* D × L (mm)	Case Size Code	Maximum ESR (mΩ) at +25°C, 120Hz	Rated Ripple Current (A rms) at +105°C		
						120Hz	300Hz	>3kHz
350 Volts 400 Volts Surge	1,800	E33F351HPN182MCB7Q	50.8 × 117	CB7	58	7.5	9.0	10.5
	2,200	E33F351HPN222MCD0Q	50.8 × 130	CD0	51	8.3	9.9	11.6
	2,200	E33F351CPN222MD92Q	63.5 × 92	D92	48	8.5	10.2	11.9
	2,700	E33F351CPN272MDA5Q	63.5 × 105	DA5	40	9.7	11.7	13.6
	3,300	E33F351CPN332MDB7Q	63.5 × 117	DB7	34	10.9	13.1	15.3
	3,900	E33F351CPN392MDD0Q	63.5 × 130	DD0	30	12.1	14.6	17.0
	3,900	E33F351CPN392MDE3Q	63.5 × 143	DE3	29	12.8	15.4	17.9
	3,300	E33F351CPN332ME92Q	76.2 × 92	E92	34	11.2	13.4	15.6
	3,900	E33F351CPN392MEA5Q	76.2 × 105	EA5	28	12.8	15.3	17.9
	5,600	E33F351CPN562MEB7Q	76.2 × 117	EB7	21	15.3	18.4	21.4
	6,800	E33F351CPN682MEE3Q	76.2 × 143	EE3	19	17.4	20.9	24.4
	8,200	E33F351CPN822MEJ1Q	76.2 × 181	EJ1	14	22.0	26.4	30.8
	10,000	E33F351CPN103MEM9Q	76.2 × 219	EM9	11	26.5	31.8	37.1
	4,700	E33F351CPN472MF92Q	89 × 92	F92	25	14.3	17.1	20.0
	5,600	E33F351CPN562MFA5Q	89 × 105	FA5	21	16.3	19.5	22.8
	6,800	E33F351CPN682MFB7Q	89 × 117	FB7	18	18.3	21.9	25.6
	8,200	E33F351CPN822MFE3Q	89 × 143	FE3	14	22.2	26.6	31.0
	10,000	E33F351CPN103MFF5Q	89 × 155	FF5	13	24.1	28.9	33.7
12,000	E33F351CPN123MFK0Q	89 × 190	FK0	10	29.3	35.2	41.1	
15,000	E33F351CPN153MFM9Q	89 × 219	FM9	8	33.6	40.4	47.1	
400 Volts 450 Volts Surge	1,800	E33F401HPN182MCB7Q	50.8 × 117	CB7	58	7.5	9.0	10.5
	2,200	E33F401HPN222MCD0Q	50.8 × 130	CD0	50	8.3	10.0	11.6
	2,200	E33F401CPN222MD92Q	63.5 × 92	D92	47	8.5	10.2	12.0
	2,700	E33F401CPN272MDA5Q	63.5 × 105	DA5	40	9.8	11.7	13.7
	3,300	E33F401CPN332MDB7Q	63.5 × 117	DB7	34	11.0	13.2	15.4
	3,900	E33F401CPN392MDD0Q	63.5 × 130	DD0	30	12.2	14.6	17.0
	3,900	E33F401CPN392MDE3Q	63.5 × 143	DE3	26	13.4	16.0	18.7
	3,300	E33F401CPN332ME92Q	76.2 × 92	E92	34	11.2	13.4	15.7
	3,900	E33F401CPN392MEA5Q	76.2 × 105	EA5	28	12.8	15.4	17.9
	4,700	E33F401CPN472MEB7Q	76.2 × 117	EB7	24	14.4	17.3	20.1
	5,600	E33F401CPN562MEE3Q	76.2 × 143	EE3	19	17.5	21.0	24.5
	8,200	E33F401CPN822MEJ1Q	76.2 × 181	EJ1	14	22.1	26.5	30.9
	10,000	E33F401CPN103MEM9Q	76.2 × 219	EM9	11	26.6	31.9	37.2
	4,700	E33F401CPN472MF92Q	89 × 92	F92	25	14.3	17.2	20.0
	5,600	E33F401CPN562MFA5Q	89 × 105	FA5	21	16.3	19.6	22.9
	6,800	E33F401CPN682MFB7Q	89 × 117	FB7	18	18.3	22.0	25.6
	8,200	E33F401CPN822MFE3Q	89 × 143	FE3	14	22.2	26.7	31.1
	10,000	E33F401CPN103MFF5Q	89 × 155	FF5	12	24.1	29.0	33.8
12,000	E33F401CPN123MFK0Q	89 × 190	FK0	10	29.4	35.3	41.2	
15,000	E33F401CPN153MFM9Q	89 × 219	FM9	8	33.7	40.5	47.2	
420 Volts 470 Volts Surge	1,500	E33F421HPN152MCB7Q	50.8 × 117	CB7	69	6.9	8.2	9.6
	1,800	E33F421HPN182MCD0Q	50.8 × 130	CD0	60	7.6	9.1	10.7
	1,800	E33F421CPN182MD92Q	63.5 × 92	D92	57	7.8	9.4	10.9
	2,200	E33F421CPN222MDA5Q	63.5 × 105	DA5	47	8.9	10.7	12.5
	2,700	E33F421CPN272MDB7Q	63.5 × 117	DB7	40	10.1	12.1	14.1
	3,300	E33F421CPN332MDD0Q	63.5 × 130	DD0	35	11.1	13.4	15.6
	3,300	E33F421CPN332MDE3Q	63.5 × 143	DE3	34	11.8	14.1	16.5
	2,700	E33F421CPN272ME92Q	76.2 × 92	E92	40	10.3	12.3	14.4
	3,300	E33F421CPN332MEA5Q	76.2 × 105	EA5	34	11.7	14.1	16.4
	3,900	E33F421CPN392MEB7Q	76.2 × 117	EB7	29	13.2	15.8	18.4
	5,600	E33F421CPN562MEE3Q	76.2 × 143	EE3	22	16.0	19.2	22.4
	6,800	E33F421CPN682MEJ1Q	76.2 × 181	EJ1	17	19.8	23.8	27.8
	8,200	E33F421CPN822MEM9Q	76.2 × 219	EM9	14	23.9	28.7	33.5
	3,900	E33F421CPN392MF92Q	89 × 92	F92	30	13.1	15.7	18.3
	4,700	E33F421CPN472MFA5Q	89 × 105	FA5	25	15.0	17.9	20.9

†For terminal, mounting and construction options, refer to the part numbering system for descriptions and codes.

* Refer to diagram of dimensions for detailed case size specifications.

U33F Series

Standard Voltage Ratings - Screw Terminals

Rated Voltage (WVDC)	Capacitance (µF)	Global Part Number†	Nominal Case Size* D × L (mm)	Case Size Code	Maximum ESR (mΩ) at +25°C, 120Hz	Rated Ripple Current (A rms) at +105°C		
						120Hz	300Hz	>3kHz
420 Volts 470 Volts Surge	5,600	E33F421CPN562MFB7Q	89 × 117	FB7	21	16.8	20.1	23.5
	8,200	E33F421CPN822MFE3Q	89 × 143	FE3	17	20.4	24.4	28.5
	8,200	E33F421CPN822MFF5Q	89 × 155	FF5	15	22.1	26.5	31.0
	10,000	E33F421CPN103MFK0Q	89 × 190	FK0	12	26.9	32.3	37.7
	12,000	E33F421CPN123MFM9Q	89 × 219	FM9	10	30.9	37.1	43.3
450 Volts 500 Volts Surge	1,500	E33F451HPN152MCB7Q	50.8 × 117	CB7	69	6.9	8.2	9.6
	1,800	E33F451HPN182MCD0Q	50.8 × 130	CD0	60	7.6	9.1	10.6
	1,800	E33F451CPN182MD92Q	63.5 × 92	D92	57	7.8	9.4	10.9
	2,200	E33F451CPN222MDA5Q	63.5 × 105	DA5	47	8.9	10.7	12.5
	2,700	E33F451CPN272MDB7Q	63.5 × 117	DB7	40	10.0	12.0	14.1
	3,300	E33F451CPN332MDD0Q	63.5 × 130	DD0	35	11.1	13.4	15.6
	3,300	E33F451CPN332MDE3Q	63.5 × 143	DE3	34	11.8	14.1	16.5
	2,700	E33F451CPN272ME92Q	76.2 × 92	E92	40	10.3	12.3	14.4
	3,300	E33F451CPN332MEA5Q	76.2 × 105	EA5	34	11.7	14.1	16.4
	3,900	E33F451CPN392MEB7Q	76.2 × 117	EB7	29	13.2	15.8	18.4
	4,700	E33F451CPN472MEE3Q	76.2 × 143	EE3	22	16.0	19.2	22.4
	6,800	E33F451CPN682MEJ1Q	76.2 × 181	EJ1	17	20.2	24.2	28.3
	8,200	E33F451CPN822MEM9Q	76.2 × 219	EM9	13	24.3	29.2	34.1
	3,900	E33F451CPN392MF92Q	89 × 92	F92	30	13.1	15.7	18.3
	4,700	E33F451CPN472MFA5Q	89 × 105	FA5	25	14.9	17.9	20.9
	5,600	E33F451CPN562MFB7Q	89 × 117	FB7	21	16.8	20.1	23.5
	6,800	E33F451CPN682MFE3Q	89 × 143	FE3	17	20.3	24.4	28.5
8,200	E33F451CPN822MFF5Q	89 × 155	FF5	15	22.1	26.5	30.9	
10,000	E33F451CPN103MFK0Q	89 × 190	FK0	12	26.9	32.3	37.7	
12,000	E33F451CPN123MFM9Q	89 × 219	FM9	10	30.9	37.0	43.2	
500 Volts 550 Volts Surge	1,200	E33F501HPN122MCB7Q	50.8 × 117	CB7	82	6.3	7.5	8.8
	1,500	E33F501HPN152MCD0Q	50.8 × 130	CD0	72	6.9	8.3	9.7
	1,500	E33F501CPN152MD92Q	63.5 × 92	D92	71	7.0	8.4	9.8
	1,800	E33F501CPN182MDA5Q	63.5 × 105	DA5	59	8.0	9.6	11.2
	2,200	E33F501CPN222MDB7Q	63.5 × 117	DB7	51	9.0	10.8	12.6
	2,200	E33F501CPN222MDD0Q	63.5 × 130	DD0	44	10.0	12.0	13.9
	2,700	E33F501CPN272MDE3Q	63.5 × 143	DE3	39	10.9	13.1	15.3
	2,200	E33F501CPN222ME92Q	76.2 × 92	E92	51	9.2	11.0	12.8
	2,700	E33F501CPN272MEA5Q	76.2 × 105	EA5	42	10.5	12.6	14.7
	3,300	E33F501CPN332MEB7Q	76.2 × 117	EB7	36	11.8	14.1	16.5
	3,900	E33F501CPN392MEE3Q	76.2 × 143	EE3	28	14.3	17.2	20.0
	5,600	E33F501CPN562MEJ1Q	76.2 × 181	EJ1	21	18.1	21.7	25.3
	6,800	E33F501CPN682MEM9Q	76.2 × 219	EM9	17	21.8	26.1	30.5
	3,300	E33F501CPN332MF92Q	89 × 92	F92	37	11.7	14.0	16.4
	3,900	E33F501CPN392MFA5Q	89 × 105	FA5	31	13.4	16.0	18.7
	4,700	E33F501CPN472MFB7Q	89 × 117	FB7	27	15.0	18.0	21.0
	5,600	E33F501CPN562MFE3Q	89 × 143	FE3	21	18.2	21.8	25.5
6,800	E33F501CPN682MFF5Q	89 × 155	FF5	19	19.8	23.7	27.7	
8,200	E33F501CPN822MFK0Q	89 × 190	FK0	15	24.1	28.9	33.7	
10,000	E33F501CPN103MFM9Q	89 × 219	FM9	12	27.6	33.1	38.7	

†For terminal, mounting and construction options, refer to the part numbering system for descriptions and codes.

*Refer to diagram of dimensions for detailed case size specifications.

U37F Series



- Large Can
- Screw Terminals
- High Ripple
- 350 to 500VDC Ratings
- RoHS Compliant
- +85°C Maximum Temperature
- 5,000 Hours Lifetime at +85°C
- Up to 150,000 Hours Useful Life



The U37F series is a screw mount U37 grade series specifically designed to provide the ripple current capability and long life required for high reliability inverter applications. The U37F has an endurance rating of 5,000 hours at +85°C with the rated ripple current applied. The useful life can exceed 150,000 hours at +40°C and 1.5x the ripple current. These capacitors are available in a variety of high current English or Metric thread terminals. Mounting options include a three-footed clamp or bottom threaded stud. Custom designs are also available.

Summary of Specifications

- Screw terminals: high and low post, English and Metric thread.
- Capacitance range: 1,500 to 22,000µF.
- Voltage range: 350 to 500VDC.
- Category temperature range: -40°C to +85°C.
- Leakage current: 0.02CV(µA) or 5mA, whichever is smaller, after 5 minutes at +25°C.
- Standard capacitance tolerance: ±20%
- Nominal case size (D×L): D = 50.8mm (2.000") to 89mm (3.500"); L = 92mm (3.625") to 219mm (8.625").
- Rated lifetime: 5,000 hours at +85°C with rated ripple current applied.

U37F Series

U37F Specifications - Screw Terminals

Item	Characteristics																																															
Category Temperature Range	- 40 to +85°C																																															
Rated Voltage Range	350 to 500VDC																																															
Capacitance Range	1,500 to 22,000 μ F at +25°C, 120Hz																																															
Capacitance Tolerance	\pm 20% (M) at +25°C, 120Hz																																															
Leakage Current	$I = 0.02CV$ (μ A) or 5mA, whichever is smaller, after 5 minutes at +25°C. Where I = Max. leakage current (μ A), C = Nominal capacitance (μ F) and V = Rated voltage (V)																																															
Rated Ripple Current Multipliers	<p>Ambient Temperature (°C)</p> <table border="1"> <thead> <tr> <th>+45°C</th> <th>+65°C</th> <th>+85°C</th> </tr> </thead> <tbody> <tr> <td>2.82</td> <td>1.73</td> <td>1.00</td> </tr> </tbody> </table> <p>Frequency (Hz)</p> <table border="1"> <thead> <tr> <th>DC Rated Voltage</th> <th>50Hz</th> <th>120Hz</th> <th>300Hz</th> <th>1kHz</th> <th>3kHz</th> <th>10kHz</th> </tr> </thead> <tbody> <tr> <td>350-500V</td> <td>0.80</td> <td>1.00</td> <td>1.20</td> <td>1.30</td> <td>1.40</td> <td>1.41</td> </tr> </tbody> </table> <p>To determine maximum ripple current at a specified temperature and frequency, use the appropriate multiplier shown.</p>	+45°C	+65°C	+85°C	2.82	1.73	1.00	DC Rated Voltage	50Hz	120Hz	300Hz	1kHz	3kHz	10kHz	350-500V	0.80	1.00	1.20	1.30	1.40	1.41																											
+45°C	+65°C	+85°C																																														
2.82	1.73	1.00																																														
DC Rated Voltage	50Hz	120Hz	300Hz	1kHz	3kHz	10kHz																																										
350-500V	0.80	1.00	1.20	1.30	1.40	1.41																																										
Endurance (Load Life)	<p>The following specifications shall be satisfied when the capacitors are restored to +25°C after subjecting them to DC voltage for 5,000 hours at +85°C with the rated ripple current applied. The sum of the DC voltage and peak AC voltage must not exceed the full rated voltage of the capacitors.</p> <p>Capacitance change: \leq 20% from initial measurement ESR change : \leq 200% of initial specified limit Leakage current : \leq initial specified limit</p>																																															
Useful Life	<p>With specified standard voltage and ripple current applied, typical life as function of ambient temperature is listed below.</p> <table border="1"> <thead> <tr> <th>Temperature</th> <th>Life (hours max.)</th> </tr> </thead> <tbody> <tr> <td>+85°C</td> <td>6,500 hours max.</td> </tr> <tr> <td>+65°C</td> <td>23,800 hours max.</td> </tr> <tr> <td>+45°C</td> <td>124,700 hours max.</td> </tr> </tbody> </table> <p>Capacitance change: \leq 30% from initial measurement ESR change : \leq 300% of initial specified limit Leakage current : \leq initial specified limit</p>	Temperature	Life (hours max.)	+85°C	6,500 hours max.	+65°C	23,800 hours max.	+45°C	124,700 hours max.																																							
Temperature	Life (hours max.)																																															
+85°C	6,500 hours max.																																															
+65°C	23,800 hours max.																																															
+45°C	124,700 hours max.																																															
Shelf Life	<p>The following specifications shall be satisfied when the capacitors are restored to +25°C after exposing them for 500 hours at +85°C without voltage applied. The rated voltage shall be applied to the capacitors for a minimum of 30 minutes, at least 24 hours and not more than 48 hours before the measurements.</p> <p>Capacitance change: \leq 20% from initial measurement ESR change : \leq 200% of initial specified limit Leakage current : \leq initial specified limit</p>																																															
Vibration Rating	10-55Hz, 10g sinusoidal in three axes, 2 hours per axis.																																															
Maximum Tightening Torque	<table border="1"> <thead> <tr> <th>Terminal Code</th> <th>HP</th> <th>HL</th> <th>CD</th> <th>CP</th> <th>CH</th> <th>CA</th> <th>CS</th> </tr> </thead> <tbody> <tr> <td>Thread Size</td> <td>10-32 NF-2B</td> <td>M5x0.8-6H</td> <td></td> <td>1/4-28 NF-2B</td> <td></td> <td>M6x1-6H</td> <td></td> </tr> <tr> <td>3 Threads Engaged</td> <td colspan="3">2.0 N·m (18.0 in·lb)</td> <td colspan="4">4.0 N·m (35.0 in·lb)</td> </tr> <tr> <td>6 Threads Engaged</td> <td colspan="3">2.8 N·m (25.0 in·lb)</td> <td colspan="4">6.2 N·m (55.0 in·lb)</td> </tr> </tbody> </table>	Terminal Code	HP	HL	CD	CP	CH	CA	CS	Thread Size	10-32 NF-2B	M5x0.8-6H		1/4-28 NF-2B		M6x1-6H		3 Threads Engaged	2.0 N·m (18.0 in·lb)			4.0 N·m (35.0 in·lb)				6 Threads Engaged	2.8 N·m (25.0 in·lb)			6.2 N·m (55.0 in·lb)																		
Terminal Code	HP	HL	CD	CP	CH	CA	CS																																									
Thread Size	10-32 NF-2B	M5x0.8-6H		1/4-28 NF-2B		M6x1-6H																																										
3 Threads Engaged	2.0 N·m (18.0 in·lb)			4.0 N·m (35.0 in·lb)																																												
6 Threads Engaged	2.8 N·m (25.0 in·lb)			6.2 N·m (55.0 in·lb)																																												
Typical Inductance (nH) at 1MHz	<table border="1"> <thead> <tr> <th rowspan="2">Case Diameter (mm)</th> <th colspan="7">Terminal Code</th> </tr> <tr> <th>HP</th> <th>HL</th> <th>CD</th> <th>CP</th> <th>CH</th> <th>CA</th> <th>CS</th> </tr> </thead> <tbody> <tr> <td>ϕ50.8</td> <td>—</td> <td>—</td> <td>NA</td> <td>NA</td> <td>NA</td> <td>NA</td> <td>NA</td> </tr> <tr> <td>ϕ63.5</td> <td>—</td> <td>—</td> <td>—</td> <td>—</td> <td>—</td> <td>—</td> <td>—</td> </tr> <tr> <td>ϕ76.2</td> <td>30</td> <td>30</td> <td>25</td> <td>20</td> <td>25</td> <td>20</td> <td>25</td> </tr> <tr> <td>ϕ89.0</td> <td>30</td> <td>30</td> <td>25</td> <td>20</td> <td>25</td> <td>20</td> <td>25</td> </tr> </tbody> </table>	Case Diameter (mm)	Terminal Code							HP	HL	CD	CP	CH	CA	CS	ϕ 50.8	—	—	NA	NA	NA	NA	NA	ϕ 63.5	—	—	—	—	—	—	—	ϕ 76.2	30	30	25	20	25	20	25	ϕ 89.0	30	30	25	20	25	20	25
Case Diameter (mm)	Terminal Code																																															
	HP	HL	CD	CP	CH	CA	CS																																									
ϕ 50.8	—	—	NA	NA	NA	NA	NA																																									
ϕ 63.5	—	—	—	—	—	—	—																																									
ϕ 76.2	30	30	25	20	25	20	25																																									
ϕ 89.0	30	30	25	20	25	20	25																																									
Custom Designs	Custom CV values per case size and termination type may be available upon request. Contact appropriate representative with specific requirements.																																															

U37F Series

U37F Useful Life

Useful Life: 6,500 Hours at +85°C

The life expectancy of a capacitor is shown as a function of ambient temperature and ripple current load.

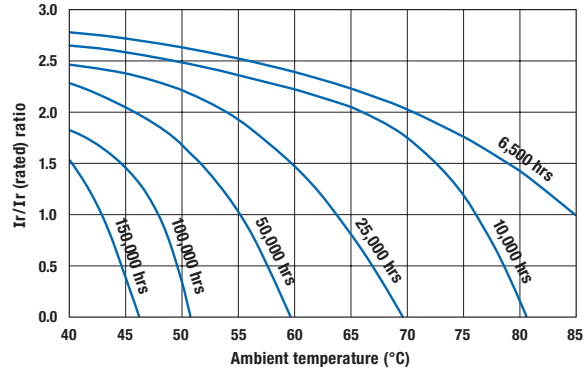
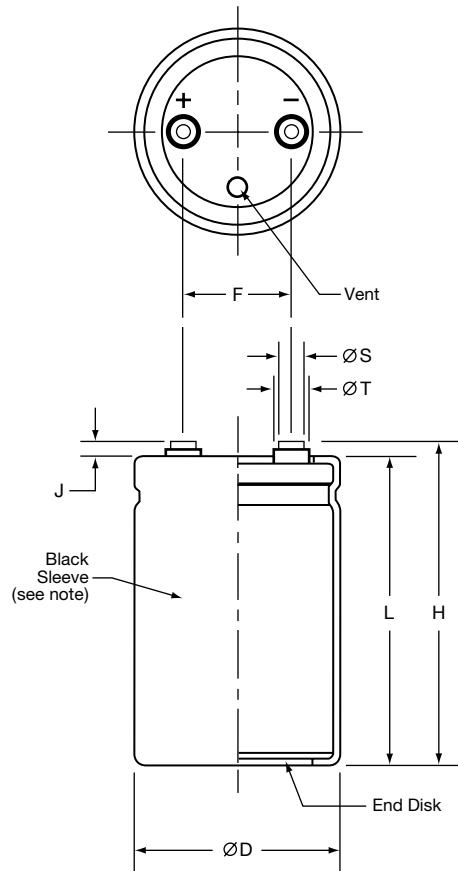

Diagram of Dimensions - Screw Terminals

Large Can/Screw Terminals

Unit: mm (inches)



Case Dimensions and Standard Box Quantities

Case Size Code	ØD +2.0 (0.080)	L ±1.0 (0.040)	F ±0.25 (0.010)	Standard Box Quantity
CB7 CD0	50.8 (2.000)	117 (4.625) 130 (5.125)	22.2 (0.875)	49
D92 DA5 DB7 DD0 DE3	63.5 (2.500)	92 (3.625) 105 (4.125) 117 (4.625) 130 (5.125) 143 (5.625)	28.6 (1.125)	20
E92 EA5 EB7 EE3 EJ1 EM9	76.2 (3.000)	92 (3.625) 105 (4.125) 117 (4.625) 143 (5.625) 181 (7.125) 219 (8.625)	31.8 (1.250)	16 9
F92 FA5 FB7 FE3 FF5 FK0 FM9	89.0 (3.500)	92 (3.625) 105 (4.125) 117 (4.625) 143 (5.625) 155 (6.125) 190 (7.500) 219 (8.625)	31.8 (1.250)	5

Note:

In some cases, the color of the sleeve may change slightly due to the operating conditions, however, the discoloration will not impair capacitor function.

Terminal Specifications

Terminal Code	Available Case Diameter		Thread Size	Minimum Thread Depth	J ±0.5 (0.020)	H ±2.0 (0.080)	ØS ±0.25 (0.010)	ØT ±0.25 (0.010)
	ØD Code	ØD mm (inches)						
HP	C	50.8 (2.000)	10-32 NF-2B	9.5 (0.375)	6.4 (0.250)	L+J	8.0 (0.313)	11.1 (0.438)
HL	C	50.8 (2.000)	M5x0.8-6H	9.5 (0.375)	6.4 (0.250)	L+J	8.0 (0.313)	11.1 (0.438)
CD	D-E	63.5 - 76.2 (2.500 - 3.000)	M5x0.8-6H	8.5 (0.335)	5.0 (0.200)	L+J	13.0 (0.512)	18.8 (0.740)
CP	D-F	63.5 - 89.0 (2.500 - 3.500)	¼-28 NF-2B	8.7 (0.344)	2.4 (0.093)	L+J	17.5 (0.689)	—
CH	D-F	63.5 - 89.0 (2.500 - 3.500)	¼-28 NF-2B	11.9 (0.468)	6.4 (0.250)	L+J	17.5 (0.689)	—
CA	D-F	63.5 - 89.0 (2.500 - 3.500)	M6x1-6H	8.7 (0.344)	2.4 (0.093)	L+J	17.5 (0.689)	—
CS	D-F	63.5 - 89.0 (2.500 - 3.500)	M6x1-6H	11.9 (0.468)	6.4 (0.250)	L+J	17.5 (0.689)	—

Mounting Hardware is optional. Refer to hardware specifications on the following page.

U37F Series

Mounting Hardware - Screw Terminals

Type C: Three-Footed Clamp

Unit: mm (inches)

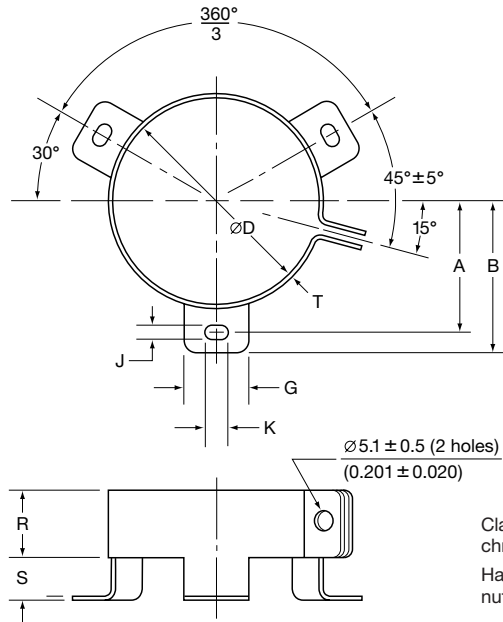

Clamp: Zinc with silver trivalent chromate post treatment.
Hardware: Screw, washer and hexagon nut included with each clamp.

Type C: Clamp Dimensions

Mounting Code	Case øD	A ±1.0 (0.040)	B ±1.0 (0.040)	G ±1.0 (0.040)	J ±0.5 (0.020)	K ±0.5 (0.020)	R ±1.0 (0.040)	S ±1.0 (0.040)	T ±0.5 (0.020)
C	50.8 (2.000)	31.8 (1.250)	36.5 (1.437)	13.3 (0.524)	4.5 (0.177)	7.1 (0.280)	19.1 (0.751)	9.5 (0.374)	0.8 (0.032)
C	63.5 (2.500)	38.1 (1.500)	42.9 (1.689)	13.3 (0.524)	4.5 (0.177)	7.1 (0.280)	19.1 (0.751)	9.5 (0.374)	0.8 (0.032)
C	76.2 (3.000)	44.5 (1.750)	49.2 (1.937)	13.3 (0.524)	4.5 (0.177)	7.1 (0.280)	19.1 (0.751)	9.5 (0.374)	1.0 (0.040)
C	89.0 (3.500)	50.8 (2.000)	56.5 (2.224)	16.0 (0.630)	4.5 (0.177)	8.0 (0.313)	21.0 (0.827)	9.0 (0.354)	1.0 (0.040)

Type S: Stud Mounting

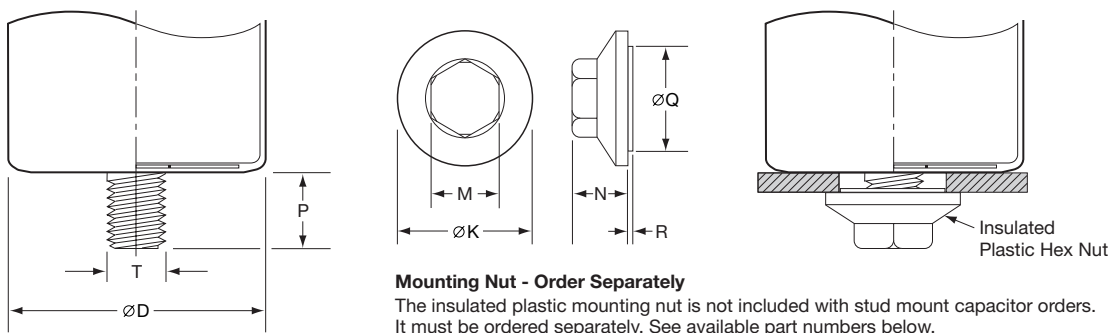

Type S: Stud Dimensions

Mounting Code	P ±1.0 (0.040)	T Thread Size
S	16.0 (0.630)	M12

Mounting Nut Dimensions

Part Number	øK ±2.0 (0.080)	M ±1.0 (0.040)	N ±1.0 (0.040)	øQ ±1.0 (0.040)	R ±1.0 (0.040)
50-8D	30.0 (1.181)	19.0 (0.748)	18.0 (0.709)	22.0 (0.866)	1.40 (0.055)
50-8E	38.0 (1.496)	19.0 (0.748)	18.0 (0.709)	30.0 (1.181)	1.40 (0.055)

U37F Series

Part Numbering System for U37F Series When ordering, always specify complete 18-field global part number.

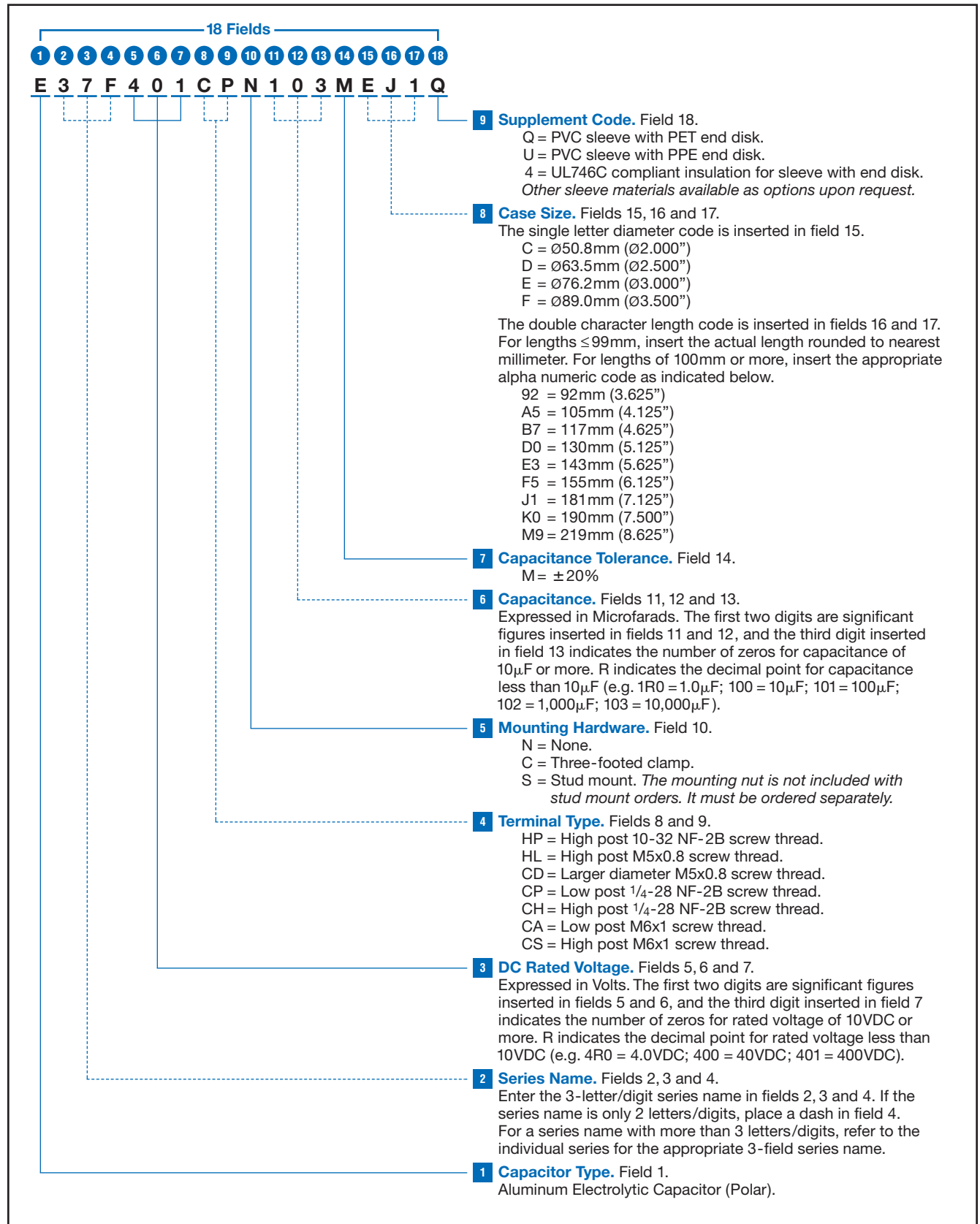

U37F Series

Standard Voltage Ratings - Screw Terminals

Rated Voltage (WVDC)	Capacitance (µF)	Global Part Number†	Nominal Case Size* D × L (mm)	Case Size Code	Maximum ESR (mΩ) at +25°C, 120Hz	Rated Ripple Current (A rms) at +85°C		
						120Hz	300Hz	>3kHz
350 Volts 400 Volts Surge	3,300	E37F351HPN332MCB7Q	50.8 × 117	CB7	28	10.8	12.9	15.1
	3,900	E37F351HPN392MCD0Q	50.8 × 130	CD0	23	12.2	14.6	17.0
	3,300	E37F351CPN332MD92Q	63.5 × 92	D92	28	11.2	13.4	15.6
	3,900	E37F351CPN392MDA5Q	63.5 × 105	DA5	23	12.7	15.2	17.7
	4,700	E37F351CPN472MDB7Q	63.5 × 117	DB7	19	14.5	17.4	20.3
	5,600	E37F351CPN562MDD0Q	63.5 × 130	DD0	16	16.4	19.7	22.9
	5,600	E37F351CPN562MDE3Q	63.5 × 143	DE3	16	17.0	20.4	23.7
	4,700	E37F351CPN472ME92Q	76.2 × 92	E92	20	14.5	17.4	20.2
	5,600	E37F351CPN562MEA5Q	76.2 × 105	EA5	17	16.5	19.8	23.1
	6,800	E37F351CPN682MEB7Q	76.2 × 117	EB7	14	18.9	22.6	26.4
	8,200	E37F351CPN822MEE3Q	76.2 × 143	EE3	12	22.2	26.7	31.1
	12,000	E37F351CPN123MEJ1Q	76.2 × 181	EJ1	8	29.4	35.2	41.1
	15,000	E37F351CPN153MEM9Q	76.2 × 219	EM9	6	35.4	42.5	49.6
	6,800	E37F351CPN682MF92Q	89 × 92	F92	14	19.1	22.9	26.7
	8,200	E37F351CPN822MFA5Q	89 × 105	FA5	12	21.8	26.2	30.5
	10,000	E37F351CPN103MFB7Q	89 × 117	FB7	10	25.0	30.0	35.0
	12,000	E37F351CPN123MFE3Q	89 × 143	FE3	8	29.3	35.2	41.1
	15,000	E37F351CPN153MFF5Q	89 × 155	FF5	6	33.8	40.5	47.3
18,000	E37F351CPN183MFK0Q	89 × 190	FK0	5	40.0	47.9	55.9	
22,000	E37F351CPN223MFM9Q	89 × 219	FM9	4	46.7	56.0	65.4	
400 Volts 450 Volts Surge	2,700	E37F401HPN272MCB7Q	50.8 × 117	CB7	30	10.4	12.5	14.6
	3,300	E37F401HPN332MCD0Q	50.8 × 130	CD0	26	11.6	13.9	16.2
	2,700	E37F401CPN272MD92Q	63.5 × 92	D92	30	10.7	12.9	15.0
	3,300	E37F401CPN332MDA5Q	63.5 × 105	DA5	25	12.3	14.7	17.2
	3,900	E37F401CPN392MDB7Q	63.5 × 117	DB7	21	13.8	16.5	19.3
	4,700	E37F401CPN472MDD0Q	63.5 × 130	DD0	19	15.3	18.3	21.4
	4,700	E37F401CPN472MDE3Q	63.5 × 143	DE3	17	16.8	20.1	23.5
	3,900	E37F401CPN392ME92Q	76.2 × 92	E92	21	14.3	17.2	20.0
	5,600	E37F401CPN562MEA5Q	76.2 × 105	EA5	17	16.4	19.6	22.9
	5,600	E37F401CPN562MEB7Q	76.2 × 117	EB7	15	18.4	22.0	25.7
	8,200	E37F401CPN822MEE3Q	76.2 × 143	EE3	12	22.3	26.8	31.3
	10,000	E37F401CPN103MEJ1Q	76.2 × 181	EJ1	9	28.2	33.8	39.5
	12,000	E37F401CPN123MEM9Q	76.2 × 219	EM9	7	34.0	40.8	47.6
	5,600	E37F401CPN562MF92Q	89 × 92	F92	15	18.6	22.3	26.1
	6,800	E37F401CPN682MFA5Q	89 × 105	FA5	12	21.2	25.5	29.7
	8,200	E37F401CPN822MFB7Q	89 × 117	FB7	11	23.8	28.6	33.4
	10,000	E37F401CPN103MFE3Q	89 × 143	FE3	8	28.9	34.7	40.5
	12,000	E37F401CPN123MFF5Q	89 × 155	FF5	7	31.4	37.7	44.0
15,000	E37F401CPN153MFK0Q	89 × 190	FK0	6	38.3	45.9	53.6	
18,000	E37F401CPN183MFM9Q	89 × 219	FM9	5	43.9	52.7	61.5	
420 Volts 470 Volts Surge	2,700	E37F421HPN272MCB7Q	50.8 × 117	CB7	34	9.8	11.7	13.7
	3,300	E37F421HPN332MCD0Q	50.8 × 130	CD0	28	11.2	13.4	15.7
	2,700	E37F421CPN272MD92Q	63.5 × 92	D92	34	10.1	12.1	14.1
	3,300	E37F421CPN332MDA5Q	63.5 × 105	DA5	28	11.7	14.0	16.3
	3,900	E37F421CPN392MDB7Q	63.5 × 117	DB7	23	13.2	15.8	18.5
	3,900	E37F421CPN392MDD0Q	63.5 × 130	DD0	23	13.7	16.4	19.1
	4,700	E37F421CPN472MDE3Q	63.5 × 143	DE3	19	15.5	18.6	21.8
	3,900	E37F421CPN392ME92Q	76.2 × 92	E92	24	13.2	15.8	18.4
	4,700	E37F421CPN472MEA5Q	76.2 × 105	EA5	20	15.1	18.1	21.1
	5,600	E37F421CPN562MEB7Q	76.2 × 117	EB7	17	17.1	20.5	24.0
	6,800	E37F421CPN682MEE3Q	76.2 × 143	EE3	14	20.2	24.3	28.3
	10,000	E37F421CPN103MEJ1Q	76.2 × 181	EJ1	10	26.8	32.2	37.5
	12,000	E37F421CPN123MEM9Q	76.2 × 219	EM9	8	31.7	38.0	44.4
	5,600	E37F421CPN562MF92Q	89 × 92	F92	17	17.3	20.8	24.2
	6,800	E37F421CPN682MFA5Q	89 × 105	FA5	14	19.9	23.8	27.8

† For terminal, mounting and construction options, refer to the part numbering system for descriptions and codes.

* Refer to diagram of dimensions for detailed case size specifications.

U37F Series

Standard Voltage Ratings - Screw Terminals

Rated Voltage (WVDC)	Capacitance (µF)	Global Part Number†	Nominal Case Size* D × L (mm)	Case Size Code	Maximum ESR (mΩ) at +25°C, 120Hz	Rated Ripple Current (A rms) at +85°C		
						120Hz	300Hz	>3kHz
420 Volts 470 Volts Surge	8,200	E37F421CPN822MFB7Q	89 × 117	FB7	12	22.7	27.2	31.7
	10,000	E37F421CPN103MFE3Q	89 × 143	FE3	10	26.8	32.1	37.5
	12,000	E37F421CPN123MFF5Q	89 × 155	FF5	8	30.3	36.3	42.4
	15,000	E37F421CPN153MFK0Q	89 × 190	FK0	6	36.5	43.8	51.1
	18,000	E37F421CPN183MFM9Q	89 × 219	FM9	5	42.2	50.7	59.1
450 Volts 500 Volts Surge	2,700	E37F451HPN272MCB7Q	50.8 × 117	CB7	34	9.8	11.7	13.7
	2,700	E37F451HPN272MCD0Q	50.8 × 130	CD0	34	10.1	12.1	14.2
	2,200	E37F451CPN222MD92Q	63.5 × 92	D92	42	9.1	10.9	12.8
	2,700	E37F451CPN272MDA5Q	63.5 × 105	DA5	34	10.5	12.7	14.8
	3,300	E37F451CPN332MDB7Q	63.5 × 117	DB7	28	12.1	14.6	17.0
	3,900	E37F451CPN392MDD0Q	63.5 × 130	DD0	23	13.7	16.4	19.1
	4,700	E37F451CPN472MDE3Q	63.5 × 143	DE3	19	15.5	18.6	21.8
	3,900	E37F451CPN392ME92Q	76.2 × 92	E92	24	13.2	15.8	18.4
	4,700	E37F451CPN472MEA5Q	76.2 × 105	EA5	20	15.1	18.1	21.1
	5,600	E37F451CPN562MEB7Q	76.2 × 117	EB7	17	17.1	20.5	24.0
	6,800	E37F451CPN682MEE3Q	76.2 × 143	EE3	14	20.2	24.3	28.3
	8,200	E37F451CPN822MEJ1Q	76.2 × 181	EJ1	12	24.3	29.1	34.0
	12,000	E37F451CPN123MEM9Q	76.2 × 219	EM9	8	31.7	38.0	44.4
	5,600	E37F451CPN562MF92Q	89 × 92	F92	17	17.3	20.8	24.2
	6,800	E37F451CPN682MFA5Q	89 × 105	FA5	14	19.9	23.8	27.8
	6,800	E37F451CPN682MFB7Q	89 × 117	FB7	14	20.6	24.8	28.9
	8,200	E37F451CPN822MFE3Q	89 × 143	FE3	12	24.3	29.1	34.0
	12,000	E37F451CPN123MFF5Q	89 × 155	FF5	8	30.2	36.3	42.3
	15,000	E37F451CPN153MFK0Q	89 × 190	FK0	6	36.5	43.8	51.1
	15,000	E37F451CPN153MFM9Q	89 × 219	FM9	6	38.6	46.3	54.0
500 Volts 550 Volts Surge	1,500	E37F501HPN152MCB7Q	50.8 × 117	CB7	63	7.2	8.6	10.1
	1,800	E37F501HPN182MCD0Q	50.8 × 130	CD0	55	8.0	9.6	11.2
	1,800	E37F501CPN182MD92Q	63.5 × 92	D92	52	8.2	9.8	11.5
	2,200	E37F501CPN222MDA5Q	63.5 × 105	DA5	43	9.4	11.2	13.1
	2,700	E37F501CPN272MDB7Q	63.5 × 117	DB7	37	10.5	12.6	14.7
	3,300	E37F501CPN332MDD0Q	63.5 × 130	DD0	32	11.7	14.0	16.3
	3,300	E37F501CPN332MDE3Q	63.5 × 143	DE3	29	12.8	15.4	17.9
	2,700	E37F501CPN272ME92Q	76.2 × 92	E92	36	10.9	13.1	15.3
	3,300	E37F501CPN332MEA5Q	76.2 × 105	EA5	30	12.5	15.0	17.5
	3,900	E37F501CPN392MEB7Q	76.2 × 117	EB7	25	14.0	16.8	19.6
	5,600	E37F501CPN562MEE3Q	76.2 × 143	EE3	20	17.1	20.5	23.9
	6,800	E37F501CPN682MEJ1Q	76.2 × 181	EJ1	15	21.5	25.8	30.1
	8,200	E37F501CPN822MEM9Q	76.2 × 219	EM9	12	26.0	31.2	36.3
	3,900	E37F501CPN392MF92Q	89 × 92	F92	25	14.2	17.1	19.9
	4,700	E37F501CPN472MFA5Q	89 × 105	FA5	21	16.2	19.5	22.7
	5,600	E37F501CPN562MFB7Q	89 × 117	FB7	18	18.2	21.8	25.5
	6,800	E37F501CPN682MFE3Q	89 × 143	FE3	14	22.1	26.5	30.9
	8,200	E37F501CPN822MFF5Q	89 × 155	FF5	13	24.0	28.8	33.6
	10,000	E37F501CPN103MFK0Q	89 × 190	FK0	10	29.2	35.1	40.9
	12,000	E37F501CPN123MFM9Q	89 × 219	FM9	8	33.5	40.2	46.9

†For terminal, mounting and construction options, refer to the part numbering system for descriptions and codes.

*Refer to diagram of dimensions for detailed case size specifications.

U37L Series



- Large Can
- Screw Terminals
- High Ripple
- 350 to 500VDC Ratings
- RoHS Compliant
- +85°C Maximum Temperature
- 10,000 Hours Lifetime at +85°C
- Up to 175,000 Hours Useful Life

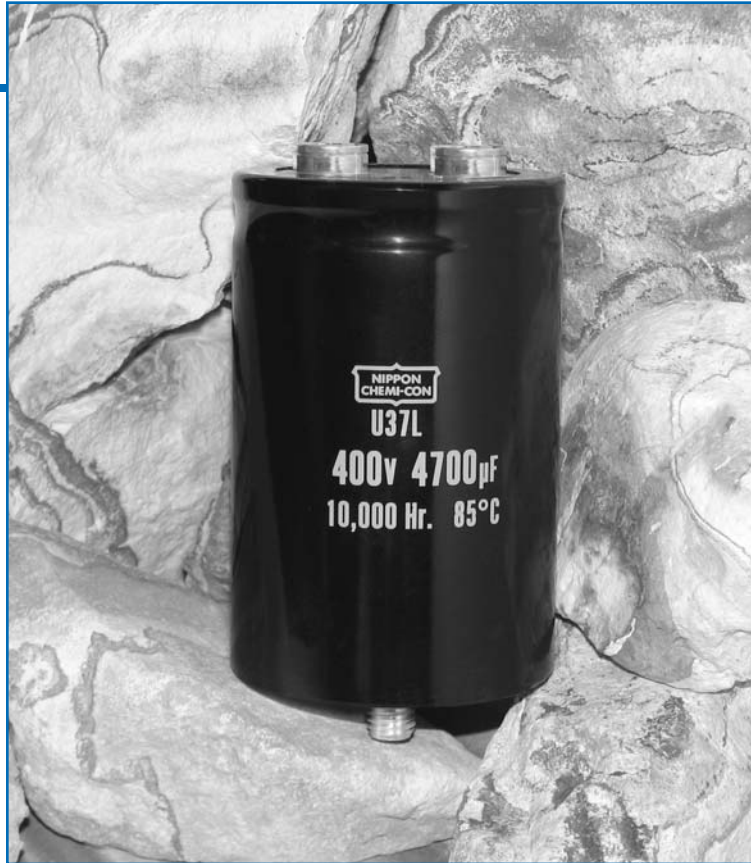

The U37L series is a longer life version of the U37 grade series and is specifically designed to provide the ripple current capability and long life required for high reliability inverter applications. The U37L has an endurance rating of 10,000 hours at +85°C with the rated ripple current applied. The useful life can exceed 175,000 hours at +40°C and 2x the ripple current. These capacitors are available in a variety of high current English or Metric thread terminals. Mounting options include a three-footed clamp or bottom threaded stud. Custom designs are also available.

Summary of Specifications

- Screw terminals: high and low post, English and Metric thread.
- Capacitance range: 1,500 to 18,000µF.
- Voltage range: 350 to 500VDC.
- Category temperature range: -40°C to +85°C.
- Leakage current: 0.02CV(µA) or 5mA, whichever is smaller, after 5 minutes at +25°C.
- Standard capacitance tolerance: ±20%
- Nominal case size (D × L): D = 50.8mm (2.000") to 89mm (3.500"); L = 92mm (3.625") to 219mm (8.625").
- Rated lifetime: 10,000 hours at +85°C with rated ripple current applied.

U37L Series

U37L Specifications - Screw Terminals

Item	Characteristics																																															
Category Temperature Range	- 40 to +85°C																																															
Rated Voltage Range	350 to 500VDC																																															
Capacitance Range	1,500 to 18,000µF at +25°C, 120Hz																																															
Capacitance Tolerance	± 20% (M) at +25°C, 120Hz																																															
Leakage Current	I = 0.02CV (µA) or 5mA, whichever is smaller, after 5 minutes at +25°C. Where I = Max. leakage current (µA), C = Nominal capacitance (µF) and V = Rated voltage (V)																																															
Rated Ripple Current Multipliers	<p>Ambient Temperature (°C)</p> <table border="1"> <tr> <td>+45°C</td> <td>+65°C</td> <td>+85°C</td> </tr> <tr> <td>2.82</td> <td>1.73</td> <td>1.00</td> </tr> </table> <p>Frequency (Hz)</p> <table border="1"> <tr> <td>DC Rated Voltage</td> <td>50Hz</td> <td>120Hz</td> <td>300Hz</td> <td>1kHz</td> <td>3kHz</td> <td>10kHz</td> </tr> <tr> <td>350-500V</td> <td>0.80</td> <td>1.00</td> <td>1.20</td> <td>1.30</td> <td>1.40</td> <td>1.41</td> </tr> </table> <p>To determine maximum ripple current at a specified temperature and frequency, use the appropriate multiplier shown.</p>	+45°C	+65°C	+85°C	2.82	1.73	1.00	DC Rated Voltage	50Hz	120Hz	300Hz	1kHz	3kHz	10kHz	350-500V	0.80	1.00	1.20	1.30	1.40	1.41																											
+45°C	+65°C	+85°C																																														
2.82	1.73	1.00																																														
DC Rated Voltage	50Hz	120Hz	300Hz	1kHz	3kHz	10kHz																																										
350-500V	0.80	1.00	1.20	1.30	1.40	1.41																																										
Endurance (Load Life)	<p>The following specifications shall be satisfied when the capacitors are restored to +25°C after subjecting them to DC voltage for 10,000 hours at +85°C with the rated ripple current applied. The sum of the DC voltage and peak AC voltage must not exceed the full rated voltage of the capacitors.</p> <p>Capacitance change: ≤ 20% from initial measurement ESR change : ≤ 200% of initial specified limit Leakage current : ≤ initial specified limit</p>																																															
Useful Life	<p>With specified standard voltage and ripple current applied, typical life as function of ambient temperature is listed below.</p> <table border="1"> <tr> <td>+85°C</td> <td>13,000 hours max.</td> <td rowspan="3"> Capacitance change: ≤ 30% from initial measurement ESR change : ≤ 300% of initial specified limit Leakage current : ≤ initial specified limit </td> </tr> <tr> <td>+65°C</td> <td>47,700 hours max.</td> </tr> <tr> <td>+45°C</td> <td>175,000 hours max.</td> </tr> </table>	+85°C	13,000 hours max.	Capacitance change: ≤ 30% from initial measurement ESR change : ≤ 300% of initial specified limit Leakage current : ≤ initial specified limit	+65°C	47,700 hours max.	+45°C	175,000 hours max.																																								
+85°C	13,000 hours max.	Capacitance change: ≤ 30% from initial measurement ESR change : ≤ 300% of initial specified limit Leakage current : ≤ initial specified limit																																														
+65°C	47,700 hours max.																																															
+45°C	175,000 hours max.																																															
Shelf Life	<p>The following specifications shall be satisfied when the capacitors are restored to +25°C after exposing them for 500 hours at +85°C without voltage applied. The rated voltage shall be applied to the capacitors for a minimum of 30 minutes, at least 24 hours and not more than 48 hours before the measurements.</p> <p>Capacitance change: ≤ 20% from initial measurement ESR change : ≤ 200% of initial specified limit Leakage current : ≤ initial specified limit</p>																																															
Vibration Rating	10-55Hz, 10g sinusoidal in three axes, 2 hours per axis.																																															
Maximum Tightening Torque	<table border="1"> <tr> <td>Terminal Code</td> <td>HP</td> <td>HL</td> <td>CD</td> <td>CP</td> <td>CH</td> <td>CA</td> <td>CS</td> </tr> <tr> <td>Thread Size</td> <td>10-32 NF-2B</td> <td>M5x0.8-6H</td> <td></td> <td>¼-28 NF-2B</td> <td></td> <td>M6x1-6H</td> <td></td> </tr> <tr> <td>3 Threads Engaged</td> <td colspan="3">2.0 N·m (18.0 in·lb)</td> <td colspan="4">4.0 N·m (35.0 in·lb)</td> </tr> <tr> <td>6 Threads Engaged</td> <td colspan="3">2.8 N·m (25.0 in·lb)</td> <td colspan="4">6.2 N·m (55.0 in·lb)</td> </tr> </table>	Terminal Code	HP	HL	CD	CP	CH	CA	CS	Thread Size	10-32 NF-2B	M5x0.8-6H		¼-28 NF-2B		M6x1-6H		3 Threads Engaged	2.0 N·m (18.0 in·lb)			4.0 N·m (35.0 in·lb)				6 Threads Engaged	2.8 N·m (25.0 in·lb)			6.2 N·m (55.0 in·lb)																		
Terminal Code	HP	HL	CD	CP	CH	CA	CS																																									
Thread Size	10-32 NF-2B	M5x0.8-6H		¼-28 NF-2B		M6x1-6H																																										
3 Threads Engaged	2.0 N·m (18.0 in·lb)			4.0 N·m (35.0 in·lb)																																												
6 Threads Engaged	2.8 N·m (25.0 in·lb)			6.2 N·m (55.0 in·lb)																																												
Typical Inductance (nH) at 1MHz	<table border="1"> <tr> <td rowspan="2">Case Diameter (mm)</td> <td colspan="7">Terminal Code</td> </tr> <tr> <td>HP</td> <td>HL</td> <td>CD</td> <td>CP</td> <td>CH</td> <td>CA</td> <td>CS</td> </tr> <tr> <td>Ø50.8</td> <td>—</td> <td>—</td> <td>NA</td> <td>NA</td> <td>NA</td> <td>NA</td> <td>NA</td> </tr> <tr> <td>Ø63.5</td> <td>—</td> <td>—</td> <td>—</td> <td>—</td> <td>—</td> <td>—</td> <td>—</td> </tr> <tr> <td>Ø76.2</td> <td>30</td> <td>30</td> <td>25</td> <td>20</td> <td>25</td> <td>20</td> <td>25</td> </tr> <tr> <td>Ø89.0</td> <td>30</td> <td>30</td> <td>25</td> <td>20</td> <td>25</td> <td>20</td> <td>25</td> </tr> </table>	Case Diameter (mm)	Terminal Code							HP	HL	CD	CP	CH	CA	CS	Ø50.8	—	—	NA	NA	NA	NA	NA	Ø63.5	—	—	—	—	—	—	—	Ø76.2	30	30	25	20	25	20	25	Ø89.0	30	30	25	20	25	20	25
Case Diameter (mm)	Terminal Code																																															
	HP	HL	CD	CP	CH	CA	CS																																									
Ø50.8	—	—	NA	NA	NA	NA	NA																																									
Ø63.5	—	—	—	—	—	—	—																																									
Ø76.2	30	30	25	20	25	20	25																																									
Ø89.0	30	30	25	20	25	20	25																																									
Custom Designs	Custom CV values per case size and termination type may be available upon request. Contact appropriate representative with specific requirements.																																															

U37L
SCREW MOUNT 85°C

U37L Series

U37L Useful Life

Useful Life: 13,000 Hours at +85°C

The life expectancy of a capacitor is shown as a function of ambient temperature and ripple current load.

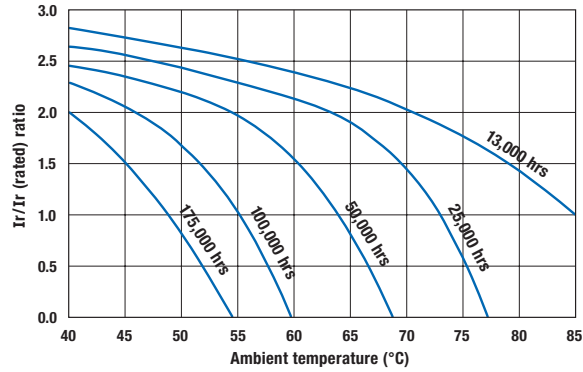
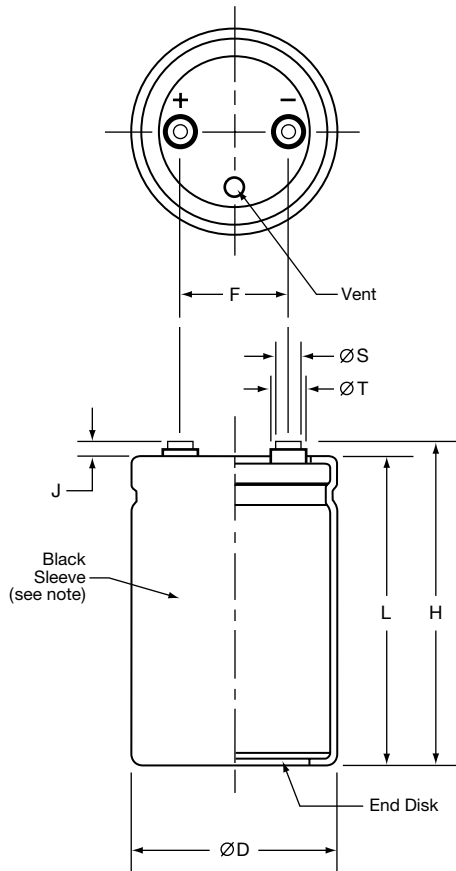

Diagram of Dimensions - Screw Terminals

Large Can/Screw Terminals

Unit: mm (inches)



Case Dimensions and Standard Box Quantities

Case Size Code	øD +2.0 (0.080)	L ±1.0 (0.040)	F ±0.25 (0.010)	Standard Box Quantity
CB7 CD0	50.8 (2.000)	117 (4.625) 130 (5.125)	22.2 (0.875)	49
D92 DA5 DB7 DD0 DE3	63.5 (2.500)	92 (3.625) 105 (4.125) 117 (4.625) 130 (5.125) 143 (5.625)	28.6 (1.125)	20
E92 EA5 EB7 EE3 EJ1 EM9	76.2 (3.000)	92 (3.625) 105 (4.125) 117 (4.625) 143 (5.625) 181 (7.125) 219 (8.625)	31.8 (1.250)	16 9
F92 FA5 FB7 FE3 FF5 FK0 FM9	89.0 (3.500)	92 (3.625) 105 (4.125) 117 (4.625) 143 (5.625) 155 (6.125) 190 (7.500) 219 (8.625)	31.8 (1.250)	5

Note:
In some cases, the color of the sleeve may change slightly due to the operating conditions, however, the discoloration will not impair capacitor function.

Terminal Specifications

Terminal Code	Available Case Diameter		Thread Size	Minimum Thread Depth	J ±0.5 (0.020)	H ±2.0 (0.080)	øS ±0.25 (0.010)	øT ±0.25 (0.010)
	øD Code	øD mm (inches)						
HP	C	50.8 (2.000)	10-32 NF-2B	9.5 (0.375)	6.4 (0.250)	L+J	8.0 (0.313)	11.1 (0.438)
HL	C	50.8 (2.000)	M5x0.8-6H	9.5 (0.375)	6.4 (0.250)	L+J	8.0 (0.313)	11.1 (0.438)
CD	D-E	63.5 – 76.2 (2.500 – 3.000)	M5x0.8-6H	8.5 (0.335)	5.0 (0.200)	L+J	13.0 (0.512)	18.8 (0.740)
CP	D-F	63.5 – 89.0 (2.500 – 3.500)	1/4 - 28 NF-2B	8.7 (0.344)	2.4 (0.093)	L+J	17.5 (0.689)	—
CH	D-F	63.5 – 89.0 (2.500 – 3.500)	1/4 - 28 NF-2B	11.9 (0.468)	6.4 (0.250)	L+J	17.5 (0.689)	—
CA	D-F	63.5 – 89.0 (2.500 – 3.500)	M6x1-6H	8.7 (0.344)	2.4 (0.093)	L+J	17.5 (0.689)	—
CS	D-F	63.5 – 89.0 (2.500 – 3.500)	M6x1-6H	11.9 (0.468)	6.4 (0.250)	L+J	17.5 (0.689)	—

Mounting Hardware is optional. Refer to hardware specifications on the following page.

U37L Series

Part Numbering System for U37L Series When ordering, always specify complete 18-field global part number.

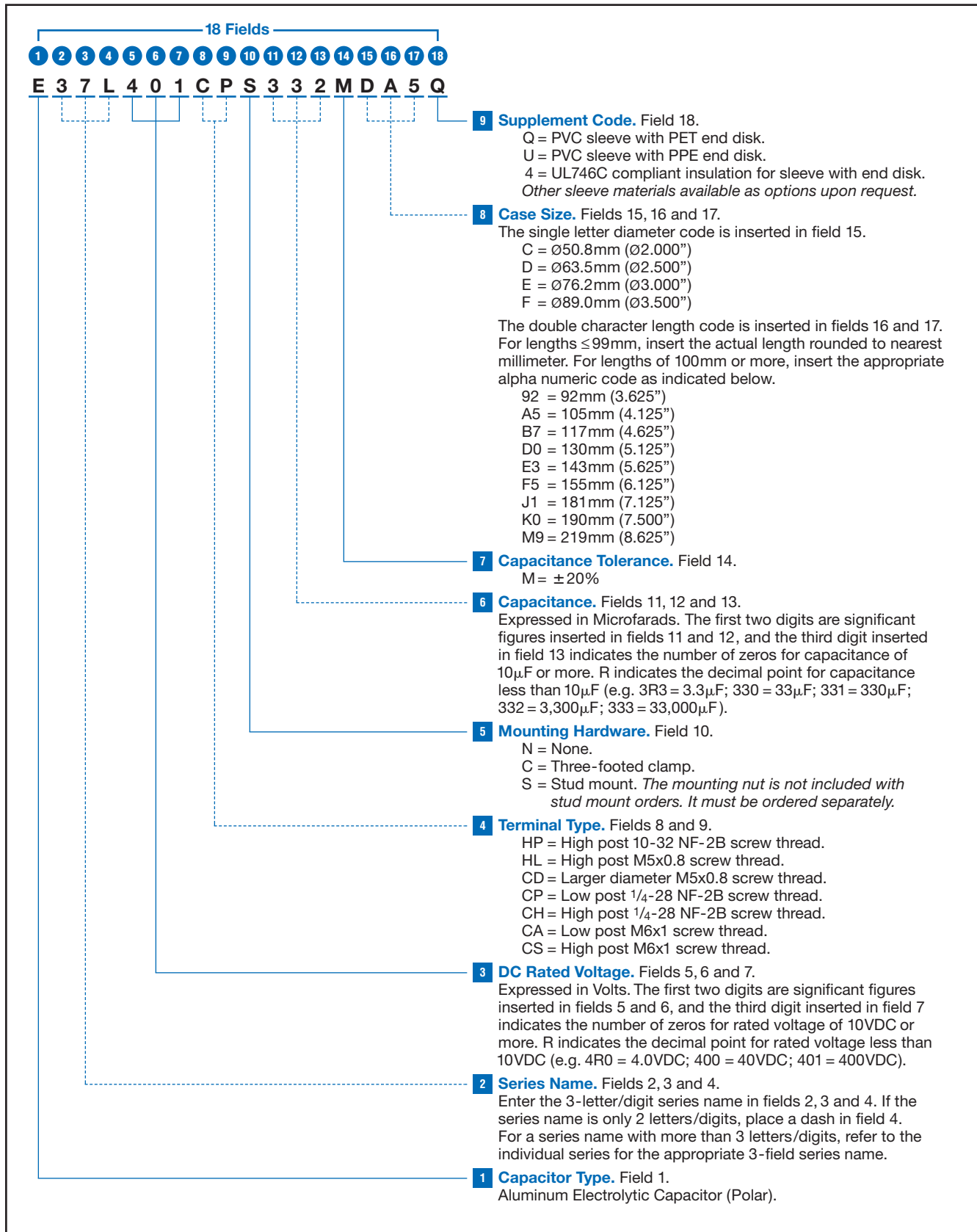

U37L Series

Standard Voltage Ratings - Screw Terminals

Rated Voltage (WVDC)	Capacitance (µF)	Global Part Number†	Nominal Case Size* D × L (mm)	Case Size Code	Maximum ESR (mΩ) at +25°C, 120Hz	Rated Ripple Current (A rms) at +85°C		
						120Hz	300Hz	>3kHz
350 Volts 400 Volts Surge	3,300	E37L351HPN332MCB7Q	50.8 × 117	CB7	29	10.6	12.7	14.8
	3,300	E37L351HPN332MCD0Q	50.8 × 130	CD0	29	11.0	13.1	15.3
	3,300	E37L351CPN332MD92Q	63.5 × 92	D92	30	10.7	12.8	15.0
	3,900	E37L351CPN392MDA5Q	63.5 × 105	DA5	26	12.2	14.6	17.0
	3,900	E37L351CPN392MDB7Q	63.5 × 117	DB7	26	12.6	15.2	17.7
	4,700	E37L351CPN472MDD0Q	63.5 × 130	DD0	21	14.4	17.3	20.2
	5,600	E37L351CPN562MDE3Q	63.5 × 143	DE3	18	16.3	19.5	22.8
	4,700	E37L351CPN472ME92Q	76.2 × 92	E92	22	13.9	16.7	19.5
	5,600	E37L351CPN562MEA5Q	76.2 × 105	EA5	18	15.8	19.0	22.1
	6,800	E37L351CPN682MEB7Q	76.2 × 117	EB7	15	18.1	21.7	25.4
	8,200	E37L351CPN822MEE3Q	76.2 × 143	EE3	13	21.3	25.6	29.9
	12,000	E37L351CPN123MEJ1Q	76.2 × 181	EJ1	9	28.2	33.9	39.5
	15,000	E37L351CPN153MEM9Q	76.2 × 219	EM9	7	34.0	40.8	47.6
	6,800	E37L351CPN682MF92Q	89 × 92	F92	15	18.3	22.0	25.6
	8,200	E37L351CPN822MFA5Q	89 × 105	FA5	13	21.0	25.2	29.3
	8,200	E37L351CPN822MFB7Q	89 × 117	FB7	13	21.8	26.1	30.5
	12,000	E37L351CPN123MFE3Q	89 × 143	FE3	9	28.2	33.8	39.5
	12,000	E37L351CPN123MFF5Q	89 × 155	FF5	9	29.0	34.8	40.6
15,000	E37L351CPN153MFK0Q	89 × 190	FK0	7	35.0	42.0	49.1	
18,000	E37L351CPN183MFM9Q	89 × 219	FM9	6	41.1	49.4	57.6	
400 Volts 450 Volts Surge	2,700	E37L401HPN272MCB7Q	50.8 × 117	CB7	35	9.5	11.5	13.4
	3,300	E37L401HPN332MCD0Q	50.8 × 130	CD0	29	11.0	13.1	15.3
	2,700	E37L401CPN272MD92Q	63.5 × 92	D92	37	9.7	11.6	13.6
	3,300	E37L401CPN332MDA5Q	63.5 × 105	DA5	30	11.2	13.4	15.7
	3,900	E37L401CPN392MDB7Q	63.5 × 117	DB7	26	12.6	15.2	17.7
	3,900	E37L401CPN392MDD0Q	63.5 × 130	DD0	26	13.1	15.7	18.4
	4,700	E37L401CPN472MDE3Q	63.5 × 143	DE3	21	14.9	17.9	20.9
	3,900	E37L401CPN392ME92Q	76.2 × 92	E92	27	12.7	15.2	17.7
	4,700	E37L401CPN472MEA5Q	76.2 × 105	EA5	22	14.5	17.4	20.3
	5,600	E37L401CPN562MEB7Q	76.2 × 117	EB7	18	16.4	19.7	23.0
	6,800	E37L401CPN682MEE3Q	76.2 × 143	EE3	15	19.4	23.3	27.2
	10,000	E37L401CPN103MEJ1Q	76.2 × 181	EJ1	10	25.8	30.9	36.1
	12,000	E37L401CPN123MEM9Q	76.2 × 219	EM9	9	30.4	36.5	42.6
	5,600	E37L401CPN562MF92Q	89 × 92	F92	18	16.6	20.0	23.3
	6,800	E37L401CPN682MFA5Q	89 × 105	FA5	15	19.1	22.9	26.7
	8,200	E37L401CPN822MFB7Q	89 × 117	FB7	13	21.8	26.1	30.5
	10,000	E37L401CPN103MFE3Q	89 × 143	FE3	10	25.7	30.9	36.0
	12,000	E37L401CPN123MFF5Q	89 × 155	FF5	9	29.0	34.8	40.6
15,000	E37L401CPN153MFK0Q	89 × 190	FK0	7	35.0	42.0	49.1	
18,000	E37L401CPN183MFM9Q	89 × 219	FM9	6	40.6	48.7	56.8	
420 Volts 470 Volts Surge	2,700	E37L421HPN272MCB7Q	50.8 × 117	CB7	35	9.5	11.5	13.4
	2,900	E37L421HPN292MCD0Q	50.8 × 130	CD0	33	10.3	12.3	14.4
	2,200	E37L421CPN222MD92Q	63.5 × 92	D92	45	8.7	10.5	12.2
	2,700	E37L421CPN272MDA5Q	63.5 × 105	DA5	37	10.1	12.1	14.2
	3,300	E37L421CPN332MDB7Q	63.5 × 117	DB7	30	11.6	14.0	16.3
	3,900	E37L421CPN392MDD0Q	63.5 × 130	DD0	26	13.1	15.7	18.4
	4,700	E37L421CPN472MDE3Q	63.5 × 143	DE3	21	14.9	17.9	20.9
	3,900	E37L421CPN392ME92Q	76.2 × 92	E92	27	12.7	15.2	17.7
	4,700	E37L421CPN472MEA5Q	76.2 × 105	EA5	22	14.5	17.4	20.3
	5,600	E37L421CPN562MEB7Q	76.2 × 117	EB7	18	16.4	19.7	23.0
	6,800	E37L421CPN682MEE3Q	76.2 × 143	EE3	15	19.4	23.3	27.2
	8,200	E37L421CPN822MEJ1Q	76.2 × 181	EJ1	13	23.3	28.0	32.7
	12,000	E37L421CPN123MEM9Q	76.2 × 219	EM9	9	30.4	36.5	42.6
	5,600	E37L421CPN562MF92Q	89 × 92	F92	18	16.6	20.0	23.3
	6,800	E37L421CPN682MFA5Q	89 × 105	FA5	15	19.1	22.9	26.7

†For terminal, mounting and construction options, refer to the part numbering system for descriptions and codes.

* Refer to diagram of dimensions for detailed case size specifications.

U37L Series

Standard Voltage Ratings - Screw Terminals

Rated Voltage (WVDC)	Capacitance (µF)	Global Part Number†	Nominal Case Size* D × L (mm)	Case Size Code	Maximum ESR (mΩ) at +25°C, 120Hz	Rated Ripple Current (A rms) at +85°C		
						120Hz	300Hz	>3kHz
420 Volts 470 Volts Surge	6,800	E37L421CPN682MFB7Q	89 × 117	FB7	15	19.8	23.8	27.8
	10,000	E37L421CPN103MFE3Q	89 × 143	FE3	10	25.7	30.9	36.0
	10,000	E37L421CPN103MFF5Q	89 × 155	FF5	10	26.5	31.8	37.1
	12,000	E37L421CPN123MFK0Q	89 × 190	FK0	9	31.3	37.6	43.9
	15,000	E37L421CPN153MFM9Q	89 × 219	FM9	7	37.0	44.5	51.9
450 Volts 500 Volts Surge	2,200	E37L451HPN222MCB7Q	50.8 × 117	CB7	43	8.6	10.3	12.1
	2,200	E37L451HPN222MCD0Q	50.8 × 130	CD0	43	8.9	10.7	12.5
	2,200	E37L451CPN222MD92Q	63.5 × 92	D92	45	8.7	10.5	12.2
	2,200	E37L451CPN222MDA5Q	63.5 × 105	DA5	45	9.1	11.0	12.8
	2,700	E37L451CPN272MDB7Q	63.5 × 117	DB7	37	10.5	12.6	14.7
	3,300	E37L451CPN332MDD0Q	63.5 × 130	DD0	30	12.1	14.5	16.9
	3,900	E37L451CPN392MDE3Q	63.5 × 143	DE3	26	13.6	16.3	19.0
	3,300	E37L451CPN332ME92Q	76.2 × 92	E92	31	11.6	14.0	16.3
	3,900	E37L451CPN392MEA5Q	76.2 × 105	EA5	27	13.2	15.8	18.5
	4,700	E37L451CPN472MEB7Q	76.2 × 117	EB7	22	15.1	18.1	21.1
	5,600	E37L451CPN562MEE3Q	76.2 × 143	EE3	18	17.6	21.2	24.7
	6,800	E37L451CPN682MEJ1Q	76.2 × 181	EJ1	15	21.2	25.5	29.7
	10,000	E37L451CPN103MEM9Q	76.2 × 219	EM9	10	27.8	33.3	38.9
	4,700	E37L451CPN472MF92Q	89 × 92	F92	22	15.2	18.3	21.3
	5,600	E37L451CPN562MFA5Q	89 × 105	FA5	18	17.3	20.8	24.2
	5,600	E37L451CPN562MFB7Q	89 × 117	FB7	18	18.0	21.6	25.2
	8,200	E37L451CPN822MFE3Q	89 × 143	FE3	13	23.3	28.0	32.6
8,200	E37L451CPN822MFF5Q	89 × 155	FF5	13	24.0	28.8	33.6	
12,000	E37L451CPN123MFK0Q	89 × 190	FK0	9	31.3	37.6	43.9	
12,000	E37L451CPN123MFM9Q	89 × 219	FM9	9	33.1	39.8	46.4	
500 Volts 550 Volts Surge	1,500	E37L501HPN152MCB7Q	50.8 × 117	CB7	64	7.1	8.5	10.0
	1,500	E37L501HPN152MCD0Q	50.8 × 130	CD0	64	7.4	8.9	10.3
	1,800	E37L501CPN182MD92Q	63.5 × 92	D92	55	7.9	9.5	11.1
	2,200	E37L501CPN222MDA5Q	63.5 × 105	DA5	45	9.1	11.0	12.8
	2,200	E37L501CPN222MDB7Q	63.5 × 117	DB7	45	9.5	11.4	13.3
	2,700	E37L501CPN272MDD0Q	63.5 × 130	DD0	37	10.9	13.1	15.3
	2,700	E37L501CPN272MDE3Q	63.5 × 143	DE3	37	11.3	13.6	15.8
	2,700	E37L501CPN272ME92Q	76.2 × 92	E92	38	10.5	12.6	14.7
	3,300	E37L501CPN332MEA5Q	76.2 × 105	EA5	31	12.1	14.6	17.0
	3,300	E37L501CPN332MEB7Q	76.2 × 117	EB7	31	12.6	15.2	17.7
	4,700	E37L501CPN472MEE3Q	76.2 × 143	EE3	22	16.2	19.4	22.6
	5,600	E37L501CPN562MEJ1Q	76.2 × 181	EJ1	18	19.3	23.1	27.0
	8,200	E37L501CPN822MEM9Q	76.2 × 219	EM9	13	25.2	30.2	35.2
	3,900	E37L501CPN392MF92Q	89 × 92	F92	27	13.9	16.6	19.4
	3,900	E37L501CPN392MFA5Q	89 × 105	FA5	27	14.5	17.3	20.2
	4,700	E37L501CPN472MFB7Q	89 × 117	FB7	22	16.5	19.8	23.1
	6,800	E37L501CPN682MFE3Q	89 × 143	FE3	15	21.2	25.5	29.7
	6,800	E37L501CPN682MFF5Q	89 × 155	FF5	15	21.9	26.2	30.6
	8,200	E37L501CPN822MFK0Q	89 × 190	FK0	12	26.7	32.0	37.4
10,000	E37L501CPN103MFM9Q	89 × 219	FM9	9	33.1	39.8	46.4	

† For terminal, mounting and construction options, refer to the part numbering system for descriptions and codes.

* Refer to diagram of dimensions for detailed case size specifications.

U37X Series



- Large Can
- Screw Terminals
- High Ripple
- 350 to 500VDC Ratings
- RoHS Compliant
- +85°C Maximum Temperature
- 15,000 Hours Lifetime at +85°C
- Up to 175,000 Hours Useful Life

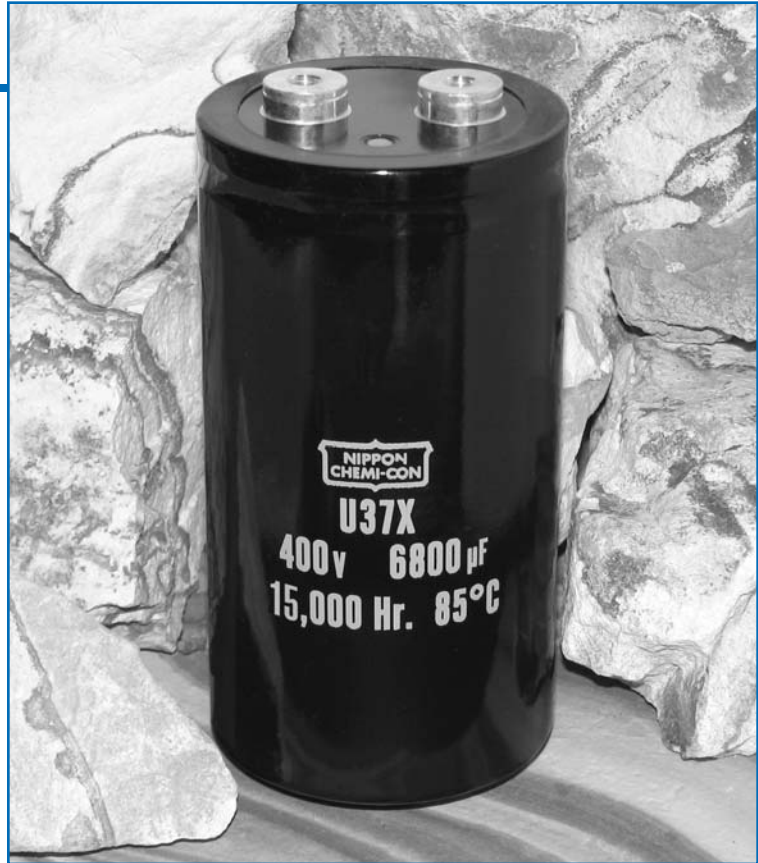

The U37X series is the longest life version of the U37 grade series and is specifically designed to provide the ripple current capability and long life required for high reliability inverter applications. The U37X has an endurance rating of 15,000 hours at +85°C with the rated ripple current applied. The useful life can exceed 175,000 hours at +40°C and 2.1x the ripple current. These capacitors are available in a variety of high current English or Metric thread terminals. Mounting options include a three-footed clamp or bottom threaded stud. Custom designs are also available.

Summary of Specifications

- Screw terminals: high and low post, English and Metric thread.
- Capacitance range: 1,200 to 18,000µF.
- Voltage range: 350 to 500VDC.
- Category temperature range: -40°C to +85°C.
- Leakage current: 0.02CV(µA) or 5mA, whichever is smaller, after 5 minutes at +25°C.
- Standard capacitance tolerance: ±20%
- Nominal case size (D×L): D = 50.8mm (2.000") to 89mm (3.500"); L = 92mm (3.625") to 219mm (8.625").
- Rated lifetime: 15,000 hours at +85°C with rated ripple current applied.

U37X Series

U37X Specifications - Screw Terminals

Item	Characteristics																																															
Category Temperature Range	- 40 to +85°C																																															
Rated Voltage Range	350 to 500VDC																																															
Capacitance Range	1,200 to 18,000 μ F at +25°C, 120Hz																																															
Capacitance Tolerance	\pm 20% (M) at +25°C, 120Hz																																															
Leakage Current	$I = 0.02CV$ (μ A) or 5mA, whichever is smaller, after 5 minutes at +25°C. Where I = Max. leakage current (μ A), C = Nominal capacitance (μ F) and V = Rated voltage (V)																																															
Rated Ripple Current Multipliers	<p>Ambient Temperature (°C)</p> <table border="1"> <thead> <tr> <th>+45°C</th> <th>+65°C</th> <th>+85°C</th> </tr> </thead> <tbody> <tr> <td>2.82</td> <td>1.73</td> <td>1.00</td> </tr> </tbody> </table> <p>Frequency (Hz)</p> <table border="1"> <thead> <tr> <th>DC Rated Voltage</th> <th>50Hz</th> <th>120Hz</th> <th>300Hz</th> <th>1kHz</th> <th>3kHz</th> <th>10kHz</th> </tr> </thead> <tbody> <tr> <td>350-500V</td> <td>0.80</td> <td>1.00</td> <td>1.20</td> <td>1.30</td> <td>1.40</td> <td>1.41</td> </tr> </tbody> </table> <p>To determine maximum ripple current at a specified temperature and frequency, use the appropriate multiplier shown.</p>	+45°C	+65°C	+85°C	2.82	1.73	1.00	DC Rated Voltage	50Hz	120Hz	300Hz	1kHz	3kHz	10kHz	350-500V	0.80	1.00	1.20	1.30	1.40	1.41																											
+45°C	+65°C	+85°C																																														
2.82	1.73	1.00																																														
DC Rated Voltage	50Hz	120Hz	300Hz	1kHz	3kHz	10kHz																																										
350-500V	0.80	1.00	1.20	1.30	1.40	1.41																																										
Endurance (Load Life)	<p>The following specifications shall be satisfied when the capacitors are restored to +25°C after subjecting them to DC voltage for 15,000 hours at +85°C with the rated ripple current applied. The sum of the DC voltage and peak AC voltage must not exceed the full rated voltage of the capacitors.</p> <p>Capacitance change: \leq 20% from initial measurement ESR change : \leq 200% of initial specified limit Leakage current : \leq initial specified limit</p>																																															
Useful Life	<p>With specified standard voltage and ripple current applied, typical life as function of ambient temperature is listed below.</p> <table border="1"> <thead> <tr> <th>Temperature</th> <th>Life (hours max.)</th> </tr> </thead> <tbody> <tr> <td>+85°C</td> <td>20,000</td> </tr> <tr> <td>+65°C</td> <td>71,600</td> </tr> <tr> <td>+45°C</td> <td>175,000</td> </tr> </tbody> </table> <p>Capacitance change: \leq 30% from initial measurement ESR change : \leq 300% of initial specified limit Leakage current : \leq initial specified limit</p>	Temperature	Life (hours max.)	+85°C	20,000	+65°C	71,600	+45°C	175,000																																							
Temperature	Life (hours max.)																																															
+85°C	20,000																																															
+65°C	71,600																																															
+45°C	175,000																																															
Shelf Life	<p>The following specifications shall be satisfied when the capacitors are restored to +25°C after exposing them for 500 hours at +85°C without voltage applied. The rated voltage shall be applied to the capacitors for a minimum of 30 minutes, at least 24 hours and not more than 48 hours before the measurements.</p> <p>Capacitance change: \leq 20% from initial measurement ESR change : \leq 200% of initial specified limit Leakage current : \leq initial specified limit</p>																																															
Vibration Rating	10-55Hz, 10g sinusoidal in three axes, 2 hours per axis.																																															
Maximum Tightening Torque	<table border="1"> <thead> <tr> <th>Terminal Code</th> <th>HP</th> <th>HL</th> <th>CD</th> <th>CP</th> <th>CH</th> <th>CA</th> <th>CS</th> </tr> </thead> <tbody> <tr> <td>Thread Size</td> <td>10-32 NF-2B</td> <td>M5x0.8-6H</td> <td></td> <td>1/4-28 NF-2B</td> <td></td> <td>M6x1-6H</td> <td></td> </tr> <tr> <td>3 Threads Engaged</td> <td colspan="3">2.0 N·m (18.0 in·lb)</td> <td colspan="4">4.0 N·m (35.0 in·lb)</td> </tr> <tr> <td>6 Threads Engaged</td> <td colspan="3">2.8 N·m (25.0 in·lb)</td> <td colspan="4">6.2 N·m (55.0 in·lb)</td> </tr> </tbody> </table>	Terminal Code	HP	HL	CD	CP	CH	CA	CS	Thread Size	10-32 NF-2B	M5x0.8-6H		1/4-28 NF-2B		M6x1-6H		3 Threads Engaged	2.0 N·m (18.0 in·lb)			4.0 N·m (35.0 in·lb)				6 Threads Engaged	2.8 N·m (25.0 in·lb)			6.2 N·m (55.0 in·lb)																		
Terminal Code	HP	HL	CD	CP	CH	CA	CS																																									
Thread Size	10-32 NF-2B	M5x0.8-6H		1/4-28 NF-2B		M6x1-6H																																										
3 Threads Engaged	2.0 N·m (18.0 in·lb)			4.0 N·m (35.0 in·lb)																																												
6 Threads Engaged	2.8 N·m (25.0 in·lb)			6.2 N·m (55.0 in·lb)																																												
Typical Inductance (nH) at 1MHz	<table border="1"> <thead> <tr> <th rowspan="2">Case Diameter (mm)</th> <th colspan="7">Terminal Code</th> </tr> <tr> <th>HP</th> <th>HL</th> <th>CD</th> <th>CP</th> <th>CH</th> <th>CA</th> <th>CS</th> </tr> </thead> <tbody> <tr> <td>ϕ50.8</td> <td>—</td> <td>—</td> <td>NA</td> <td>NA</td> <td>NA</td> <td>NA</td> <td>NA</td> </tr> <tr> <td>ϕ63.5</td> <td>—</td> <td>—</td> <td>—</td> <td>—</td> <td>—</td> <td>—</td> <td>—</td> </tr> <tr> <td>ϕ76.2</td> <td>30</td> <td>30</td> <td>25</td> <td>20</td> <td>25</td> <td>20</td> <td>25</td> </tr> <tr> <td>ϕ89.0</td> <td>30</td> <td>30</td> <td>25</td> <td>20</td> <td>25</td> <td>20</td> <td>25</td> </tr> </tbody> </table>	Case Diameter (mm)	Terminal Code							HP	HL	CD	CP	CH	CA	CS	ϕ 50.8	—	—	NA	NA	NA	NA	NA	ϕ 63.5	—	—	—	—	—	—	—	ϕ 76.2	30	30	25	20	25	20	25	ϕ 89.0	30	30	25	20	25	20	25
Case Diameter (mm)	Terminal Code																																															
	HP	HL	CD	CP	CH	CA	CS																																									
ϕ 50.8	—	—	NA	NA	NA	NA	NA																																									
ϕ 63.5	—	—	—	—	—	—	—																																									
ϕ 76.2	30	30	25	20	25	20	25																																									
ϕ 89.0	30	30	25	20	25	20	25																																									
Custom Designs	Custom CV values per case size and termination type may be available upon request. Contact appropriate representative with specific requirements.																																															

U37X Series

U37X Useful Life

Useful Life: 20,000 Hours at +85°C

The life expectancy of a capacitor is shown as a function of ambient temperature and ripple current load.

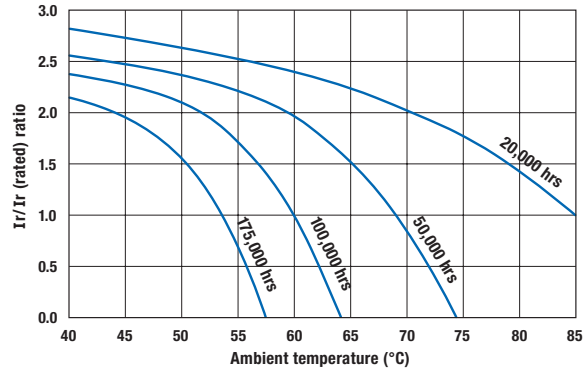
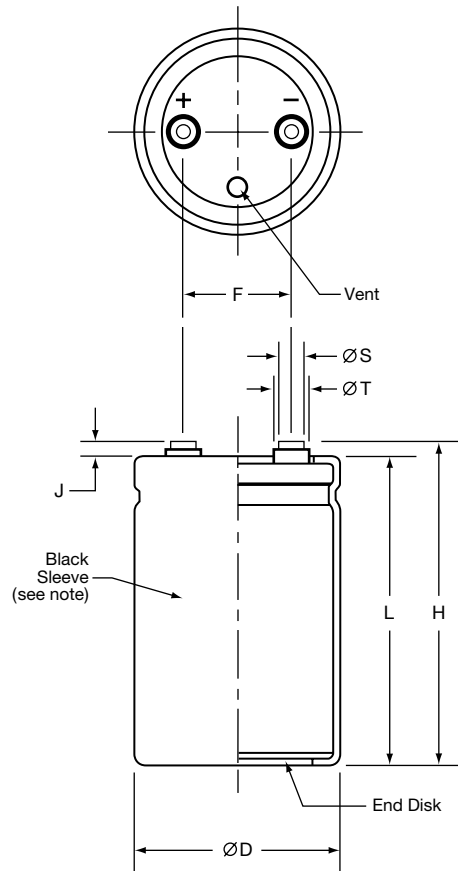

Diagram of Dimensions - Screw Terminals

Large Can/Screw Terminals

Unit: mm (inches)



Case Dimensions and Standard Box Quantities

Case Size Code	ØD +2.0 (0.080)	L ±1.0 (0.040)	F ±0.25 (0.010)	Standard Box Quantity
CB7 CD0	50.8 (2.000)	117 (4.625) 130 (5.125)	22.2 (0.875)	49
D92 DA5 DB7 DD0 DE3	63.5 (2.500)	92 (3.625) 105 (4.125) 117 (4.625) 130 (5.125) 143 (5.625)	28.6 (1.125)	20
E92 EA5 EB7 EE3 EJ1 EM9	76.2 (3.000)	92 (3.625) 105 (4.125) 117 (4.625) 143 (5.625) 181 (7.125) 219 (8.625)	31.8 (1.250)	16 9
F92 FA5 FB7 FE3 FF5 FK0 FM9	89.0 (3.500)	92 (3.625) 105 (4.125) 117 (4.625) 143 (5.625) 155 (6.125) 190 (7.500) 219 (8.625)	31.8 (1.250)	5

Note:

In some cases, the color of the sleeve may change slightly due to the operating conditions, however, the discoloration will not impair capacitor function.

Terminal Specifications

Terminal Code	Available Case Diameter		Thread Size	Minimum Thread Depth	J ±0.5 (0.020)	H ±2.0 (0.080)	ØS ±0.25 (0.010)	ØT ±0.25 (0.010)
	ØD Code	ØD mm (inches)						
HP	C	50.8 (2.000)	10-32 NF-2B	9.5 (0.375)	6.4 (0.250)	L+J	8.0 (0.313)	11.1 (0.438)
HL	C	50.8 (2.000)	M5x0.8-6H	9.5 (0.375)	6.4 (0.250)	L+J	8.0 (0.313)	11.1 (0.438)
CD	D-E	63.5 - 76.2 (2.500 - 3.000)	M5x0.8-6H	8.5 (0.335)	5.0 (0.200)	L+J	13.0 (0.512)	18.8 (0.740)
CP	D-F	63.5 - 89.0 (2.500 - 3.500)	1/4-28 NF-2B	8.7 (0.344)	2.4 (0.093)	L+J	17.5 (0.689)	—
CH	D-F	63.5 - 89.0 (2.500 - 3.500)	1/4-28 NF-2B	11.9 (0.468)	6.4 (0.250)	L+J	17.5 (0.689)	—
CA	D-F	63.5 - 89.0 (2.500 - 3.500)	M6x1-6H	8.7 (0.344)	2.4 (0.093)	L+J	17.5 (0.689)	—
CS	D-F	63.5 - 89.0 (2.500 - 3.500)	M6x1-6H	11.9 (0.468)	6.4 (0.250)	L+J	17.5 (0.689)	—

Mounting Hardware is optional. Refer to hardware specifications on the following page.

U37X Series

Mounting Hardware - Screw Terminals

Type C: Three-Footed Clamp

Unit: mm (inches)

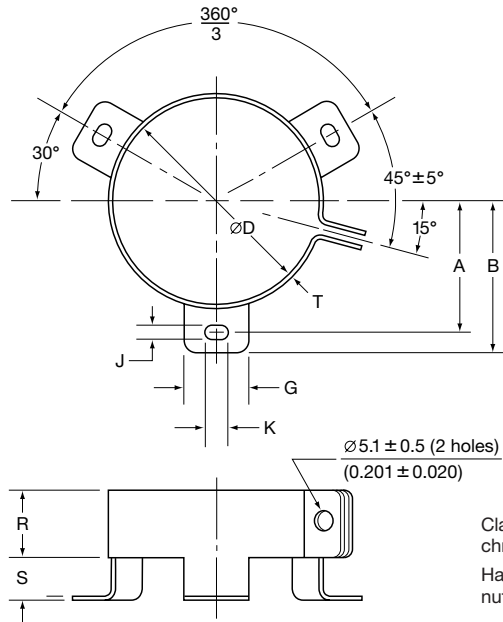

Clamp: Zinc with silver trivalent chromate post treatment.
Hardware: Screw, washer and hexagon nut included with each clamp.

Type C: Clamp Dimensions

Mounting Code	Case ØD	A ±1.0 (0.040)	B ±1.0 (0.040)	G ±1.0 (0.040)	J ±0.5 (0.020)	K ±0.5 (0.020)	R ±1.0 (0.040)	S ±1.0 (0.040)	T ±0.5 (0.020)
C	50.8 (2.000)	31.8 (1.250)	36.5 (1.437)	13.3 (0.524)	4.5 (0.177)	7.1 (0.280)	19.1 (0.751)	9.5 (0.374)	0.8 (0.032)
C	63.5 (2.500)	38.1 (1.500)	42.9 (1.689)	13.3 (0.524)	4.5 (0.177)	7.1 (0.280)	19.1 (0.751)	9.5 (0.374)	0.8 (0.032)
C	76.2 (3.000)	44.5 (1.750)	49.2 (1.937)	13.3 (0.524)	4.5 (0.177)	7.1 (0.280)	19.1 (0.751)	9.5 (0.374)	1.0 (0.040)
C	89.0 (3.500)	50.8 (2.000)	56.5 (2.224)	16.0 (0.630)	4.5 (0.177)	8.0 (0.313)	21.0 (0.827)	9.0 (0.354)	1.0 (0.040)

Type S: Stud Mounting

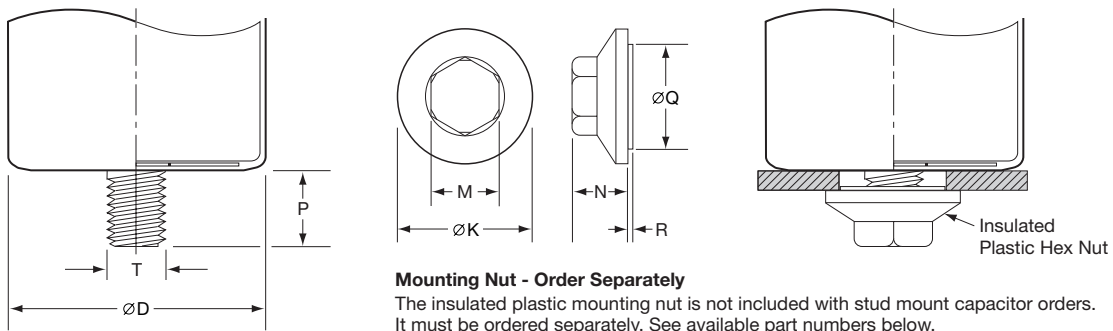

Mounting Nut - Order Separately

The insulated plastic mounting nut is not included with stud mount capacitor orders. It must be ordered separately. See available part numbers below.

Type S: Stud Dimensions

Mounting Code	P ±1.0 (0.040)	T Thread Size
S	16.0 (0.630)	M12

Mounting Nut Dimensions

Part Number	ØK ±2.0 (0.080)	M ±1.0 (0.040)	N ±1.0 (0.040)	ØQ ±1.0 (0.040)	R ±1.0 (0.040)
50-8D	30.0 (1.181)	19.0 (0.748)	18.0 (0.709)	22.0 (0.866)	1.40 (0.055)
50-8E	38.0 (1.496)	19.0 (0.748)	18.0 (0.709)	30.0 (1.181)	1.40 (0.055)

U37X Series

Part Numbering System for U37X Series When ordering, always specify complete 18-field global part number.

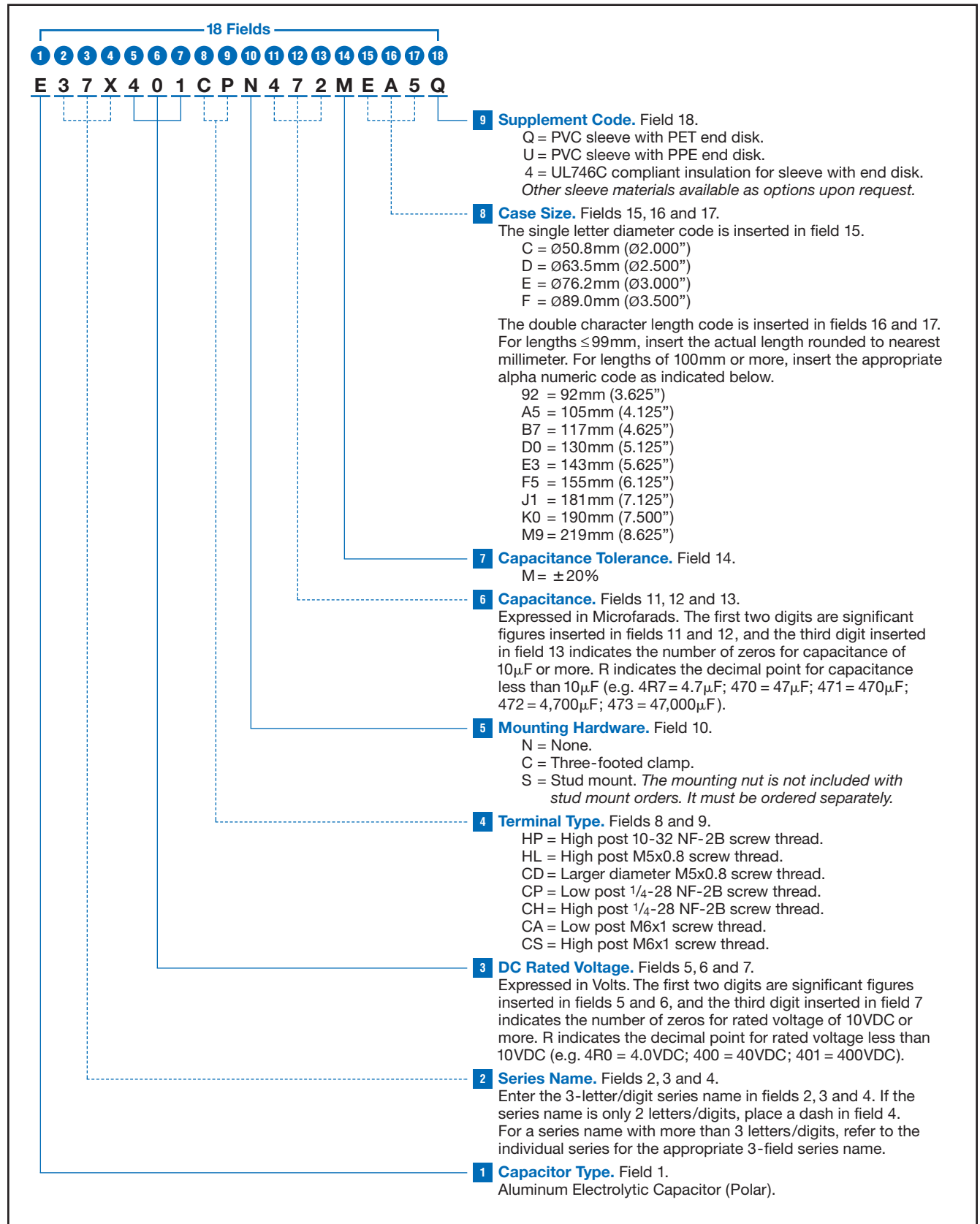

U37X Series

Standard Voltage Ratings - Screw Terminals

Rated Voltage (WVDC)	Capacitance (µF)	Global Part Number†	Nominal Case Size* D × L (mm)	Case Size Code	Maximum ESR (mΩ) at +25°C, 120Hz	Rated Ripple Current (A rms) at +85°C		
						120Hz	300Hz	>3kHz
350 Volts 400 Volts Surge	2,700	E37X351HPN272MCB7Q	50.8 × 117	CB7	35	9.6	11.5	13.4
	3,300	E37X351HPN332MCD0Q	50.8 × 130	CD0	31	10.6	12.8	14.9
	2,700	E37X351CPN272MD92Q	63.5 × 92	D92	37	9.7	11.6	13.5
	3,300	E37X351CPN332MDA5Q	63.5 × 105	DA5	31	11.1	13.3	15.5
	3,900	E37X351CPN392MDB7Q	63.5 × 117	DB7	26	12.4	14.9	17.4
	4,700	E37X351CPN472MDD0Q	63.5 × 130	DD0	23	13.8	16.5	19.3
	4,700	E37X351CPN472MDE3Q	63.5 × 143	DE3	21	15.1	18.1	21.2
	3,900	E37X351CPN392ME92Q	76.2 × 92	E92	26	12.7	15.2	17.8
	4,700	E37X351CPN472MEA5Q	76.2 × 105	EA5	22	14.5	17.4	20.3
	5,600	E37X351CPN562MEB7Q	76.2 × 117	EB7	19	16.3	19.5	22.8
	8,200	E37X351CPN822MEE3Q	76.2 × 143	EE3	15	19.8	23.7	27.7
	10,000	E37X351CPN103MEJ1Q	76.2 × 181	EJ1	11	25.0	30.0	35.0
	12,000	E37X351CPN123MEM9Q	76.2 × 219	EM9	9	30.1	36.1	42.2
	5,600	E37X351CPN562MF92Q	89 × 92	F92	19	16.2	19.4	22.7
	6,800	E37X351CPN682MFA5Q	89 × 105	FA5	16	18.5	22.2	25.9
	8,200	E37X351CPN822MFB7Q	89 × 117	FB7	14	20.7	24.9	29.0
	12,000	E37X351CPN123MFE3Q	89 × 143	FE3	11	25.2	30.2	35.2
	12,000	E37X351CPN123MFF5Q	89 × 155	FF5	10	27.3	32.8	38.2
	15,000	E37X351CPN153MFK0Q	89 × 190	FK0	8	33.3	40.0	46.6
18,000	E37X351CPN183MFM9Q	89 × 219	FM9	6	38.2	45.8	53.5	
400 Volts 450 Volts Surge	2,700	E37X401HPN272MCB7Q	50.8 × 117	CB7	41	8.9	10.7	12.5
	2,700	E37X401HPN272MCD0Q	50.8 × 130	CD0	35	9.9	11.9	13.9
	2,700	E37X401CPN272MD92Q	63.5 × 92	D92	43	9.0	10.8	12.6
	2,700	E37X401CPN272MDA5Q	63.5 × 105	DA5	36	10.3	12.3	14.4
	3,300	E37X401CPN332MDB7Q	63.5 × 117	DB7	31	11.6	13.9	16.2
	3,900	E37X401CPN392MDD0Q	63.5 × 130	DD0	27	12.8	15.4	18.0
	3,900	E37X401CPN392MDE3Q	63.5 × 143	DE3	24	14.1	16.9	19.7
	3,900	E37X401CPN392ME92Q	76.2 × 92	E92	30	11.8	14.2	16.5
	4,700	E37X401CPN472MEA5Q	76.2 × 105	EA5	25	13.5	16.2	18.9
	5,600	E37X401CPN562MEB7Q	76.2 × 117	EB7	22	15.2	18.2	21.2
	6,800	E37X401CPN682MEE3Q	76.2 × 143	EE3	17	18.4	22.1	25.8
	8,200	E37X401CPN822MEJ1Q	76.2 × 181	EJ1	13	23.3	27.9	32.6
	12,000	E37X401CPN123MEM9Q	76.2 × 219	EM9	10	28.0	33.6	39.3
	5,600	E37X401CPN562MF92Q	89 × 92	F92	22	15.1	18.1	21.1
	6,800	E37X401CPN682MFA5Q	89 × 105	FA5	19	17.2	20.6	24.1
	6,800	E37X401CPN682MFB7Q	89 × 117	FB7	16	19.3	23.2	27.0
	10,000	E37X401CPN103MFE3Q	89 × 143	FE3	12	23.4	28.1	32.8
	10,000	E37X401CPN103MFF5Q	89 × 155	FF5	11	25.4	30.5	35.6
	12,000	E37X401CPN123MFK0Q	89 × 190	FK0	9	31.0	37.2	43.4
15,000	E37X401CPN153MFM9Q	89 × 219	FM9	7	35.6	42.7	49.8	
420 Volts 470 Volts Surge	2,200	E37X421HPN222MCB7Q	50.8 × 117	CB7	44	8.5	10.2	11.9
	2,700	E37X421HPN272MCD0Q	50.8 × 130	CD0	39	9.4	11.3	13.2
	2,200	E37X421CPN222MD92Q	63.5 × 92	D92	47	8.6	10.3	12.0
	2,700	E37X421CPN272MDA5Q	63.5 × 105	DA5	39	9.8	11.8	13.8
	3,300	E37X421CPN332MDB7Q	63.5 × 117	DB7	33	11.0	13.3	15.5
	3,900	E37X421CPN392MDD0Q	63.5 × 130	DD0	29	12.2	14.7	17.1
	3,900	E37X421CPN392MDE3Q	63.5 × 143	DE3	26	13.4	16.1	18.8
	3,300	E37X421CPN332ME92Q	76.2 × 92	E92	33	11.3	13.5	15.8
	3,900	E37X421CPN392MEA5Q	76.2 × 105	EA5	28	12.9	15.5	18.0
	4,700	E37X421CPN472MEB7Q	76.2 × 117	EB7	24	14.5	17.4	20.3
	5,600	E37X421CPN562MEE3Q	76.2 × 143	EE3	19	17.6	21.1	24.6
	8,200	E37X421CPN822MEJ1Q	76.2 × 181	EJ1	14	22.2	26.6	31.1
	10,000	E37X421CPN103MEM9Q	76.2 × 219	EM9	11	26.8	32.1	37.5
	4,700	E37X421CPN472MF92Q	89 × 92	F92	25	14.4	17.3	20.2
	5,600	E37X421CPN562MFA5Q	89 × 105	FA5	21	16.4	19.7	23.0

† For terminal, mounting and construction options, refer to the part numbering system for descriptions and codes.

* Refer to diagram of dimensions for detailed case size specifications.

U37X Series

Standard Voltage Ratings - Screw Terminals

Rated Voltage (WVDC)	Capacitance (µF)	Global Part Number†	Nominal Case Size* D × L (mm)	Case Size Code	Maximum ESR (mΩ) at +25°C, 120Hz	Rated Ripple Current (A rms) at +85°C		
						120Hz	300Hz	>3kHz
420 Volts 470 Volts Surge	6,800	E37X421CPN682MFB7Q	89 × 117	FB7	18	18.4	22.1	25.8
	8,200	E37X421CPN822MFE3Q	89 × 143	FE3	14	22.4	26.8	31.3
	10,000	E37X421CPN103MFF5Q	89 × 155	FF5	12	24.3	29.1	34.0
	12,000	E37X421CPN123MFK0Q	89 × 190	FK0	10	29.6	35.5	41.4
	15,000	E37X421CPN153MFM9Q	89 × 219	FM9	8	34.0	40.7	47.5
450 Volts 500 Volts Surge	1,800	E37X451HPN182MCB7Q	50.8 × 117	CB7	51	8.0	9.6	11.2
	2,200	E37X451HPN222MCD0Q	50.8 × 130	CD0	44	8.9	10.6	12.4
	2,200	E37X451CPN222MD92Q	63.5 × 92	D92	53	8.1	9.7	11.3
	2,200	E37X451CPN222MDA5Q	63.5 × 105	DA5	44	9.2	11.1	12.9
	2,700	E37X451CPN272MDB7Q	63.5 × 117	DB7	38	10.4	12.4	14.5
	3,300	E37X451CPN332MDD0Q	63.5 × 130	DD0	33	11.5	13.8	16.1
	3,900	E37X451CPN392MDE3Q	63.5 × 143	DE3	30	12.6	15.1	17.6
	3,300	E37X451CPN332ME92Q	76.2 × 92	E92	38	10.6	12.7	14.8
	3,900	E37X451CPN392MEA5Q	76.2 × 105	EA5	32	12.1	14.5	16.9
	3,900	E37X451CPN392MEB7Q	76.2 × 117	EB7	27	13.6	16.3	19.0
	5,600	E37X451CPN562MEE3Q	76.2 × 143	EE3	21	16.5	19.8	23.1
	6,800	E37X451CPN682MEJ1Q	76.2 × 181	EJ1	16	20.8	25.0	29.2
	8,200	E37X451CPN822MEM9Q	76.2 × 219	EM9	13	25.1	30.1	35.2
	3,900	E37X451CPN392MF92Q	89 × 92	F92	28	13.5	16.2	18.9
	4,700	E37X451CPN472MFA5Q	89 × 105	FA5	23	15.4	18.5	21.6
	5,600	E37X451CPN562MFB7Q	89 × 117	FB7	20	17.3	20.7	24.2
	8,200	E37X451CPN822MFE3Q	89 × 143	FE3	16	21.0	25.2	29.4
	8,200	E37X451CPN822MFF5Q	89 × 155	FF5	14	22.8	27.3	31.9
	10,000	E37X451CPN103MFK0Q	89 × 190	FK0	11	27.8	33.3	38.9
	12,000	E37X451CPN123MFM9Q	89 × 219	FM9	9	32.2	38.6	45.0
500 Volts 550 Volts Surge	1,200	E37X501HPN122MCB7Q	50.8 × 117	CB7	78	6.4	7.7	9.0
	1,500	E37X501HPN152MCD0Q	50.8 × 130	CD0	68	7.2	8.6	10.0
	1,500	E37X501CPN152MD92Q	63.5 × 92	D92	67	7.2	8.6	10.1
	1,800	E37X501CPN182MDA5Q	63.5 × 105	DA5	56	8.2	9.9	11.5
	2,200	E37X501CPN222MDB7Q	63.5 × 117	DB7	48	9.3	11.1	13.0
	2,700	E37X501CPN272MDD0Q	63.5 × 130	DD0	42	10.3	12.3	14.4
	2,700	E37X501CPN272MDE3Q	63.5 × 143	DE3	37	11.3	13.5	15.8
	2,200	E37X501CPN222ME92Q	76.2 × 92	E92	48	9.5	11.3	13.2
	2,700	E37X501CPN272MEA5Q	76.2 × 105	EA5	40	10.8	13.0	15.1
	3,300	E37X501CPN332MEB7Q	76.2 × 117	EB7	34	12.1	14.6	17.0
	3,900	E37X501CPN392MEE3Q	76.2 × 143	EE3	26	14.8	17.7	20.7
	5,600	E37X501CPN562MEJ1Q	76.2 × 181	EJ1	20	18.6	22.3	26.1
	6,800	E37X501CPN682MEM9Q	76.2 × 219	EM9	16	22.5	26.9	31.4
	3,300	E37X501CPN332MF92Q	89 × 92	F92	35	12.1	14.5	16.9
	3,900	E37X501CPN392MFA5Q	89 × 105	FA5	29	13.8	16.5	19.3
	4,700	E37X501CPN472MFB7Q	89 × 117	FB7	25	15.5	18.5	21.6
	5,600	E37X501CPN562MFE3Q	89 × 143	FE3	19	18.8	22.5	26.3
	6,800	E37X501CPN682MFF5Q	89 × 155	FF5	18	20.4	24.4	28.5
	8,200	E37X501CPN822MFK0Q	89 × 190	FK0	14	24.8	29.8	34.8
	10,000	E37X501CPN103MFM9Q	89 × 219	FM9	12	28.5	34.2	39.9

†For terminal, mounting and construction options, refer to the part numbering system for descriptions and codes.

*Refer to diagram of dimensions for detailed case size specifications.

UTOR Series



- Toroidal Design
- Lowest Thermal Resistance
- Optimum Cooling Capability
- Higher Ripple
- Low Profile Sizes
- Heat Sink Mounting Kit
- RoHS Compliant
- 5,000 Hours Lifetime at +105°C

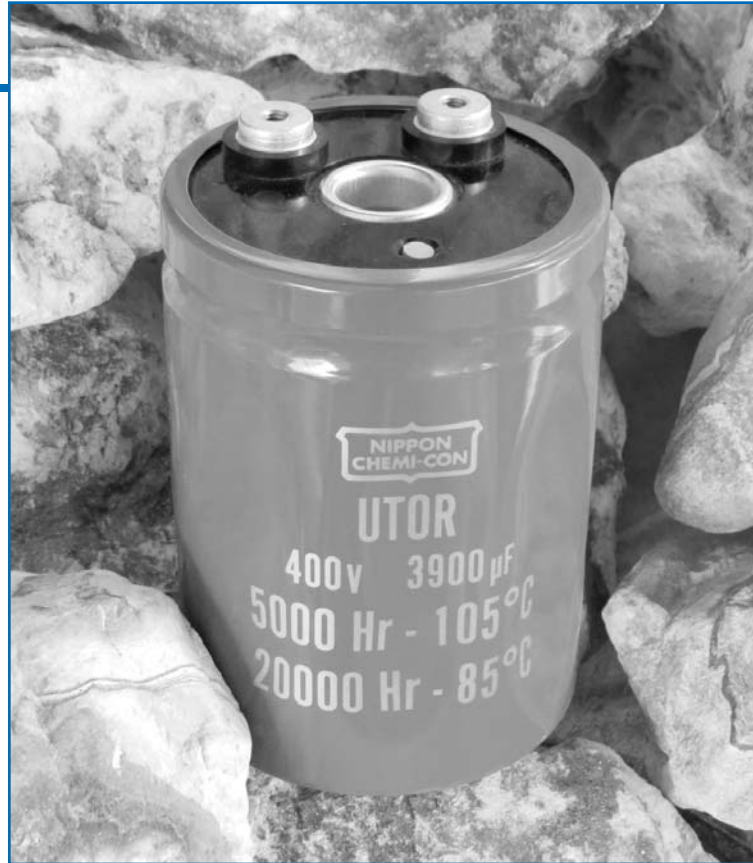

The UTOR series available in low profile sizes offers high capacitance and ripple current per case size which allows the inverter designer to significantly reduce the size, weight, and cost of the capacitor bank. The toroidal geometry is ideal for cooling by either forced air or by heat sink with the use of a new mounting kit option. The heat sink kit option provides optimum thermal transfer while maintaining electrical isolation. These capacitors have an endurance rating of 5,000 hours at +105°C or 20,000 hours at +85°C with the rated ripple current applied. The UTOR series represents the optimum cost per amp of ripple current for a screw terminal mounted electrolytic capacitor.

Summary of Specifications

- Screw terminals, high ripple Metric thread.
- Capacitance range: 680 to 10,000µF.
- Voltage range: 350 to 500VDC.
- Operating temperature range: -40°C to +105°C.
- Leakage current: 0.02CV(µA) or 5mA, whichever is smaller, after 5 minutes at +25°C.
- Standard capacitance tolerance: ±20%
- Nominal case size (D × L): D = 76.2mm (3.000"); L = 54mm (2.125") to 168mm (6.625").
- Rated lifetime: 5,000 hours at +105°C with rated ripple current applied.

UTOR Series

UTOR Specifications - Screw Terminals

Item	Characteristics																											
Category Temperature Range	- 40 to +105°C																											
Rated Voltage Range	350 to 500VDC																											
Capacitance Range	680 to 10,000µF at +25°C, 120Hz																											
Capacitance Tolerance	± 20% (M) at +25°C, 120Hz																											
Leakage Current	I = 0.02CV (µA) or 5mA, whichever is smaller, after 5 minutes at +25°C. Where I = Max. leakage current (µA), C = Nominal capacitance (µF) and V = Rated voltage (V)																											
Rated Ripple Current Multipliers	<p>Ambient Temperature (°C)</p> <table border="1" style="margin-left: 20px;"> <tr> <td>+45°C</td> <td>+65°C</td> <td>+85°C</td> <td>+105°C</td> </tr> <tr> <td>2.45</td> <td>2.12</td> <td>1.73</td> <td>1.00</td> </tr> </table> <p>Cooling</p> <table border="1" style="margin-left: 20px;"> <thead> <tr> <th rowspan="2">Mounting Type</th> <th colspan="3">Air Velocity</th> </tr> <tr> <th>Static</th> <th>1.0m/s</th> <th>2.0m/s</th> </tr> </thead> <tbody> <tr> <td>Clamp Mount</td> <td>1.00</td> <td>1.20</td> <td>1.30</td> </tr> <tr> <td>Heat Sink (air cooled)</td> <td>1.20</td> <td>1.45</td> <td>1.55</td> </tr> <tr> <td>Heat Sink (fluid cooled)</td> <td>1.35</td> <td>1.65</td> <td>1.75</td> </tr> </tbody> </table>	+45°C	+65°C	+85°C	+105°C	2.45	2.12	1.73	1.00	Mounting Type	Air Velocity			Static	1.0m/s	2.0m/s	Clamp Mount	1.00	1.20	1.30	Heat Sink (air cooled)	1.20	1.45	1.55	Heat Sink (fluid cooled)	1.35	1.65	1.75
+45°C	+65°C	+85°C	+105°C																									
2.45	2.12	1.73	1.00																									
Mounting Type	Air Velocity																											
	Static	1.0m/s	2.0m/s																									
Clamp Mount	1.00	1.20	1.30																									
Heat Sink (air cooled)	1.20	1.45	1.55																									
Heat Sink (fluid cooled)	1.35	1.65	1.75																									
Endurance (Load Life)	<p>The following specifications shall be satisfied when the capacitors are restored to +25°C after subjecting them to DC voltage for 5,000 hours at +105°C with the rated ripple current applied. The sum of the DC voltage and peak AC voltage must not exceed the full rated voltage of the capacitors.</p> <p>Capacitance change: ≤ ± 20% of initial measured value ESR change : ≤ 200% of initial specified value Leakage current : ≤ initial specified value</p>																											
Shelf Test	<p>The following specifications shall be satisfied when the capacitors are restored to +25°C after exposing them for 1,000 hours at +105°C without voltage applied. The rated voltage shall be applied to the capacitors for a minimum of 30 minutes, at least 24 hours and not more than 48 hours before the measurements.</p> <p>Capacitance change: ≤ ± 20% of initial measured value ESR change : ≤ 200% of initial specified value Leakage current : ≤ initial specified value</p>																											
Vibration Rating	10-55Hz, 10g sinusoidal in three axis, 2 hours per axis.																											
Maximum Tightening Torque	<table border="1" style="margin-left: 20px;"> <thead> <tr> <th rowspan="2">Terminal Code</th> <th rowspan="2">Thread Size</th> <th colspan="2">3 Threads Engaged</th> <th colspan="2">6 Threads Engaged</th> </tr> <tr> <th>in·lb</th> <th>N·m</th> <th>in·lb</th> <th>N·m</th> </tr> </thead> <tbody> <tr> <td>CT</td> <td>M5x0.8</td> <td>18.0</td> <td>2.0</td> <td>28.5</td> <td>3.2</td> </tr> </tbody> </table>	Terminal Code	Thread Size	3 Threads Engaged		6 Threads Engaged		in·lb	N·m	in·lb	N·m	CT	M5x0.8	18.0	2.0	28.5	3.2											
Terminal Code	Thread Size			3 Threads Engaged		6 Threads Engaged																						
		in·lb	N·m	in·lb	N·m																							
CT	M5x0.8	18.0	2.0	28.5	3.2																							
Typical Inductance	25nH at 1MHz																											
Custom Designs	Custom CV values per case size may be available upon request. Contact appropriate representative with specific requirements.																											

UTOR Series

Diagram of Dimensions - Screw Terminals

Toroidal Large Can/Screw Terminals

Unit: mm and inches

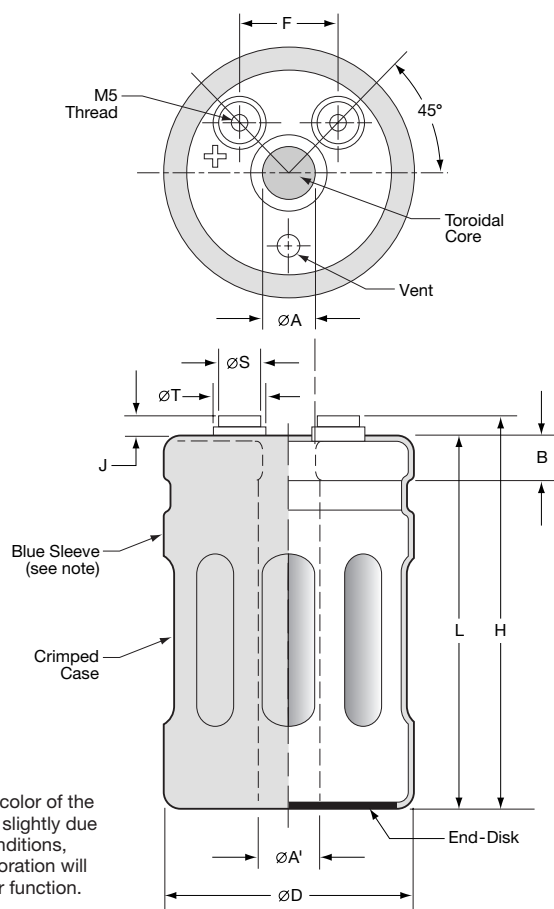

Note:
In some cases, the color of the sleeve may change slightly due to the operating conditions, however, the discoloration will not impair capacitor function.

Terminal Specifications in Millimeters

Terminal Code	Thread Size	Minimum Thread Depth	J ± 0.50	ϕS ± 0.25	ϕT ± 0.25
CT	M5x0.8	10.5	7.0	13.0	18.5

Terminal Specifications in Inches

Terminal Code	Thread Size	Minimum Thread Depth	J ± 0.020	ϕS ± 0.010	ϕT ± 0.010
CT	M5x0.8	0.413	0.276	0.512	0.728

Case Dimensions in Millimeters

ϕA ± 0.20	$\phi A'$ ± 0.30	B ± 0.5	F ± 0.25
16.3	18.9	9.5	31.8

Case Dimensions in Inches

ϕA ± 0.008	$\phi A'$ ± 0.012	B ± 0.020	F ± 0.010
0.642	0.744	0.374	1.250

Case Size Code	ϕD +2.0	L +2.0	H ± 1.0
E54	76.2	54	61
E67	76.2	67	74
E79	76.2	79	86
E92	76.2	92	99
EA5	76.2	105	112
EB7	76.2	117	124
ED0	76.2	130	137
EE3	76.2	143	150
EF5	76.2	155	162
EG8	76.2	168	175

Case Size Code	ϕD +0.080	L +0.080	H ± 0.040
E54	3.000	2.125	2.402
E67	3.000	2.625	2.913
E79	3.000	3.125	3.386
E92	3.000	3.625	3.898
EA5	3.000	4.125	4.409
EB7	3.000	4.625	4.882
ED0	3.000	5.125	5.394
EE3	3.000	5.625	5.906
EF5	3.000	6.125	6.378
EG8	3.000	6.625	6.890

UTOR Series

Mounting Hardware - Screw Terminals

Type C: Three-Footed Clamp

Unit: mm (inches)

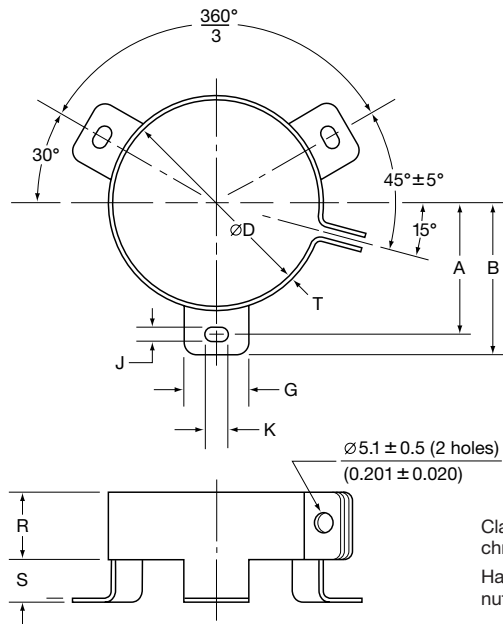

Clamp: Zinc with silver trivalent chromate post treatment.

Hardware: Screw, washer and hexagon nut included with each clamp.

Type C: Clamp Specifications

Mounting Code	Case $\varnothing D$	A	B	G	J	K	R	S	T
		± 1.0 (0.040)	± 1.0 (0.040)	± 1.0 (0.040)	± 0.5 (0.020)	± 0.5 (0.020)	± 1.0 (0.040)	± 1.0 (0.040)	± 0.5 (0.020)
C	76.2 (3.000)	44.5 (1.750)	49.2 (1.937)	13.3 (0.524)	4.5 (0.177)	7.1 (0.280)	19.1 (0.751)	9.5 (0.374)	1.0 (0.040)

UTOR Series

Mounting Hardware - Screw Terminals

Type H: Heat Sink Mounting Kit

Unit: mm (inches)

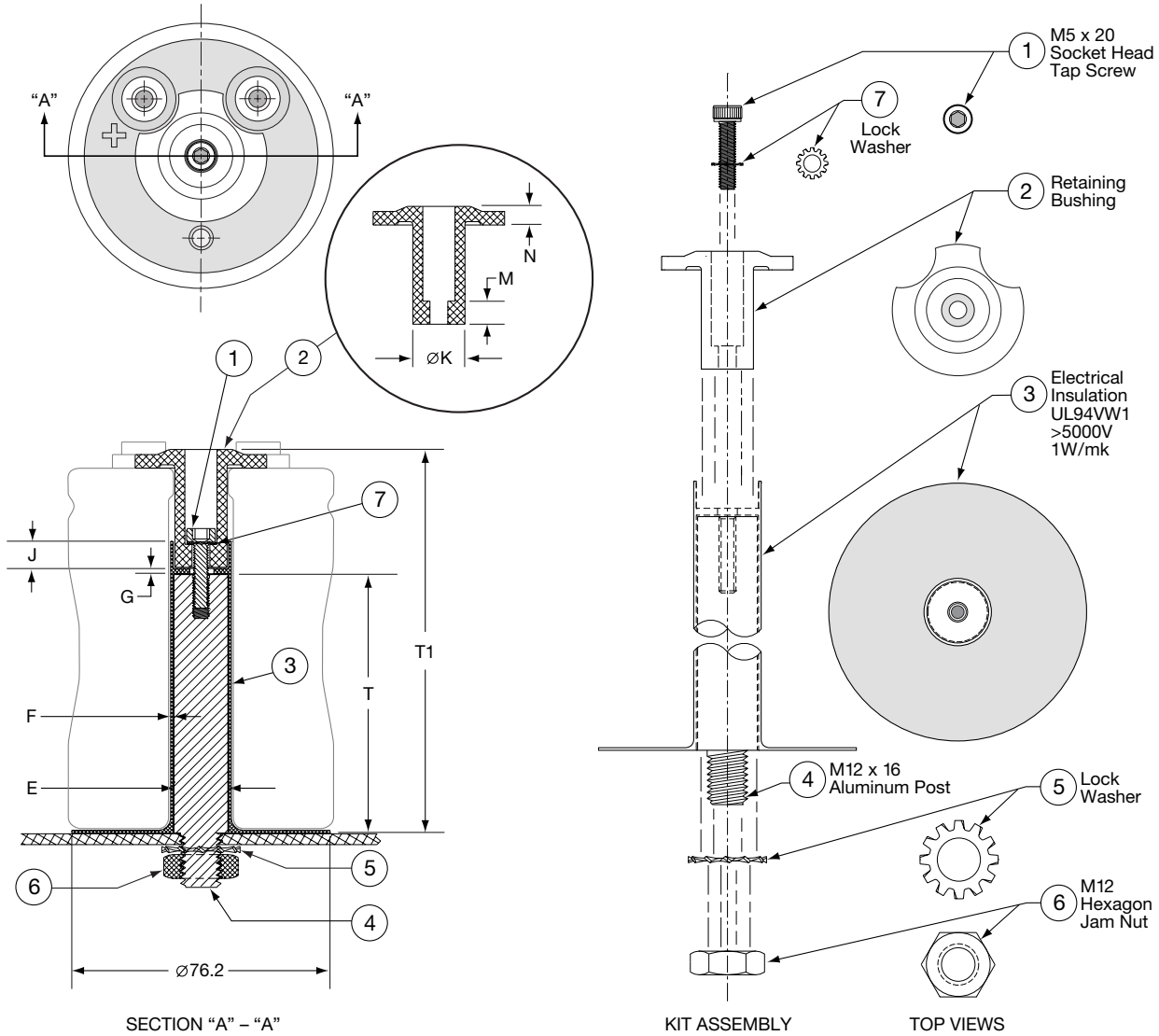

Type H: Heat Sink Mounting Kit Dimensions

Mounting Code	Case Size Code	T ± 0.2 (0.008)	T1 ± 0.5 (0.020)
H	E54	35 (1.378)	58 (2.280)
H	E67	35 (1.378)	71 (2.780)
H	E79	60 (2.362)	83 (3.280)
H	E92	60 (2.362)	96 (3.780)
H	EA5	60 (2.362)	109 (4.280)
H	EB7	60 (2.362)	121 (4.780)
H	ED0	111 (4.370)	134 (5.280)
H	EE3	111 (4.370)	147 (5.780)
H	EF5	111 (4.370)	160 (6.280)
H	EG8	111 (4.370)	172 (6.780)

Dimension	Millimeters	Inches
E	18.6 Max.	0.732 Max.
F	0.56 ± 0.05	0.022 ± 0.002
G	2.00 ± 0.13	0.080 ± 0.005
J	8.00 ± 0.13	0.315 ± 0.005
ØK	15.24 ± 0.20	0.600 ± 0.008
M	6.76 ± 0.13	0.266 ± 0.005
N	5.49 ± 0.13	0.216 ± 0.005

UTOR Series

Part Numbering System for UTOR Series When ordering, always specify complete 18-field global part number.

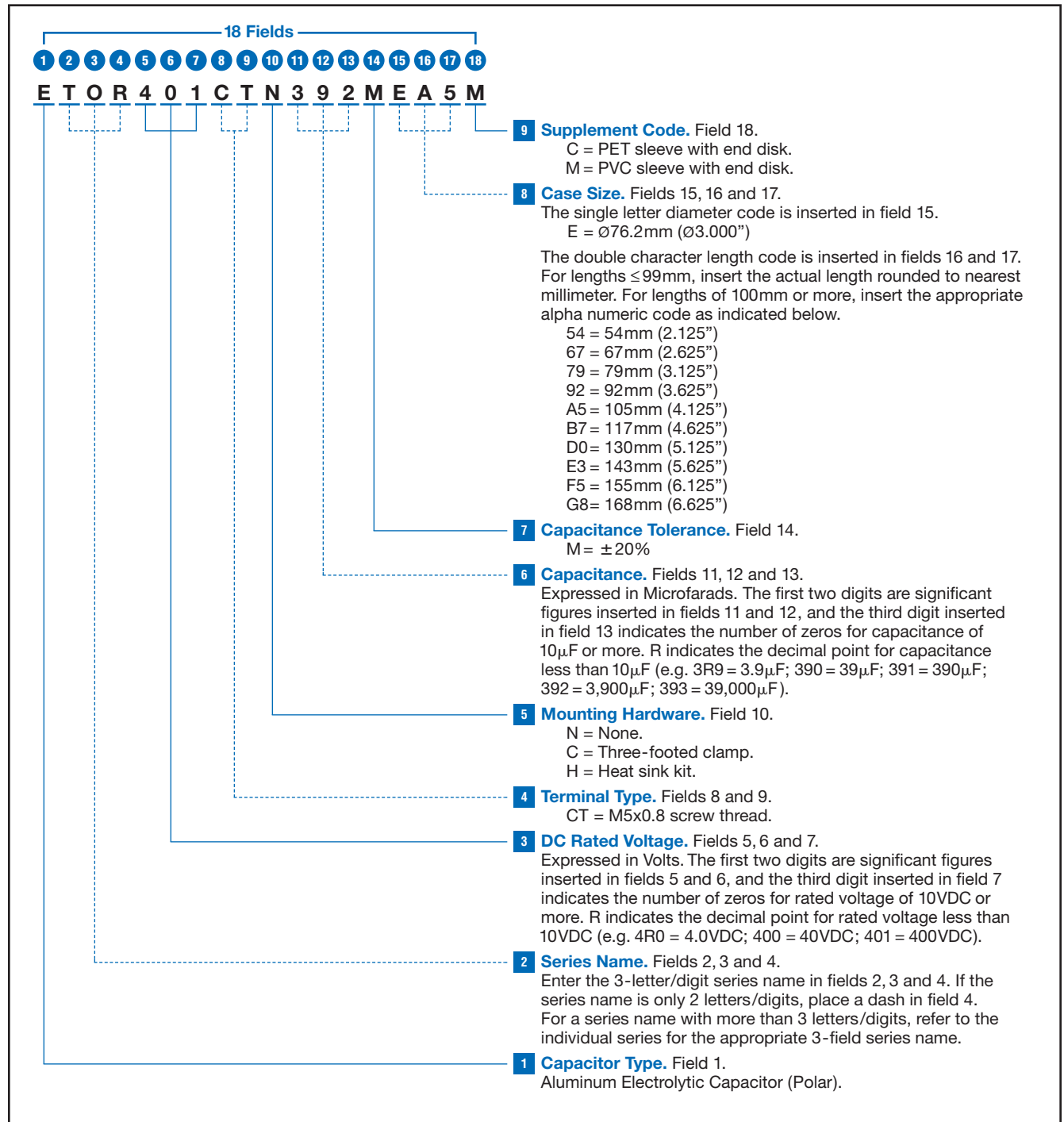

UTOR Series

Standard Voltage Ratings - Screw Terminals

Rated Voltage (WVDC)	Capacitance (µF)	Global Part Number†	Nominal Case Size* D × L (mm)	Case Size Code	Maximum ESR (mΩ) at +25°C, 120Hz	Rated Ripple Current (A rms) at +105°C		
						120Hz	300Hz	>3kHz
350 Volts 400 Volts Surge	1,800	ETOR351CTN182ME54M	76.2 × 54	E54	44	11.8	14.1	16.5
	2,700	ETOR351CTN272ME67M	76.2 × 67	E67	30	15.4	18.5	21.6
	3,300	ETOR351CTN332ME79M	76.2 × 79	E79	24	17.1	20.5	23.9
	4,700	ETOR351CTN472ME92M	76.2 × 92	E92	17	21.6	26.0	30.3
	5,600	ETOR351CTN562MEA5M	76.2 × 105	EA5	14	24.9	29.9	34.9
	6,800	ETOR351CTN682MED0M	76.2 × 130	ED0	12	30.2	36.2	42.2
	8,200	ETOR351CTN822MEE3M	76.2 × 143	EE3	10	34.5	41.4	48.3
	10,000	ETOR351CTN103MEG8M	76.2 × 168	EG8	8	41.0	49.2	57.4
400 Volts 450 Volts Surge	1,500	ETOR401CTN152ME54M	76.2 × 54	E54	53	10.7	12.9	15.0
	2,200	ETOR401CTN222ME67M	76.2 × 67	E67	36	13.9	16.7	19.5
	2,700	ETOR401CTN272ME79M	76.2 × 79	E79	30	15.4	18.5	21.6
	3,300	ETOR401CTN332ME92M	76.2 × 92	E92	24	18.1	21.8	25.4
	3,900	ETOR401CTN392MEA5M	76.2 × 105	EA5	21	20.8	25.0	29.1
	4,700	ETOR401CTN472MEB7M	76.2 × 117	EB7	17	24.0	28.8	33.6
	5,600	ETOR401CTN562MED0M	76.2 × 130	ED0	14	27.4	32.9	38.3
	6,800	ETOR401CTN682MEE3M	76.2 × 143	EE3	12	31.4	37.7	44.0
8,200	ETOR401CTN822MEG8M	76.2 × 168	EG8	10	37.1	44.5	52.0	
420 Volts 470 Volts Surge	1,200	ETOR421CTN122ME54M	76.2 × 54	E54	89	9.3	11.1	13.0
	1,800	ETOR421CTN182ME67M	76.2 × 67	E67	59	12.2	14.6	17.1
	2,200	ETOR421CTN222ME79M	76.2 × 79	E79	40	14.9	17.9	20.9
	3,300	ETOR421CTN332ME92M	76.2 × 92	E92	32	17.5	21.0	24.5
	3,900	ETOR421CTN392MEA5M	76.2 × 105	EA5	27	20.1	24.1	28.2
	4,700	ETOR421CTN472MED0M	76.2 × 130	ED0	23	24.2	29.1	33.9
	5,600	ETOR421CTN562MEE3M	76.2 × 143	EE3	19	27.6	33.1	38.6
	6,800	ETOR421CTN682MEG8M	76.2 × 168	EG8	16	32.7	39.2	45.7
450 Volts 500 Volts Surge	1,000	ETOR451CTN102ME54M	76.2 × 54	E54	89	9.3	11.1	13.0
	1,500	ETOR451CTN152ME67M	76.2 × 67	E67	59	12.2	14.6	17.1
	2,200	ETOR451CTN222ME79M	76.2 × 79	E79	48	13.5	16.2	18.9
	2,700	ETOR451CTN272ME92M	76.2 × 92	E92	40	15.9	19.0	22.2
	3,300	ETOR451CTN332MEA5M	76.2 × 105	EA5	32	18.5	22.2	25.9
	3,900	ETOR451CTN392MEB7M	76.2 × 117	EB7	27	21.1	25.3	29.6
	4,700	ETOR451CTN472MED0M	76.2 × 130	ED0	23	24.2	29.1	33.9
	5,600	ETOR451CTN562MEF5M	76.2 × 155	EF5	19	28.6	34.3	40.1
500 Volts 550 Volts Surge	680	ETOR501CTN681ME54M	76.2 × 54	E54	206	6.5	7.8	9.1
	1,000	ETOR501CTN102ME67M	76.2 × 67	E67	140	8.4	10.1	11.8
	1,500	ETOR501CTN152ME79M	76.2 × 79	E79	93	10.3	12.4	14.4
	1,800	ETOR501CTN182ME92M	76.2 × 92	E92	78	12.0	14.4	16.8
	2,200	ETOR501CTN222MEA5M	76.2 × 105	EA5	64	14.0	16.8	19.6
	2,700	ETOR501CTN272MEB7M	76.2 × 117	EB7	52	16.3	19.5	22.8
	3,300	ETOR501CTN332MEE3M	76.2 × 143	EE3	42	19.6	23.5	27.4
	3,900	ETOR501CTN392MEG8M	76.2 × 168	EG8	36	22.1	26.5	31.0

† For mounting and construction options, refer to the part numbering system for descriptions and codes.

* Refer to diagram of dimensions for detailed case size specifications.

Metric Conversion Table

Inches: Fractions/ Decimals		Inches/Millimeters												Celsius/ Fahrenheit		
		0"	1"	2"	3"	4"	5"	6"	7"	8"	9"	10"	11"	12"	°C	°F
0	—	—	25.400	50.800	76.200	101.600	127.000	152.400	177.800	203.200	228.600	254.000	279.400	304.800	538	1000
1/64	0.0156	0.397	25.797	51.197	76.597	101.997	127.397	152.797	178.197	203.597	228.997	254.397	279.797	305.197	500	932
1/32	0.0313	0.794	26.194	51.594	76.994	102.394	127.794	153.194	178.594	203.994	229.394	254.794	280.194	305.594	482	900
3/64	0.0469	1.191	26.591	51.991	77.391	102.791	128.191	153.591	178.991	204.391	229.791	255.191	280.591	305.991	450	842
1/16	0.0625	1.588	26.988	52.388	77.788	103.188	128.588	153.988	179.388	204.788	230.188	255.588	280.988	306.388	427	800
5/64	0.0781	1.984	27.384	52.784	78.184	103.584	128.984	154.384	179.784	205.184	230.584	255.984	281.384	306.784	400	752
3/32	0.0938	2.381	27.781	53.181	78.581	103.981	129.381	154.781	180.181	205.581	230.981	256.381	281.781	307.181	371	700
7/64	0.1094	2.778	28.178	53.578	78.978	104.378	129.778	155.178	180.578	205.978	231.378	256.778	282.178	307.578	350	662
1/8	0.125	3.175	28.575	53.975	79.375	104.775	130.175	155.575	180.975	206.375	231.775	257.175	282.575	307.975	316	600
9/64	0.1406	3.572	28.972	54.372	79.772	105.172	130.572	155.972	181.372	206.772	232.172	257.572	282.972	308.372	300	572
5/32	0.1563	3.969	29.369	54.769	80.169	105.569	130.969	156.369	181.769	207.169	232.569	257.969	283.369	308.769	260	500
11/64	0.1719	4.366	29.766	55.166	80.566	105.966	131.366	156.766	182.166	207.566	232.966	258.366	283.766	309.166	250	482
3/16	0.1875	4.762	30.162	55.562	80.962	106.362	131.762	157.162	182.562	207.962	233.362	258.762	284.162	309.562	204	400
13/64	0.2031	5.159	30.559	55.959	81.359	106.759	132.159	157.559	182.959	208.359	233.759	259.159	284.559	309.959	200	392
7/32	0.2188	5.556	30.956	56.356	81.756	107.156	132.556	157.956	183.356	208.756	234.156	259.556	284.956	310.356	190	374
15/64	0.2344	5.953	31.353	56.753	82.153	107.553	132.953	158.353	183.753	209.153	234.553	259.953	285.353	310.753	180	356
1/4	0.250	6.350	31.750	57.150	82.550	107.950	133.350	158.750	184.150	209.550	234.950	260.350	285.750	311.150	170	338
17/64	0.2656	6.747	32.147	57.547	82.947	108.347	133.747	159.147	184.547	209.947	235.347	260.747	286.147	311.547	160	320
9/32	0.2813	7.144	32.544	57.944	83.344	108.744	134.144	159.544	184.944	210.344	235.744	261.144	286.544	311.944	150	302
19/64	0.2969	7.541	32.941	58.341	83.741	109.141	134.541	159.941	185.341	210.741	236.141	261.541	286.941	312.341	140	284
5/16	0.3125	7.938	33.338	58.738	84.138	109.538	134.938	160.338	185.738	211.138	236.538	261.938	287.338	312.738	130	266
21/64	0.3281	8.334	33.734	59.134	84.534	109.934	135.334	160.734	186.134	211.534	236.934	262.334	287.734	313.134	125	257
11/32	0.3438	8.731	34.131	59.531	84.931	110.331	135.731	161.131	186.531	211.931	237.331	262.731	288.131	313.531	120	248
23/64	0.3594	9.128	34.528	59.928	85.328	110.728	136.128	161.528	186.928	212.328	237.728	263.128	288.528	313.928	110	230
3/8	0.375	9.525	34.925	60.325	85.725	111.125	136.525	161.925	187.325	212.725	238.125	263.525	288.925	314.325	105	221
25/64	0.3906	9.922	35.322	60.722	86.122	111.522	136.922	162.322	187.722	213.122	238.522	263.922	289.322	314.722	100	212
13/32	0.4063	10.319	35.719	61.119	86.519	111.919	137.319	162.719	188.119	213.519	238.919	264.319	289.719	315.119	95	203
27/64	0.4219	10.716	36.116	61.516	86.916	112.316	137.716	163.116	188.516	213.916	239.316	264.716	290.116	315.516	90	194
7/16	0.4375	11.112	36.512	61.912	87.312	112.712	138.112	163.512	188.912	214.312	239.712	265.112	290.512	315.912	85	185
29/64	0.4531	11.509	36.909	62.309	87.709	113.109	138.509	163.909	189.309	214.709	240.109	265.509	290.909	316.309	80	176
15/32	0.4688	11.906	37.306	62.706	88.106	113.506	138.906	164.306	189.706	215.106	240.506	265.906	291.306	316.706	75	167
31/64	0.4844	12.303	37.703	63.103	88.503	113.903	139.303	164.703	190.103	215.503	240.903	266.303	291.703	317.103	70	158
1/2	0.500	12.700	38.100	63.500	88.900	114.300	139.700	165.100	190.500	215.900	241.300	266.700	292.100	317.500	65	149
33/64	0.5156	13.097	38.497	63.897	89.297	114.697	140.097	165.497	190.897	216.297	241.697	267.097	292.497	317.897	60	140
17/32	0.5313	13.494	38.894	64.294	89.694	115.094	140.494	165.894	191.294	216.694	242.094	267.494	292.894	318.294	55	131
35/64	0.5469	13.891	39.291	64.691	90.091	115.491	140.891	166.291	191.691	217.091	242.491	267.891	293.291	318.691	50	122
9/16	0.5625	14.288	39.688	65.088	90.488	115.888	141.288	166.688	192.088	217.488	242.888	268.288	293.688	319.088	45	113
37/64	0.5781	14.684	40.084	65.484	90.884	116.284	141.684	167.084	192.484	217.884	243.284	268.684	294.084	319.484	40	104
19/32	0.5938	15.081	40.481	65.881	91.281	116.681	142.081	167.481	192.881	218.281	243.681	269.081	294.481	319.881	35	95
39/64	0.6094	15.478	40.878	66.278	91.678	117.078	142.478	167.878	193.278	218.678	244.078	269.478	294.878	320.278	30	86
5/8	0.625	15.875	41.275	66.675	92.075	117.475	142.875	168.275	193.675	219.075	244.475	269.875	295.275	320.675	25	77
41/64	0.6406	16.272	41.672	67.072	92.472	117.872	143.272	168.672	194.072	219.472	244.872	270.272	295.672	321.072	20	68
21/32	0.6563	16.669	42.069	67.469	92.869	118.269	143.669	169.069	194.469	219.869	245.269	270.669	296.069	321.469	15	59
43/64	0.6719	17.066	42.466	67.866	93.266	118.666	144.066	169.466	194.866	220.266	245.666	271.066	296.466	321.866	10	50
11/16	0.6875	17.462	42.862	68.262	93.662	119.062	144.462	169.862	195.262	220.662	246.062	271.462	296.862	322.262	5	41
45/64	0.7031	17.859	43.259	68.659	94.059	119.459	144.859	170.259	195.659	221.059	246.459	271.859	297.259	322.659	0	32
23/32	0.7188	18.256	43.656	69.056	94.456	119.856	145.256	170.656	196.056	221.456	246.856	272.256	297.656	323.056	- 5.0	23
47/64	0.7344	18.653	44.053	69.453	94.853	120.253	145.653	171.053	196.453	221.853	247.253	272.653	298.053	323.453	- 10.0	14
3/4	0.750	19.050	44.450	69.850	95.250	120.650	146.050	171.450	196.850	222.250	247.650	273.050	298.450	323.850	- 15.0	5
49/64	0.7656	19.447	44.847	70.247	95.647	121.047	146.447	171.847	197.247	222.647	248.047	273.447	298.847	324.247	- 17.8	0
25/32	0.7813	19.844	45.244	70.644	96.044	121.444	146.844	172.244	197.644	223.044	248.444	273.844	299.244	324.644	- 20.0	- 4
51/64	0.7969	20.241	45.641	71.041	96.441	121.841	147.241	172.641	198.041	223.441	248.841	274.241	299.641	325.041	- 20.6	- 5
13/16	0.8125	20.638	46.038	71.438	96.838	122.238	147.638	173.038	198.438	223.838	249.238	274.638	300.038	325.438	- 23.3	- 10
53/64	0.8281	21.034	46.434	71.834	97.234	122.634	148.034	173.434	198.834	224.234	249.634	275.034	300.434	325.834	- 25.0	- 13
27/32	0.8438	21.431	46.831	72.231	97.631	123.031	148.431	173.831	199.231	224.631	250.031	275.431	300.831	326.231	- 26.1	- 15
55/64	0.8594	21.828	47.228	72.628	98.028	123.428	148.828	174.228	199.628	225.028	250.428	275.828	301.228	326.628	- 28.9	- 20
7/8	0.875	22.225	47.625	73.025	98.425	123.825	149.225	174.625	200.025	225.425	250.825	276.225	301.625	327.025	- 30.0	- 22
57/64	0.8906	22.622	48.022	73.422	98.822	124.222	149.622	175.022	200.422	225.822	251.222	276.622	302.022	327.422	- 31.7	- 25
29/32	0.9063	23.019	48.419	73.819	99.219	124.619	150.019	175.419	200.819	226.219	251.619	277.019	302.419	327.819	- 34.4	- 30
59/64	0.9219	23.416	48.816	74.216	99.616	125.016	150.416	175.816	201.216	226.616	252.016	277.416	302.816	328.216	- 35.0	- 31
15/16	0.9375	23.812	49.212	74.612	100.012	125.412	150.812	176.212	201.612	227.012	252.412	277.812	303.212	328.612	- 37.2	- 35
61/64	0.9531	24.209	49.609	75.009	100.409	125.809	151.209	176.609	202.009	227.409	252.809	278.209	303.609	329.009	- 40.0	- 40
31/32	0.9688	24.606	50.006	75.406	100.806	126.206	151.606	177.006	202.406	227.806						

Corporate Office

1701 Golf Road 1-1200, Rolling Meadows, Illinois 60008
Phone 847-696-2000 Fax 847-696-9278

Western Regional Sales Office

5651 Dolly Avenue, Buena Park, California 90621
Phone 714-255-9500 Fax 714-256-1328

Southeastern Regional Sales Office

7501 Memorial Parkway SW, Suite 209, Huntsville, Alabama 35801
Phone 256-489-9385 Fax 256-489-9387

Internet: www.chemi-con.com

E-Mail: info@chemi-con.com

For further information, please contact:



UNITED CHEMI-CON, INC.

Representing North America, United Chemi-Con is a wholly owned subsidiary of Nippon Chemi-Con.