

Screw and gasket,
see sheet 2, PN Key

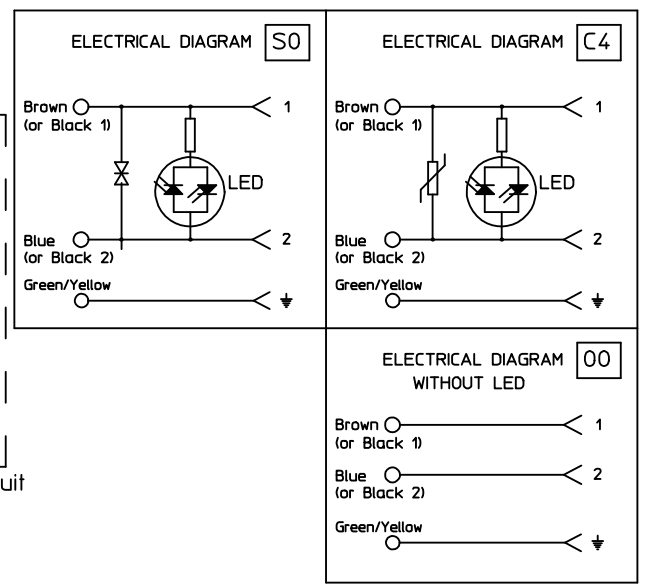
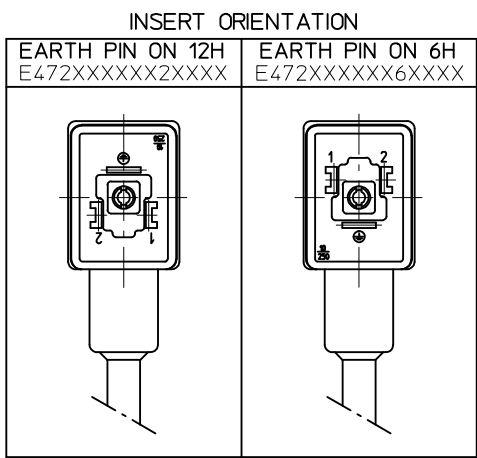
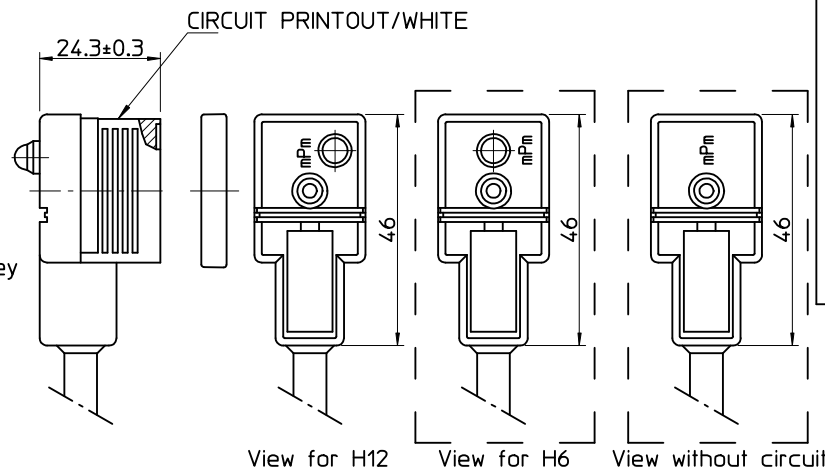

Table of length tolerances [mm]

| Over | Up to and including | Tolerance (+) |
|-------|---------------------|---------------|
| 0 | 1000 | ±20 |
| 1000 | 3000 | ±30 |
| 3000 | 5000 | ±40 |
| 5000 | 10000 | ±50 |
| 10000 | 15000 | ±100 |
| 15000 | 20000 | ±150 |
| 20000 | | ±L/100 |

| | | | | | | | |
|--|--|--|--|---|--|-------------------------------|---------------------|
| DRAWING UPDATE EC NO: IPG2013-1497 DRW: JMARSZALEK 2013/03/27 CHK: MDYSZEWSKA 2013/03/27 APPR: MIWASIECZKO 2013/03/28 | QUALITY SYMBOLS ▽=0 ▽=0 | GENERAL TOLERANCES (UNLESS SPECIFIED) mm INCH 4 PLACES ±--- ±--- 3 PLACES ±--- ±--- 2 PLACES ±--- ±--- 1 PLACE ±--- ±--- 0 PLACE ±--- ±--- ANGULAR ±---° | DIMENSION STYLE MM ONLY DRAWN BY: JMARSZALEK DATE: 2012/11/19 CHECKED BY: MSZWAJKOWSKI DATE: 2012/11/20 APPROVED BY: MIWASIECZKO DATE: 2013/02/12 MATERIAL NO. | SCALE DESIGN UNITS METRIC FIRST ANGLE PROJECTION | TITLE E472XXXXXXXXXXXX FORM B EN 175301-803 molex | DOCUMENT NO. SD-121050-005 | SHEET NO. 1 OF 4 |
| | DRAFT WHERE APPLICABLE MUST REMAIN WITHIN DIMENSIONS | SEE SHEET 2&3 | THIS DRAWING CONTAINS INFORMATION THAT IS PROPRIETARY TO MOLEX INCORPORATED AND SHOULD NOT BE USED WITHOUT WRITTEN PERMISSION | | | | |
| | REV B | | | | | | |
| | | | | | | | |

10 9 8 7 6 5 4 3 2 1

F

F

E

E

D

D

C

C



B

B

A

A

9 8 7 6 5 4 3 2 1

| | | | | | | | | | | |
|--|--------------------|---|--|--|---|--|--|-------------------------------|---|----------------------------|
| DRAWING UPDATE EC NO: IPG2013-1497 DRWN: JMARSZALEK 2013/03/27 CHKD: MDYSZEWSKA 2013/03/27 APPR: MIWASIECZKO 2013/03/28 | DESCRIPTION REV | QUALITY SYMBOLS  = 0  = 0 | GENERAL TOLERANCES (UNLESS SPECIFIED) | | DIMENSION STYLE MM ONLY | | SCALE 1:1 | DESIGN UNITS METRIC |  FIRST ANGLE PROJECTION | |
| | | 4 PLACES ± --- ± --- 3 PLACES ± --- ± --- 2 PLACES ± --- ± --- 1 PLACE ± --- ± --- 0 PLACE ± --- ± --- ANGULAR ± --- ° | mm INCH | DRAWN BY DATE JMARSZALEK 2012/11/19 CHECKED BY DATE MSZWAJKOWSKI 2012/11/20 APPROVED BY DATE MIWASIECZKO 2013/02/12 | TITLE E472XXXXXXXXXXXX FORM B EN 175301-803 | | MATERIAL NO. SEE SHEET 2&4 | | DOCUMENT NO. SD-121050-005 | SHEET NO. 2 OF 4 |
| DRAFT WHERE APPLICABLE MUST REMAIN WITHIN DIMENSIONS | | | THIS DRAWING CONTAINS INFORMATION THAT IS PROPRIETARY TO MOLEX INCORPORATED AND SHOULD NOT BE USED WITHOUT WRITTEN PERMISSION | | | | | | | |



10 | 9 | 8 | 7 | 6 | 5 | 4 | 3 | 2 | 1

F

F

E

E

D

D

C





C

B

B

A

A

| | | | | | | | | | | |
|--|--------------------|--|--|--|---|--|---|-------------------------------|---|--|
| DRAWING UPDATE EC NO: IPG2013-1497 DRWN: JMARSZALEK 2013/03/27 CHKD: MDYSZEWSKA 2013/03/27 APPR: MIWASIECZKO 2013/03/28 | DESCRIPTION REV | QUALITY SYMBOLS  = 0  = 0.05 | GENERAL TOLERANCES (UNLESS SPECIFIED) | | DIMENSION STYLE MM ONLY | | SCALE 1:1 | DESIGN UNITS METRIC |  FIRST ANGLE PROJECTION | |
| | | 4 PLACES ± --- ± --- 3 PLACES ± --- ± --- 2 PLACES ± --- ± --- 1 PLACE ± --- ± --- 0 PLACE ± --- ± --- ANGULAR ± --- ° | mm INCH | DRAWN BY DATE JMARSZALEK 2012/11/19 | TITLE E472XXXXXXXXXXXX FORM B EN 175301-803 | | | | | |
| DRAFT WHERE APPLICABLE MUST REMAIN WITHIN DIMENSIONS | | | CHECKED BY DATE MSZWAJKOWSKI 2012/11/20 | | APPROVED BY DATE MIWASIECZKO 2013/02/12 | | DOCUMENT NO. SD-121050-005 | | SHEET NO. 3 OF 4 | |
| | | | SEE SHEET 2&4 | | MATERIAL NO. | | THIS DRAWING CONTAINS INFORMATION THAT IS PROPRIETARY TO MOLEX INCORPORATED AND SHOULD NOT BE USED WITHOUT WRITTEN PERMISSION | |  | |

9 | 8 | 7 | 6 | 5 | 4 | 3 | 2 | 1

10 | 9 | 8 | 7 | 6 | 5 | 4 | 3 | 2 | 1

F

F

E

E

D

D

C

C



B

B

A

A

9 | 8 | 7 | 6 | 5 | 4 | 3 | 2 | 1

| | | | | | | | | | | |
|--|--------------------|---|--|--|---|--|--|-------------------------------|---|----------------------------|
| DRAWING UPDATE EC NO: IPG2013-1497 DRWN: JMARSZALEK 2013/03/27 CHKD: MDYSZEWSKA 2013/03/27 APPR: MIWASIECZKO 2013/03/28 | DESCRIPTION REV | QUALITY SYMBOLS  = 0  = 0 | GENERAL TOLERANCES (UNLESS SPECIFIED) | | DIMENSION STYLE MM ONLY | | SCALE 1:1 | DESIGN UNITS METRIC |  FIRST ANGLE PROJECTION | |
| | | 4 PLACES ± --- ± --- 3 PLACES ± --- ± --- 2 PLACES ± --- ± --- 1 PLACE ± --- ± --- 0 PLACE ± --- ± --- ANGULAR ± --- ° | mm INCH | DRAWN BY DATE JMARSZALEK 2012/11/19 CHECKED BY DATE MSZWAJKOWSKI 2012/11/20 APPROVED BY DATE MIWASIECZKO 2013/02/12 | TITLE E472XXXXXXXXXXXX FORM B EN 175301-803 | | MATERIAL NO. SEE SHEET 2&4 | | DOCUMENT NO. SD-121050-005 | SHEET NO. 4 OF 4 |
| DRAFT WHERE APPLICABLE MUST REMAIN WITHIN DIMENSIONS | | | THIS DRAWING CONTAINS INFORMATION THAT IS PROPRIETARY TO MOLEX INCORPORATED AND SHOULD NOT BE USED WITHOUT WRITTEN PERMISSION | | | | | | | |

