

# CYLINDRICAL PHOTOELECTRIC SENSORS

**E3FA/E3RA: M18 Plastic Housing**

**E3FB/E3RB: M18 Metal Housing**



- » Simplicity in setup & installation
- » Standard & special applications
- » Robust waterproof housing

# M18 Plastic and Metal Housing Sensors

Omron's next generation of photoelectric sensors represents one of the largest varieties of dependable and easy-to-use photoelectric sensors on the market. Regardless of your industry or application, the E3FA/E3RA/E3FB/E3RB series is the right sensor for the job.

## Key Features

- » Universal M18 cylindrical plastic or nickel-plated brass housing in straight or 90° angled (radial) models
- » Rugged IP67, IP69K housing withstands high-pressure and high-temperature wash down
- » Bright LED indicators provide status visibility from almost any angle
- » High power red LED for easy sensor alignment and dependable outputs in dusty environments
- » All retro reflective models are polarized to prevent false reads on mirrored surfaces
- » High EMC protection and ambient light immunity for detection stability in environments with excess noise or background light
- » Compact size and shape for increased installation flexibility



**Full line-up of sensors to increase mounting flexibility and meet the needs of a wide range of applications.**

## Unrivalled Detection with Simplicity in Setup and Installation

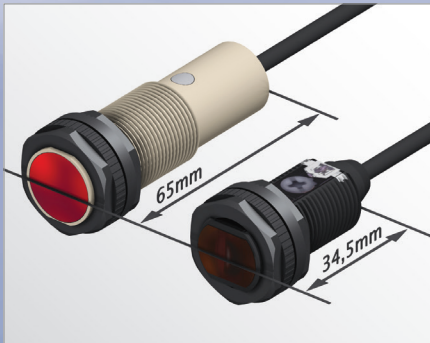

The short body of the E3FA/E3RA fits in tighter mounting spaces.



Visible red LED light for easy alignment.

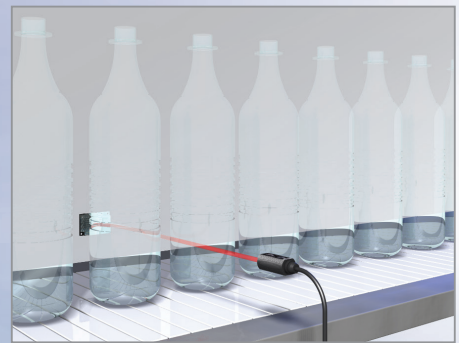

Transparent object detection sensors utilize Omron's unique technology for detecting objects with birefringent (double refraction) properties.



Bright LED indicators for status visibility and large sensor adjusters for use with a standard size screwdriver.

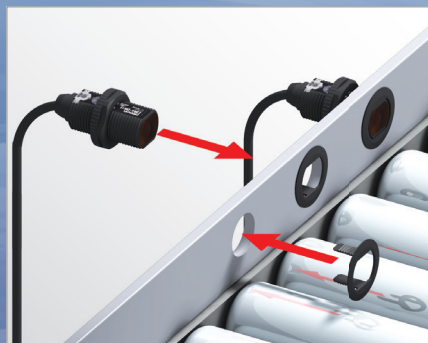

Flush mounting option for quick and easy installation.



High power LED to compensate for dirt and misalignment.

# One Family for All Applications

## Special Models

The E3FA/E3FB series includes special models to solve challenging applications.

- » Background Suppression
- » Limited Distance Detection
- » Transparent Object Detection

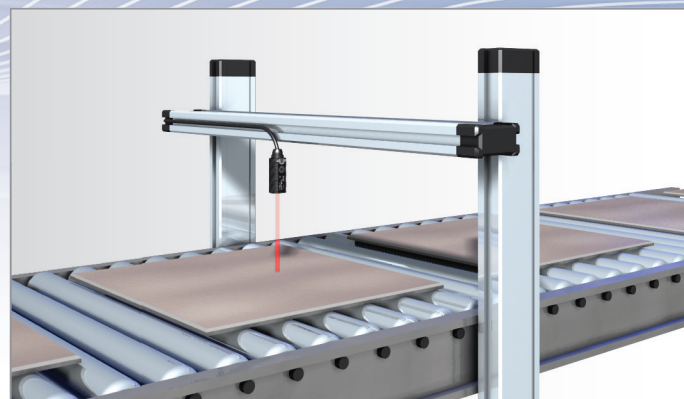

Background suppression sensors for stable detection independent of color or background.

## Ordering Information

### E3FA/E3RA Plastic Housing Sensors

Setup	Sensor type		Sensing distance	PNP		NPN	
				Pre-wired (2m)	M12 connector	Pre-wired (2m)	M12 connector
Straight		Through-beam *1	20m	E3FA-TP11 2M	E3FA-TP21	E3FA-TN11 2M	E3FA-TN21
		Retro-reflective (using reflector E39-R1S sold separately.)	0.1 to 4m	E3FA-RP11 2M	E3FA-RP21	E3FA-RN11 2M	E3FA-RN21
		Retro-reflective (coaxial) (using reflector E39-R1S sold separately.)	0 to 500mm	E3FA-RP12 2M	E3FA-RP22	E3FA-RN12 2M	E3FA-RN22
		Diffuse-reflective	100mm	E3FA-DP11 2M	E3FA-DP21	E3FA-DN11 2M	E3FA-DN21
	300mm		E3FA-DP12 2M	E3FA-DP22	E3FA-DN12 2M	E3FA-DN22	
	1m		E3FA-DP13 2M	E3FA-DP23	E3FA-DN13 2M	E3FA-DN23	
Special Applications		BGS (Background suppression)	100mm	E3FA-LP11 2M	E3FA-LP21	E3FA-LN11 2M	E3FA-LN21
			200mm	E3FA-LP12 2M	E3FA-LP22	E3FA-LN12 2M	E3FA-LN22
		Limited distance reflective	10 to 50mm	E3FA-VP11 2M	E3FA-VP21	E3FA-VN11 2M	E3FA-VN21
		Transparent detection (using reflector E39-RP1 sold separately.)	100 to 500mm	E3FA-BP11 2M	E3FA-BP21	E3FA-BN11 2M	E3FA-BN21
			0.1 to 2m	E3FA-BP12 2M	E3FA-BP22	E3FA-BN12 2M	E3FA-BN22
Radial		Through-beam *1	15m	E3RA-TP11 2M	E3RA-TP21	E3RA-TN11 2M	E3RA-TN21
		Retro-reflective (using reflector E39-R1S sold separately.)	0.1 to 3m	E3RA-RP11 2M	E3RA-RP21	E3RA-RN11 2M	E3RA-RN21
		Diffuse-reflective	100mm	E3RA-DP11 2M	E3RA-DP21	E3RA-DN11 2M	E3RA-DN21
			300mm	E3RA-DP12 2M	E3RA-DP22	E3RA-DN12 2M	E3RA-DN22
700mm			E3RA-DP13 2M	E3RA-DP23	E3RA-DN13 2M	E3RA-DN23	

\*1 The set type includes the emitter and receiver.

Note: All sensors are 10-30 VDC. Light-On/Dark-On selectable by wiring.







Note: Please reference the data sheet for infrared emitter options for through-beam and diffuse type E3FA sensors.

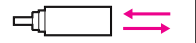
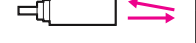

Use this document as a guide to find the right E3 series sensor for your application. Enter the **Quick Link Code** in the Search Center of the Omron website ([www.omron247.com](http://www.omron247.com)) to download comprehensive E3 series product documentation such as datasheets, brochures, manuals and CAD files.

# Ordering Information

## E3FB/E3RB Metal Housing Sensors

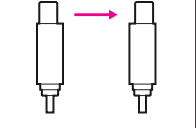
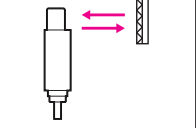
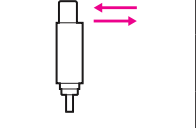
Setup	Sensor type		Sensing distance	PNP		NPN	
				Pre-wired (2m)	M12 connector	Pre-wired (2m)	M12 connector
Straight		Through-beam *1	20m	E3FB-TP11 2M	E3FB-TP21	E3FB-TN11 2M	E3FB-TN21
		Retro-reflective *2 (using reflector E39-R1S sold separately.)	0.1 to 4m	E3FB-RP11 2M	E3FB-RP21	E3FB-RN11 2M	E3FB-RN21
		Coaxial Retro-reflective *2 (using reflector E39-R1S sold separately.)	0 to 500mm	E3FB-RP12 2M	E3FB-RP22	E3FB-RN12 2M	E3FB-RN22
		Diffuse-reflective	100mm	E3FB-DP11 2M	E3FB-DP21	E3FB-DN11 2M	E3FB-DN21
			300mm	E3FB-DP12 2M	E3FB-DP22	E3FB-DN12 2M	E3FB-DN22
			1m	E3FB-DP13 2M	E3FB-DP23	E3FB-DN13 2M	E3FB-DN23
Special Applications		BGS (background suppression)	100mm	E3FB-LP11 2M	E3FB-LP21	E3FB-LN11 2M	E3FB-LN21
			200mm	E3FB-LP12 2M	E3FB-LP22	E3FB-LN12 2M	E3FB-LN22
		Limited distance reflective	10 to 50mm	E3FB-VP11 2M	E3FB-VP21	E3FB-VN11 2M	E3FB-VN21
		Transparent detected with P-opaqing function *2	100 to 500mm with E39-RP1	E3FB-BP11 2M	E3FB-BP21	E3FB-BN11 2M	E3FB-BN21
		Transparent detected with P-opaqing function *2	0.1 to 2m with E39-RP1	E3FB-BP12 2M	E3FB-BP22	E3FB-BN12 2M	E3FB-BN22
Radial		Through-beam	15m	E3RB-TP11 2M	E3RB-TP21	E3RB-TN11 2M	E3RB-TN21
		Retro-reflective *2 (using reflector E39-R1S sold separately.)	0.1 to 3m with E39-R1S	E3RB-RP11 2M	E3RB-RP21	E3RB-RN11 2M	E3RB-RN21
		Diffuse reflective	100mm	E3RB-DP11 2M	E3RB-DP21	E3RB-DN11 2M	E3RB-DN21
			300mm	E3RB-DP12 2M	E3RB-DP22	E3RB-DN12 2M	E3RB-DN22
			700mm	E3RB-DP13 2M	E3RB-DP23	E3RB-DN13 2M	E3RB-DN23

\*1 The set type includes the emitter and receiver.



Note: All sensors are 10-30 VDC. Light-On/Dark-On selectable by wiring.



# Accessories



## Reflectors

**Reflectors required for Retro-reflective Sensors: A Reflector is not provided with the Sensor. Be sure to order a Reflector separately.**

Sensor	Sensing distance	Appearance	Model	Quantity	Remarks
E3FA-R□1 E3FB-R□1	0.1 to 4 m		<b>E39-R1S</b>	1	for E3FA-R□, E3RA-R□, for E3FB-R□ and E3RB-R□
E3FA-R□2 E3FB-R□2	0 to 500 mm				
E3FA-B□1 E3FB-B□1	100 to 500 mm		<b>E39-RP1</b>	1	for E3FA-B□ and E3FB-B□
E3FA-B□2 E3FB-B□2	0.1 to 2 m				

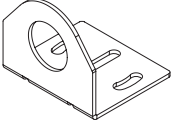

## Mounting Brackets

**A Mounting Bracket is not included with the Sensor. Order a Mounting Bracket separately if required.**

Sensor	Appearance	Model (Material)	Quantity	Remarks
All types		<b>E39-L183</b> (SUS304)	1	Mounting bracket
E3FA-□ E3RA-□		<b>E39-L182</b> (POM)	1	Flush mounting bracket

## Sensor I/O connectors

**Models for Connectors: A Connector is not provided with the Sensor. Be sure to order a Connector separately.**

Sensor	Size	Cable	Appearance	Cable Type	Remarks	
M12 connector types	M12	Standard	Straight 	2 m	4-wire XS2F-M12PVC4S2M	
				5 m		XS2F-M12PVC4S5M
			Angle 	2 m		XS2F-M12PVC4A2M
				5 m		XS2F-M12PVC4A5M



**OMRON AUTOMATION AND SAFETY • THE AMERICAS HEADQUARTERS** • Hoffman Estates, IL USA • 847.843.7900 • 800.556.6766 • [www.omron247.com](http://www.omron247.com)

**OMRON CANADA, INC. • HEAD OFFICE**

Toronto, ON, Canada • 416.286.6465 • 866.986.6766 • [www.omron247.com](http://www.omron247.com)

**OMRON ELECTRONICS DE MEXICO • HEAD OFFICE**

México DF • 52.55.59.01.43.00 • 01-800-226-6766 • [mela@omron.com](mailto:mela@omron.com)

**OMRON ELECTRONICS DE MEXICO • SALES OFFICE**

Apodaca, N.L. • 52.81.11.56.99.20 • 01-800-226-6766 • [mela@omron.com](mailto:mela@omron.com)

**OMRON ELETRÔNICA DO BRASIL LTDA • HEAD OFFICE**

São Paulo, SP, Brasil • 55.11.2101.6300 • [www.omron.com.br](http://www.omron.com.br)

**OMRON ARGENTINA • SALES OFFICE**

Cono Sur • 54.11.4783.5300

**OMRON CHILE • SALES OFFICE**

Santiago • 56.9.9917.3920

**OTHER OMRON LATIN AMERICA SALES**

54.11.4783.5300

**OMRON EUROPE B.V.** • Wegalaan 67-69, NL-2132 JD, Hoofddorp, The Netherlands. • +31 (0) 23 568 13 00 • [www.industrial.omron.eu](http://www.industrial.omron.eu)

*Authorized Distributor:*

**Automation Control Systems**

- Machine Automation Controllers (MAC) • Programmable Controllers (PLC)
- Operator interfaces (HMI) • Distributed I/O • Software

**Drives & Motion Controls**

- Servo & AC Drives • Motion Controllers & Encoders

**Temperature & Process Controllers**

- Single and Multi-loop Controllers

**Sensors & Vision**

- Proximity Sensors • Photoelectric Sensors • Fiber-Optic Sensors
- Amplified Photomicrosensors • Measurement Sensors
- Ultrasonic Sensors • Vision Sensors

**Industrial Components**

- RFID/Code Readers • Relays • Pushbuttons & Indicators
- Limit and Basic Switches • Timers • Counters • Metering Devices
- Power Supplies

**Safety**

- Laser Scanners • Safety Mats • Edges and Bumpers • Programmable Safety Controllers • Light Curtains • Safety Relays • Safety Interlock Switches