

20 Watts

- Regulated single outputs from 24VDC to 48VDC
- Wide 4:1 input range
- Fully encapsulated chassis mount
- Optional DIN rail version
- IEC/UL/cUL62368-1 safety approvals
- EN55032 class A with no external components
- Remote on/off
- 2.5kVDC isolation
- -40°C to +95°C operating temperature
- Full power to 80°C
- MTBF 750kHrs (MIL-DHBK-27F, +25°C GB)
- 3 year warranty



Dimensions:

DTE20:

3.78 x 2.13 x 0.92" (96.0 x 54.0 x 23.3 mm)

Available in two wide (4:1) input ranges for nominal 24VDC and 48VDC, the DTE20 series of encapsulated 20W DC-DC converters are chassis mount as standard or can be ordered with a DIN rail mount. They have screw terminals for ease of connection and an LED provides clear 'power good' indication. Remote On/Off is standard and when inhibited the standby current is just 3mA. Isolation is 2.5kVDC input/output providing excellent separation between supply and load. The modules are fully protected against input undervoltage, short circuit and overload conditions. These features, along with a rugged design and wide operating temperature range make the DTE20 series suitable for a variety of commercial and industrial applications.

Models & Ratings

Input Voltage	Output Voltage	Output Current	Input Current ^(1,4)		Maximum Capacitive Load	Efficiency ⁽²⁾	Model Number ⁽³⁾
			No Load	Full Load			
24 V (9-36 V)	5.1 V	4.0 A	70 mA	0.94 A	6800 µF	90%	DTE2024S5V1
	12.0 V	1.67 A	70 mA	0.92 A	1160 µF	91%	DTE2024S12
	24.0 V	0.835 A	70 mA	0.92 A	300 µF	91%	DTE2024S24
	48.0 V	0.42 A	70 mA	0.94 A	75 µF	89%	DTE2024S48
48 V (18-75 V)	5.1 V	4.0 A	35 mA	0.47 A	6800 µF	90%	DTE2048S5V1
	12.0 V	1.67 A	35 mA	0.46 A	1160 µF	91%	DTE2048S12
	24.0 V	0.835 A	35 mA	0.46 A	300 µF	91%	DTE2048S24
	48.0 V	0.42 A	35 mA	0.47 A	75 µF	89%	DTE2048S48

Notes

1. Input current measured at nominal input voltage.
2. Typical values.
3. For optional version fitted with Din Clip add suffix '-D' e.g. DTE2024S24-D.
4. Input current is typically 3 mA at nominal input voltage when output is remotely turned off.

Mechanical Details

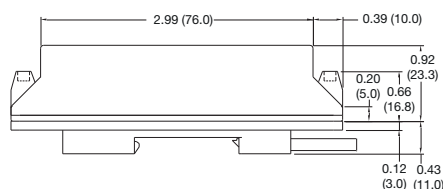
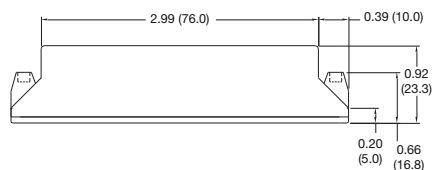
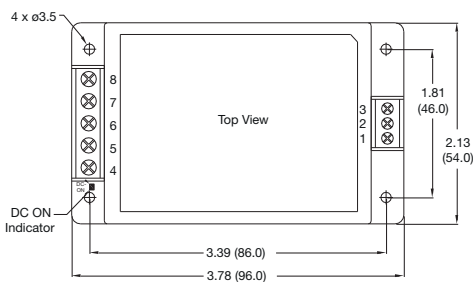

Pin Connections	
Pin	Function
1	Remote On/Off
2	-Vin
3	+Vin
4	No Connection
5	-Vout
6	No Connection
7	+Vout
8	No Connection

Notes

1. All dimensions are in inches (mm)
2. Weight: 0.214 lbs (107 g) approx
3. Weight for -D version: 0.332 lbs (166 g) approx
4. Terminal wire size 1.5 mm² max
5. Screw terminal torque 4.5 to 6.2 lb-in (0.5 to 0.7 Nm)
6. Case tolerance: ±0.02 (±0.5)

Input

Characteristic	Minimum	Typical	Maximum	Units	Notes & Conditions
Input Voltage Range	9		36	VDC	24 V nominal
	18		75	VDC	48 V nominal
Input Current					See Models and Ratings table
Inrush Current				A	
Input Filter	Pi type				
Undervoltage Lockout	On at >9 V. Off <7.5 V				24 V models
	On at >18 V. Off <16.0 V				48 V models
Input Surge			50	VDC	24 V models for 100 ms
			100	VDC	48 V models for 100 ms
Remote On/Off	On: Logic High (3.5-12 V) or open circuit				
	Off: Logic Low (<1.2 V) or short pin 1 to pin 2				

Output

Characteristic	Minimum	Typical	Maximum	Units	Notes & Conditions
Output Voltage	5.1		48	V	See Models and Ratings table
Initial Set Accuracy		±1	±2	%	
Minimum Load	0			A	No minimum load required
Start Up Delay		50		ms	
Line Regulation		±0.5		%	
Load Regulation		1		%	0 - 10% load
Transient Response			5	% deviation	Recovery to within 1% in <250 µs for a 50% load change at 0.25 A/µs rate
Ripple & Noise			100 150 200	mV pk-pk	5.1 V model, 20 MHz bandwidth 12 V & 48 V models, 20 MHz bandwidth 48 V model, 20 MHz bandwidth
Short Circuit Protection					Trip & Restart (hiccup mode), auto recovery
Overload Protection		150		%	Trip & Restart (hiccup mode)
Overvoltage Protection		120		%	Zener diode clamp
Temperature Coefficient			0.02	%/°C	

General

Characteristic	Minimum	Typical	Maximum	Units	Notes & Conditions
Efficiency		90		%	See Models and Ratings table
Isolation	2500			VDC	For 60 s, functional insulation
Isolation Resistance	1000			MΩ	At 500 VDC
Input to Output Capacitance			2200	pF	
Switching Frequency		285		kHz	
Power Density			2.7	W/in ³	
Mean Time Between Failure	750			kHrs	MIL-HDBK-217F, +25 °C GB
Weight		0.214 (107)		lb (g)	

Environmental

Characteristic	Minimum	Typical	Maximum	Units	Notes & Conditions
Operating Temperature	-40		+95	°C	See derating curve
Storage Temperature	-50		+125	°C	
Case Temperature			95	°C	
Thermal Impedance (Case to Ambient)	3.9			°C/W	Natural convection
	3.3				100 LFM
	3.1				200 LFM
	2.5				400 LFM
Humidity	5		95	%RH	Non-condensing
Cooling					Natural convection
Shock	±3 shocks in each plane, total 18 shocks of 30 g : 11 ms halfsine. Conforms to EN60068-2-27 & EN60068-2-47				
Vibration	10-500 Hz at 2 g sweep and endurance at resonance in all 3 planes. Conforms to EN60068-2-6				

EMC: Emissions

Phenomenon	Standard	Test Level	Notes & Conditions
Conducted	EN55032	Level A	With no external components
Radiated	EN55032	Level A	See application notes

EMC: Immunity

Phenomenon	Standard	Test Level	Criteria	Notes & Conditions
Immunity	EN55024			
ESD Immunity	EN61000-4-2	±4 kV Contact, ±8 kV Air	A	
Radiated Immunity	EN61000-4-3	10 V/m	A	
EFT/Burst	EN61000-4-4	3	A	
Surges	EN61000-4-5	3	A	
Conducted Immunity	EN61000-4-6	10 Vm	A	
Magnetic Fields	EN61000-4-8	30 A/m	A	

Safety Approvals

Safety Agency	Safety Standard	Notes & Conditions
CB	IEC60950-1, IEC62368-1	ITE
UL	UL/cUL60950-1, UL/cUL62368-1	ITE
CE	Meets all applicable directives	
UKCA	Meets all applicable legislation	

Application Notes

Derating Curve for Convection Cooling

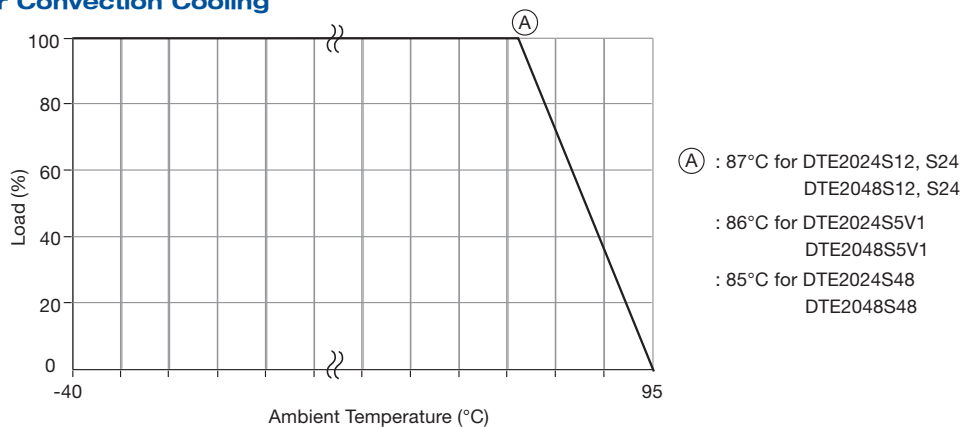

Radiated Emissions

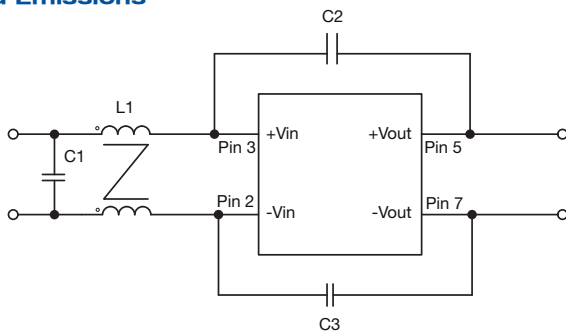

Model	L1	C1	C2	C3
DTE2024SXX	120 μ H	4.7 μ F/50 V	None	220 pF/3 KV
DTE2048SXX	120 μ H	3.3 μ F/100 V	220 pF/3 KV	220 pF/3 KV

Mechanical Details

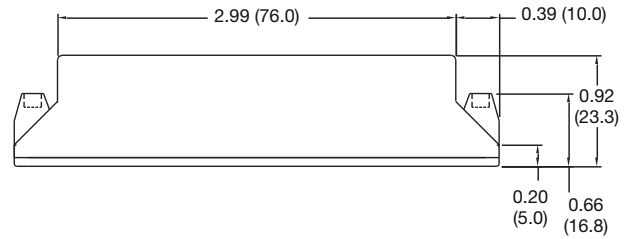
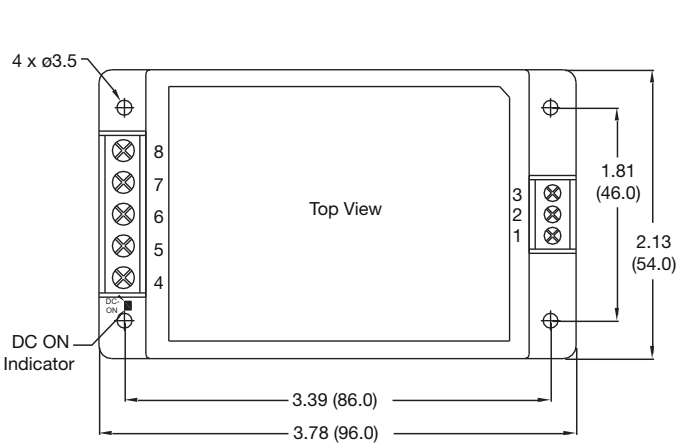

-D Version

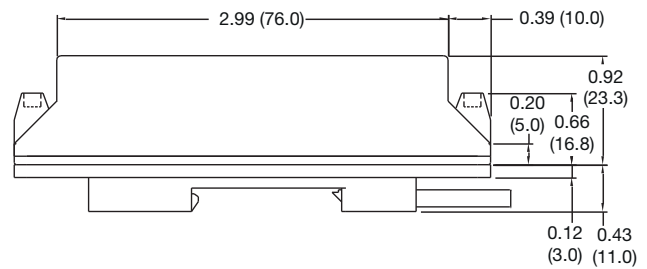

Notes

1. All dimensions are in inches (mm)
2. Weight: 0.214 lbs (107 g) approx
3. Weight for -D version: 0.332 lbs (166 g) approx
4. Terminal wire size 1.5 mm² max
5. Screw terminal torque 4.5 to 6.2 lb-in (0.5 to 0.7 Nm)
6. Case tolerance: ±0.02 (±0.5)

Pin Connections	
Pin	Function
1	Remote On/Off
2	-Vin
3	+Vin
4	No Connection
5	-Vout
6	No Connection
7	+Vout
8	No Connection