



RoHS compatibility information:  
<http://panasonic-denko.co.jp/ac/e/service/environment/index.jsp>

## FEATURES

- 1. Compact with high contact rating**  
 Even with small 10 mm .394 inch (H) x 11 mm .433 inch (W) x 20 mm .787 inch (L) (dimensions, high capacity switching is provided: 1a, 8 A 250 V AC; 2a and 1a1b, 5 A 250 V AC).
- 2. High switching capability**  
 High contact pressure, low contact bounce, and wiping operation improve resistance to weld bonding. Resistant against lamp load and dielectric loading: 1a achieves maximum switching capacity of 2,000 VA (8A 250 V AC).

### 3. High sensitivity

Using the same type of high-performance polar magnetic circuits as DS relays, by matching the spring load to the magnetic force of attraction, greater sensitivity has been achieved. The resultant pick up sensitivity of about 190 mW makes possible direct driving of transistors and chips.

### 4. High breakdown voltage

Breakdown voltage has been raised by keeping the coil and contacts separate.

| Between contact and coil                                    | Between contacts  |
|---|---|
| 3,000 Vrms for 1 min.<br>5,000 V surge<br>breakdown voltage | 1,000 Vrms for 1 min.<br>1,500 V surge<br>breakdown voltage |

Conforms with FCC Part 68

### 5. Latching types available

### 6. Wide variation

Three types of contact arrangement are offered: 1a, 2a, and 1a1b. In addition, each is available in standard and reversed polarity types.

### 7. Sealed construction allows automatic washing.

### 8. Complies with safety standards

Complies with Japan Electrical Appliance and Material Safety Law requirements for operating 200 V power supply circuits, and complies with UL, CSA, and TÜV safety standards.

## TYPICAL APPLICATIONS

1. Office and industrial electronic devices
2. Terminal devices of information processing equipment, such as printer, data recorder.
3. Office equipment (copier, facsimile)
4. Measuring instruments
5. NC machines, temperature controllers and programmable logic controllers.

### About Cd-free contacts

We have introduced Cadmium free type products to reduce Environmental Hazardous Substances.

(The suffix "F" should be added to the part number)

(Note: The Suffix "F" is required only for 1 Form A 1 Form B contact type.

The 1 Form A and 2 Form A contact type is originally Cadmium free, the suffix "F" is not required.)

Please replace parts containing Cadmium with Cadmium-free products and evaluate them with your actual application before use because the life of a relay depends on the contact material and load.

## ORDERING INFORMATION

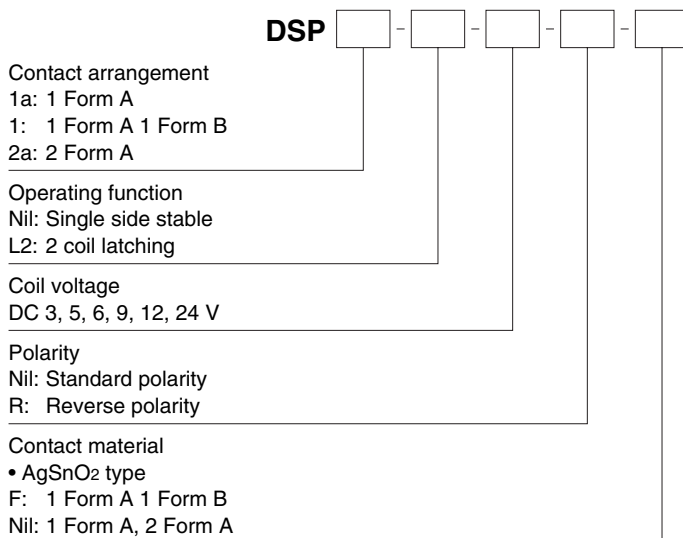

Notes: 1. Reverse polarity types available (add suffix-R)  
 2. UL/CSA, TÜV approved type is standard.

## TYPES

| Contact arrangement  | Nominal coil voltage | Single side stable | 2 coil latching |
|----------------------|----------------------|--------------------|-----------------|
|                      |                      | Part No.           | Part No.        |
| 1 Form A             | 3V DC                | DSP1a-DC3V         | DSP1a-L2-DC3V   |
|                      | 5V DC                | DSP1a-DC5V         | DSP1a-L2-DC5V   |
|                      | 6V DC                | DSP1a-DC6V         | DSP1a-L2-DC6V   |
|                      | 9V DC                | DSP1a-DC9V         | DSP1a-L2-DC9V   |
|                      | 12V DC               | DSP1a-DC12V        | DSP1a-L2-DC12V  |
|                      | 24V DC               | DSP1a-DC24V        | DSP1a-L2-DC24V  |
| 1 Form A<br>1 Form B | 3V DC                | DSP1-DC3V-F        | DSP1-L2-DC3V-F  |
|                      | 5V DC                | DSP1-DC5V-F        | DSP1-L2-DC5V-F  |
|                      | 6V DC                | DSP1-DC6V-F        | DSP1-L2-DC6V-F  |
|                      | 9V DC                | DSP1-DC9V-F        | DSP1-L2-DC9V-F  |
|                      | 12V DC               | DSP1-DC12V-F       | DSP1-L2-DC12V-F |
|                      | 24V DC               | DSP1-DC24V-F       | DSP1-L2-DC24V-F |
| 2 Form A             | 3V DC                | DSP2a-DC3V         | DSP2a-L2-DC3V   |
|                      | 5V DC                | DSP2a-DC5V         | DSP2a-L2-DC5V   |
|                      | 6V DC                | DSP2a-DC6V         | DSP2a-L2-DC6V   |
|                      | 9V DC                | DSP2a-DC9V         | DSP2a-L2-DC9V   |
|                      | 12V DC               | DSP2a-DC12V        | DSP2a-L2-DC12V  |
|                      | 24V DC               | DSP2a-DC24V        | DSP2a-L2-DC24V  |

Standard packing: Tube: 50 pcs.; Case: 500 pcs.

Note: Reverse polarity type are manufactured by lot upon receipt of order. Self-clinching types are also available, please consult us.

## RATING

### 1. Coil data

#### 1) Single side stable

| Nominal coil voltage | Pick-up voltage (at 20°C 68°F)            | Drop-out voltage (at 20°C 68°F)           | Nominal operating current [±10%] (at 20°C 68°F) | Coil resistance [±10%] (at 20°C 68°F) | Nominal operating power | Max. allowable voltage (at 20°C 68°F) |
|----------------------|---|---|---|---------------------------------------|-------------------------|---------------------------------------|
| 3V DC                | 80%V or less of nominal voltage (Initial) | 10%V or more of nominal voltage (Initial) | 100mA   | 30Ω                                   | 300mW                   | 130%V of nominal voltage              |
| 5V DC                |   |   | 60mA  | 83Ω                                   |                         |                                       |
| 6V DC                |   |   | 50mA  | 120Ω                                  |                         |                                       |
| 9V DC                |   |   | 33.3mA  | 270Ω                                  |                         |                                       |
| 12V DC               |   |   | 25mA  | 480Ω                                  |                         |                                       |
| 24V DC               |   |   | 12.5mA  | 1,920Ω                                |                         |                                       |

#### 2) 2 coil latching

| Nominal coil voltage | Set voltage (at 20°C 68°F)                | Reset voltage (at 20°C 68°F)              | Nominal operating current [±10%] (at 20°C 68°F) |            | Coil resistance [±10%] (at 20°C 68°F) |            | Nominal operating power |            | Max. allowable voltage (at 20°C 68°F) |
|----------------------|---|---|---|------------|---------------------------------------|------------|-------------------------|------------|---------------------------------------|
|                      |   |   | Set coil  | Reset coil | Set coil                              | Reset coil | Set coil                | Reset coil |                                       |
| 3V DC                | 80%V or less of nominal voltage (Initial) | 80%V or less of nominal voltage (Initial) | 100mA   | 100mA      | 30Ω                                   | 30Ω        | 300mW                   | 300mW      | 130%V of nominal voltage              |
| 5V DC                |   |   | 60mA  | 60mA       | 83Ω                                   | 83Ω        |                         |            |                                       |
| 6V DC                |   |   | 50mA  | 50mA       | 120Ω                                  | 120Ω       |                         |            |                                       |
| 9V DC                |   |   | 33.3mA  | 33.3mA     | 270Ω                                  | 270Ω       |                         |            |                                       |
| 12V DC               |   |   | 25mA  | 25mA       | 480Ω                                  | 480Ω       |                         |            |                                       |
| 24V DC               |   |   | 12.5mA  | 12.5mA     | 1,920Ω                                | 1,920Ω     |                         |            |                                       |

# DS-P

## 2. Specifications

| Characteristics                          | Item  | Specifications   |  |   |           |
|--|---|--|--|---|-----------|
|  |   | 1 Form A   | 1 Form A 1 Form B  | 2 Form A  |           |
| Contact                                  | Arrangement   | 1 Form A      1 Form A 1 Form B      2 Form A  |  |   |           |
|  | Initial contact resistance, max.  | Max. 30 mΩ (By voltage drop 6 V DC 1A)   |  |   |           |
| Rating                                   | Contact material  | Au-flashed AgSnO <sub>2</sub> type   |  |   |           |
|  | Nominal switching capacity (resistive load)   | 8 A 250 V AC, 5 A 30V DC   | 5 A 250 V AC, 5 A 30 V DC  |   |           |
|  | Max. switching power (resistive load)   | 2,000 VA, 150 W  | 1,250 VA, 150 W  |   |           |
|  | Max. switching voltage  | 380 V AC, 125 V DC   |  |   |           |
|  | Max. switching current  | 8 A AC, 5 A DC   | 5 A AC, DC   |   |           |
|  | Nominal operating power   | 300 mW   |  |   |           |
|  | Min. switching capacity (Reference value)*1   | 10m A 5 V DC   |  |   |           |
| Electrical characteristics               | Insulation resistance (Initial)   | Min. 1,000MΩ (at 500V DC)<br>Measurement at same location as "Initial breakdown voltage" section.          |  |   |           |
|  | Breakdown voltage (Initial)   | Between open contacts  | 1,000 Vrms for 1min. (Detection current: 10mA.)  |   |           |
|  |   | Between contact sets   | 2,000 Vrms (1 Form A 1 Form B, 2 Form A) (Detection current: 10mA.)                      |   |           |
|  |   | Between contact and coil   | 3,000 Vrms for 1min. (Detection current: 10mA.)  |   |           |
|  | Surge breakdown voltage*2   | between contacts and coil  | 5,000 V  |   |           |
|  | Temperature rise (at 65°C 149°F)  |  | Max. 55°C  | Max. 40°C   | Max. 55°C |
|  | Operate time [Set time] (at 20°C 68°F)  |  | Max. 10 ms [10 ms] (Nominal voltage applied to the coil, excluding contact bounce time.) |   |           |
| Release time [Reset time] (at 20°C 68°F) |   | Max. 5 ms [10 ms] (Nominal voltage applied to the coil, excluding contact bounce time.)<br>(without diode) |  |   |           |
| Mechanical characteristics               | Shock resistance  | Functional   | Min. 196 m/s <sup>2</sup> (Half-wave pulse of sine wave: 11 ms; detection time: 10μs.)   |   |           |
|  |   | Destructive  | Min. 980 m/s <sup>2</sup> (Half-wave pulse of sine wave: 6 ms.)                          |   |           |
|  | Vibration resistance  | Functional   | 10 to 55 Hz at double amplitude of 2 mm (Detection time: 10μs.)                          |   |           |
|  |   | Destructive  | 10 to 55 Hz at double amplitude of 3.5 mm  |   |           |
| Expected life                            | Mechanical  | Min. 5×10 <sup>7</sup> (at 180 cpm)  |  |   |           |
|  | Electrical  | Min. 10 <sup>5</sup> (resistive load)  |  |   |           |
| Conditions                               | Conditions for operation, transport and storage*3<br>(Not freezing and condensing at low temperature) | Ambient temperature:<br>-40°C to +60°C<br>-40°F to +140°F  | Ambient temperature:<br>-40°C to +65°C<br>-40°F to +149°F                                | Ambient temperature:<br>-40°C to +60°C<br>-40°F to +140°F |           |
|  | Solder heating  | 250°C 482°F (10s), 300°C 572°F (5s), 350°C 662°F (3s)<br>(Soldering depth: 2/3 terminal pitch)             |  |   |           |
|  | Max. operating speed  | 3 cps  |  |   |           |
| Unit weight                              |   | Approx. 4.5 g .16 oz   |  |   |           |

Notes: \*1 This value can change due to the switching frequency, environmental conditions, and desired reliability level, therefore it is recommended to check this with the actual load.

\*2 Wave is standard shock voltage of ±1.2×50μs according to JEC-212-1981

\*3 Refer to 6. Conditions for operation, transport and storage mentioned in AMBIENT ENVIRONMENT.

## REFERENCE DATA

1. Max. switching capacity

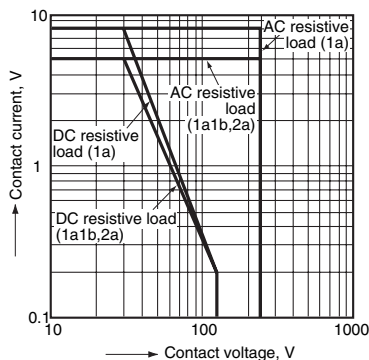

2.-(1) Life curve (1 Form A 1 Form B)

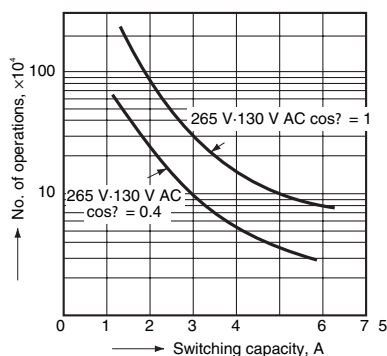

2.-(2) Life curve (1 Form A 1 Form B)

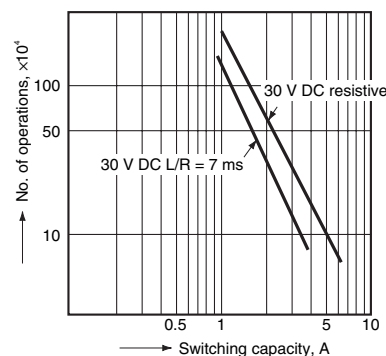

3.-(1) Coil temperature rise (1 Form A)

Tested sample: DSP1a-DC12V, 5 pcs.

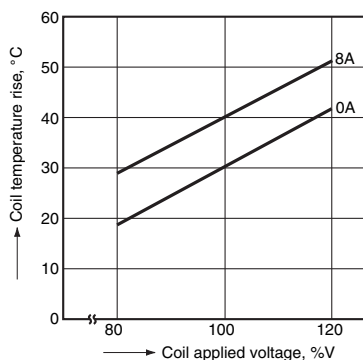

3.-(2) Coil temperature rise (1 Form A 1 Form B)

Tested sample: DSP1-DC12V, 5 pcs.

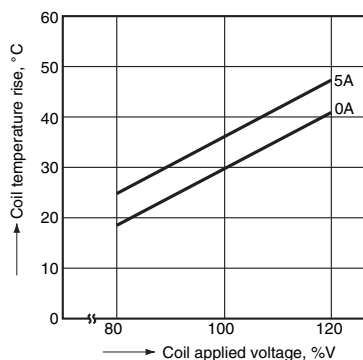

3.-(3) Coil temperature rise (2 Form A)

Tested sample: DSP2a-DC12V, 5 pcs.

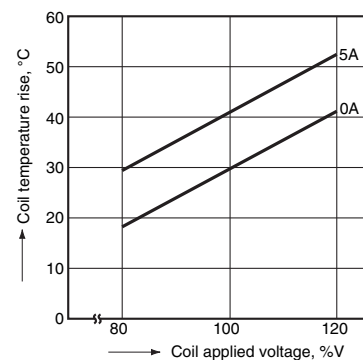

4.-(1) Operate & release time

(without diode, 1 Form A)

Tested sample: DSP1a-DC12V, 5 pcs.

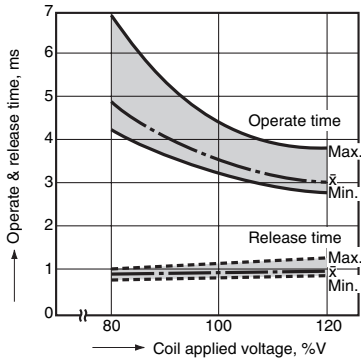

4.-(2) Operate & release time

(without diode, 1 Form A 1 Form B)

Tested sample: DSP1-DC12V, 5 pcs.

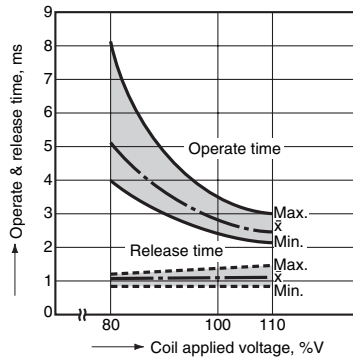

4.-(3) Operate & release time

(without diode, 2 Form A)

Tested sample: DSP2a-DC12V, 5 pcs.

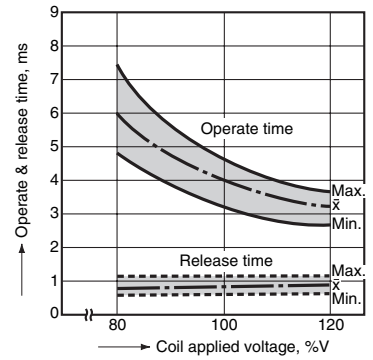

4.-(4) Operate & release time

(with diode, 1 Form A)

Tested sample: DSP1a-DC12V, 5 pcs.

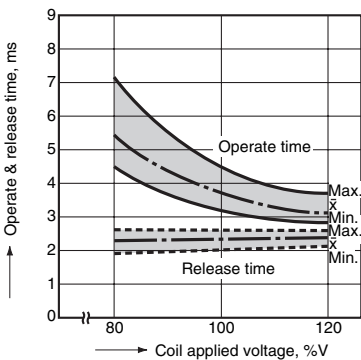

4.-(5) Operate & release time

(with diode, 1 Form A 1 Form B)

Tested sample: DSP1-DC12V, 5 pcs.

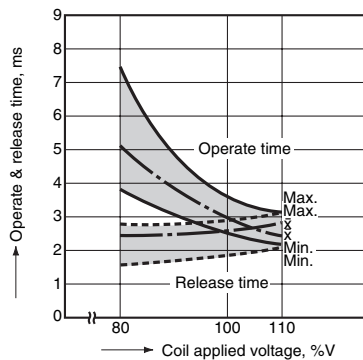

4.-(6) Operate & release time

(with diode, 2 Form A)

Tested sample: DSP2a-DC12V, 5 pcs.

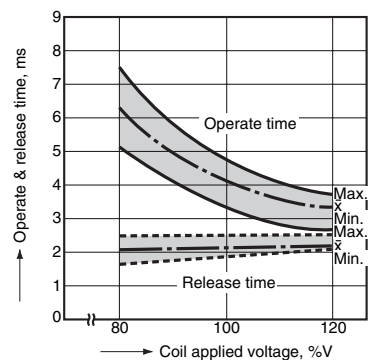

5.-(1) Change of pick-up and drop-out voltage

(1 Form A)

Tested sample: DSP1a-DC12V, 5 pcs.

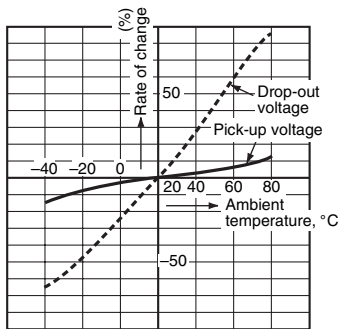

5.-(2) Change of pick-up and drop-out voltage

(1 Form A 1 Form B)

Tested sample: DSP1-DC12V, 5 pcs.

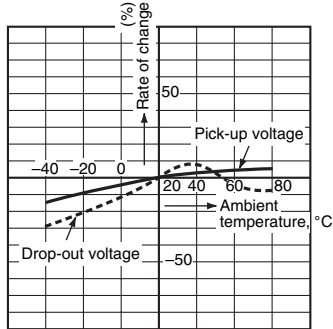

5.-(3) Change of pick-up and drop-out voltage

(2 Form A)

Tested sample: DSP2a-DC12V, 5 pcs.

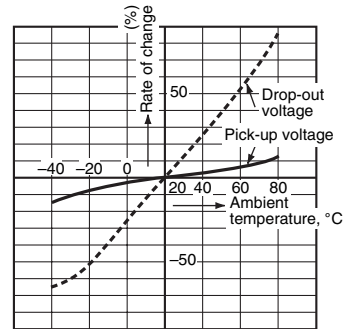

6.-(1) Influence of adjacent mounting

(1 Form A)

Tested sample: DSP1a-DC12V, 5 pcs.

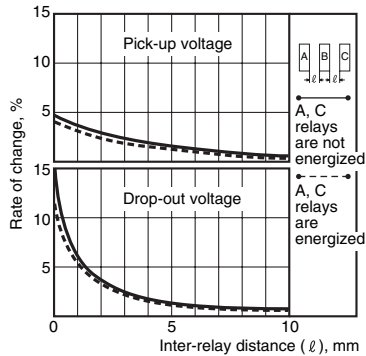

6.-(2) Influence of adjacent mounting

(1 Form A 1 Form B)

Tested sample: DSP1-DC12V, 5 pcs.

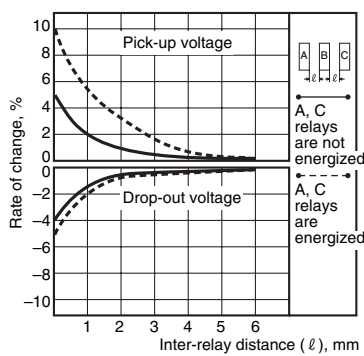

6.-(3) Influence of adjacent mounting

(2 Form A)

Tested sample: DSP2a-DC12V, 5 pcs.

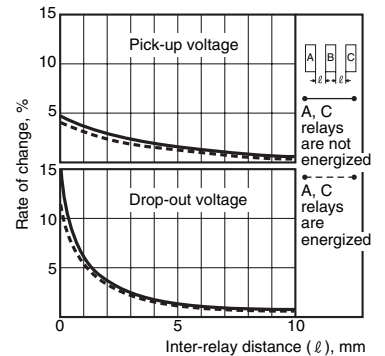

# DS-P

## DIMENSIONS (Unit: mm inch)

### 1. 1 Form A type

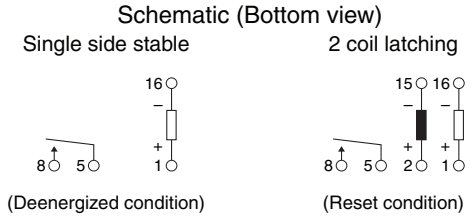
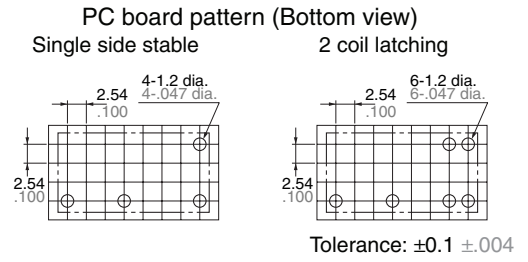
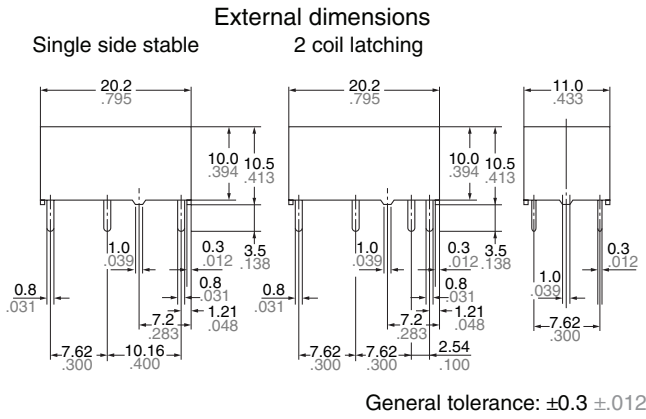

### 2. 1 Form A 1 Form B type

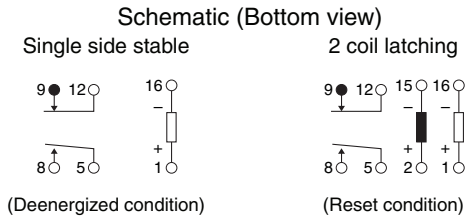
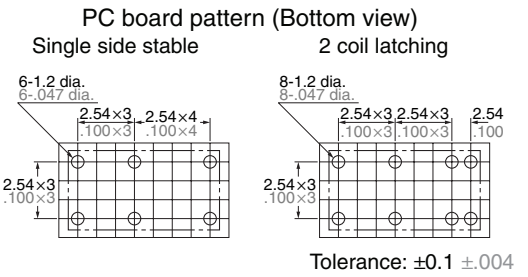
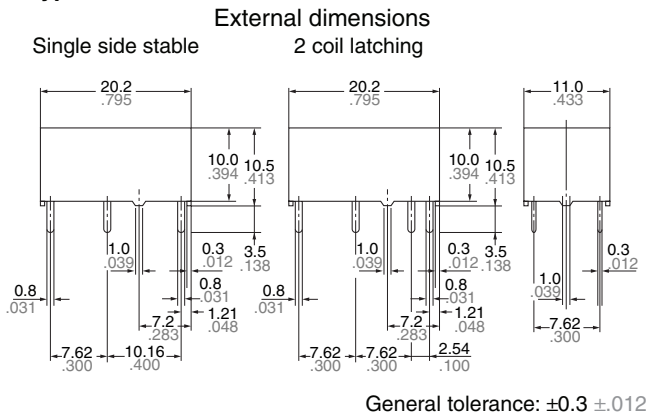

### 3. 2 Form A type

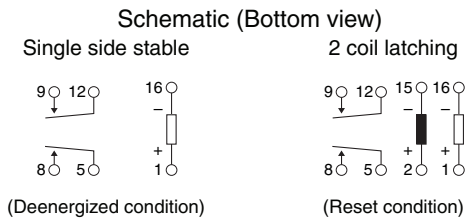
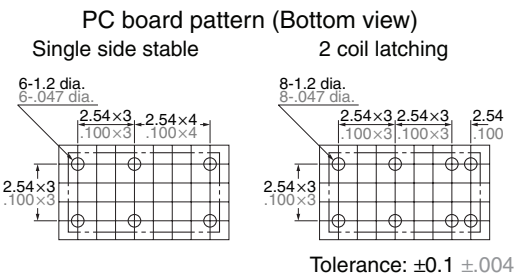
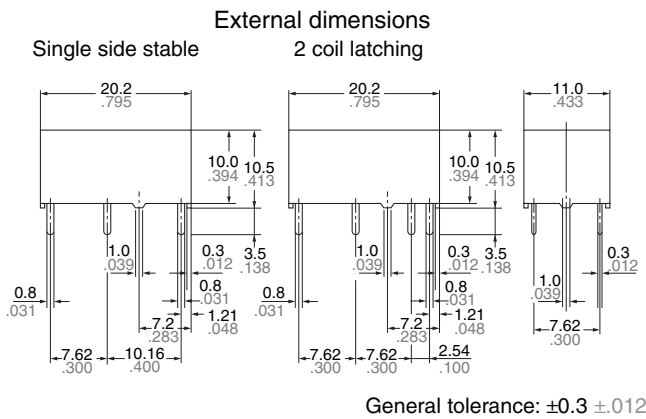

---

## NOTES

### 1. Soldering should be done under the following conditions:

250°C 482°F within 10 s

300°C 572°F within 5 s

350°C 662°F within 3 s

### 2. Cleaning

For automatic cleaning, the boiling method is recommended. Avoid ultrasonic cleaning which subjects the relays to high frequency vibrations, which may cause the contacts to stick.

It is recommended that a fluorinated hydrocarbon or other alcoholic solvents be used.

### 3. External magnetic field

Since DY relays are highly sensitive polarized relays, their characteristics will be affected by a strong external magnetic field. Avoid using the relay under that condition.

### 4. Coil operating power

Pure DC current should be applied to the coil. The wave form should be rectangular. If it includes ripple, the ripple factor should be less than 5%.

However, check it with the actual circuit since the characteristics may be slightly different.

5. When using, please be aware that the a contact and b contact sides of 1 Form A and 1 Form B types may go on simultaneously at operate time and release time.

---

**For Cautions for Use, see Relay Technical Information**

**TYPES AND APPLICABLE RELAYS**

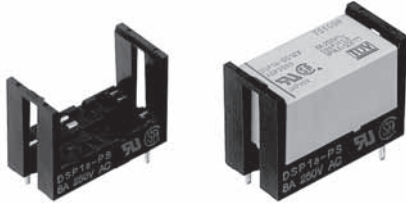

| Applicable relays | Type No. | For DSP1a |            | For DSP1a, DSP1, DSP2a |            |
|-------------------|----------|-----------|------------|------------------------|------------|
|                   |          | DSP1a-PS  | DSP1a-PSL2 | DSP2a-PS               | DSP2a-PSL2 |
| DSP1a relays      |          | OK        | OK         | OK                     | OK         |
| DSP1a-L2 relays   |          |           | OK         |                        | OK         |
| DSP1 relays       |          |           |            | OK                     | OK         |
| DSP1-L2 relays    |          |           |            |                        | OK         |
| DSP2a relays      |          |           |            | OK                     | OK         |
| DSP2a-L2 relays   |          |           |            |                        | OK         |

**SPECIFICATIONS**

| Item                    | Specifications  |
|-------------------------|---|
| Breakdown voltage       | 3,000 Vrms between terminals<br>(Except for the portion between coil terminals) |
| Insulation resistance   | 1,000 MΩ between terminals at 500 V   |
| Heat resistance         | 150°C for 1 hour  |
| Max. continuous current | 8 A   |

RoHS Directive compatibility information  
<http://www.mew.co.jp/ac/e/environment/>

**DIMENSIONS** (Unit: mm inch)

External dimensions

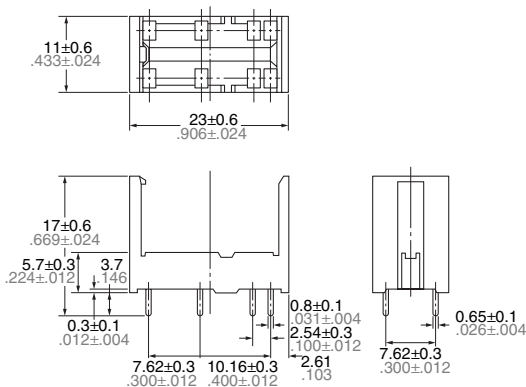

PC board pattern (Bottom view)

DSP1a-PS, DSP1a-PSL2

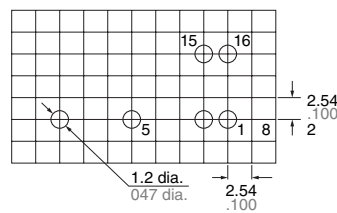

Terminal No.2 and 15 are for DSP1a-PSL2 only.

DSP2a-PS, DSP2a-PSL2

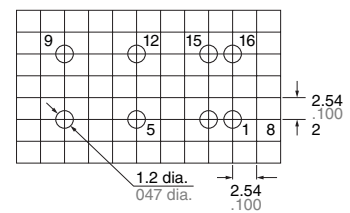

Terminal No.2 and 15 are for DSP2a-PSL2 only.

**FIXING AND REMOVAL METHOD**

1. Match the direction of relay and socket.

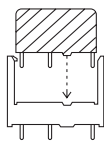

2. Both ends of relays are fixed so tightly that the socket hooks on the top surface of relays.

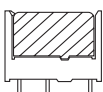

Good

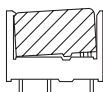

No good

3. Remove the relay, applying force in the direction shown below.

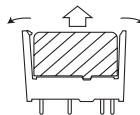

4. In case there is not enough space for finger to pick relay up, use screw drivers in the way shown below.

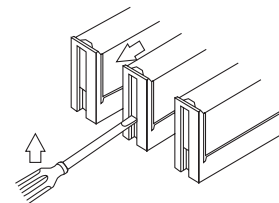

Notes: 1. Exercise care when removing relays. If greater than necessary force is applied at the socket hooks, deformation may alter the dimensions so that the hook will no longer catch, and other damage may also occur.  
2. It is hazardous to use IC chip sockets.