

REV  
B **DRBF-3\*\***

REVISIONS			
SYM	DESCRIPTION	DATE	APPROVED
NC	NEW RELEASE PER E.O. P17210	4-9-01	R.D.R.
A	REVISED PER E.O. P18954	7-12-05	R.D.R.
B	REVISED PER E.O. P19034	9-13-05	RDR

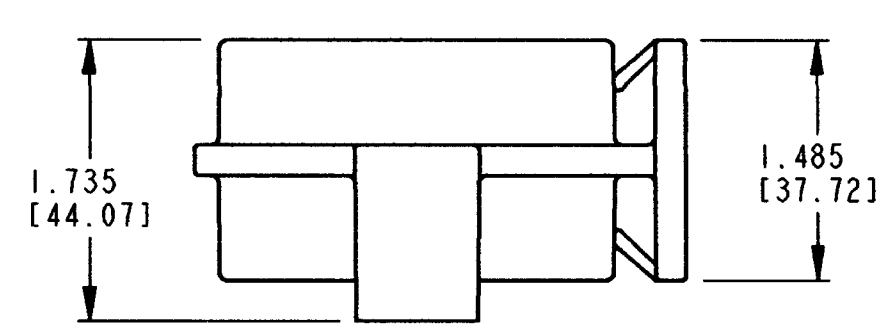
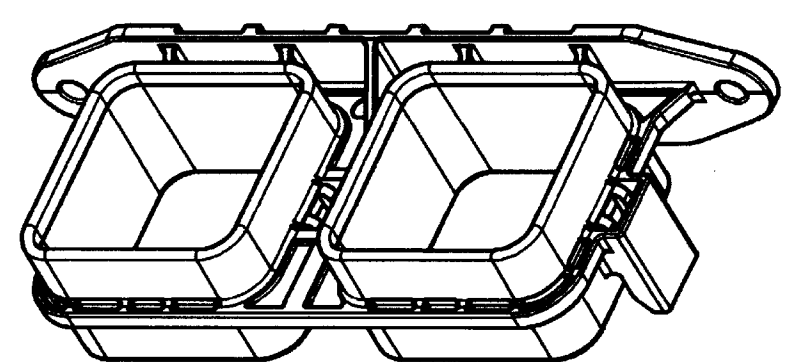

- NOTES:
1. DIMENSIONS ARE IN INCHES [mm].
  2. DIMENSION TOLERANCE: ±.025 [.64].
  3. THIS PART MATES WITH DRB12-48P\*(N)E-\*\*\*\*, DRB12-60P\*(N)E-\*\*\*\*, DRB16-48S\*(N)E-\*\*\*\*, AND DRB16-60S\*(N)E-\*\*\*\*. (\* = A,B,C,D KEYS; \*\*\*\* = ALL MODIFICATIONS). CONSULT FACTORY FOR MODS.
  4. MATERIAL: PLASTIC
  5. SEE SHEETS 2, 3 AND 4 FOR OTHER KEY ARRANGEMENTS.

SIGNATURE & DATE	
DR	S.PALLUTH 04/04/01
CHK	R. Milligan 9-13-05
PE	W. Adams 9/13/05
APPD	D. Meyer 9/13/05
SCALE	NONE 1:1

FLANGE DUAL INTERFACE  
KEYS: AA THRU DD  
COLOR: BLACK  
DRB SERIES

ENVELOPE

CP	EP063	MATL CODE
<b>The Deutch Company</b> DEUTSCH I.P.D. 3850 INDUSTRIAL AVE. HEMET, CALIF. 92545		
<b>B</b>	<b>DRBF-3**</b>	
DWG SIZE	CODE 11139	SHEET 1 OF 4

REV B DRBF-3\*\*

REVISIONS			
SYM	DESCRIPTION	DATE	APPROVED
B	SEE SHEET 1	9-13-05	RDR

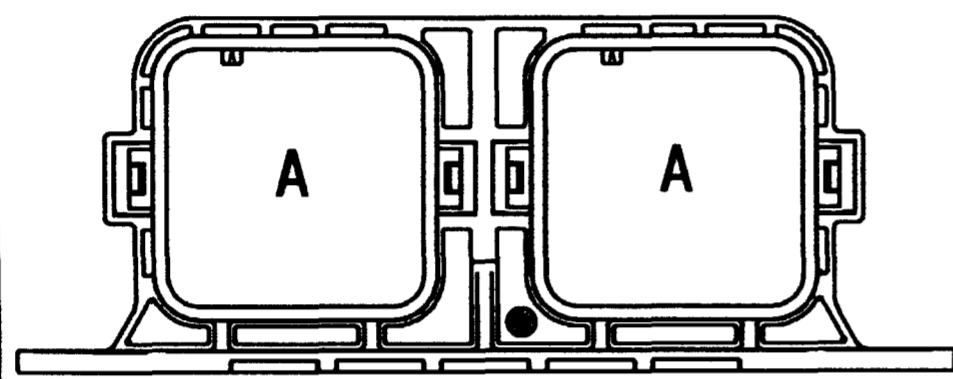

DRBF-3AA  
KEYS A & A

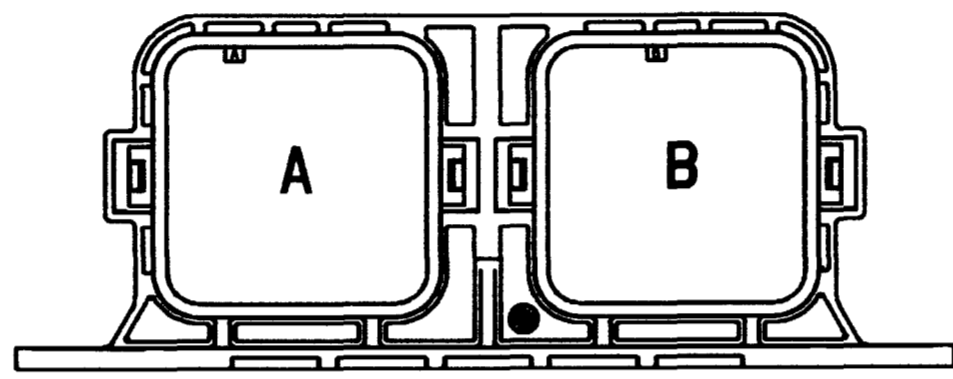

DRBF-3AB  
KEYS A & B

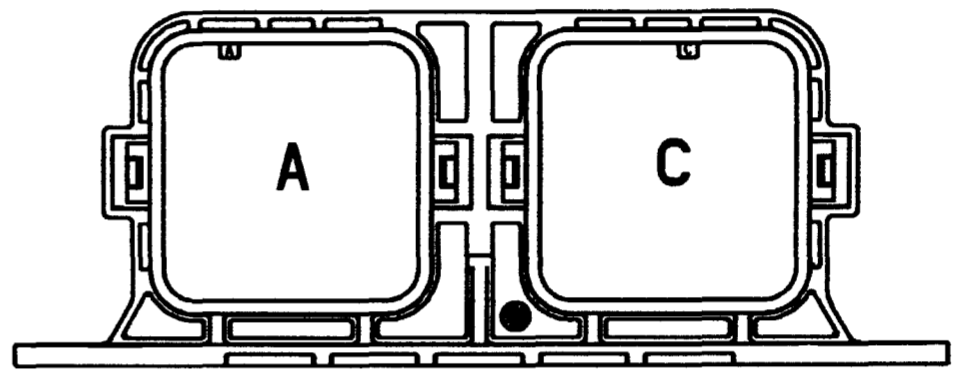

DRBF-3AC  
KEYS A & C

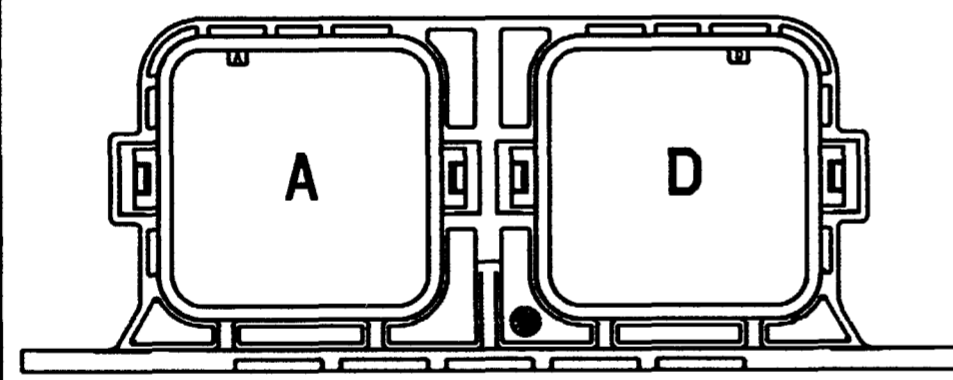

DRBF-3AD  
KEYS A & D

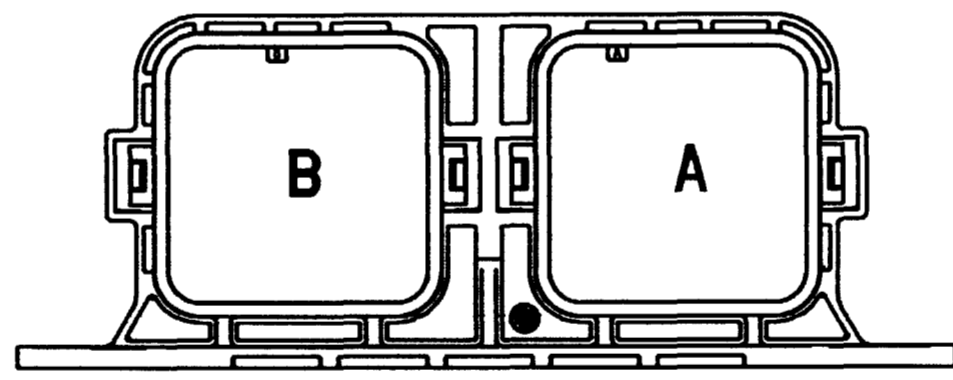

DRBF-3BA  
KEYS B & A

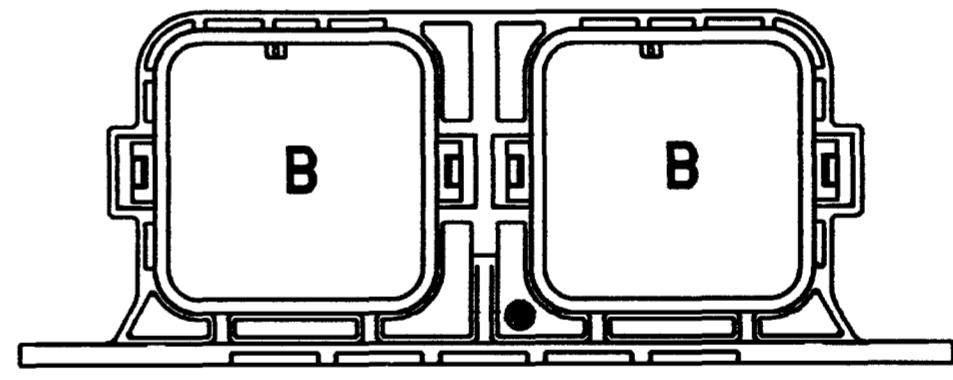

DRBF-3BB  
KEYS B & B

NOTES:

SIGNATURE & DATE	
DR	S. PALLUTH 04/04/01
CHK	R. Sullivan 9-13-05
PE	Vladimir Tomasev SEP-2-05
APPD	D. Meyer 9/16/05
SCALE	NONE DWT

FLANGE DUAL INTERFACE  
KEYS: AA THRU DD  
COLOR: BLACK  
DRB SERIES  
  
ENVELOPE

CP	EP063	MATL. CODE
<b>The Deutsch Company</b> DEUTSCH I.P.D. 3850 INDUSTRIAL AVE. HEMET, CALIF. 92545		
<b>B</b>	<b>DRBF-3**</b>	
DWG. SIZE	CODE 11139	SHEET 2 OF 4

REV  
B DRBF-3\*\*

REVISIONS			
SYM	DESCRIPTION	DATE	APPROVED
B	SEE SHEET 1	9-13-05	RDR

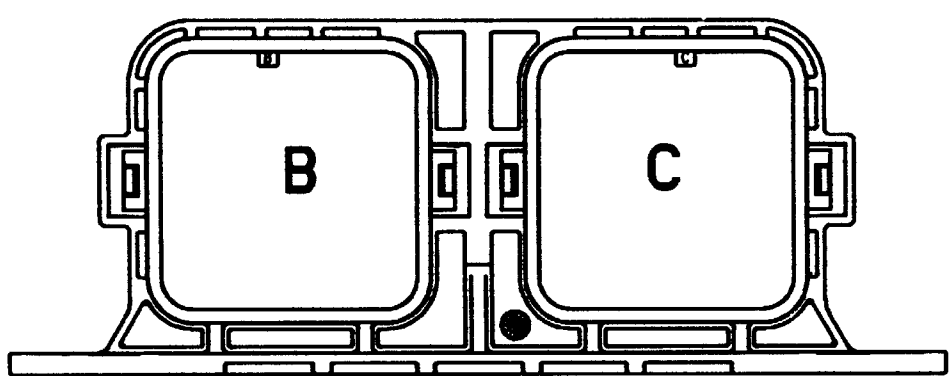

DRBF-3BC  
KEYS B & C

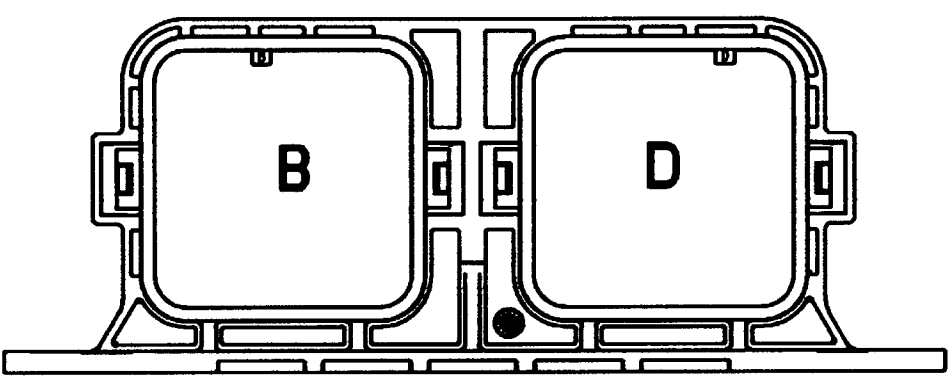

DRBF-3BD  
KEYS B & D

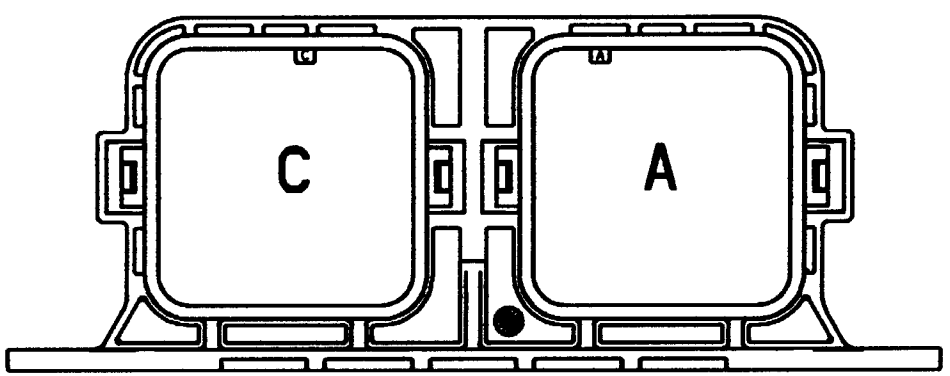

DRBF-3CA  
KEYS C & A

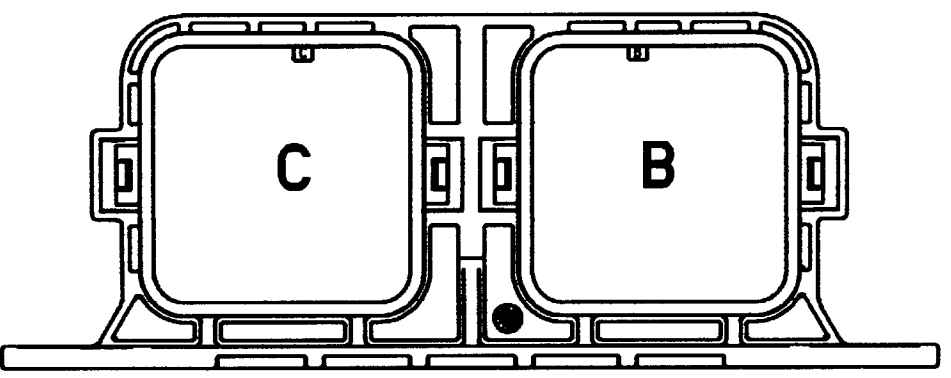

DRBF-3CB  
KEYS C & B

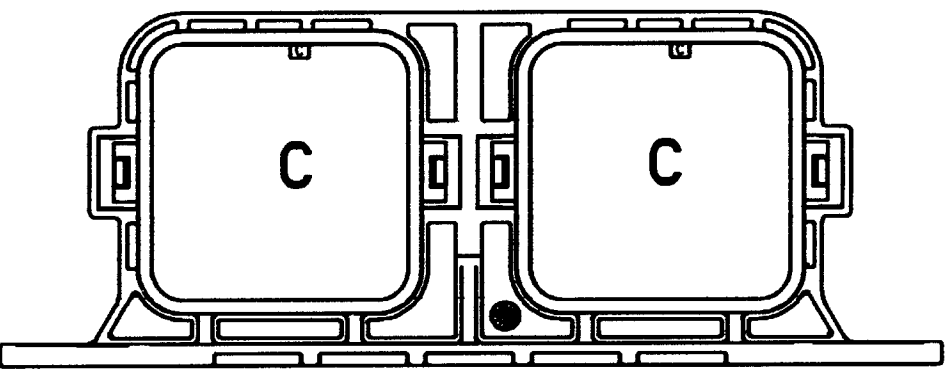

DRBF-3CC  
KEYS C & C

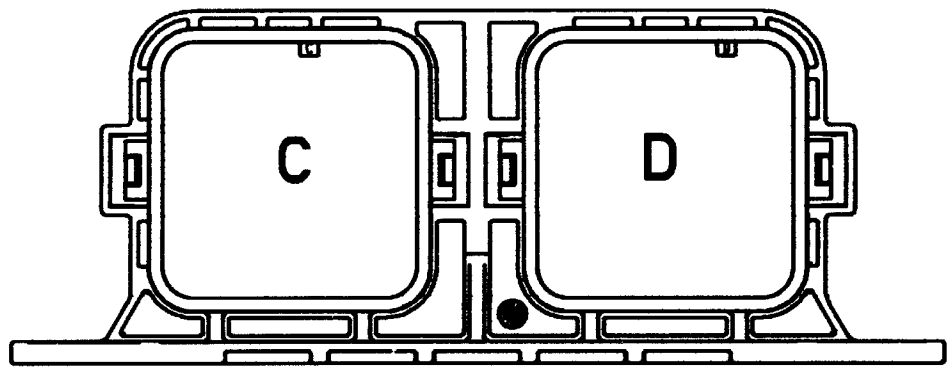

DRBF-3CD  
KEYS C & D

NOTES:

SIGNATURE & DATE	
DR	S. PALLUTH 04/04/01
CHK	<i>R. Miller</i> 9-13-05
PE	<i>Radwin Tomse</i> SEP-2-05
APPD	<i>D. Messy</i> 9/16/05
SCALE	NONE

FLANGE DUAL INTERFACE  
KEYS: AA THRU DD  
COLOR: BLACK  
DRB SERIES  
  
ENVELOPE

CP	EP063	MATL. CODE
<b>The Deutsch Company</b> DEUTSCH I. P. D. 3850 INDUSTRIAL AVE. HEMET, CALIF. 92545		
<b>B</b>	<b>DRBF-3**</b>	
DWG SIZE	CODE 11139	SHEET 3 OF 4

REV B	DRBF-3**	REVISIONS		
SYM	DESCRIPTION	DATE	APPROVED	
B	SEE SHEET 1	9-13-05	RDR	

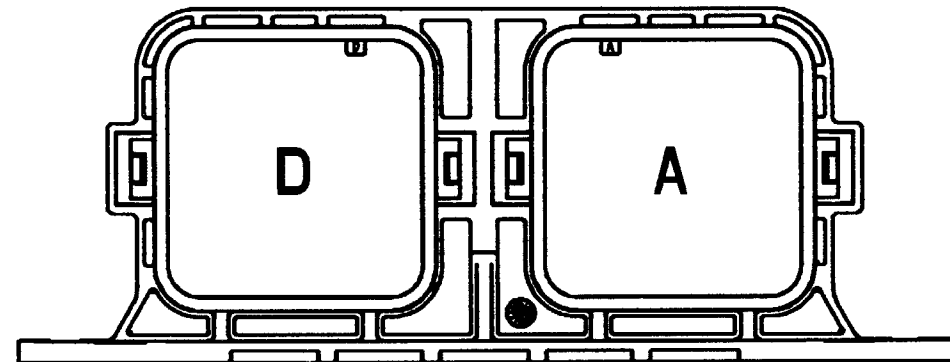

DRBF-3DA  
KEYS D & A

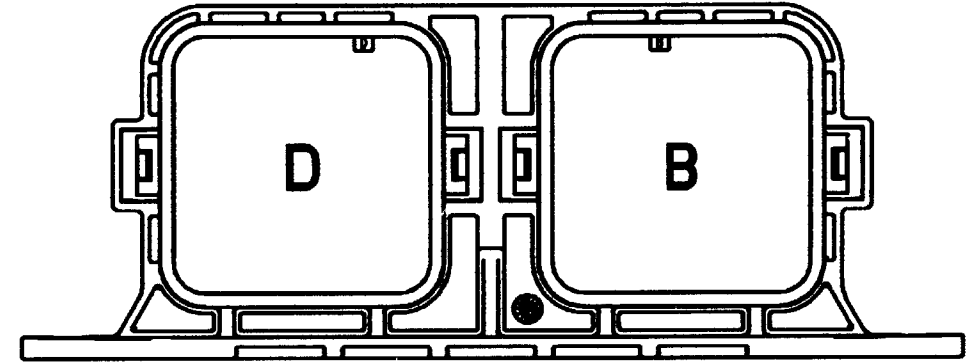

DRBF-3DB  
KEYS D & B

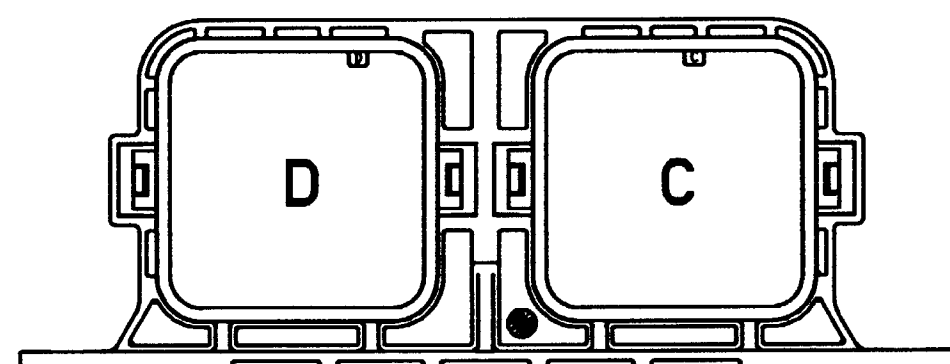

DRBF-3DC  
KEYS D & C

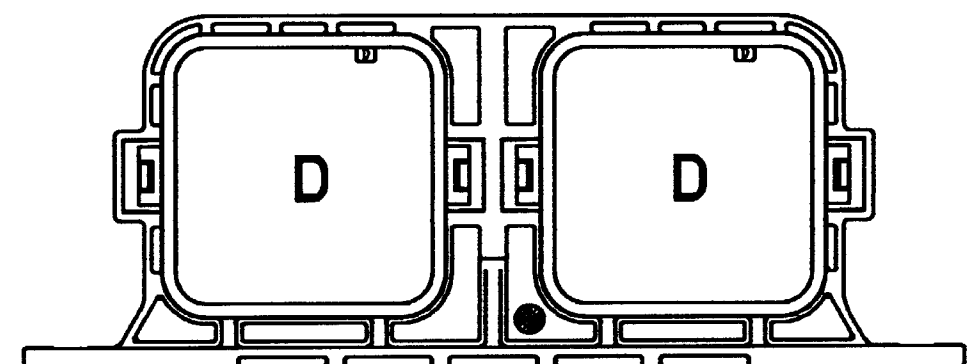

DRBF-3DD  
KEYS D & D

NOTES:

SIGNATURE & DATE		FLANGE DUAL INTERFACE KEYS: AA THRU DD COLOR: BLACK DRB SERIES	CP	EP063	MATL. CODE
DR	S. PALLUTH 04/04/01		The Deutch Company		
CHK	R. Sullivan 9-13-05		DEUTSCH I.P.D. 3850 INDUSTRIAL AVE. HEMET, CALIF. 92545		
PE	Nadimir Tomor SEP 2005				
APPD	D. May 9/6/05		B DRBF-3**		
SCALE	NONE	ENVELOPE	DWG SIZE	11139	SHEET 4 OF 4