

Industries & Applications



Automation



Industrial



Semi-Fab



Renewable



Comms



Test

ePLAN[®]
data portal

Features & Benefits

- ▶ **Wide 3 phase input range** for global mains voltages
- ▶ **Power boost of 120% for 2s** to support capacitive loads start-up
- ▶ **Smart Hiccup behaviour in short-circuit situation** avoids self-heating
- ▶ **Parallel mode switch** to activate load balancing behaviour
- ▶ **Two means of transient protection** increase process stability
- ▶ **Fast OVP control** protects sensitive loads
- ▶ **Very low inrush energy peak (I^2t)** saves cost for input line protection
- ▶ **Screw or push-in terminals available** to serve individual connection needs
- ▶ **High efficiency and low stand-by losses contribute to an eco-friendly energy footprint**
- ▶ **Strong CC overload behaviour** secures process reliability under demanding load conditions
- ▶ **DC-OK and inhibit relay contacts** for professional integration into applications control architecture
- ▶ Designed to meet the 7 most accepted IEC safety standards
- ▶ Exceeds regulatory EMC standards on radiated emission (Class B), surge immunity and fast transients



Technical data abstract¹

Output voltage	<i>nom.</i>	24V _{DC}
Adjustment range	<i>max.</i>	22.5..29V _{DC}
Output current	<i>nom.</i>	10A
Output current boost	<i>max.</i>	12A / 2s
Overload behaviour		CC + Hiccup
Hold-up time ²	<i>min.</i>	22 / 44ms
Frequency range	<i>max.</i>	47 .. 63Hz
AC Input voltage	<i>nom.</i>	3x400V _{AC}
AC Input voltage range	<i>max.</i>	3x350 .. 575V _{AC}
Inrush current ²	<i>max.</i>	42 / 42A
Inrush energy ²	<i>max.</i>	0.3 / 0.8A ² s
Output power	<i>nom.</i>	240W
Output power boost	<i>max.</i>	288W / 2s
Power factor ²	<i>min.</i>	0.6
Conversion efficiency ²	<i>max.</i>	93.1 / 93.2%
Power consumption	<i>max.</i>	18W
Stand-by consumption ²	<i>max.</i>	1.6 / 2.0W
Ambient operating temperature	<i>max.</i>	-25 .. +70°C (-13 .. +158°F)
	<i>nom.</i>	-25 .. +55°C (-13 .. +131°F)
Service lifetime ²	<i>min.</i>	125 000 / 136 000hrs
Service life MTBF	<i>min.</i>	5.7M hrs
Width		55mm (2 ¹¹ / ₆₄ in)
Height		129mm (5 ⁵ / ₆₄ in)
Weight		780g (1.72lb)

¹ All values refer to STC unless otherwise stated

² 400 / 500V_{AC}

Certifications



IEC EN 61010-1
IEC EN 61010-2-201
IEC EN 62368-1 (Ed.2)



UL CSA 61010-1
UL CSA 61010-2-201
E356563



UL CSA 62368-1 (Ed.2)
E511889

Compliance & Registration



EU Low Voltage Dir. 2014/35/EU
EU EMC Dir. 2014/30/EU
EU RoHS Dir. 2011/65/EU



Safety and EMC Reg. 2016
Hazard. Substances Reg. 2012



Registration for Russia, Belarus,
Armenia, Kazakhstan and
Kyrgyzstan



China RoHS Law SJ/T 11363-2006







Commercial information

Order codes	DRB240-24-3-A0 DRB240-24-3-A1
HS code	8504408290
Life-cycle status	launch
Single packaging dimensions	
Width	70mm (2 ³ / ₄ in)
Height	180mm (7 ³ / ₃₂ in)
Depth	166mm (6 ¹⁷ / ₃₂ in)
Gross weight	900g (1.98lb)
Multiple packaging quantity	8 units
Manufacturer warranty	3 years

Model selector

Model name	Output Power	Output Voltage	Feature
DRB120-12-3-A0	120W	12V _{DC}	Screw terminals
DRB120-12-3-A1	120W	12V _{DC}	Push-in terminals
DRB120-24-3-A0	120W	24V _{DC}	Screw terminals
DRB120-24-3-A1	120W	24V _{DC}	Push-in terminals
DRB240-24-3-A0	240W	24V _{DC}	Screw terminals
DRB240-24-3-A1	240W	24V _{DC}	Push-in terminals
DRB240-48-3-A0	240W	48V _{DC}	Screw terminals
DRB240-48-3-A1	240W	48V _{DC}	Push-in terminals

Accessories

DBM20	20A buffer module for short-term hold-up or peak power in 24V _{DC} load systems.	
DRM40B	40A redundancy module for creating redundant power supply systems up to 2x 20A.	
DRM40	40A redundancy module with additional signaling features for creating redundant power supply systems up to 2x 20A.	
DDA250N	250W non-isolated step-down DC/DC converter for creating additional DC bus voltages from a single DC input source.	



Index

1.	General	5
2.	Electrical output	6
3.	Electrical input.....	7
4.	Performance	8
5.	Ambient conditions.....	9
6.	Reliability and service lifetime	10
7.	Dimensions & Mechanical data.....	11
8.	Installation clearances.....	12
9.	Wiring & Connection	12
10.	Signaling & Control.....	13
11.	Block diagram.....	14
12.	Device protection	14
13.	Electrical Safety.....	15
14.	Electromagnetic immunity	16
15.	Electromagnetic emission.....	16
16.	Certifications	17
17.	Additional safety standards	17
18.	Compliance & Registration	17
19.	Typical use-cases.....	18



List of abbreviations

avg.	<i>average</i>	The arithmetic average calculated from a row of values.
CC		Constant output current
chap.		Chapter
Dir.		Directive
eCap		Electrolytic capacitor
EMC		Electromagnetic Compatibility
Iac		AC input current under a particular operating condition
Iout		DC output current under a particular operating condition
Iout_boost		Max. DC output current (time limited) without a shortfall of Uset.
Iout_nom		Nominal DC output current
Iout_ol		Max. intermittent DC output current in an overload situation and a shortfall of Uset.
Iout_sc		Max. short circuit DC output current and Uout close to zero.
ITU		International Telecommunication Union
max.	<i>maximum</i>	The maximum value which a parameter can assume, or which must not be exceeded. As a precondition, none of the other technical parameters exceeds its max./min. value at the same time.
MCB		Miniature circuit breaker
min.	<i>minimum</i>	The minimum value which a parameter can assume, or must not be fallen below. As a precondition, none of the other technical parameters exceeds its max./min. value at the same time.
MTBF		Mean Time Between Failure
nom.	<i>nominal</i>	The ideal or reference value of a technical parameter which is guaranteed under STC. All nominal values in this document refer to each other and represent the general specification of the device.
OCP		Overcurrent protection
OTP		Overtemperature protection
OVP		Overvoltage protection
PELV		Protective Extra Low Voltage
Pout		Output power under a particular operating condition
Pout_boost		Max. output power (time limited) without a shortfall of Uset.
Pout_nom		Nominal output power
PSU		Power supply unit
Reg.		Regulation
SELV		Safety Extra Low Voltage
STC		Standard test conditions (see „1. General“ on page 5)
typ.	<i>typical</i>	The typical value of a parameter is not guaranteed but can be assumed under STC. The min. or max. value must be determined during the engineering process of the end application.
Uout		DC output voltage under a particular operating condition
Uout_nom		Nominal DC output voltage
Uset		Manually set output voltage via voltage potentiometer
UVP		Undervoltage protection
Vac		AC input voltage under a particular operating condition
Vac_nom		Nominal AC input voltage
/		Separator between two values. The conditions to which the values refer can be found in the last column of the table.
..		Specifies a range of values.

Table data structure

X. Technical category

Technical parameter	Characteristic (optional)	Values	Condition (optional)
---------------------	---------------------------	--------	----------------------

1. General

1.1 Handling of the product

To ensure faultless and safe operation of the products it is required to observe the specified ambient conditions for transport and storage (see "Ambient conditions" on page 9), set-up, assembly, installation, commissioning, operation and maintenance.

1.2 Protection enclosure required

The device must be installed in a protective housing or control cabinet to which only qualified personnel have access.

1.3 Humid environments

Do not operate the device in a damp environment or in an environment where condensation is likely to occur.

1.4 Switch/Circuit-breaker mounting position

A switch or circuit-breaker must be mounted near the equipment.

1.5 Observe country-specific regulations

In addition to the product documentation, the relevant country-specific regulations for the installation of the device must be observed.

1.6 Prohibited electrical/mechanical modifications

The product must not be modified in any way electrically or mechanically. Modifications can result in fatal injuries and damage to property.

1.7 Expiry of the manufacturer's warranty

The power supply is maintenance-free. Repairs can only be carried out by the manufacturer. Opening the housing voids the manufacturer's warranty.

1.8 Use of third-party products

If third-party products and components are used for power or voltage increase, buffering (AC or DC side), EMC filtering, redundancies or for DC side load protection, it must be in accordance with the TDK-Lambda product specification.

1.9 Standard test conditions

Unless otherwise stated, all values are specified in normal mounting position, at full load, nominal input and output voltages, 25°C (131°F) ambient temperature and a run-in time of 5 minutes.

1.10 Normal mounting position

In the normal mounting position, the front side of the product faces into the direction of the Y axis.

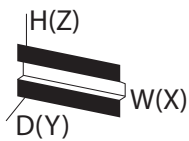
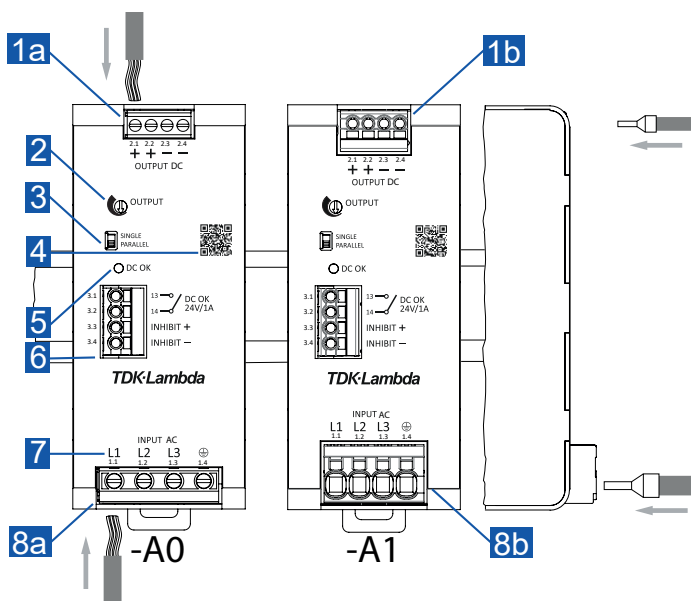

Fig. 1: Illustration of the spatial axis with reference to the DIN-Rail

1.11 Description of user elements



- 1a Screw terminal, DC output
- 1b Push-in terminal, DC output
- 2 Single turn potentiometer for adjusting the output voltage
- 3 Dip-switch for configuration as single or parallel operation. When changing the operating mode, the mains voltage must be disconnected.
- 4 Web link to further documentation
- 5 Green DC-OK status LED
- 6 Push-in terminal for signal contacts
- 7 Unique connection identifier usable for end-user wiring diagram
- 8a Screw terminal, AC input
- 8b Push-in terminal, AC input

i For more detailed information on the input/output wiring and the connection of the signalling contacts, please refer to "Wiring & Connection" on page 12.

Fig. 2: Description of user elements

Unless otherwise stated, all values are specified in normal mounting position, at full load, nominal input and output voltages, 25°C (77°F) ambient temperature and a run-in time of 5 minutes.

2. Electrical output

Output voltage [U_{out_nom}]	<i>nom.</i> 24V _{DC}	
Adjustment range [U_{set}]	<i>max.</i> 22.5..29V _{DC}	
Adjustment tolerance	<i>max.</i> ±3%	at upper/lower end position of voltage potentiometer
Factory default	24V _{DC}	
Output current [I_{out_nom}]	<i>nom.</i> 10A	
Boost current [I_{out_boost}]	<i>max.</i> 12A / 2s	
Overload behaviour	Constant current + Hiccup	see Fig. 4
Overload current	<i>max.</i> 15A	400..500V _{AC}
Intermittent OL current [I_{out_ol}]	<i>max.</i> 15A / 0.3s <i>avg.</i> 1.7A / 12s	400..500V _{AC} 400..500V _{AC}
Short-circuit proof	yes	
Instant SC current [I_{out_sc}]	<i>max.</i> 36A / < 1ms	400..500V _{AC}
Start-up delay	<i>max.</i> 1.8s	400..500V _{AC}
Rise time	<i>typ.</i> 8 / 7ms <i>typ.</i> 13 / 12ms	400 / 500V _{AC} , 0% P _{out} 400 / 500V _{AC} , 100% P _{out} , resistive load
Voltage overshoot	<i>typ.</i> 1.7V _{DC}	400..500V _{AC}
Fall time	<i>typ.</i> 13ms	400..500V _{AC}
Hold-up time	<i>min.</i> 22 / 44ms	400 / 500V _{AC}
Capacitive load	<i>max.</i> 10 000µF	
Feedback voltage	<i>max.</i> 35V _{DC}	
Line regulation	<i>max.</i> 0.1%	350..550V _{AC}
Load regulation	<i>max.</i> 0.6% <i>max.</i> 3.1%	350..550V _{AC} 350..550V _{AC} , parallel mode
Dynamic response	<i>typ.</i> ±400mVpp	350..550V _{AC} , transient frequency 10..100Hz
Ripple & noise voltage	<i>max.</i> 10mVpp <i>max.</i> 40mVpp	350..550V _{AC} , +25..+70°C _{amb} 350..550V _{AC} , -25..+25°C _{amb}

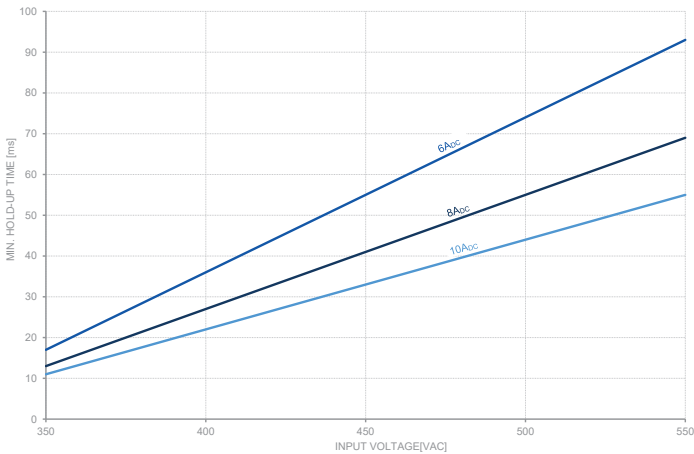

Fig. 3: Hold-up times under different load conditions and in dependence of the input voltage

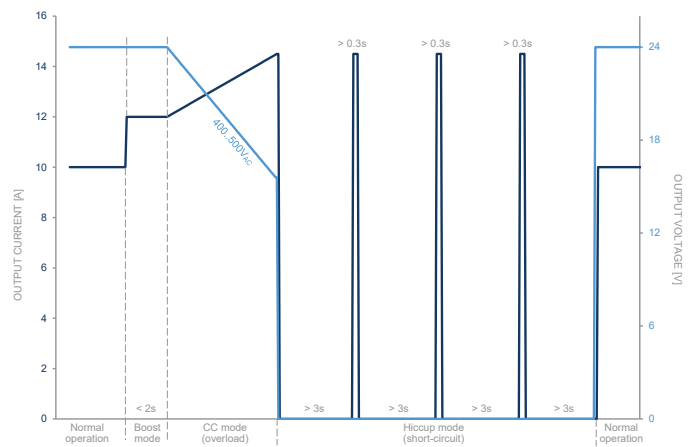

Fig. 4: Output current and voltage under different load conditions

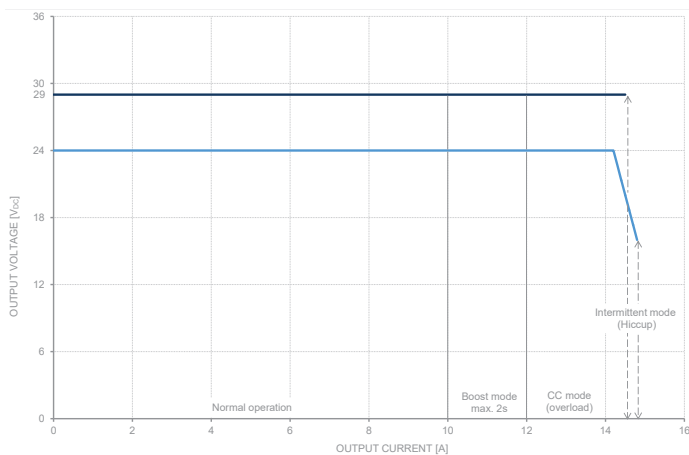

Fig. 5: Output voltage in dependence of output load current

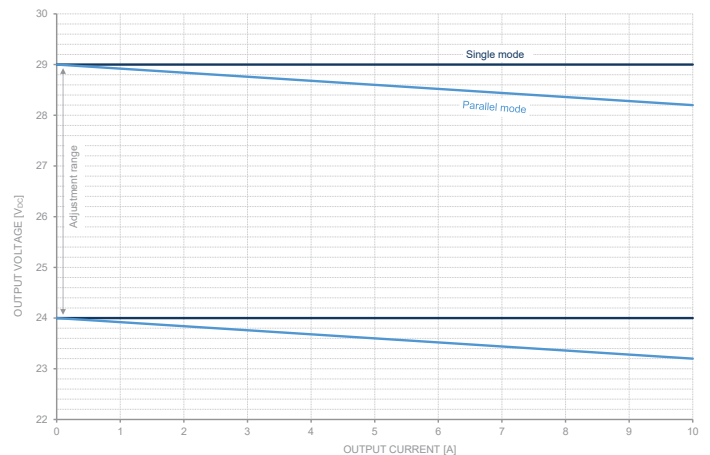

Fig. 6: Voltage drop in parallel mode depending on the load current

Unless otherwise stated, all values are specified in normal mounting position, at full load, nominal input and output voltages, 25°C (77°F) ambient temperature and a run-in time of 5 minutes.

3. Electrical input

AC power systems	TN, TT, wye	
Mains Frequency	<i>nom.</i>	50 / 60Hz
Frequency range	<i>max.</i>	47 .. 63Hz
AC input voltage [V_{ac_nom}]	<i>nom.</i>	3x400V _{AC}
Voltage range	<i>max.</i>	3x350 .. 575V _{AC}
Turn-ON voltage	<i>typ.</i>	310V _{AC}
Turn-OFF voltage	<i>typ.</i>	275V _{AC}
AC input current	<i>max.</i>	3x0.8A 400 .. 500V _{AC}
AC input current RMS	<i>max.</i>	3x0.59 / 3x0.50A 400 / 500V _{AC}
Crest factor	<i>typ.</i>	1.38 / 1.63 400 / 500V _{AC}
Inrush current	<i>max.</i>	36 / 40A 400 / 500V _{AC} , 25°C _{amb} , cold start
Inrush energy	<i>max.</i>	0.3 / 0.8A ² s 400 / 500V _{AC} , 25°C _{amb} , cold start
Input capacitance	<i>max.</i>	75μF

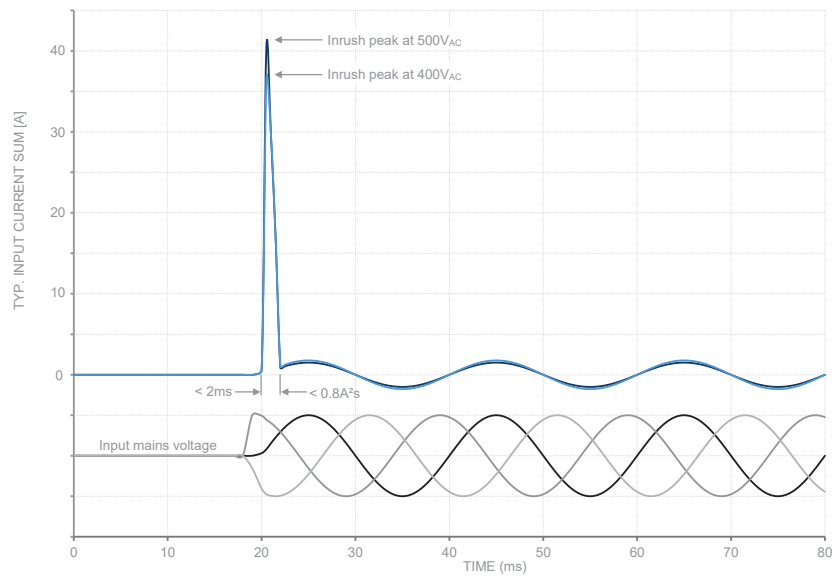

Fig. 7: Inrush current and energy during start-up phase

4. Performance

Output power [P_{out_nom}]	<i>nom.</i> 240W	
Boost power [P_{out_boost}]	<i>max.</i> 288W / 2s	see Fig. 10
Dropped phase power	<i>max.</i> 240W / continuous	2x400..500V _{AC} , not compliant with IEC/EN 61000-3-2 harmonic currents
Apparent input power	<i>typ.</i> 401 / 425 VA	400 / 500V _{AC}
Active input power	<i>typ.</i> 259 / 258 W	400 / 500V _{AC}
Reactive input power	<i>typ.</i> 307 / 338 Var	400 / 500V _{AC}
Power factor	<i>min.</i> 0.6	400..500V _{AC}
Conversion efficiency	<i>min.</i> 93.1 / 93.2% <i>avg.*</i> 92.5 / 92.1%	400 / 500V _{AC} 400 / 500V _{AC}
Power consumption	<i>max.</i> 18W <i>avg.*</i> 19.5 / 20.6W	400..500V _{AC} 400 / 500V _{AC}
Stand-by consumption	<i>max.</i> 1.6 / 2.0W	400 / 500V _{AC}

*Weighted average: 10%@P_{out}=20%, 50%@P_{out}=50%, 20%@P_{out}=80%, 20%@P_{out}=100%

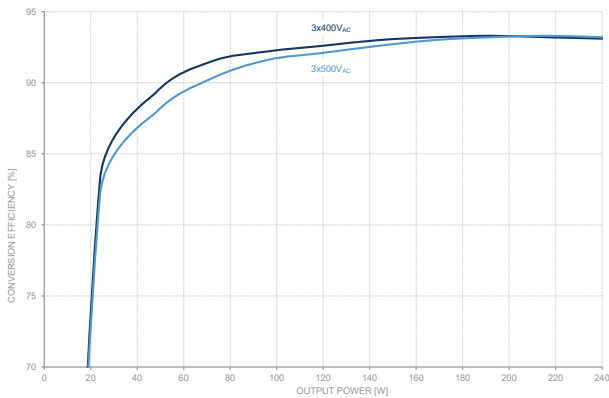

Fig. 8: Conversion efficiency in dependence of the output power

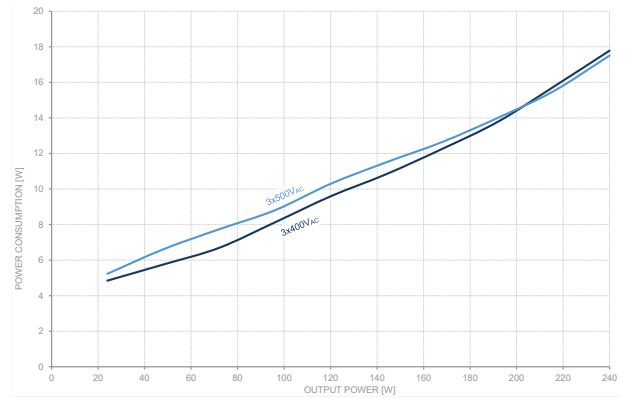

Fig. 9: Power losses in dependence of the output power

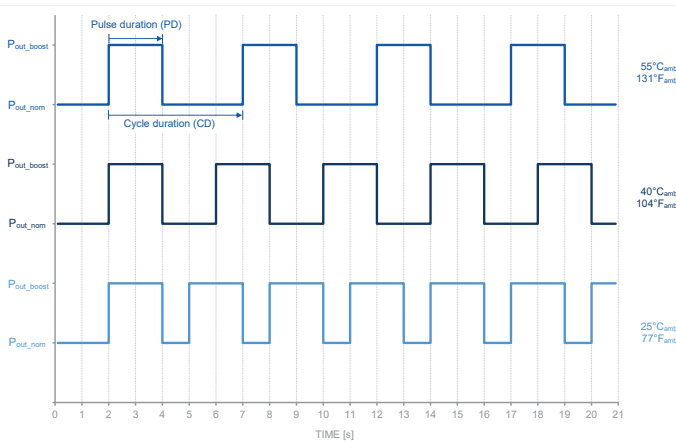

Fig. 10: Cycle duration in dependence of the ambient temperature and usage of the full boost power (120% / 2s)

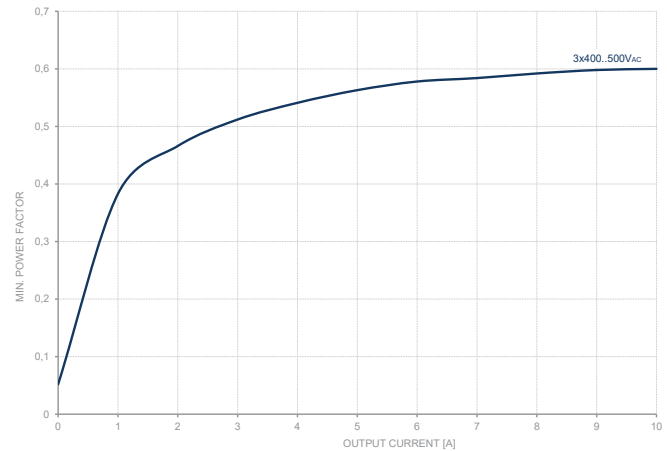

Fig. 11: Input power factor in dependence of the output current

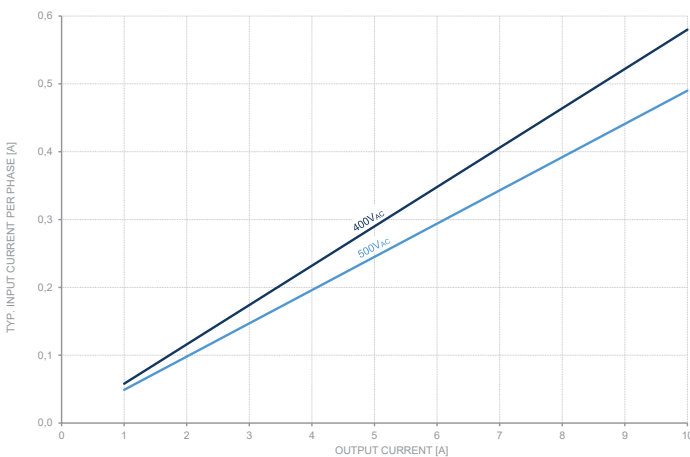

Fig. 12: Typical input current per phase in dependence of the load current

Unless otherwise stated, all values are specified in normal mounting position, at full load, nominal input and output voltages, 25°C (77°F) ambient temperature and a run-in time of 5 minutes.

5. Ambient conditions

Ambient storage temperature	<i>max.</i>	-40 .. +85°C _{amb} (-40 .. +185°F _{amb})	
Ambient operating temperature	<i>nom.</i>	-25 .. +55°C _{amb} (-13 .. +131°F _{amb})	normal mounting position
	<i>max.</i>	-25 .. +70°C _{amb} (-13 .. +158°F _{amb})	normal mounting position
Power derating	<i>min.</i>	2.4W/°C _{amb} (1.33W/°F _{amb})	>55°C _{amb} (>131°F _{amb}), not actively controlled
Cooling concept		Natural convection	
Relative storage humidity IEC 60068-2-30	<i>max.</i>	95%	non-condensing
Relative operation humidity IEC 60068-2-30	<i>max.</i>	95%	non-condensing
Operating altitude	<i>nom.</i>	3000mASL (9842ftASL)	
	<i>max.</i>	6000mASL (19685ftASL)	not UL approved
Percental power derating	<i>min.</i>	7% per 1000m (7% per 3281ft)	>3000mASL (>9842ftASL)
Temperature derating	<i>min.</i>	5°C per 1000m (9°F per 3281ft)	>3000mASL (>9842ftASL)
Atmospheric pressure	<i>nom.</i>	689hPa	
	<i>max.</i>	469 .. 1070hPa	
Pollution degree IEC 60664-1, IEC 62477-1		2	
Vibration sinusoidal IEC 60068-2-6		2g / 10 .. 500Hz, 1 hour/direction X,Y,Z	non-operating, mounted on DIN-Rail
Shock test sinusoidal halfwave IEC 60068-2-27		30g / 11ms ±5ms, 3 bumps/direction, 9 bumps total	non-operating, mounted on DIN-Rail
Audible noise		Some audible noise may be heard during no load, overload or short circuit.	

Overvoltage categories

Underlying IEC standard	61010-1	62368-1 ¹⁾	60950-1	61558-2-16 ²⁾	62477-1	61204-7	60664-1
Mains transient voltage	II	II	II	III	III	III	III
Creepage & Clearance	III	II	III	II	III	III	III

¹⁾ Edition 2

²⁾ not applicable along with IEC 61204-7

i For altitudes above 3000mASL (9842ftASL) the next lower OVC must be considered.

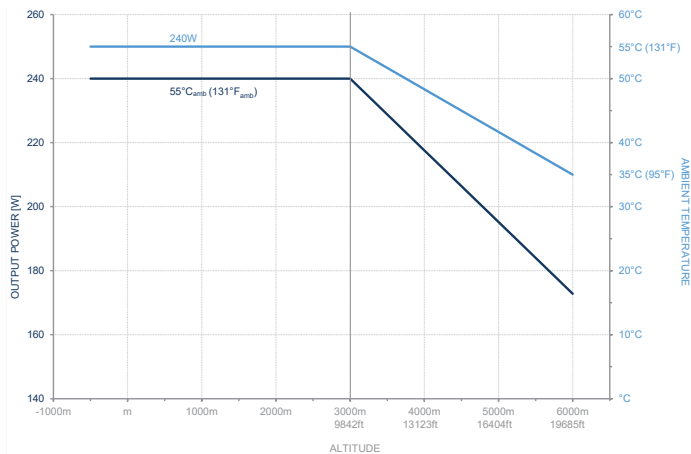

Fig. 13: Output power or ambient temperature derating at increasing altitudes

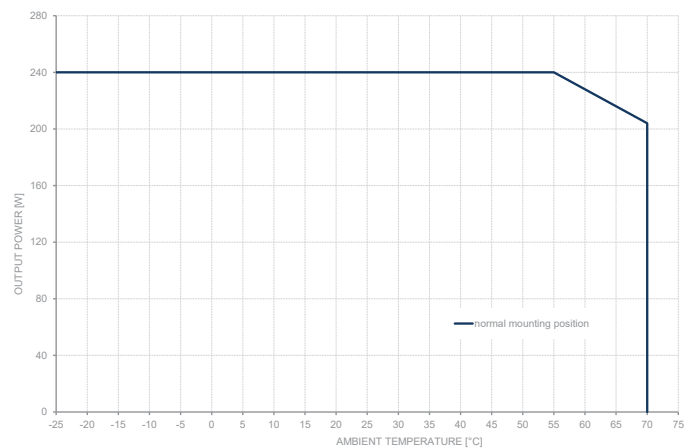

Fig. 14: Output power derating in dependence of the ambient temperature

Unless otherwise stated, all values are specified in normal mounting position, at full load, nominal input and output voltages, 25°C (77°F) ambient temperature and a run-in time of 5 minutes.

6. Reliability and Service lifetime

Service lifetime	<i>min.</i>	44 000 / 48 000hrs	400 / 500V _{AC} , 100% P _{out} , 40°C _{amb} , 24h operating
	<i>min.</i>	82 000 / 78 000hrs	400 / 500V _{AC} , 75% P _{out} , 40°C _{amb} , 24h operating
	<i>min.</i>	125 000 / 136 000hrs	400 / 500V _{AC} , 100% P _{out} , 25°C _{amb} , 24h operating
Early life MTBF Telcordia SR-332 Issue 4	<i>min.</i>	1.1M / 1.0M / 0.8M hrs	P _{out_nom} , 25 / 40 / 55°C _{amb}
Service life MTBF Telcordia SR-332 Issue 4	<i>min.</i>	5.7M / 4.0M / 2.3M hrs	P _{out_nom} , 25 / 40 / 55°C _{amb}

i The maximum service lifetime guaranteed by the eCap manufacturer is 131 400hrs (15 years). All values above are theoretically calculated.

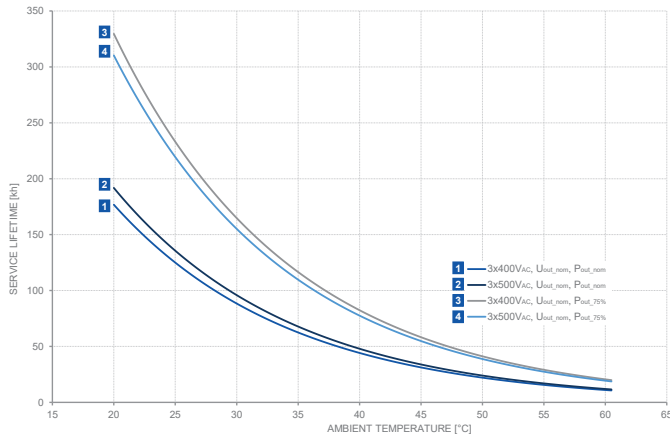

Fig. 15: Power supply service lifetime in dependence of ambient temperature

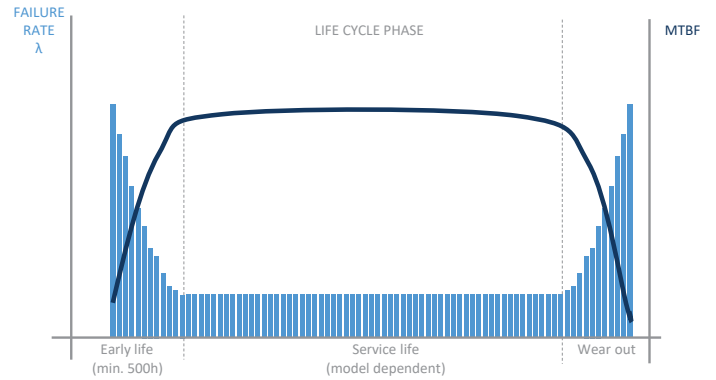

Fig. 16: Generic diagram visualising failure rate and MTBF values during the product's life-cycle

7. Dimensions & Mechanical data

Enclosure material	Aluminum	
Cover material	Aluminum	
Inflammability class	V0	Enclosure, cover and terminals
UL 94		
Width	55.0mm (2 ¹¹ / ₆₄ in)	
Height	129.0mm (5 ⁵ / ₆₄ in)	
Depth	w/o DIN-Rail	
Screw terminal model (-A0)	135.7mm (5 ¹¹ / ₃₂ in)	
Push-in terminal model (-A1)	138.2mm (5 ⁷ / ₁₆ in)	
Weight	780g (1.72lb)	
Lever arm	max. 62mm (2 ⁷ / ₁₆ in)	into the direction of Y axis
Torsional moment on DIN-Rail	max. 0.47Nm (4.16lb in)	into the direction of Z axis
Enclosure openings	max. 7mm (9/ ₃₂ in)	
DIN-Rail types	TH 35-7.5, TH 35-15	
IEC 60715		

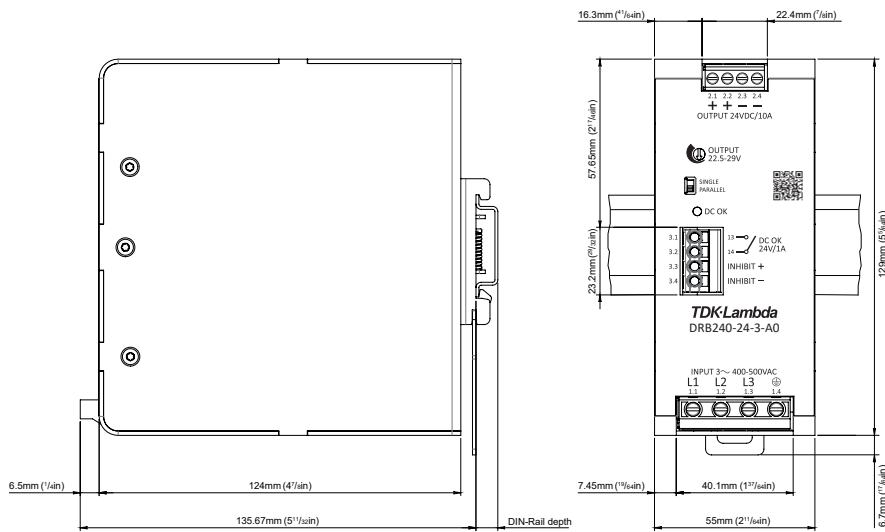

Fig. 17: Dimension drawing of DRB240-24-3-A0

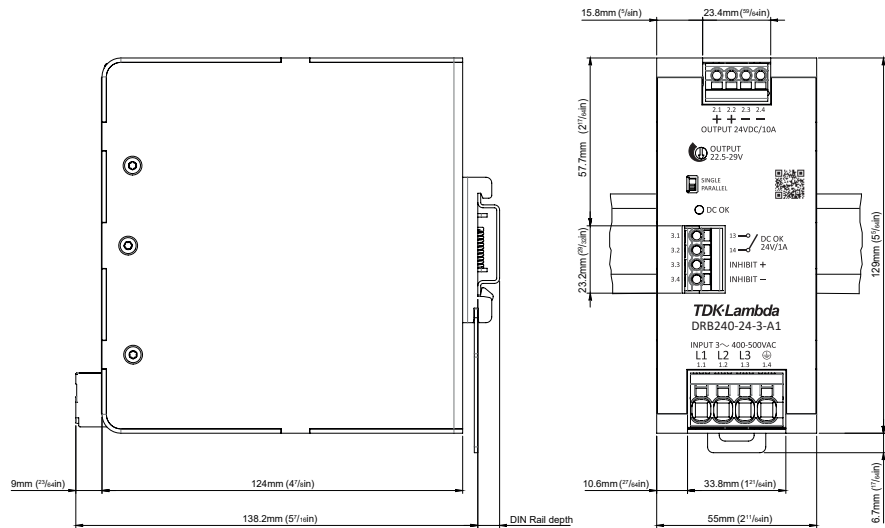
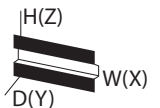

Fig. 18: Dimension drawing of DRB240-24-3-A1



8. Installation clearances

Vertically (Z axis)

Top side	1	<i>min.</i> 40mm ($1^{37}/64$ in)	installation above heat sources not permitted
Bottom side	2	<i>min.</i> 30mm ($1^{3}/16$ in)	

Horizontally (X axis)

Left side	3	<i>min.</i> 15mm ($1^{9}/32$ in)	to active components (heat sources) to active components (heat sources)
Right side	4	<i>min.</i> 15mm ($1^{9}/32$ in)	
Left side	3	<i>min.</i> 5mm ($1^{3}/64$ in)	
Right side	4	<i>min.</i> 5mm ($1^{3}/64$ in)	

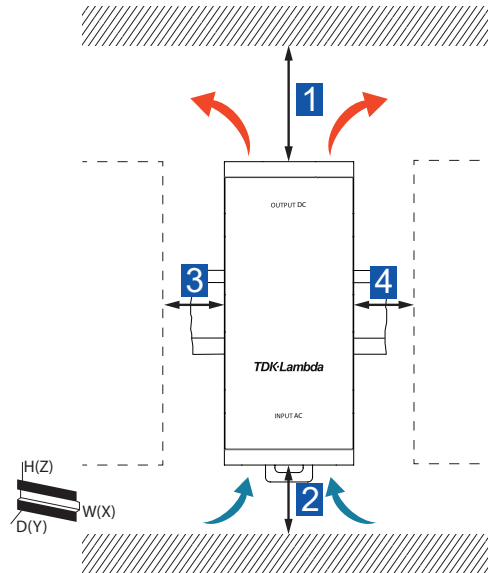

Fig. 19: Installation clearances in normal mounting position

9. Wiring & Connection

	Input	Output	Signaling
DRB240-24-3-A0			
Terminal type	Slotted screw	Slotted screw	Push-in
Recommended screw driver	SL 0.8x4.0mm (SL $1^{1}/32 \times 1^{1}/8$ in)	SL 0.6x3.5mm (SL $1^{1}/32 \times 9^{1}/64$ in)	SL 0.5x3.0mm (SL $1^{1}/64 \times 1^{1}/8$ in)
Solid wire	0.5-4.0mm ² (16-10AWG)	0.5-2.5mm ² (24-12AWG)	0.2-2.5mm ² (26-12AWG)
Flexible wire	0.5-4.0mm ² (16-10AWG)	0.5-2.5mm ² (24-12AWG)	0.2-2.5mm ² (26-12AWG)
Standard ferrules	0.25-2.5mm ²	0.25-1.5mm ²	0.2-1.5mm ²
Uninsulated ferrules	0.25-2.5mm ²	0.25-1.5mm ²	0.2-2.5mm ²
Stripping length	6-7mm ($1^{5}/64 - 9^{1}/32$ in)	7-8mm ($9^{1}/32 - 5^{1}/16$ in)	9-10mm ($2^{3}/64 - 2^{5}/64$ in)
Tightening torque	0.5-0.8Nm (4.4-7.0lb in)	0.5Nm (4.4lb in)	-
DRB240-24-3-A1			
Terminal type	Push-in	Push-in	Push-in
Recommended screw driver	SL 0.6x3.5mm (SL $1^{1}/32 \times 9^{1}/64$ in)	SL 0.5x3.0mm (SL $1^{1}/64 \times 1^{1}/8$ in)	SL 0.5x3.0mm (SL $1^{1}/64 \times 1^{1}/8$ in)
Solid wire	0.2-10.0mm ² (24-8AWG)	0.2-2.5mm ² (26-12AWG)	0.2-2.5mm ² (26-12AWG)
Flexible wire	0.2-6.0mm ² (24-8AWG)	0.2-2.5mm ² (26-12AWG)	0.2-2.5mm ² (26-12AWG)
Standard ferrules	0.25-4.0mm ²	0.2-1.5mm ²	0.2-1.5mm ²
Uninsulated ferrules	0.25-6.0mm ²	0.2-2.5mm ²	0.2-2.5mm ²
Stripping length	15mm ($1^{9}/32$ in)	9-10mm ($2^{3}/64 - 2^{5}/64$ in)	9-10mm ($2^{3}/64 - 2^{5}/64$ in)

i In compliance to IEC/EN/UL 62368-1 (Ed.2) ferrules are required if flexible wires are used. In compliance with IEC/EN/UL 61010-1, 61010-2-201 appropriate copper wires must be used that withstand operating temperatures of at least 75°C (167°F) in ambients NOT exceeding 40°C (104°F), and 90°C (194°F) in ambients exceeding 40°C (104°F).

10. Signaling & Control

DC OK

Type		Relay contact	
Characteristic		N/O	
Closing		$U_{out} > 95\% U_{set}$	duration min. 100ms
Opening		$U_{out} < 90\% U_{set}$	duration min. 100ms
Resistive load	max.	1A	24V _{DC}
Trigger hysteresis	typ.	1.2V	

Remote ON/OFF

Type		Electrical contact	
Characteristic		Inhibit	
ON threshold	typ.	6V	
OFF threshold	typ.	4V	
Restart delay	max.	5s	
Open circuit voltage	max.	30V	OFF mode
Current	max.	10mA	ON mode
Reference potential		DC-	
Parallel connection		yes	
Active discharging		no	OFF mode

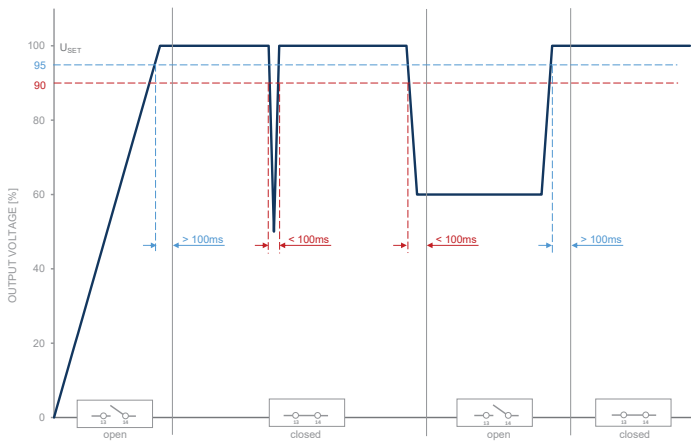

Fig. 20: DC-OK relay characteristic in dependence of output voltage changes

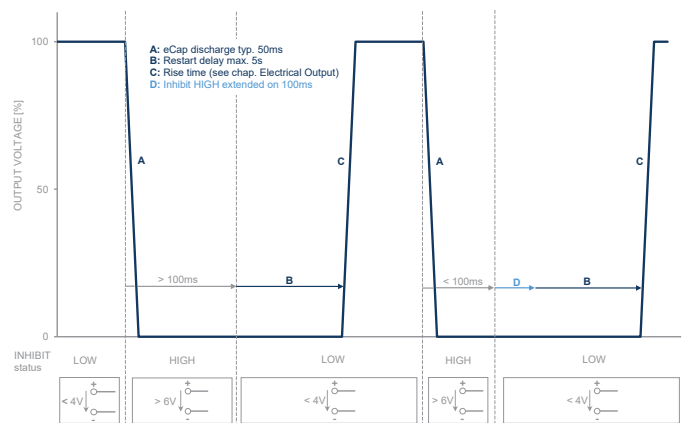

Fig. 21: Control of the output voltage in dependence of the inhibit relay status.

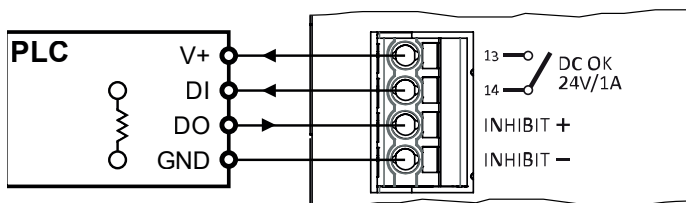

Fig. 22: Generic connection diagram of DC OK and INHIBIT contacts

11. Block diagram

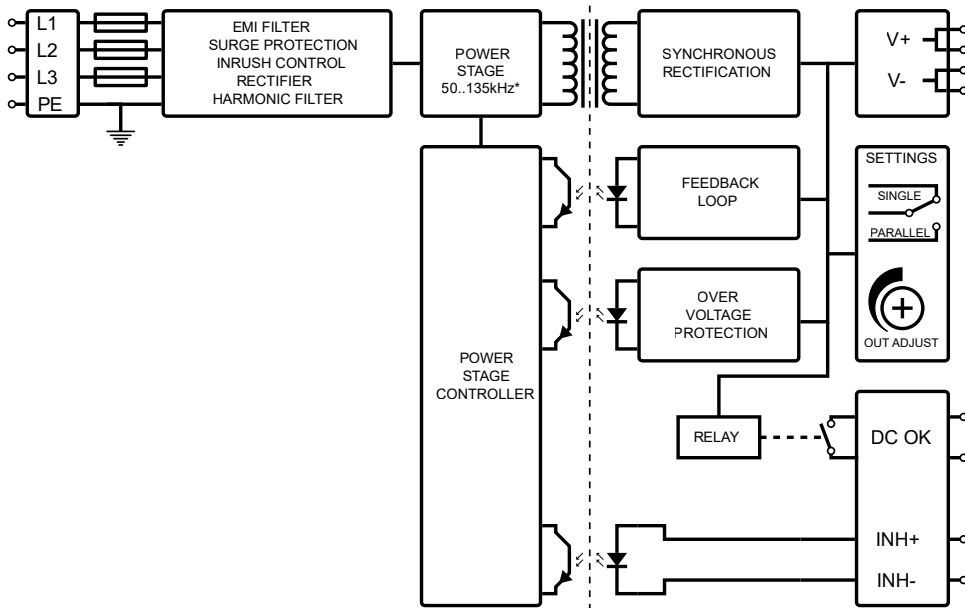

Fig. 23: Functional block diagram

*dependent on U_{out} and I_{out}

12. Device protection

Ingress protection degree IEC 60529	IP 20	
NEMA classification NEMA 250-2018	NEMA 1	
Overvoltage protection	<i>max.</i> 32V _{DC} auto-recovery	
Undervoltage protection (UVP)	<i>max.</i> 270V _{AC}	
Overtemperature protection (OTP)	<i>max.</i> 80°C _{amb} (176°F _{amb}) auto-recovery	85% P _{out}
Overcurrent protection (OCP)	<i>max.</i> 150% auto-recovery	
Integrated input fuse	3x T3.15A at L pins	not DC capable, not user replaceable
Suitable MCB types IEC 60898-1	B or C characteristic, 6/8/10A	
Transient protection		
1st level	MOV (Metal Oxide Varistor)	
2nd level	GDT (Gas Discharge Tube)	

13. Electrical Safety

Class of protection IEC 61140	I	PE connection required
Safety Extra Low Voltage IEC 61010-1	SELV	
Protective Extra Low Voltage IEC 60204-1	PELV	Output must be earthed in the end application
Protective ground resistance	<i>max.</i> 100mΩ	
Ground leakage current IEC 60990	<i>max.</i> 0.9mA <i>max.</i> 1.0mA	TN/TT mains, 3x575V _{AC} , 50Hz TN/TT mains, 3x575V _{AC} , 60Hz
Touch current IEC 60990	<i>max.</i> 40μA <i>max.</i> 50μA	TN/TT mains, 3x575V _{AC} , 50Hz TN/TT mains, 3x575V _{AC} , 60Hz

Insulation strength	Type test (60s) IEC 61010-1	Routine test (3s) IEC 61010-1	Field test (3s)
Input / Output	3510V _{AC}	3510V _{AC}	3510V _{AC}
Input / PE	2210V _{AC}	2210V _{AC}	2210V _{AC}
Input / DC OK	3510V _{AC}		3510V _{AC}
Input / INHIBIT	3510V _{AC}		3510V _{AC}
Output / PE	1390V _{AC}	1390V _{AC}	1390V _{AC}
Output / DC OK	1390V _{AC}		1390V _{AC}
Output / INHIBIT	1390V _{AC}		1390V _{AC}
DC OK / INHIBIT	1390V _{AC}		1390V _{AC}

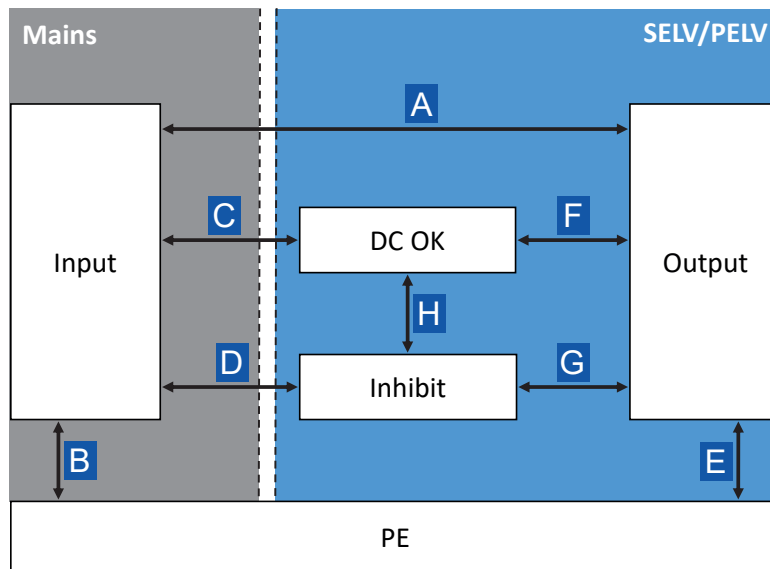

Fig. 24: Schematic of the insulation paths

14. Electromagnetic immunity

Investigated under generic standards IEC/EN 61000-6-2 (2019) - Immunity for industrial environments.

Electrostatic contact discharge IEC/EN 61000-4-2	4kV	Criterion A	330Ω / 150pF
Electrostatic air discharge IEC/EN 61000-4-2	8kV	Criterion A	330Ω / 150pF
Electromagnetic RF field¹⁾ IEC/EN 61000-4-3	10V/m	Criterion A	80MHz.. 1GHz
	3V/m	Criterion A	1.4GHz.. 2GHz
	1V/m	Criterion A	2GHz.. 2.7GHz
Fast transients (burst) IEC/EN 61000-4-4			
Input ²⁾	4kV	Criterion A	5kHz
Output	2kV	Criterion A	5kHz
Signal contact ²⁾	2kV	Criterion A	5kHz
Surge voltages IEC/EN 61000-4-5			
Input symmetrical (L-L) ²⁾	2kV	Criterion A	2Ω+18μF, for Φ = 0°, 90°, 180°, 270°
Input asymmetrical (L-PE) ²⁾	4kV	Criterion A	12Ω+9μF, for Φ = 0°, 90°, 180°, 270°
Output symmetrical (L-L)	0.5kV	Criterion A	2Ω+18μF
Output asymmetrical (L-PE)	1kV	Criterion A	12Ω+9μF
Conducted disturbances Input, signal line, PE³⁾ IEC/EN 61000-4-6	10V	Criterion A	150kHz.. 80MHz
Power frequency magnetic field IEC/EN 61000-4-8	30A/m	Criterion A	50Hz, 60s each axis (x, y, z)
Voltage dips/sags and interruptions IEC/EN 61000-4-11, 61000-4-34	500ms	Criterion A	400VAC at 70%, 50Hz
	200ms	Criterion A	400VAC at 40%, 50Hz
	20ms	Criterion A	400VAC at 0%, 50Hz
	5000ms	Criterion C	400VAC at 0%, 50Hz

¹ Except for the ITU broadcast frequency bands 87..107MHz, 174..230MHz and 470..790MHz, where the level shall be 3V/m.

² Exceeds the requirements of the European Low Voltage Directive 2014/35/EU

³ Except for the ITU broadcast frequency bands 47..68MHz, where the level shall be 3V.

Performance level definitions:

Criterion A:

The device continues operation as intended during and after the test. The specified performance level accepts a change of ±10% on nominal output voltage and current. There is neither a violation of the performance level, nor a loss of function if the device is used as intended.

Criterion B:

The device continues operation as intended after the test. The specified performance level accepts a change of ±10% on nominal output voltage and current. There is neither a violation of the performance level, nor a loss of function if the device is used as intended. During the test a violation of the performance level is allowed.

Criterion C:

A temporary loss of function is allowed, provided the function is auto-recoverable, or can be restored by the operation of the controls.



15. Electromagnetic emission

Investigated under generic standards IEC/EN 61000-6-3 (2007) + A1 (2011) / AC (2012) - Emission standard for residential, commercial and light-industrial environments.

Conducted noise emission Input EN 55011, CISPR 11	Class B	150kHz.. 30MHz
Radiated noise emission Input EN 55011, CISPR 11	Class B	30MHz.. 1GHz
Harmonic currents Input IEC/EN 61000-3-2	Class A	0kHz.. 2kHz
Voltage changes, voltage fluctuations and flicker Input IEC/EN 61000-3-3	PASS	50Hz

Unless otherwise stated, all values are specified in normal mounting position, at full load, nominal input and output voltages, 25°C (77°F) ambient temperature and a run-in time of 5 minutes.

16. Certifications







	UL 61010-1 CAN/CSA-C22.2 No. 61010-1	Safety requirements for electrical equipment for measurement, control, and laboratory use - Part 1: General requirements
	UL 61010-2-201 CAN/CSA-C22.2 No. 61010-2-201	Safety requirements for electrical equipment for measurement, control, and laboratory use - Part 2-201: Particular requirements for control equipment UL-File: E356563
	IEC EN 61010-1	Safety requirements for electrical equipment for measurement, control, and laboratory use - Part 1: General requirements
	IEC EN 61010-2-201	Safety requirements for electrical equipment for measurement, control, and laboratory use - Part 2-201: Particular requirements for control equipment
	IEC EN 62368-1 (Ed.2)	Audio/video, information and communication technology equipment - Part 1: Safety requirements
	UL 62368-1 (Ed. 2)	Audio/video, information and communication technology equipment - Part 1: Safety requirements UL-File: E511889

17. Additional safety standards

The safety design of the product complies additionally with the following harmonised standards.

IEC 60950-1	Information technology equipment - Safety - Part 1: General requirements
IEC/EN 62477-1	Safety requirements for power electronic converter systems and equipment - Part 1: General
IEC/EN 61204-7	Low-voltage switch mode power supplies - Part 7: Safety requirements
IEC/EN 61558-2-16	Safety of transformers, reactors, power supply units and similar products for supply voltages up to 1100 V - Part 2-16: Particular requirements and tests for switch mode power supply units and transformers for switch mode power supply units
EN 60204-1	Safety of machinery - Electrical equipment of machines - Part 1: General requirements

18. Compliance & Registration

	Conformity with health, safety, and environmental protection standards for products sold within the European Economic Area (EEA).
	UKCA (UK Conformity Assessed) is the product marking that is used for certain goods being placed on the United Kingdom market.
	Registration mark to indicate products conformity to the technical regulations of the Eurasian Customs Union (Russia, Belarus, Armenia, Kazakhstan and Kyrgyzstan).
	The Waste Electrical and Electronic Equipment Directive (WEEE Directive) is the European Community Directive 2012/19/EU on collection, recycling and recovery targets for all types of electrical goods.
	The Restriction of Hazardous Substances Directive 2011/65/EU (RoHS 2) regulates the use of certain hazardous substances in electrical and electronic equipment.
	Registration, Evaluation, Authorisation and Restriction of Chemicals (REACH) is a European Union regulation that addresses the production and use of chemical substances, and their potential impacts on both human health and the environment.

Unless otherwise stated, all values are specified in normal mounting position, at full load, nominal input and output voltages, 25°C (77°F) ambient temperature and a run-in time of 5 minutes.

19. Typical use-cases

19.1 Parallel Operation

For the purpose of power increase, power supplies can be paralleled. Furthermore, a paralleling can be done for limited redundancy purposes in order to backup malfunctions occurring on the primary (AC) side of the power supplies. The following measures must be taken into account:

- ▶ Only power supplies of the same series and power rating must be paralleled
- ▶ The dip switch on the front side of the power supplies must be switched to PARALLEL
- ▶ Load wiring shall be identical in terms of length and cross section
- ▶ The output voltage of the power supplies shall be adjusted to the same value ($\pm 100\text{mV}$)
- ▶ All paralleled power supplies must be operated under the same ambient conditions
- ▶ The power supplies must not be operated under any condition which requires a power derating (e.g. altitudes above 3000mASL (9842ftASL), temperatures above $55^\circ\text{C}_{\text{amb}}$ ($131^\circ\text{F}_{\text{amb}}$), etc.)
- ▶ If more than three power supplies are paralleled, each output must be protected by a decoupling module (e.g. DRM series), MCB, diode, or fuse
- ▶ The increased installation clearances must be considered (see "Installation clearances" on page 12)

i In parallel operations the values of output load regulation, inrush currents, EMI, harmonic and leakage currents will increase.

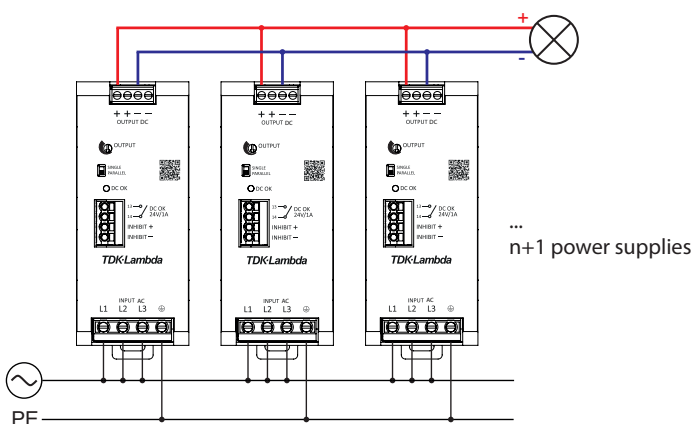

Fig. 25: Connection scheme for paralleling n+1 power supplies

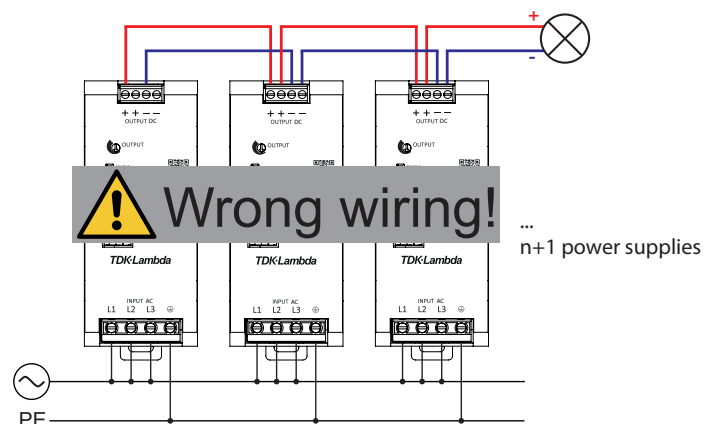

Fig. 26: Example scheme of wrong parallel wiring

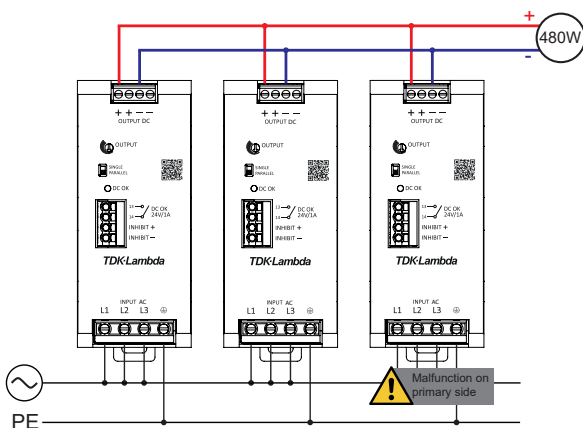

Fig. 27: Example of a 480W application with limited redundancy

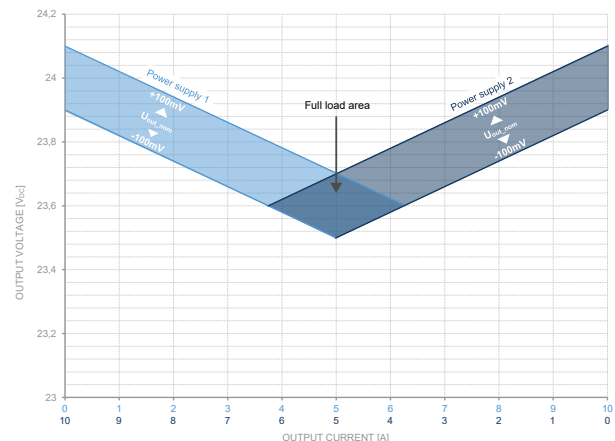



Fig. 28: Schematic of load sharing in PARALLEL mode if PSUs are adjusted to $U_{\text{out_nom}} \pm 100\text{mV}$

19.2 Series operation

For the purpose of higher load voltages, power supplies can be connected in series. The following measures must be taken into account:

- ▶ The output voltage sum must not exceed 250V_{DC}
- ▶ If the output voltage sum exceeds 60V_{DC}, a safeguard against unintended touching must be considered
- ▶ Only power supplies of the same series and power rating must be connected in series
- ▶ The dip switch on the front side of the power supplies must be switched to SINGLE
- ▶ All power supplies in series must be operated under the same ambient conditions
- ▶ The power supplies must not be operated under any condition which requires a power derating (e.g. altitudes above 3000mASL (9842ftASL), temperatures above 55°C_{amb} (131°F_{amb}), etc.)
- ▶ The increased installation clearances must be considered (see "Installation clearances" on page 12)

 In series operations the values of output load regulation, inrush currents, EMI, harmonic and leakage currents will increase.

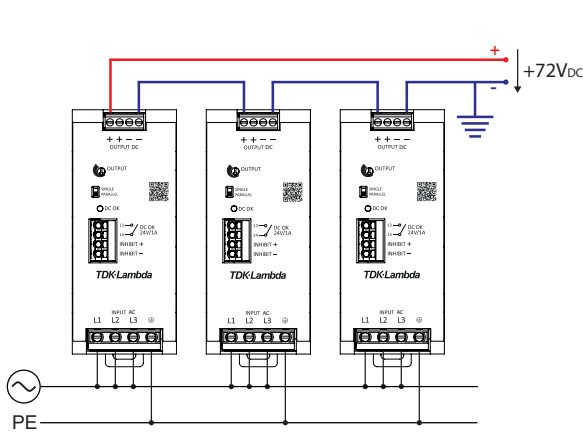

Fig. 29: Connection scheme for series operation with positive voltage level

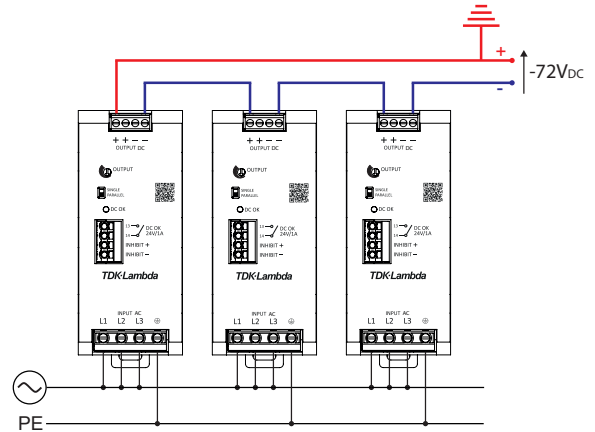

Fig. 30: Connection scheme for series operation with negative voltage level

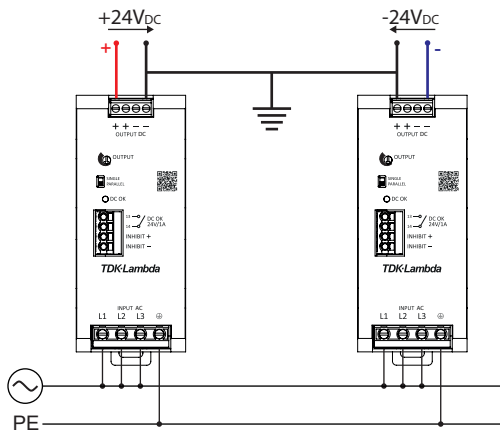

Fig. 31: Connection scheme for series operation with centre tap

19.3 Two-phase operation

The device is capable to run continuously on two phases of a 3-phase power grid. A power derating is not required if all parameters stay within the technical product specification. In particular, all conditions associated with a power derating must be carefully considered.

Please note if running on two phases:

- ▶ Power losses will increase and can no longer be guaranteed as specified for 3-phase operation
- ▶ Hold-up times as specified for 3-phase operation can no longer be guaranteed
- ▶ The device will go into OTP mode if operating permanently at input voltages below 350V_{AC}
- ▶ The device is no more compliant with IEC/EN 61000-3-2 harmonic current limits
- ▶ Safety approvals under UL 61010-1, -2-201 and UL 62368-1 (Ed.2) are no more applicable

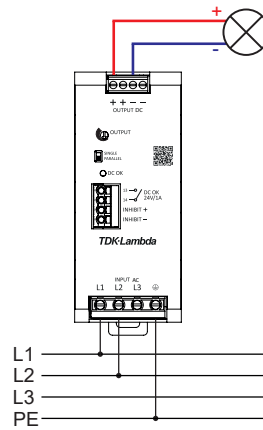

Fig. 32: Connection diagram for 2-phase operation

Figures register

Fig. 1: Illustration of the spatial axis with reference to the DIN-Rail	5
Fig. 2: Description of user elements.....	5
Fig. 3: Hold-up times under different load conditions and in dependence of the input voltage.....	6
Fig. 4: Output current and voltage under different load conditions	6
Fig. 5: Output voltage in dependence of output load current.....	6
Fig. 6: Voltage drop in parallel mode depending on the load current.....	6
Fig. 7: Inrush current and energy during start-up phase	7
Fig. 8: Conversion efficiency in dependence of the output power.....	8
Fig. 9: Power losses in dependence of the output power	8
Fig. 10: Cycle duration in dependence of the ambient temperature and usage of the full boost power (120% / 2s).....	8
Fig. 11: Input power factor in dependence of the output current.....	8
Fig. 12: Typical input current per phase in dependence of the load current	8
Fig. 13: Output power or ambient temperature derating at increasing altitudes	9
Fig. 14: Output power derating in dependence of the ambient temperature.....	9
Fig. 15: Power supply service lifetime in dependence of ambient temperature	10
Fig. 16: Generic diagram visualising failure rate and MTBF values during the products life-cycle	10
Fig. 17: Dimension drawing of DRB240-24-3-A0	11
Fig. 18: Dimension drawing of DRB240-24-3-A1	11
Fig. 19: Installation clearances in normal mounting position.....	12
Fig. 20: DC-OK relay characteristic in dependence of output voltage changes.....	13
Fig. 21: Control of the output voltage in dependence of the inhibit relay status.....	13
Fig. 22: Generic connection diagram of DC OK and INHIBIT contacts.....	13
Fig. 23: Functional block diagram	14
Fig. 24: Schematic of the insulation paths	15
Fig. 25: Connection scheme for paralleling n+1 power supplies	18
Fig. 26: Example scheme of wrong parallel wiring.....	18
Fig. 27: Example of a 480W application with limited redundancy	18
Fig. 28: Schematic of load sharing in PARALLEL mode if PSUs are adjusted to $U_{out_nom} \pm 100mV$	18
Fig. 29: Connection scheme for series operation with positive voltage level	19
Fig. 30: Connection scheme for series operation with negative voltage level.....	19
Fig. 31: Connection scheme for series operation with centre tap	19
Fig. 32: Connection diagram for 2-phase operation.....	20



TDK-Lambda France SAS

Tel: +33 1 60 12 71 65
france@fr.tdk-lambda.com
www.emea.lambda.tdk.com/fr



Italy Sales Office

Tel: +39 02 61 29 38 63
info.italia@it.tdk-lambda.com
www.emea.lambda.tdk.com/it



Netherlands

info@nl.tdk-lambda.com
www.emea.lambda.tdk.com/nl



TDK-Lambda Germany GmbH

Tel: +49 7841 666 0
info@de.tdk-lambda.com
www.emea.lambda.tdk.com/de



Austria Sales Office

Tel: +43 2256 655 84
info@at.tdk-lambda.com
www.emea.lambda.tdk.com/at



Switzerland Sales Office

Tel: +41 44 850 53 53
info@ch.tdk-lambda.com
www.emea.lambda.tdk.com/ch



Nordic Sales Office

Tel: +45 8853 8086
info@dk.tdk-lambda.com
www.emea.lambda.tdk.com/dk

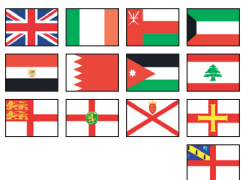

TDK-Lambda UK Ltd.

Tel: +44 (0) 12 71 85 66 66
powersolutions@uk.tdk-lambda.com
www.emea.lambda.tdk.com/uk



TDK-Lambda Ltd.

Tel: +9 723 902 4333
info@tdk-lambda.co.il
www.emea.lambda.tdk.com/il



C.I.S.

Commercial Support:

Tel: +7 (495) 665 2627

Technical Support:

Tel: +7 (812) 658 0463

info@tdk-lambda.ru

www.emea.lambda.tdk.com/ru



TDK-Lambda Americas

Tel: +1 800-LAMBDA-4 or 1-800-526-2324
powersolutions@us.tdk-lambda.com
www.us.lambda.tdk.com



TDK Electronics do Brasil Ltda

Tel: +55 11 3289-9599
sales.br@tdk-electronics.tdk.com
www.tdk-electronics.tdk.com/en



TDK-Lambda Corporation

Tel: +81-3-6778-1113
www.jp.lambda.tdk.com



TDK-Lambda (China) Electronics Co. Ltd.

Tel: +86 21 6485-0777
powersolutions@cn.tdk-lambda.com
www.lambda.tdk.com.cn



TDK-Lambda Singapore Pte Ltd.

Tel: +65 6251 7211
tts.mkt@sg.tdk-lambda.com
www.sg.lambda.tdk.com



TDK India Private Limited, Power Supply Division

Tel: +91 80 4039-0660
mathew.philip@in.tdk-lambda.com
www.sg.lambda.tdk.com

For further information please visit:
<https://www.emea.lambda.tdk.com/drb-3-phase>

