

DFE252008U-4R7M#

indicates a package specification code.



< List of part numbers with package codes >
DFE252008U-4R7M=P2

Shape

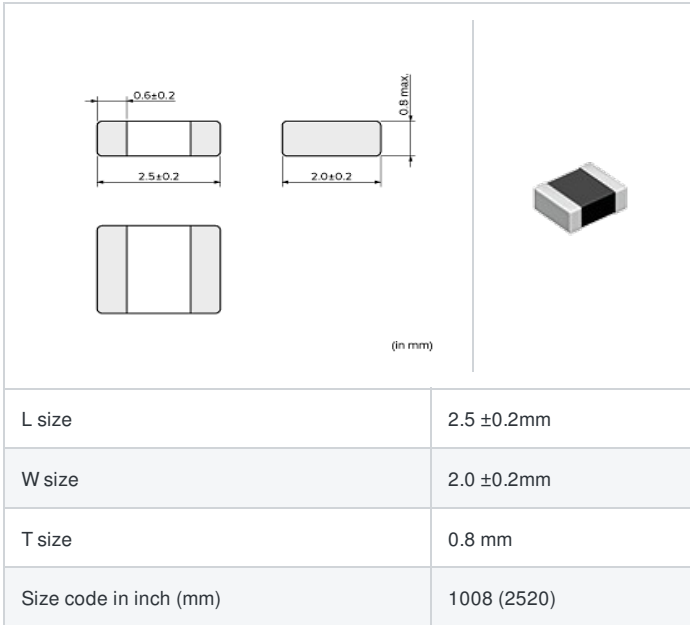

Notes

Rated current (I_{sat}) is specified when the decrease of the initial inductance value at 30%. (The ambient reference temperature is 20°C.)
Rated current (I_{temp}) is specified when temperature of inductor the is raised 40°C by DC current. (The ambient reference temperature is 20°C.)

References

Packaging code	Specifications	Minimum quantity
=P2	φ 180mm Embossed taping	3000

Mass (Typ.)	
1 piece	0.0184g

Specifications

Inductance	4.7μH ±20%
Inductance test frequency	1MHz
Rated current (I _{sat}) (Based on Inductance change)	1600mA
Rated current (I _{temp}) (Based on Temperature rise)	1000mA
Max. of DC resistance	0.340Ω
Operating temperature range (Self-temperature rise is included)	-40~85°C
Class of magnetic shield	Metal Alloy
Absolute maximum voltage	20V DC
Series	DFE252008U

Attention

- 1.This datasheet is downloaded from the website of Murata Manufacturing Co., Ltd. Therefore, it's specifications are subject to change or our products in it may be discontinued without advance notice. Please check with our sales representatives or product engineers before ordering.
- 2.This datasheet has only typical specifications because there is no space for detailed specifications. Therefore, please review our product specifications or consult the approval sheet for product specifications before ordering.