

■ Features

1. High current capacity

Capable of going to a max. of 65A when using 8 AWG with the single position connector. (Please refer to the chart for the rated current in other pin counts.)

2. Secure lock mechanism ensures complete mating

A secure lock mechanism with a clear tactile and audible click prevents insufficient mating. (Fig.2)

3. Highly reliable 5-point contact structure

Three independent contact springs provide a secure contact with high contact reliability using 5-point of contact. (Fig.3)

4. Molded lance design

The lance is actually part of the housing instead of being part of the terminal. This prevents tangled wires during assembly.

5. Mis-insertion prevention for headers

The addition of a molded pin on the header allows temporary mounting retention and prevents reverse mounting on the PCB. (Fig.1). (Right angle pin header has a metal fitting for this purpose)

6. Prevention of solder cracks

Glass-reinforced resin is used on pin header to prevent solder cracks due to thermal contraction.

7. Design Prevents short-circuits between contacts

The wall structure between contacts isolates the contacts and prevents short circuits from occurring. (Fig.1)

8. Compliant to UL, C-UL and TÜV specifications

9. Glow Wire compliance(Compliant with IEC 60695-2-11)

10. Finger-safe (Electric shock prevention) type available

● Lock structure

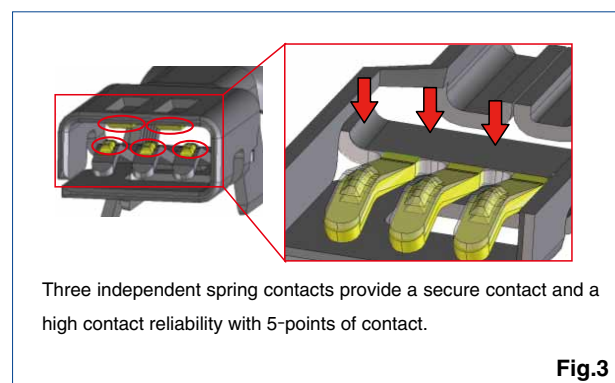
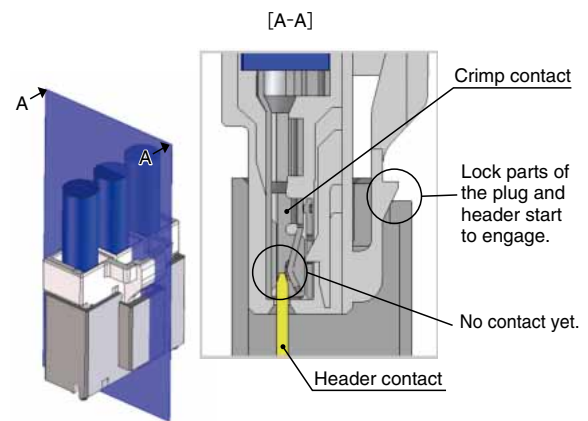

Product Specifications

Ratings	Current Rating (Note 1)	No. of Contacts	8 AWG	10 AWG	12 AWG	Operating Temperature -55~105°C (Note 2)
		1	50A	40A	31A	Operating Humidity Range 20~80%
		2	45A	35A	28A	Storage Temperature Range -10~60°C (Note 3)
		3				Storage Humidity Range 40~70%
		4	42A	33A	27A	UL/TÜV file No. and certification No.
		5				UL : E52653
	6	C-UL : E52653 TÜV : R50244085				
Voltage Rating	AC/DC 1,000V				R5040864 (DF60F)	

	Current Rating	Voltage Rating
UL	See below table	AC/DC 600V
C-UL	See upper table (Δt=30°C)	AC/DC 600V
TÜV	See upper table	AC/DC 600V

Current rating of UL Standards (Ambient temperature : 25°C) (Note 1)	No. of Contacts	8 AWG	10 AWG	12 AWG
	1	65A	55A	45A
	2			40A
	3	55A	50A	45A
	4			
	5			
6	35A			

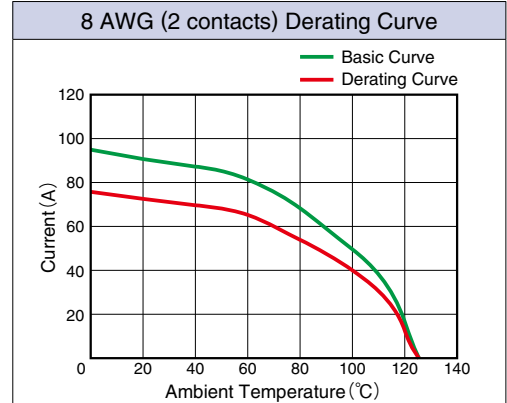

Note : The derating curve is derived from the basic curve multiplied by the derating factor of 0.8.

Item	Specifications	Conditions
1. Insulation resistance	No less than 1,000MΩ	Measured at DC=1,000V
2. Withstand voltage	No flashover or breakdown	AC 3,000V applied for 1 minute.
3. Contact resistance	No more than 2mΩ	Measured at 1A and not greater than 6V
4. Vibration Resistance	No electrical discontinuity of 1μs or greater	Frequency 10 - 500Hz, accelerated velocity 98 m/s ² , 2 hours for each of the three axis directions
5. Shock Resistance	No electrical discontinuity of 1μs or greater	Accelerated velocity : 490m/s ² , for 11 ms, half-sine wave form in 3 directions, 3 times for each of the three directions
6. Moisture-resistance	Contact resistance : no more than 2mΩ ; insulation resistance : no less than 1,000MΩ	Temperature : 40±2°C; humidity : 90 to 95%, left for 96 hours
7. Temperature cycles	Contact resistance : no more than 2mΩ ; insulation resistance : no less than 1,000MΩ	-55°C : 30 minutes → 85°C : 30 minutes 25 cycles
8. Durability	Contact resistance No more than 2mΩ	30 mating/unmating cycles
9. Solder heat resistance	There should be no melting of the resin part which will influence the performance.	Flow : 260°C, 10sec Hand soldering : temperature of soldering iron at 350°C±10°C for 5 seconds

Note 1 : This is the maximum current rating while all pins are powered or used as all power lines. If you split the current over multiple lines, please factor in your own safety margin.

Note 2 : Includes the temperature rise of power lines.

Note 3 : The storage condition refers to long-term storage of the product on the shelf before assembly. Please use the operating temperature for temporary storage such as pre-assembly and during shipping.

Materials / Finish

Component	Part	Material	Finish	UL Specification
Header	Insulator	PBT (glass-reinforced)	Black	UL94V-0
	Contact	High conductivity copper alloy	Gold plating	—
	Metal fitting	Brass	Tin-plating	—
Crimp socket	Insulator	PBT (glass-reinforced)	Black	UL94V-0
In-line plug	Insulator	PBT (glass-reinforced)	Black	UL94V-0
Crimp contact	Contact	High conductivity copper alloy	Gold plating	—

Product Number Structure

Refer to the chart below when determining the product specifications from the product number.
Please select from the product numbers listed in this catalog when placing orders.

Header Connector

DF **60** **F** **R** - ***** **P** - **10.16** **DSA**

① ② ③ ④ ⑤ ⑥ ⑦ ⑧

① Series Name : DF	⑤ Number of contacts : 1, 2, 3, 4, 5, 6
② Series No. : 60	⑥ Connector type P : Pin header
③ Form type Blank : Standard F : Finger-safe	⑦ Pitch : 10.16mm
④ Guide key type Blank : Standard R : Another key shape	⑧ Type of housing DSA : Straight pin header DS : Right angle pin header

Socket Connector

DF **60** **F** **R** - ***** **S** - **10.16** **C**

① ② ③ ④ ⑤ ⑥ ⑦ ⑧

① Series Name : DF	⑤ Number of contacts : 1, 2, 3, 4, 5, 6
② Series No. : 60	⑥ Connector type S : Socket
③ Form type A : Standard F : Finger-safe	⑦ Pitch : 10.16mm
④ Guide key type Blank : Standard R : Another key shape	⑧ Type of housing C : Crimp socket

In-line plug Connector

DF **60** **F** **R** - ***** **EP** - **10.16** **C**

① ② ③ ④ ⑤ ⑥ ⑦ ⑧

① Series Name : DF	⑤ Number of contacts : 1, 2, 3, 4, 5
② Series No. : 60	⑥ Connector type EP : In-line plug
③ Form type Blank : Standard A : No flange F : Finger-safe	⑦ Pitch : 10.16mm
④ Guide key type Blank : Standard R : Another key shape	⑧ Type of housing C : Crimp socket

Crimp Contact

DF **60** **A** - **8** **SCFA**

① ② ③

① Type of connection Blank : Standard A : Sequential	③ Packaging styles SCFA : Socket contact / reel SCA : Socket contact / loose PCFA : In-line plug contact / reel PCA : In-line plug contact / loose
② Applicable wire size 8 : 8 AWG 1012 : 10 to 12 AWG	

■ Diagram of Connector Mating Combinations

● Standard Type

Crimp socket	Socket contact
DF60A(R)-*S-10.16C (Note)	DF60-*SC(F)A

Note : R type (Another key shape) socket mates with R type plug / pin header.

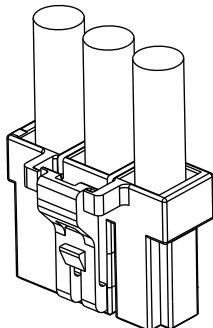

Straight pin header
DF60(R)-*P-10.16DSA

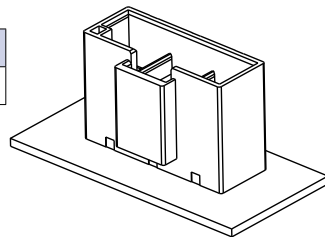

Right angle pin header
DF60(R)-*P-10.16DS

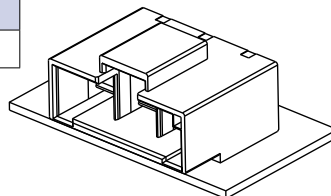

In-line plug	In-line plug contact
DF60(A)(R)-*EP-10.16C	DF60(A)-*PC(F)A

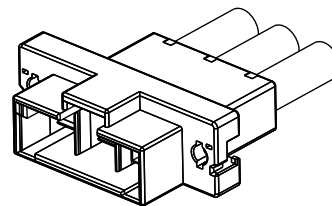

● Finger-safe Type

Crimp socket	Socket contact
DF60F(R)-*S-10.16C (Note)	DF60-*SC(F)A

Note : R type (Another key shape) socket mates with R type plug / pin header.

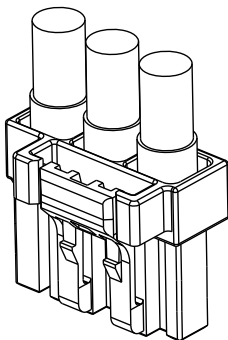

Straight pin header
DF60F(R)-*P-10.16DSA

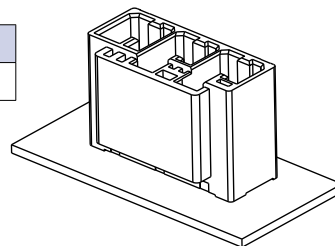

In-line plug	In-line plug contact
DF60F(R)-*EP-10.16C	DF60(A)-*PC(F)A

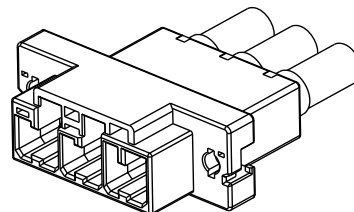

■ Straight pin header



PCB layout

(Recommended thickness of PCB: $t=1.6\pm0.1\text{mm}$)

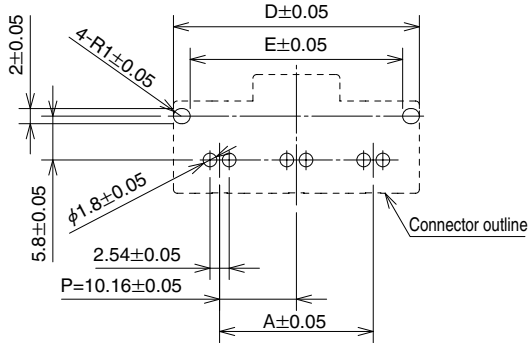

Headers with 1 to 4 pos.

Headers with 5 to 6 pos.

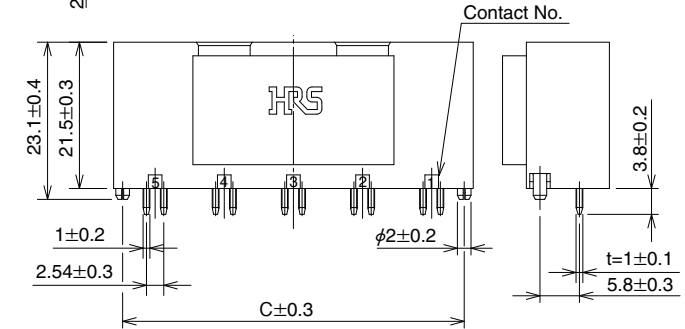
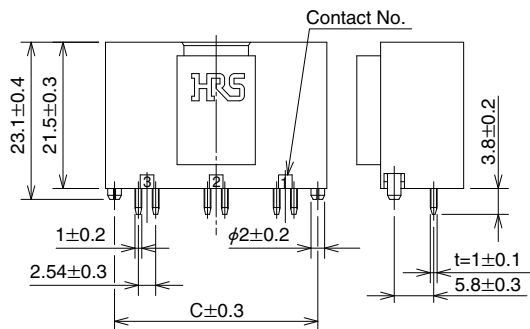
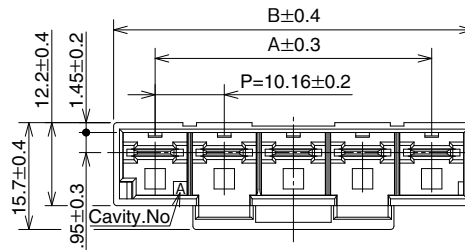
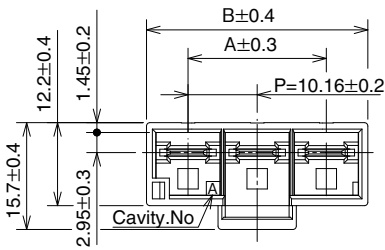

gold plating, tray packaging

Standard Type

Unit : mm

Part No.	HRS No.	No. of Contacts	A	B	C	D	E	Quantity per package	Guide key	Color
DF60-1P-10.16DSA(27)	680-3004-5 27	1	—	15.2	9.55	12.2	7.78	160	Standard	Black
DF60-2P-10.16DSA(27)	680-3005-8 27	2	10.16	22.36	19.71	22.36	17.94	96		
DF60-3P-10.16DSA(27)	680-3001-7 27	3	20.32	32.52	29.87	32.52	28.1	64		
DF60-4P-10.16DSA(27)	680-3006-0 27	4	30.48	42.68	40.03	42.68	38.26	48		
DF60-5P-10.16DSA(27)	680-3007-3 27	5	40.64	52.84	50.19	52.84	48.42	32		
DF60-6P-10.16DSA(27)	680-3008-6 27	6	50.8	63	60.35	63	58.58			

Standard Type [Color : Red]

Part No.	HRS No.	No. of Contacts	A	B	C	D	E	Quantity per package	Guide key	Color
DF60-2P-10.16DSA(45)	680-3005-8 45	2	10.16	22.36	19.71	22.36	17.94	96	Standard	Red
DF60-3P-10.16DSA(45)	680-3001-7 45	3	20.32	32.52	29.87	32.52	28.1	64		

R Type

Part No.	HRS No.	No. of Contacts	A	B	C	D	E	Quantity per package	Guide key	Color
DF60R-3P-10.16DSA(27)	680-3038-7 27	3	20.32	32.52	29.87	32.52	28.1	64	Another key shape	Gray

Note : Please place orders in full lot quantities.

Right angle pin header

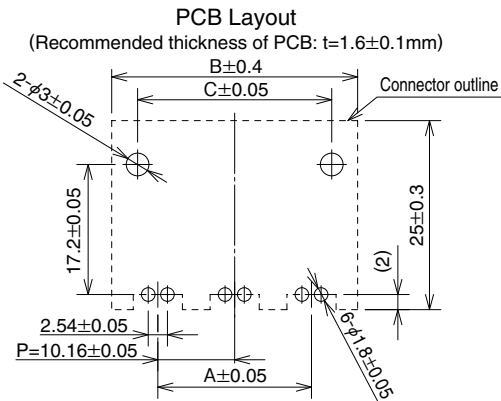

Headers with 1 to 4 pos.

Headers with 5 to 6 pos.

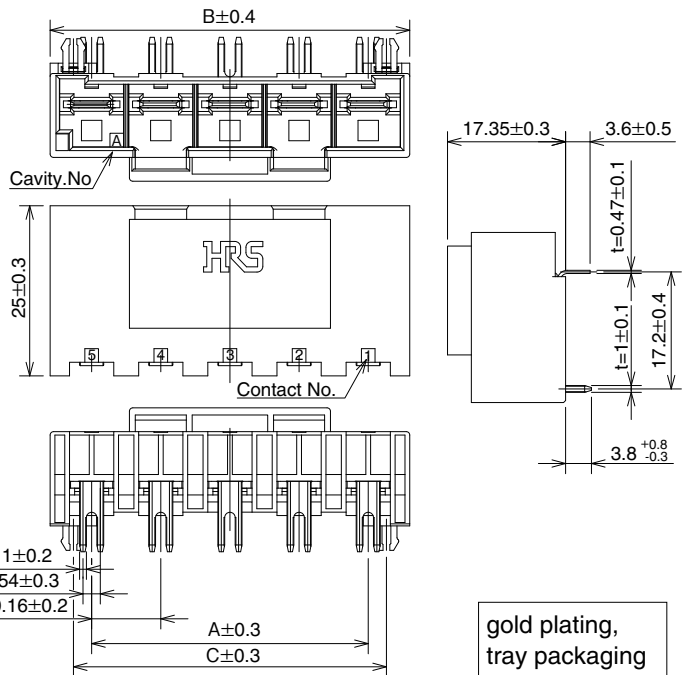
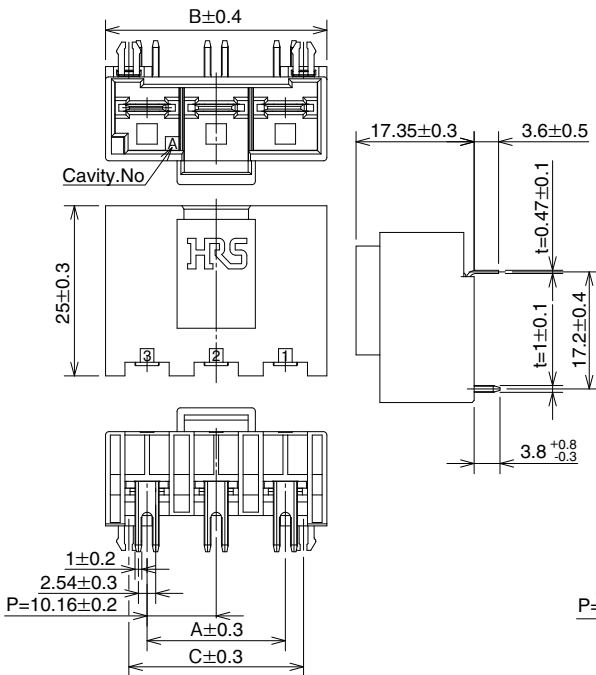

gold plating,
tray packaging

Standard Type

Part No.	HRS No.	No. of Contacts	A	B	C	Quantity per package	Guide key	Color
DF60-1P-10.16DS(27)	680-3015-1 27	1	—	15.2	8.35	120	Standard	Black
DF60-2P-10.16DS(27)	680-3016-4 27	2	10.16	22.36	15.51	72		
DF60-3P-10.16DS(27)	680-3017-7 27	3	20.32	32.52	25.67	48		
DF60-4P-10.16DS(27)	680-3018-0 27	4	30.48	42.68	35.83	36		
DF60-5P-10.16DS(27)	680-3019-2 27	5	40.64	52.84	45.99	24		
DF60-6P-10.16DS(27)	680-3020-1 27	6	50.8	63	56.15			

Unit : mm

Standard Type [Color : Red]

Part No.	HRS No.	No. of Contacts	A	B	C	Quantity per package	Guide key	Color
DF60-2P-10.16DS(45)	680-3016-4 45	2	10.16	22.36	15.51	72	Standard	Red

R Type

Part No.	HRS No.	No. of Contacts	A	B	C	Quantity per package	Guide key	Color
DF60R-2P-10.16DS(27)	680-3043-7 27	2	10.16	22.36	15.51	72	Another key shape	Gray
DF60R-3P-10.16DS(27)	680-3044-0 27	3	20.32	32.52	25.67	48		

Note : Please place orders in full lot quantities.

In-line plug



The torque value for attaching screws is 49N
Panel cutout

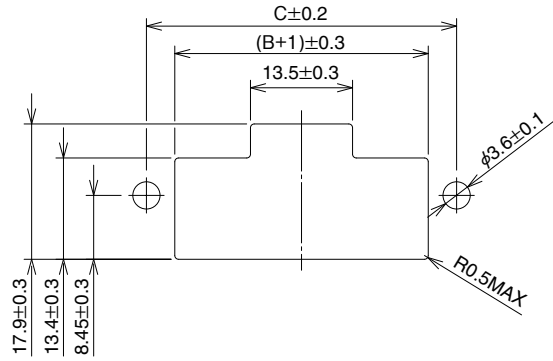

In-line plugs with 1 to 5 pos.

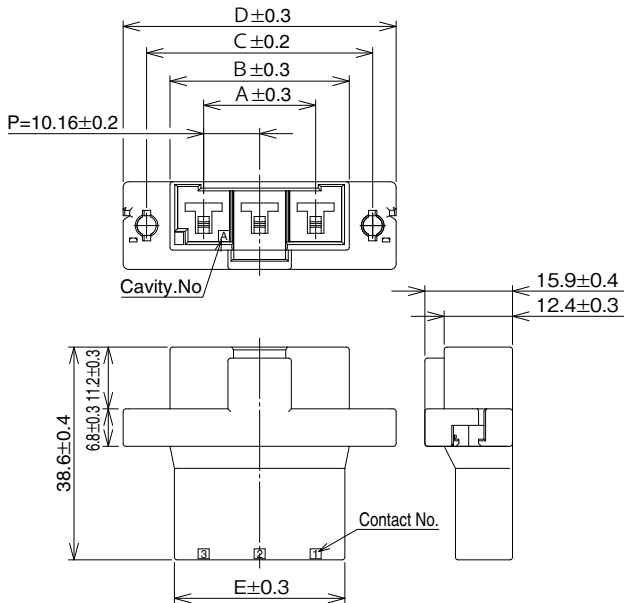

In-line plug with 4 pos.

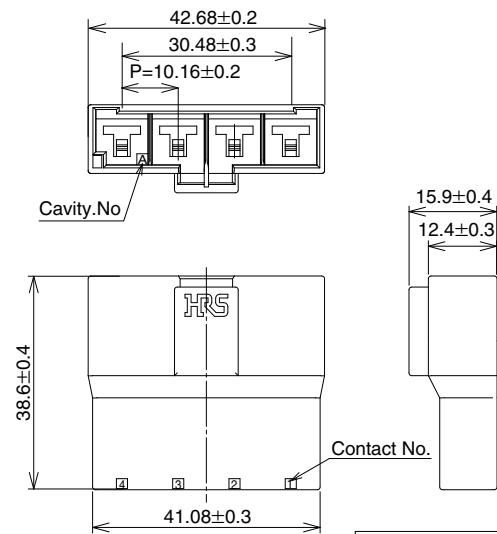

1 package = 100 pcs

Standard Type

Unit : mm

Part No.	HRS No.	No. of Contacts	A	B	C	D	E	Guide key	Color
DF60-1EP-10.16C	680-3050-2	1	—	15.2	23.7	32.2	10.6	Standard	Black
DF60-2EP-10.16C	680-3025-5	2	—	22.36	30.86	39.36	20.76		
DF60-3EP-10.16C	680-3026-8	3	20.32	32.52	41.02	49.52	30.92		
DF60-4EP-10.16C	680-3027-0	4	30.48	42.68	51.18	59.68	41.08		
DF60-5EP-10.16C	680-3028-3	5	40.64	52.84	61.34	69.84	51.24		

Standard Type [Color : Red]

Part No.	HRS No.	No. of Contacts	A	B	C	D	E	Guide key	Color
DF60-1EP-10.16C(15)	680-3050-2 15	1	—	15.2	23.7	32.2	10.6	Standard	Red
DF60-2EP-10.16C(15)	680-3025-5 15	2	—	22.36	30.86	39.36	20.76		
DF60-3EP-10.16C(15)	680-3026-8 15	3	20.32	32.52	41.02	49.52	30.92		

R Type

Part No.	HRS No.	No. of Contacts	A	B	C	D	E	Guide key	Color
DF60R-2EP-10.16C	680-3053-0	2	—	22.36	30.86	39.36	20.76	Another key shape	Gray
DF60R-3EP-10.16C	680-3054-0	3	20.32	32.52	41.02	49.52	30.92		

No Flange Type

Part No.	HRS No.	No. of Contacts	Guide key	Color
DF60A-4EP-10.16C	680-3069-0	4	Standard	Black

Note : Bag packaging (100pcs/pack). Order by number of packs.

■ Crimp socket



Crimp socket with 1 to 4 pos.

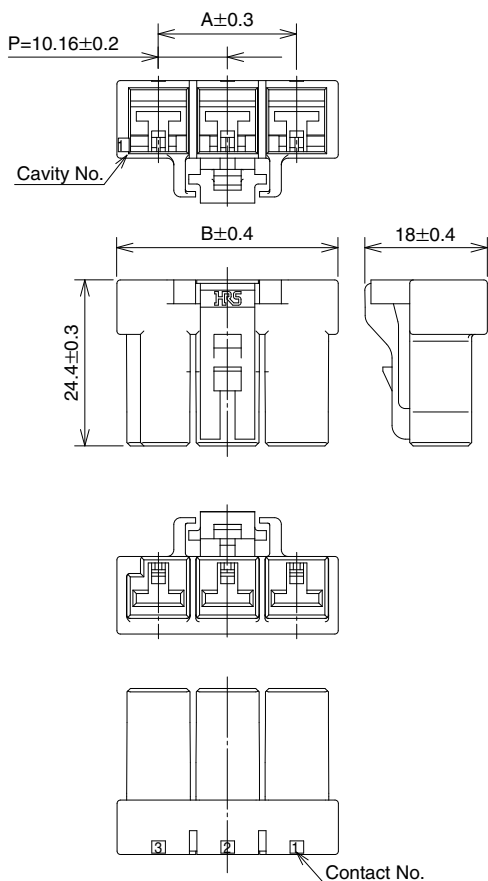

Crimp socket with 5 to 6 pos.

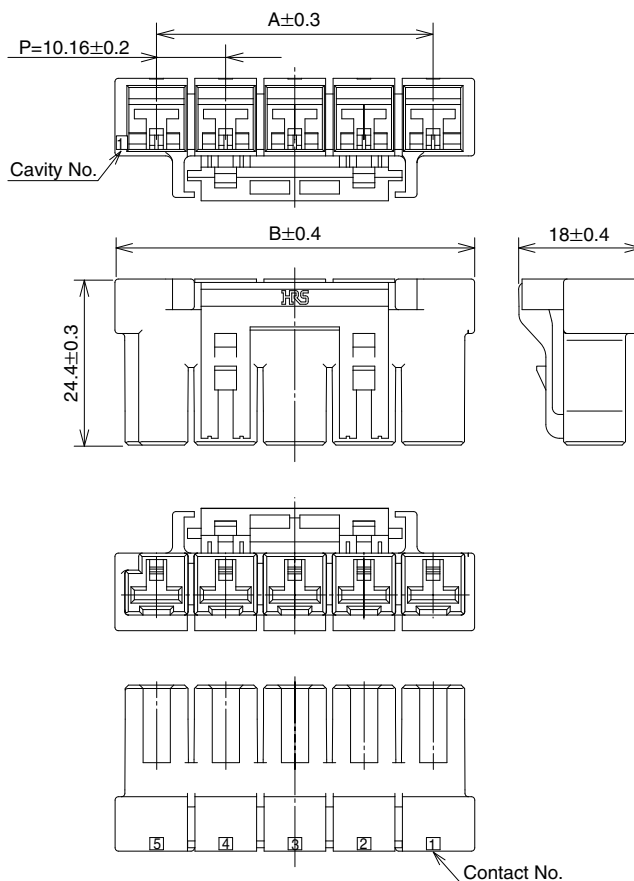

1 package = 100 pcs

Standard Type

Unit : mm

Part No.	HRS No.	No. of Contacts	A	B	Guide key	Color
DF60A-1S-10.16C	680-3058-0	1	—	15.8	Standard	Black
DF60A-2S-10.16C	680-3059-0	2	10.16	22.36		
DF60A-3S-10.16C	680-3060-0	3	20.32	32.52		
DF60A-4S-10.16C	680-3061-0	4	30.48	42.68		
DF60A-5S-10.16C	680-3076-0	5	40.64	52.84		
DF60A-6S-10.16C	680-3077-0	6	50.8	63.0		

Standard Type [Color : Red]

Part No.	HRS No.	No. of Contacts	A	B	Guide key	Color
DF60A-1S-10.16C(15)	680-3058-0 15	1	—	15.8	Standard	Red
DF60A-2S-10.16C(15)	680-3059-0 15	2	10.16	22.36		
DF60A-3S-10.16C(15)	680-3060-0 15	3	20.32	32.52		

R Type

Part No.	HRS No.	No. of Contacts	A	B	Guide key	Color
DF60AR-2S-10.16C	680-3063-0	2	10.16	22.36	Another key shape	Gray
DF60AR-3S-10.16C	680-3064-0	3	20.32	32.52		

Note : Bag packaging (100pcs/pack). Order by number of packs.

■ Straight pin header (Finger-safe Type)

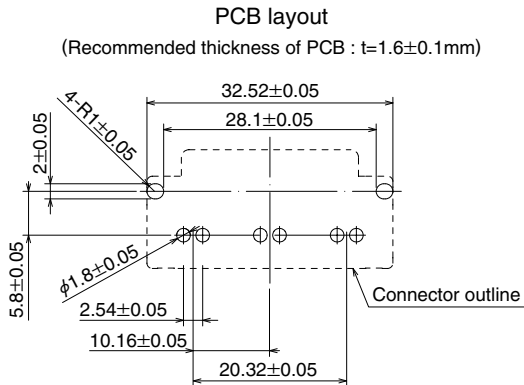
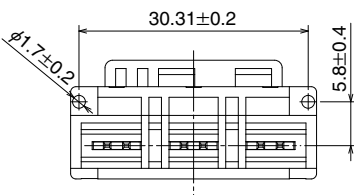
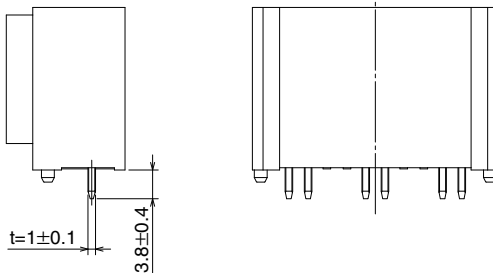
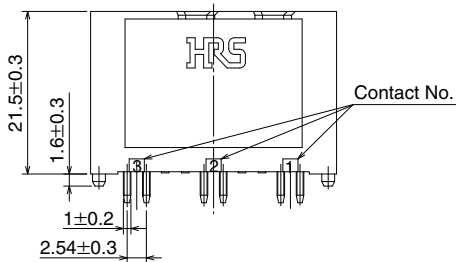
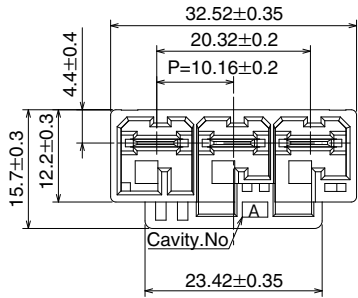
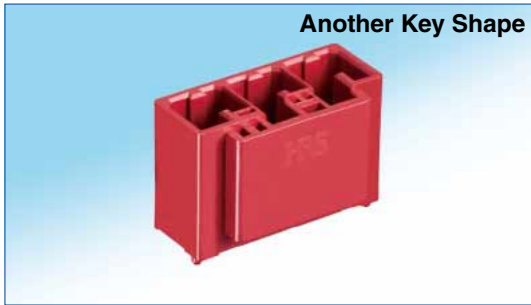

Part No.	HRS No.	No. of Contacts	Quantity per package	Guide key	Color
DF60F-3P-10.16DSA(50)	680-4001-0 50	3	64	Standard	Black
DF60FR-3P-10.16DSA(50)	680-4004-0 50	3	64	Another key shape	Red

Note : Please place orders in full lot quantities.

In-line plug (Finger-safe Type)

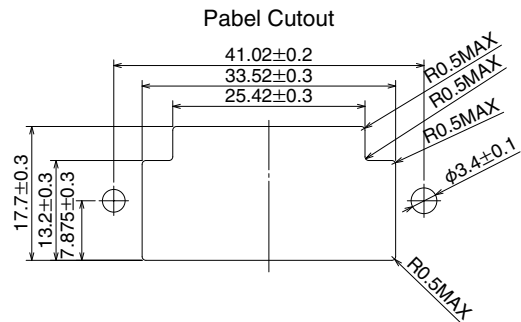
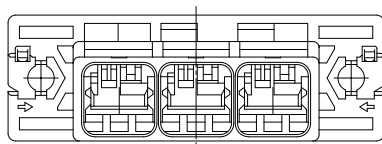
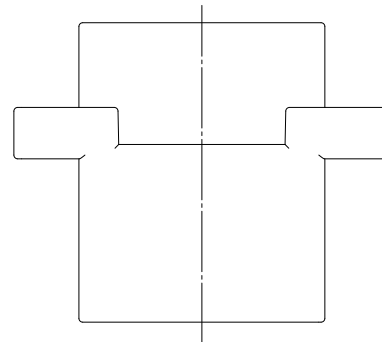
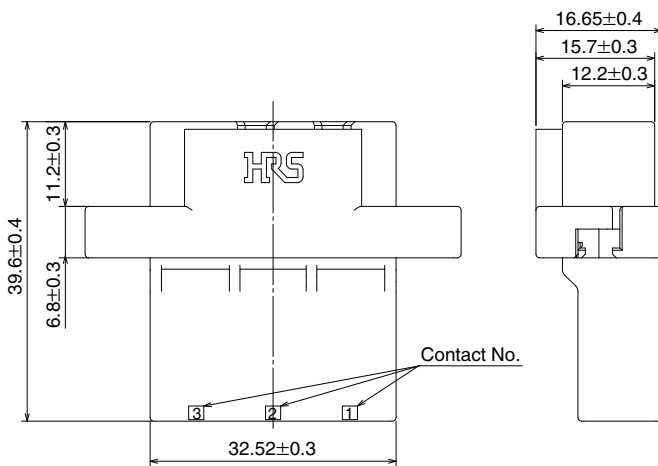
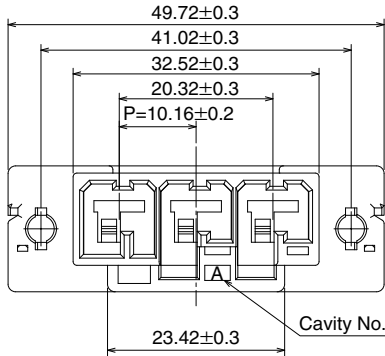
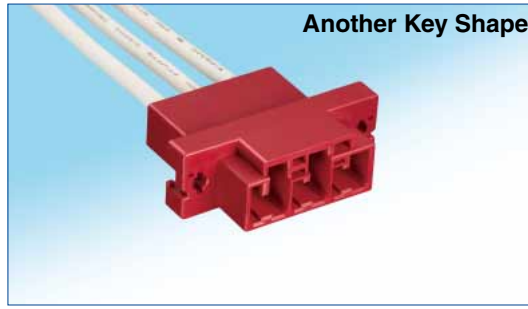

Part No.	HRS No.	No. of Contacts	Quantity per package	Guide key	Color
DF60F-3EP-10.16C	680-4003-0	3	100	Standard	Black
DF60FR-3EP-10.16C	680-4006-0	3	100	Another key shape	Red

Note 1 : Bag packaging (100pcs/pack). Order by number of packs.

Note 2 : For better finger-safe function, heat shrink tube shall be installed to Crimp contact of in-line plug.

(Recommended heat shrink tube : Sumitomo Electric Industries, Ltd. F2(Z)8×0.25)

For the details, please see DF60 Cable Assembly procedure. (ETAD-H0653)

■ Crimp socket (Finger-safe Type)

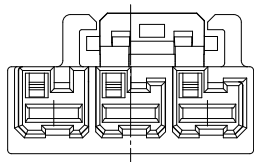
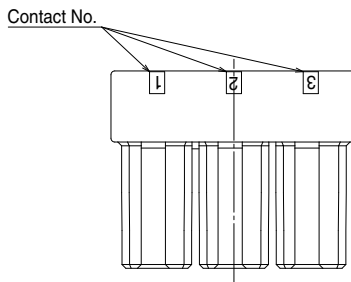
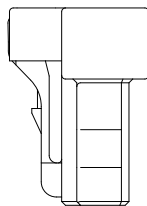
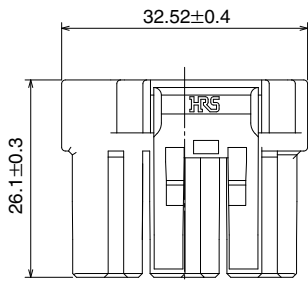
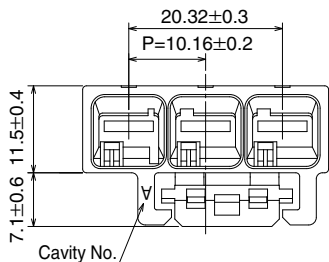

Part No.	HRS No.	No. of Contacts	Quantity per package	Guide key	Color
DF60F-3S-10.16C	680-4002-0	3	100	Standard	Black
DF60FR-3S-10.16C	680-4005-0	3	100	Another Key shape	Red

Note 1 : Bag packaging (100pcs/pack). Order by number of packs.

Note 2 : For better finger-safe function, heat shrink tube shall be installed to Crimp contact of socket.

(Recommended heat shrink tube : Sumitomo Electric Industries, Ltd. F2(Z)8×0.25)

For the details, please see DF60 Cable Assembly procedure. (ETAD-H0653)

■ Socket crimp contact

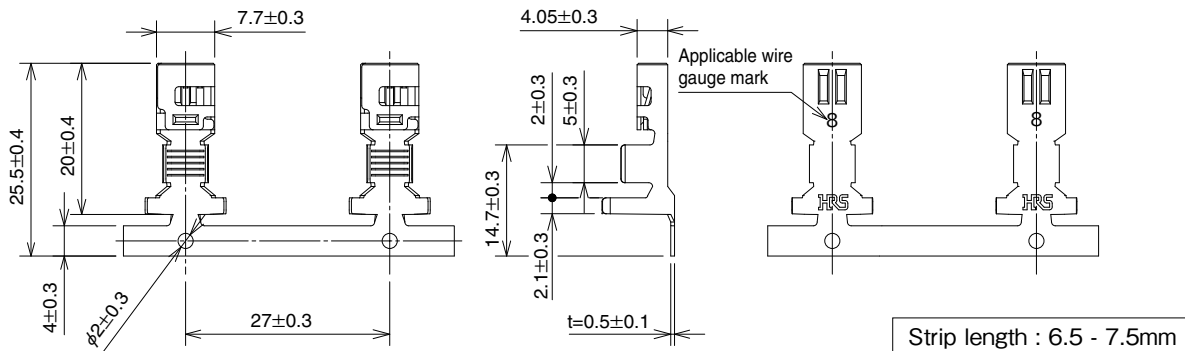

Part No.	HRS No.	Applicable wires					
		UL	Jacket Diameter	Wire size	Core structure	Package style	Quantity
DF60-8SCFA	680-3003-2	UL1283	4.9 to 7.8	8 AWG	7/24/0.26	Reel	700
DF60-8SCA	680-3021-4		7.54			Loose	100
DF60-1012SCFA	680-3014-9	UL1015	4 to 5.2	10 AWG	104/0.26	Reel	900
				12 AWG	65/0.26		
DF60-1012SCA	680-3022-7	UL1015	4.69	10 AWG	104/0.26	Loose	100
			4.04	12 AWG	65/0.26		

Note 1 : The applicable wires are tin-plated and annealed.

Note 2 : Please contact our Sales Department when using wires other than those listed.

■ Crimp contact for in-line plugs

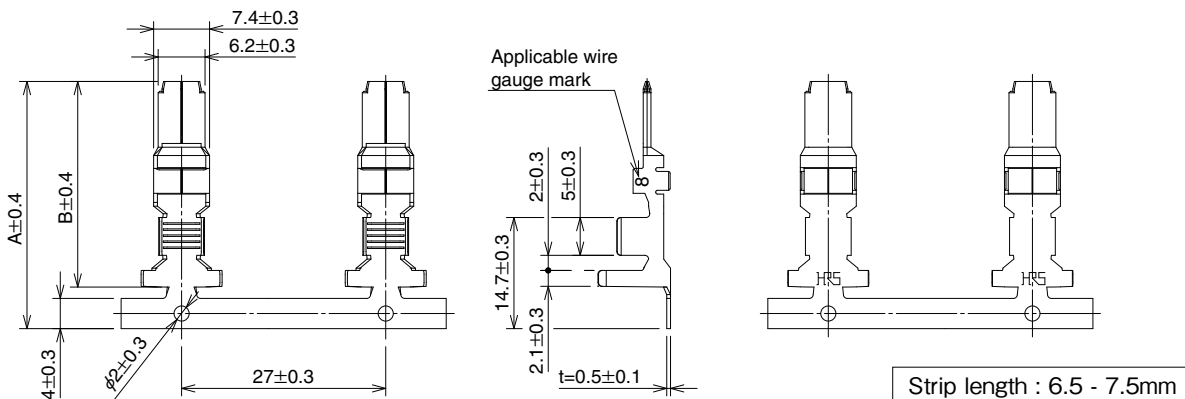

Part No.	HRS No.	A	B	Applicable wires					
				UL	Jacket Diameter	Wire size	Core structure	Package style	Quantity
DF60A-8PCFA (Note 3)	680-3057-0	34.2	28.7	UL1283	4.9 to 7.8	8 AWG	7/24/0.26	Reel	700
DF60-8PCFA(07)	680-3023-0 07	32.7	27.2		7.54			Loose	100
DF60-8PCA(07)	680-3048-0 07			UL1015	4 to 5.2	10 AWG	104/0.26	Reel	900
DF60-1012PCFA(07)	680-3024-2 07	32.7	27.2			12 AWG	65/0.26		
DF60-1012PCA(07)	680-3049-3 07	32.7	27.2	UL1015	4.69	10 AWG	104/0.26	Loose	100
					4.04	12 AWG	65/0.26		

Note 1 : The applicable wires are tin-plated and annealed.

Note 2 : Please contact our Sales Department when using wires other than those listed.

Note 3 : Not conforming to finger-safe type.

◆ Applicable crimping tool

Item	Part No.	HRS No.	Applicable contact	Remarks
Applicator	AP105-DF60-8	901-4623-5	DF60-8SCFA(##)/PCFA(##)	(Note 4) manufactured by Japan Automatic Machine Co., Ltd.
	QHS895700H-UP	-	DF60A-8PCFA	
	AP105-DF60-1012	901-4624-8	DF60-1012SCFA(##)/PCFA(##)	(Note 4) manufactured by Japan Automatic Machine Co., Ltd.
	QHS888000K-UP	-		
Hand tool	HT306/DF60-8	550-0301-4	DF60-8SCA/PCA *Exclusive for UL1283 8AWG	
	HT306/DF60-1012	550-0307-0	DF60-1012SCA/PCA *Exclusive for UL1015 10 to 12AWG	

Note 1 : Please use a press machine which can mount HIROSE genuine applicator and the working load shall be more than 3 ton.

Note 2 : Please contact our Sales Department when you are using crimp tools made by other manufacturers.

Note 3 : Please do the crimping operations according to the "Crimping work standards" and "Crimping condition table".

Note 4 : Please contact Japan Automatic Machine Co., Ltd. (hereinafter J.A.M.) through their website regarding crimping issues when using applicators manufactured by J.A.M. URL <http://www.jam-net.co.jp>

◆ **Mated dimensions**

● **Wire-to-Board Connection using the straight pin header**

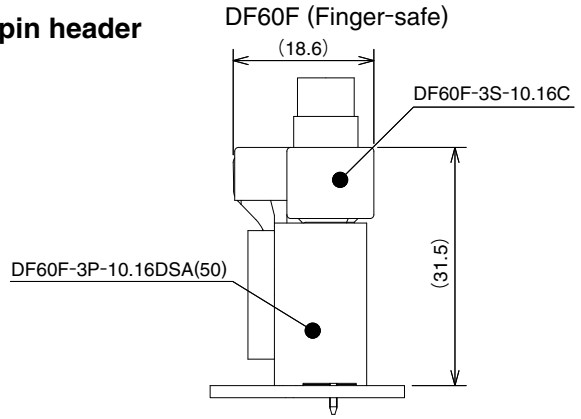
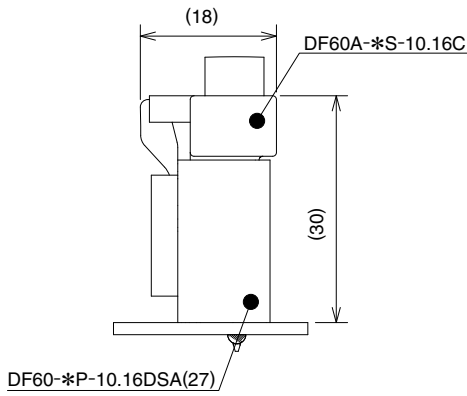

● **Wire-to-Board Connection using the right angle pin header.**

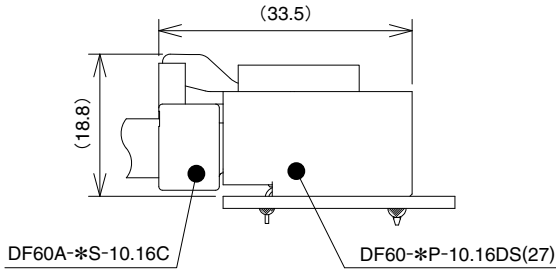

● **In-line or Wire-to-Wire Connection**

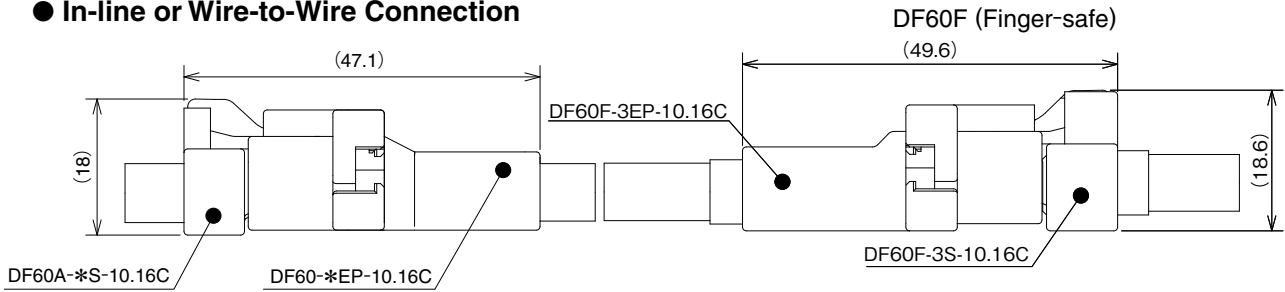

◆ **Usage example of sequential contacts**

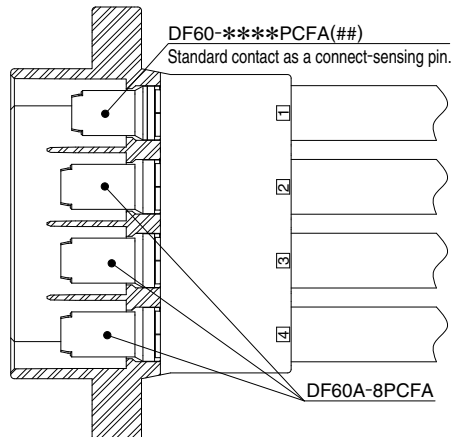
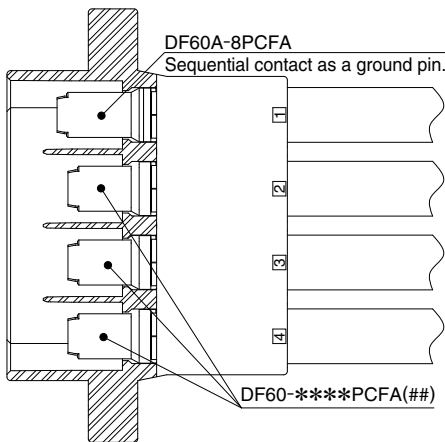

◆ Removing Contacts

- Contact extraction tool: precision screwdriver (flathead screwdriver with 1.4mm in width across flats)
- For Crimp contacts: DF60-8SC(F)A, DF60-1012SC(F)A, DF60-8PC(F)A, DF60-1012PC(F)A
- Procedure

Sectioned drawing of the housing

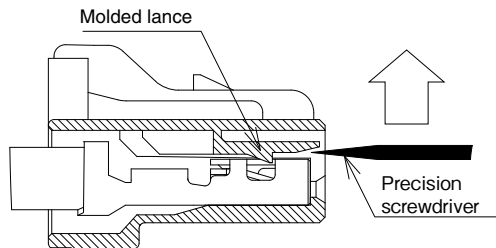

1. After unmating the parts, position the screwdriver to raise the lance as shown in the illustration.

Before attempting to remove any contacts, make sure that the power is switched off and the system is de-energized.

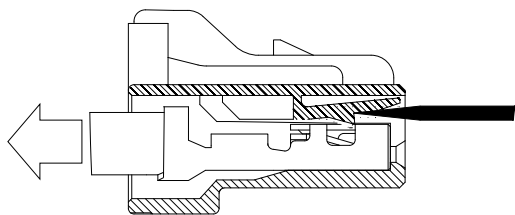

2. The lance needs to be raised sufficiently to allow the terminated wire to slip past it. The lance needs to be held up while at the same time pulling on the wire.

Due to any previous repairs, the strength of the lance could have been compromised. Hirose recommends the use of a new crimp housing to assure proper performance.

Caution

Please be very careful when removing the contact work so that you don't become injured by the protruding part of the crimp contact.

◆ Rated values

Please avoid using the device above the rated values. Also, do not insert or pull out energized or "live" wires.

◆ Operating environment

Please contact us if you are designing this connector into environmental conditions where high and low temperatures are repeated.

◆Precautionary notes

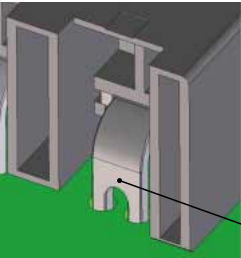
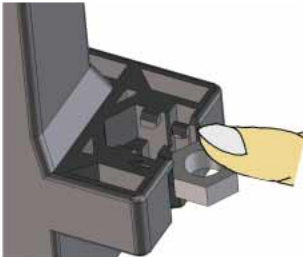
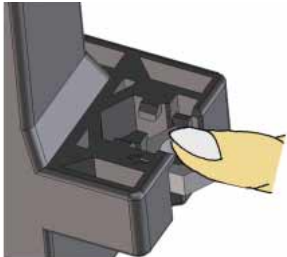
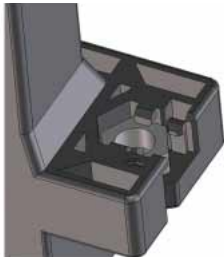
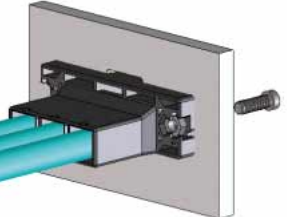
<p>1. Recommended soldering conditions</p>	<ul style="list-style-type: none"> ■ Soldering profile when using an automatic soldering device Soldering temperature: 260°C ; Soldering time: no more than 10 seconds ■ Hand soldering conditions Temperature of soldering iron: 350±10°C , soldering time: no more than 3 seconds
<p>2. Cleaning Conditions</p>	<p>Please refer to the "Wire-to-Board Connector Guide". Cleaning with IPA is allowed. (Other cleaning agents are not recommended due to the fact that it may change the push/pull feeling. Please contact us when you use other cleaning agents.)</p>
<p>3. Important notes</p>	<ol style="list-style-type: none"> 1. Caution is required for mating and un-mating the connector without it being mounting on a PCB. Doing so can damage or deform the contacts. 2. During hand soldering, do not apply excess amounts flux which can migrate on to the connector. 3. This product may have a slight differences in color depending on the production lot. This difference does not have any influence on the performance. 4. The connector could be damaged if it is pulled out forcibly. When it is hard to pull out, push it in slightly first and then depress the lock and un- mate. Please refer to "DF60 Series mating and unmating Procedure Document (ETAD-H0654-00)" for points in handling regarding mating operations. 5. When thick, short sections of wire are used, the connector could be deformed due to the force of the wires' position. Route cables in such a way that they do not twist when being installed. 6. Make sure to turn off the power when mating or un-mating the connector. 7. Please do not touch any area around the contact part with your hand when the power is on; it could be very dangerous. 8. Please refer to "Harness procedure manual (ETAD-H0653-00)" for points in harness operations.
<p>4. Handling instructions</p>	<p>Please refer to the "Wire-to-Board Connector Guide".</p>
<p>5. Right angle pin header Precautions for use</p>	<div style="display: flex; align-items: center;">  <div style="margin-left: 10px;"> <p>Since the lead mounting part has some exposed parts, please insure sufficient clearance when mounting other parts near this connector.</p> <p style="margin-left: 20px;">Lead part</p> </div> </div>
<p>6. In-line connector Panel fixing operation</p>	<div style="display: flex; flex-wrap: wrap;"> <div style="width: 50%;"> <p>① Insert a M3 nut from the lateral direction.</p>  </div> <div style="width: 50%;"> <p>② Push the nut in the direction of the arrow.</p>  </div> <div style="width: 50%;"> <p>③ Nut insertion is then complete.</p>  </div> <div style="width: 50%;"> <p>④ Panel mounting is completed by installing a connector on the panel cutout hole and tightening with a M3 screw. Torque value is 49N-cm max.</p>  </div> </div>

Jul.1.2020 Copyright 2020 HIROSE ELECTRIC CO., LTD. All Rights Reserved.

USA:

HIROSE ELECTRIC (U.S.A.), INC. HEADQUARTERS CHICAGO OFFICE
2300 Warrenville Road, Suite 150,
Downers Grove, IL 60515
Phone : +1-630-282-6700
<http://www.hirose.com/us/>

USA:

HIROSE ELECTRIC (U.S.A.), INC. SAN JOSE OFFICE
2841 Junction Ave, Suite 200
San Jose, CA. 95134
Phone : +1-408-253-9640
Fax : +1-408-253-9641
<http://www.hirose.com/us/>

USA:

HIROSE ELECTRIC (U.S.A.), INC. DETROIT OFFICE (AUTOMOTIVE)
17197 N. Laurel Park Drive, Suite 253,
Livonia, MI 48152
Phone : +1-734-542-9963
Fax : +1-734-542-9964
<http://www.hirose.com/us/>

USA:

HIROSE ELECTRIC (U.S.A.), INC. BOSTON OFFICE
300 Brickstone Square Suite 201,
Andover, MA 01810
Phone : +1-978-662-5255

THE NETHERLANDS:

HIROSE ELECTRIC EUROPE B.V.
Hogehillweg #8 1101 CC Amsterdam Z-0
Phone : +31-20-6557460
Fax : +31-20-6557469
<http://www.hirose.com/eu/>

GERMANY:

HIROSE ELECTRIC EUROPE B.V. GERMAN BRANCH
Schoenbergstr. 20, 73760 ostfildern
Phone : +49-711-456002-1
Fax : +49-711-456002-299
<http://www.hirose.com/eu/>

GERMANY:

HIROSE ELECTRIC EUROPE B.V. NUREMBERG OFFICE
Neumeyerstrasse 22-26, 90411 Nurnberg
Phone : +49-911 32 68 89 63
Fax : +49-911 32 68 89 69
<http://www.hirose.com/eu/>

GERMANY:

HIROSE ELECTRIC EUROPE B.V. HANOVER OFFICE
Bayernstr. 3, Haus C 30855 Langenhagen, Germany
Phone : +49-511 97 82 61 30
Fax : +49-511 97 82 61 35
<http://www.hirose.com/eu/>

FRANCE:

HIROSE ELECTRIC EUROPE B.V. PARIS OFFICE
130 Avenue Joseph Kessel, Bat E, 78960
Voisins le Bretonneux, France
Phone : +33-1-85764886
Fax : +33-1-85764823
<http://www.hirose.com/eu/>

UNITED KINGDOM:

HIROSE ELECTRIC EUROPE BV (UK BRANCH)
4 Newton Court, Kelvin Drive, Knowlhill,
Milton Keynes, MK5 8NH
Phone : +44-1908 202050
Fax : +44-1908 202058
<http://www.hirose.com/eu/>

CHINA:

HIROSE ELECTRIC (CHINA) CO., LTD. (SHANGHAI, HEADQUARTERS)
18, Enterprise Center Tower 2, 209# Gong He
Road, Jing'an District, Shanghai, CHINA 200070
Phone : +86-21-6391-3355
Fax : +86-21-6391-3335
<http://www.hirose.com/cn/>

CHINA:

HIROSE ELECTRIC (CHINA) CO.,LTD. BEIJING BRANCH
A1001, Ocean International Center, Building 56# East 4th
Ring Middle Road, ChaoYang District, Beijing, 100025
Phone : +86-10-5165-9332
Fax : +86-10-5908-1381
<http://www.hirose.com/cn/>

CHINA:

HIROSE ELECTRIC (CHINA) CO., LTD. SHENZHEN BRANCH
Room 09-13, 19/F, Office Tower Shun Hing Square, Di Wang Commercial Centre,
5002 Shen Nan Dong Road, Shenzhen City, Guangdong Province, 518008
Phone : +86-755-8207-0851
Fax : +86-755-8207-0873
<http://www.hirose.com/cn/>

HONG KONG:

HIROSE ELECTRIC HONGKONG TRADING CO., LTD.
Room 1001, West Wing, Tsim Sha Tsui Centre, 66
Mody Road, Tsim Sha Tsui East, Kowloon, Hong Kong
Phone : +852-2803-5338
Fax : +852-2591-6560
<http://www.hirose.com/hk/>

TAIWAN:

HIROSE ELECTRIC TAIWAN CO., LTD.
103 8F, No.87, Zhengzhou Rd., Taipei
Phone : +886-2-2555-7377
Fax : +886-2-2555-7355
<http://www.hirose.com/tw/>

KOREA:

HIROSE KOREA CO.,LTD.
143, Gongdan 1-daero, Siheung-si,
Gyeonggi-do, 15084, Korea
Phone : +82-31-496-7000
Fax : +82-31-496-7100
<http://www.hirose.co.kr/>

SINGAPORE:

HIROSE ELECTRIC SINGAPORE PTE. LTD.
03, Anson Road, #20-01, Springleaf Tower,
Singapore 079909
Phone : +65-6324-6113
Fax : +65-6324-6123
<http://www.hirose.com/sg/>

INDIA:

HIROSE ELECTRIC SINGAPORE PTE. LTD. DELHI LIAISON OFFICE
Office NO.552, Regus-Green Boulevard, Level5, Tower C,
Sec62, Plot B-9A, Block B, Noida, 201301, Uttar Pradesh, India
Phone : +91-12-660-8018
Fax : +91-120-4804949
<http://www.hirose.com/sg/>

INDIA:

HIROSE ELECTRIC SINGAPORE PTE. LTD. BANGALORE LIAISON OFFICE
Unit No-403, 4th Floor, No-84, Barton Centre, Mahatma
Gandhi (MG) Road, Bangalore 560 001, Karnataka, India
Phone : +91-80-4120 1907
Fax : +91-80-4120 9908
<http://www.hirose.com/sg/>

MALAYSIA:

PENANG REPRESENTATIVE OFFICE
73-3-1, Ideal@The One, Jalan Mahsuri, Bayan
Lepas Penang, 11950, Malaysia
Phone : +604-648-5536
<http://www.hirose.com/sg/>

THAILAND:

BANGKOK OFFICE (REPRESENTATIVE OFFICE)
Unit 4703, 47th FL., 1 Empire Tower, South Sathorn
Road, Yannawa, Sathorn, Bangkok 10120 Thailand
Phone : +66-2-686-1255
Fax : +66-2-686-3433
<http://www.hirose.com/sg/>



HIROSE ELECTRIC CO.,LTD.

2-6-3,Nakagawa Chuoh,Tsuzuki-Ku,Yokohama-Shi 224-8540,JAPAN
TEL: +81-45-620-3526 Fax: +81-45-591-3726
<http://www.hirose.com>
<http://www.hirose-connectors.com>