

## The Special Operation Key Activates a Direct Opening Mechanism to Open the Contacts and Shut Off Control Circuits when Protective Doors Are Opened on Machine Tools or Other Equipment

Note: Contact your sales representative for details on models with safety standard certification.



- Conforms to EN (TÜV) standards corresponding to the CE marking.
- Certified by UL and CSA standards.
- The Switch contact is opened by a direct opening mechanism (NC contacts only) when the protective cover is opened. The EN-certified direct opening mechanism is indicated by  on the Switch.
- Malfunctions and false operation prevented by special Operation Key.
- Wide temperature range specifications: -40 to 80°C.
- Degree of protection of the switch box: IP67 (EN60947-5-1).

 Be sure to read the "Safety Precautions" on page 7.

## Model Number Structure

### Model Number Legend

#### Switch

D4BS -       S

1    2    3

##### 1. Conduit

- 1: PG13.5 (1 conduit)
- 2: G1/2 (1 conduit)
- 4: M20 (1 conduit)

##### 2. Built-in Switch

- 5: 1NC/1NO (slow-action)
- A: 2NC (slow-action)

##### 3. Head Mounting Direction

- F: Four mounting directions possible (front-side mounting at shipping)

#### Operation Key

D4BS - K  

1

##### 1. Operation Key Type

- 1: Horizontal mounting
- 2: Vertical mounting
- 3: Adjustable mounting (Horizontal)

**Note:** An order for the head part or the switch part alone cannot be accepted. (The Operation Key is sold separately.)

## Ordering Information

### List of Models



Switches (Operation Keys are sold separately.)

: Models with certified direct opening contacts.

Consult with your OMRON representative when ordering any models that are not listed in this table.

| Type      | Mounting direction  |   | Conduit size | 1NC/1NO (Slow-action) | 2NC (Slow-action) |
|-----------|---------------------|---|--------------|-----------------------|-------------------|
| 1-conduit | Front-side mounting |  | Pg13.5       | D4BS-15FS             | D4BS-1AFS         |
|           |                     |   | G1/2         | D4BS-25FS             | D4BS-2AFS         |
|           |                     |   | M20          | D4BS-45FS             | D4BS-4AFS         |

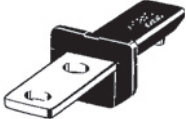
### Operation Keys

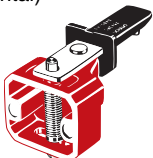
| Type  | Model   |
|---|---------|
| Horizontal mounting<br>              | D4BS-K1 |
| Vertical mounting<br>                | D4BS-K2 |
| Adjustable mounting (Horizontal)<br> | D4BS-K3 |

### Specifications

#### Standards and EC Directives

Conforms to the following EC Directives:

- Machinery Directive
- EN50041
- EN ISO 14119
- EN 60204-1

#### Certified Standards

| Certification body | Standard  | File No.                                       |
|--------------------|---|--|
| TÜV Rheinland      | EN60947-5-1 (certified direct opening) GS-ET-15 | Consult your OMRON representative for details. |
| UL                 | UL508   | E76675   |
| CSA                | CSA C22.2 No. 14                                | LR45746  |
| CQC (CCC)          | GB14048.5                                       | 2003010305073833                               |

#### Certified Standard Ratings

TÜV (EN60947-5-1), CCC (GB14048.5)

| Item                                      | Utilization category | AC-15 |
|---|----------------------|-------|
| Rated operating current (I <sub>e</sub> ) |                      | 2 A   |
| Rated operating voltage (U <sub>e</sub> ) |                      | 400 V |

Note: Use a 10 A fuse type a gI or gG that conforms to IEC60269 as a short-circuit protection device.

#### UL/CSA (UL508, CSA C22.2 No. 14) (A600)

| Rated voltage | Carry current | Current (A) |       | Volt-amperes (VA) |       |
|---------------|---------------|-------------|-------|-------------------|-------|
|               |               | Make        | Break | Make              | Break |
| 120 VAC       | 10 A          | 60          | 6     | 7,200             | 720   |
| 240 VAC       |               | 30          | 3     |                   |       |
| 480 VAC       |               | 15          | 1.5   |                   |       |
| 600 VAC       |               | 12          | 1.2   |                   |       |

## Characteristics

|  |  |   |
|--|--|---|
| <b>Degree of protection *1</b>                                 |  | IP67 (EN60947-5-1)  |
| <b>Durability *2</b>   | <b>Mechanical</b>                              | 1,000,000 operations min.   |
|  | <b>Electrical</b>                              | 500,000 operations min. (10 A resistive load at 250 VAC)  |
| <b>Operating speed</b>   |  | 0.1 m/s to 0.5 m/s  |
| <b>Operating frequency</b>                                     |  | 30 operations/minute max.   |
| <b>Direct opening force *3</b>                                 |  | 19.61 N min. (EN60947-5-1)  |
| <b>Direct opening travel *3</b>                                |  | 20 mm min. (EN60947-5-1)  |
| <b>Contact resistance</b>                                      |  | 25 mΩ max.  |
| <b>Rated insulation voltage (U<sub>i</sub>)</b>                |  | 600 V (EN60947-5-1)   |
| <b>Rated frequency</b>   |  | 50/60 Hz  |
| <b>Protection against electric shock</b>                       |  | Class I (with ground terminal)  |
| <b>Pollution degree (operating environment)</b>                |  | 3 (EN60947-5-1)   |
| <b>Impulse withstand voltage (EN60947-5-1)</b>                 | <b>Between terminals of same polarity</b>      | 4 kV  |
|  | <b>Between terminals of different polarity</b> |   |
|  | <b>Between each terminal and ground</b>        |   |
| <b>Insulation resistance</b>                                   |  | 100 MΩ min. (at 500 VDC) between terminals of same or different polarity, between each terminal and ground, and between each terminal and non-current-carrying metal part |
| <b>Contact gap</b>   |  | 2 × 2 mm min.   |
| <b>Vibration resistance</b>                                    | <b>Malfunction</b>                             | 10 to 55 Hz, 0.65 mm single amplitude   |
|  | <b>Destruction</b>                             | 1,000 m/s <sup>2</sup> min. (IEC68-2-27)  |
| <b>Shock resistance</b>  | <b>Malfunction</b>                             | 300 m/s <sup>2</sup> min. (IEC68-2-27)  |
|  | <b>Conditional short-circuit current</b>       | 100 A (EN60947-5-1)   |
| <b>Conventional enclosed thermal current (I<sub>the</sub>)</b> |  | 20 A (EN60947-5-1)  |
| <b>Ambient operating temperature</b>                           |  | -40 to 80°C (with no icing)   |
| <b>Ambient operating humidity</b>                              |  | 95% max.  |
| <b>Weight</b>  |  | Approx. 285 g (D4BS-15FS)   |

**Note:** The above values are initial values.

\*1. The degree of protection is tested using the method specified by the standard (EN60947-5-1). Confirm that sealing properties are sufficient for the operating conditions and environment beforehand. Although the switch box is protected from dust, oil, or water penetration, do not use the D4BS in places where dust, oil, water, or chemicals may enter through the key hole on the head, otherwise Switch damage or malfunctioning may occur.

\*2. The durability is for an ambient temperature of 5 to 35°C and an ambient humidity of 40% to 70%. Contact your OMRON sales representative for more detailed information on other operating environments.

\*3. These figures are minimum requirements for safe operation.

# Structure and Nomenclature

## Structure

**Operation Key**  
D4BS's exclusive-use Operation Key is provided to assure accurate switching operation.

**Set Zone Mark**  
A triangular Set Zone Mark makes it easy to adjust the operating position when inserting the Operation Key.

**Built-in Switch**  
A shearing force contact separating mechanism (NC contact) is employed, which positively pulls apart the contacts from each other by using shearing force if any abnormality such as contact welding should occur in the contact area.  
There is a difference in level between the NC and NO terminal, which assures easy wiring.

**Ground Terminal Screw**  
A ground terminal is provided to improve safety. (Built into the Unit.)

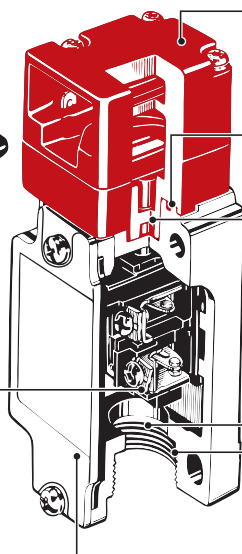
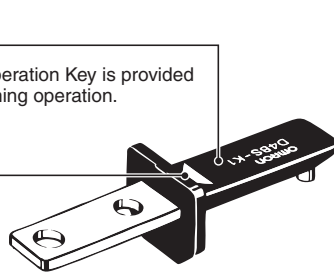

**Head**  
The switch head is coated with easy-to-see red paint. The mounting direction of the switch head can be varied to any of the four directions.

**Seal Ring (NBR)**

**Oil Seal (NBR)**  
The operation plunger employs an oil seal, with which the switch box meets the requirements of IP67.

**Seal Packing (NBR)**

**Conduit Opening**

Refer to the following list.

| Size   | Box | 1-conduit box |
|--------|-----|---------------|
| Pg13.5 |     | Yes           |
| G1/2   |     | Yes           |
| M20    |     | Yes           |

## Contact Form (Diagrams Show State with Key Inserted)

| Model     | Contact form | Operating pattern  | Remarks   |
|-----------|--------------|--|---|
| D4BS-□5FS | 1NC/1NO<br>  | <p>Operation Key insertion completion position      Extraction completion position</p> | <p>Only NC contact 11-12 has a certified direct opening mechanism. (→)</p> <p>Terminals 11-12 and 23-24 can be used as unlike poles.</p>        |
| D4BS-□AFS | 2NC<br>      | <p>Operation Key insertion completion position      Extraction completion position</p> | <p>NC contacts 11-12 and 21-22 have a certified direct opening mechanism. (→)</p> <p>Terminals 11-12 and 21-22 can be used as unlike poles.</p> |

**Note:** The terminal numbers are in accordance with EN50013, and the contact symbols are in accordance with IEC60947-5-1.

# Dimensions and Operating Characteristics

(Unit: mm)

## Switches

### 1-conduit

D4BS-1□FS

D4BS-2□FS

D4BS-4□FS

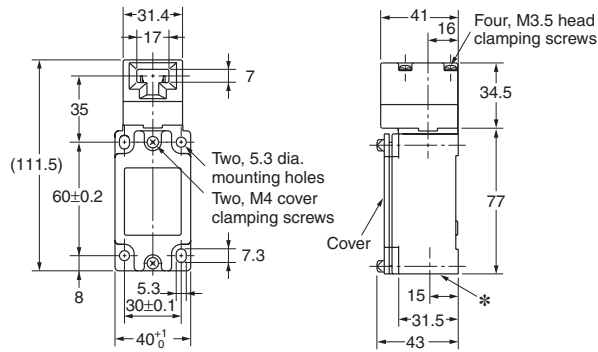
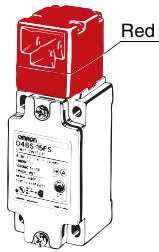

| Operating characteristics | Model | D4BS-1□FS<br>D4BS-2□FS<br>D4BS-4□FS |
|---------------------------|-------|-------------------------------------|
| Key insertion force       |       | 19.61 N max.                        |
| Key extraction force      |       | 19.61 N max.                        |
| Pretravel (PT)            |       | 10±5 mm                             |
| Total travel              |       | 23 mm min.                          |
| Direct opening force      |       | 19.61 N min.                        |
| Direct opening stroke     |       | 20 mm min.                          |

**Note: 1.** Unless otherwise specified, a tolerance of  $\pm 0.4$  mm applies to all dimensions.

**2.** There are fluctuations in the contact ON/OFF timing for 2NC contacts. Confirm performance before application.

\* Conduit size

D4BS-1□FS : Pg 13.5

D4BS-2□FS : G1/2

D4BS-4□FS: M20

Operation Keys

D4BS-K1

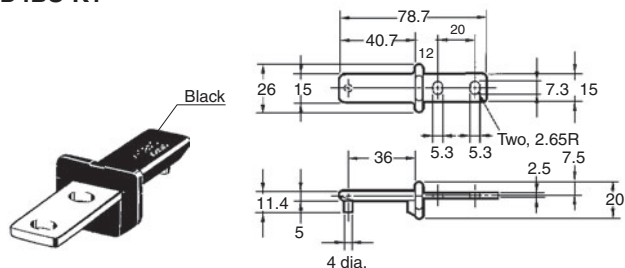

D4BS-K3

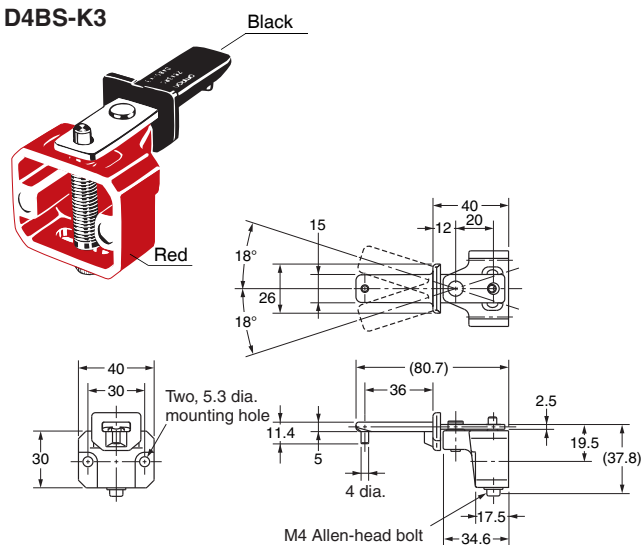

D4BS-K2

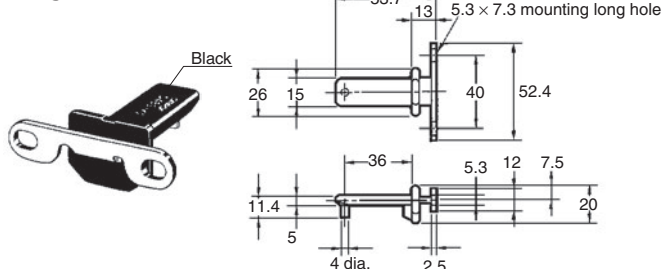

With Operation Key Inserted

D4BS + D4BS-K1

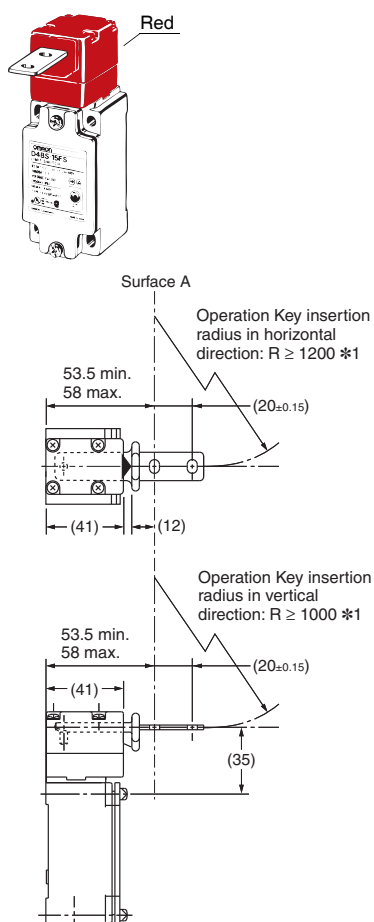

D4BS + D4BS-K2

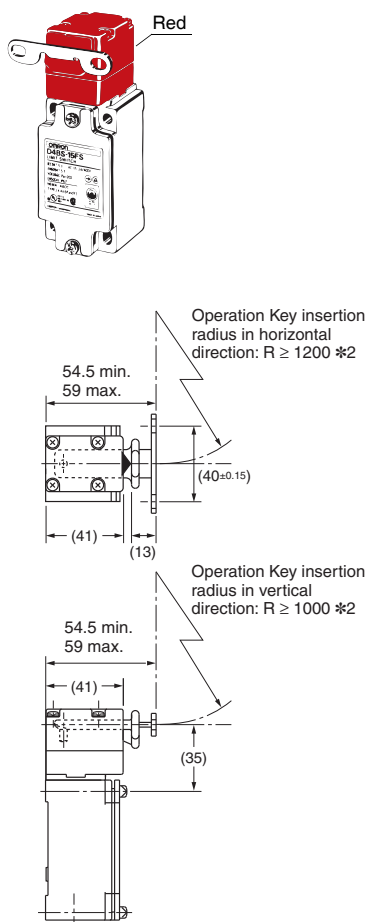

D4BS + D4BS-K3

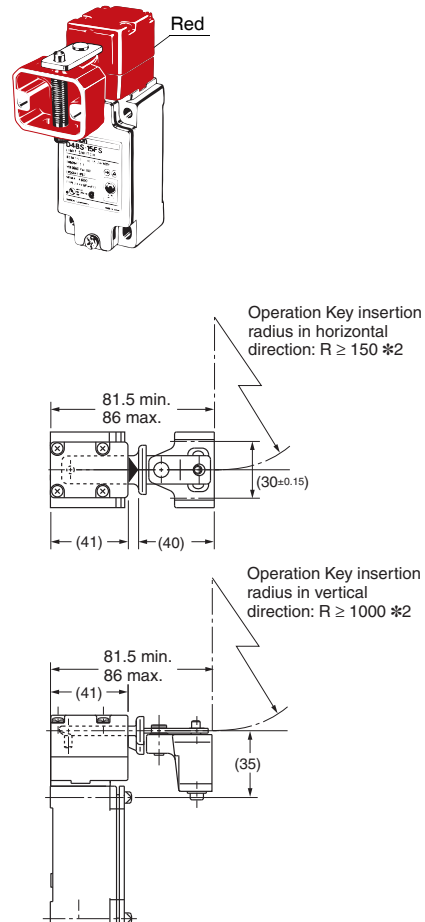

Note: Unless otherwise specified, a tolerance of  $\pm 0.4$  mm applies to all dimensions.

\*1. The insertion radii apply when the rotational center of the Operation Key is on surface A in the figures.

\*2. The insertion radii apply when the rotational center of the Operation Key is on the Operation Key installation surface.

## Safety Precautions

- Be sure to read the precautions for all D4BS models in the website at: <http://www.ia.omron.com/>.

### Precautions for Safe Use

- Do not use the Switch submersed in oil or water or in locations continuously subject to splashes of oil or water. Doing so may result in oil or water entering the Switch. (The IP67 degree of protection of the Switch specifies the amount of water penetration after the Switch is submerged in water for a certain period of time.)
- Always attach the cover after completing wiring and before using the Switch. Also, do not turn ON the Switch with the cover open. Doing so may result in electric shock.

### Stopper Installation

Do not use a Switch as a stopper.

Be sure to install a stopper as shown in the following illustration when mounting the Switch and adjust the stopper so that the Operation Key is within the setting zone.

Do not subject the Switch to a shock that exceeds the Switch's shock resistance of 1,000 m/s<sup>2</sup>.

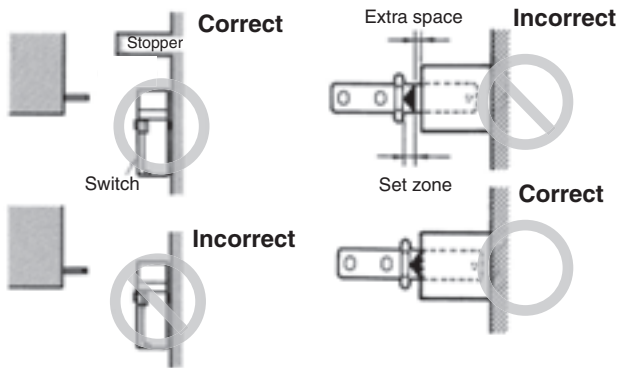

### Precautions for Correct Use

#### Appropriate Tightening Torque

Loose screws may result in malfunction. Tighten the screws to the specified torques.

| Type  | Appropriate tightening torque |
|---|-------------------------------|
| M3.5 terminal screw (including ground terminal screw) | 0.59 to 0.78 N·m              |
| Cover mounting screw                                  | 1.18 to 1.37 N·m              |
| Head mounting screw                                   | 0.78 to 0.98 N·m              |
| M5 body mounting screw *                              | 4.90 to 5.88 N·m              |
| Operation Key mounting screw                          | 2.35 to 2.75 N·m              |
| Connector   | 1.77 to 2.16 N·m              |
| Cap screw   | 1.27 to 1.67 N·m              |

\*Apply a torque of 4.90 to 5.88 N·m for an Allen-head bolt. For a pan head screw, apply a torque of 2.35 to 2.75 N·m.

#### Mounting Dimensions (M5)

##### Standard Model

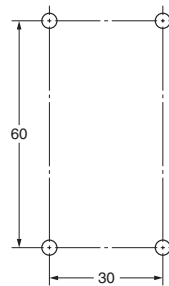

#### Mounting Hole Dimensions for Operation Keys

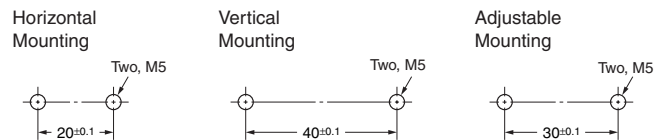

Use spring washers to mount the Switch and Operation key, and tighten the screws to a suitable torque.

To ensure safety, use screws that cannot be easily removed or another means to prevent the Switch and Operation Key from easily being removed.

### Operation Key

Make sure that the Operation Key can be inserted properly with a tolerance of  $\pm 0.5$  mm in the upward, downward, left, or right direction. Otherwise the D4BS may soon become damaged due to misalignment.

Observe the specified insertion radius for the Operation Key and insert it in a direction perpendicular to the key hole. Do not use the D4BL operation key.

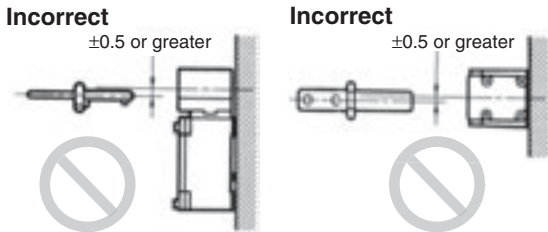

### Changes in Head Mounting Direction

By removing the screws on the four corners of the head, the head can be reset in any of four directions. The head direction can be changed with or without the Operation Key inserted in the head. Make sure that no foreign materials enter through the head and that the head is tightened securely within the proper torque range.

### Wiring

Do not connect the lead wires directly to the terminals. Connect the lead wires through insulation tubes and M3.5 round crimp terminals. Tighten each terminal screw within the proper torque range.

The proper lead wire is AWG20 to AWG14 (0.5 to 2.5 mm<sup>2</sup>) in size.

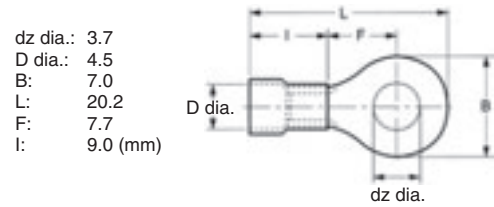

Wire using the methods shown below so that the crimp terminals are not caught on the case or cover. Otherwise it may not be possible to mount the cover completely and malfunctions may occur.

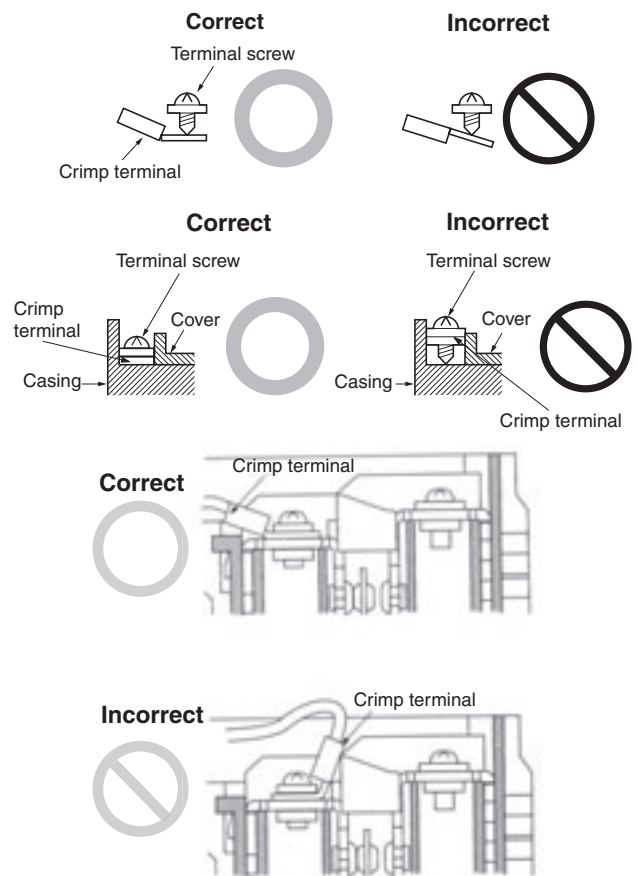

### Conduit Opening

- Tighten the connector to a suitable torque.
- Excessive tightening torque may damage the casing.
- If using a Pg13.5 conduit, use an ABS-08 Pg13.5 connector or an ABS-12 Pg13.5 connector (manufactured by Nippon Flex).
- Use a connector (SC Series, sold separately) suitable for the outer diameter of the cable.



## Terms and Conditions Agreement

### Read and understand this catalog.

Please read and understand this catalog before purchasing the products. Please consult your OMRON representative if you have any questions or comments.

### Warranties.

(a) Exclusive Warranty. Omron's exclusive warranty is that the Products will be free from defects in materials and workmanship for a period of twelve months from the date of sale by Omron (or such other period expressed in writing by Omron). Omron disclaims all other warranties, express or implied.

(b) Limitations. OMRON MAKES NO WARRANTY OR REPRESENTATION, EXPRESS OR IMPLIED, ABOUT NON-INFRINGEMENT, MERCHANTABILITY OR FITNESS FOR A PARTICULAR PURPOSE OF THE PRODUCTS. BUYER ACKNOWLEDGES THAT IT ALONE HAS DETERMINED THAT THE PRODUCTS WILL SUITABLY MEET THE REQUIREMENTS OF THEIR INTENDED USE.

Omron further disclaims all warranties and responsibility of any type for claims or expenses based on infringement by the Products or otherwise of any intellectual property right. (c) Buyer Remedy. Omron's sole obligation hereunder shall be, at Omron's election, to (i) replace (in the form originally shipped with Buyer responsible for labor charges for removal or replacement thereof) the non-complying Product, (ii) repair the non-complying Product, or (iii) repay or credit Buyer an amount equal to the purchase price of the non-complying Product; provided that in no event shall Omron be responsible for warranty, repair, indemnity or any other claims or expenses regarding the Products unless Omron's analysis confirms that the Products were properly handled, stored, installed and maintained and not subject to contamination, abuse, misuse or inappropriate modification. Return of any Products by Buyer must be approved in writing by Omron before shipment. Omron Companies shall not be liable for the suitability or unsuitability or the results from the use of Products in combination with any electrical or electronic components, circuits, system assemblies or any other materials or substances or environments. Any advice, recommendations or information given orally or in writing, are not to be construed as an amendment or addition to the above warranty.

See <http://www.omron.com/global/> or contact your Omron representative for published information.

### Limitation on Liability; Etc.

OMRON COMPANIES SHALL NOT BE LIABLE FOR SPECIAL, INDIRECT, INCIDENTAL, OR CONSEQUENTIAL DAMAGES, LOSS OF PROFITS OR PRODUCTION OR COMMERCIAL LOSS IN ANY WAY CONNECTED WITH THE PRODUCTS, WHETHER SUCH CLAIM IS BASED IN CONTRACT, WARRANTY, NEGLIGENCE OR STRICT LIABILITY.

Further, in no event shall liability of Omron Companies exceed the individual price of the Product on which liability is asserted.

### Suitability of Use.

Omron Companies shall not be responsible for conformity with any standards, codes or regulations which apply to the combination of the Product in the Buyer's application or use of the Product. At Buyer's request, Omron will provide applicable third party certification documents identifying ratings and limitations of use which apply to the Product. This information by itself is not sufficient for a complete determination of the suitability of the Product in combination with the end product, machine, system, or other application or use. Buyer shall be solely responsible for determining appropriateness of the particular Product with respect to Buyer's application, product or system. Buyer shall take application responsibility in all cases.

NEVER USE THE PRODUCT FOR AN APPLICATION INVOLVING SERIOUS RISK TO LIFE OR PROPERTY OR IN LARGE QUANTITIES WITHOUT ENSURING THAT THE SYSTEM AS A WHOLE HAS BEEN DESIGNED TO ADDRESS THE RISKS, AND THAT THE OMRON PRODUCT(S) IS PROPERLY RATED AND INSTALLED FOR THE INTENDED USE WITHIN THE OVERALL EQUIPMENT OR SYSTEM.

### Programmable Products.

Omron Companies shall not be responsible for the user's programming of a programmable Product, or any consequence thereof.

### Performance Data.

Data presented in Omron Company websites, catalogs and other materials is provided as a guide for the user in determining suitability and does not constitute a warranty. It may represent the result of Omron's test conditions, and the user must correlate it to actual application requirements. Actual performance is subject to the Omron's Warranty and Limitations of Liability.

### Change in Specifications.

Product specifications and accessories may be changed at any time based on improvements and other reasons. It is our practice to change part numbers when published ratings or features are changed, or when significant construction changes are made. However, some specifications of the Product may be changed without any notice. When in doubt, special part numbers may be assigned to fix or establish key specifications for your application. Please consult with your Omron's representative at any time to confirm actual specifications of purchased Product.

### Errors and Omissions.

Information presented by Omron Companies has been checked and is believed to be accurate; however, no responsibility is assumed for clerical, typographical or proofreading errors or omissions.

2017.1

In the interest of product improvement, specifications are subject to change without notice.

**OMRON Corporation**  
Industrial Automation Company

<http://www.ia.omron.com/>

(c)Copyright OMRON Corporation 2017 All Right Reserved.