

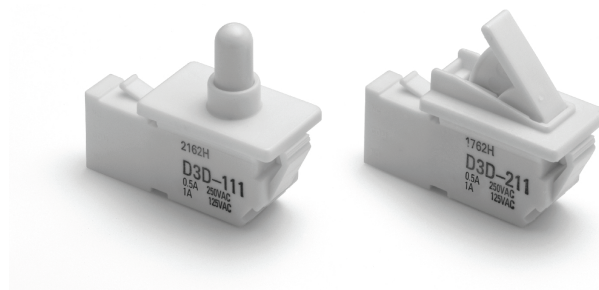

Miniature Door Switch D3D

Unique Mechanism Allows Switching of Micro Loads

- Choose from plunger or lever actuators.
- The internal structure of plunger models provides temporary sealing at the free position.
- Low operating force of 204 g max.
- Disconnectable crimp connector for easier wiring.
- High contact reliability ensured with gold crossbar contacts.
- Low noise operation.
- RoHS Compliant.



Ordering Information

Actuator	Contact form		
	SPDT	SPST-NC	SPST-NO
Plunger 	D3D-111	D3D-121	D3D-131
Lever 	D3D-211	D3D-221	D3D-231

Model Number Legend

D3D - 1
1 2

1. Actuator
1: Plunger
2: Lever

2. Contact Form
1: SPDT
2: SPST-NC
3: SPST-NO

Specifications

Characteristics

Operating speed	7.5 to 500 mm/s
Operating frequency	Mechanical: 120 operations/minute, max. Electrical: 20 operations/minute, max.
Insulation resistance	100 MΩ min. (at 500 VDC)
Contact resistance	100 mΩ max.
Dielectric strength	1,000 VAC, 50/60 Hz for 1 min between terminals of the same polarity 1,500 VAC, 50/60 Hz for 1 min between current-carrying metal parts and ground, and between each terminal and non-current-carrying metal parts
Vibration resistance (See note 2)	Malfunction: 10 to 55 Hz, 1.5-mm double amplitude
Shock resistance (See note 2)	Destruction: 490 m/s ² max. Malfunction: 300 m/s ² max.
Degree of protection	IP00 (IP40 for pin plunger models, when at the free position)
Degree of protection against electric shock	D3D-1 models (plunger models): Class II D3D-2 models (lever models): Class 0
Proof tracking index (PTI)	600
Ambient operating temperature	-30°C to 60°C (with no icing)
Ambient operating humidity	85% max.
Life expectancy	Mechanical: 300,000 operations min. (60 operations per minute) Electrical: 100,000 operations min. (20 operations per minute)
Weight	Approx. 4 g

Note: 1. Data shown are of initial value.

2. The contacts do not open or close for more than 1 ms.

■ Ratings

Rated voltage	Resistive load
125 VAC	1 A
250 VAC	0.5 A

Note: The electrical rating applies under the following test conditions:
Ambient Temperature = 20±2°C, Ambient Humidity = 65±5%, Operating frequency = 30 operations/min.

■ Approved Standards

UL Recognized/CSA Certified

Rated voltage	D3D
125 VAC	1 A
250 VAC	0.5 A

EN61058-1 (VDE approval)

Rated voltage	D3D
125 VAC	1 A
250 VAC	0.5 A

Testing conditions: 5E4 (50,000 operations), T55 (0°C to 55°C)

■ Contact Specifications

Item	Specification
Specification	Crossbar
Material	Gold alloy
Minimum applicable load (see note)	1 mA at 5 VDC

Note: Minimum applicable loads are indicated by N standard reference values. This value represents the failure rate at a 60% (λ_{60}) reliability level (JIS C5003).
The equation $\lambda_{60}=0.5 \times 10^{-6}$ / operations indicates that a failure rate of 1/2,000,000 operations can be expected at a reliability level of 60%.

Engineering Data

■ Panel Cutout Dimensions

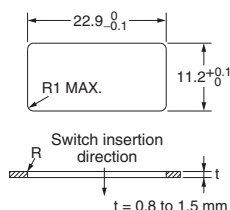

■ Contact Form

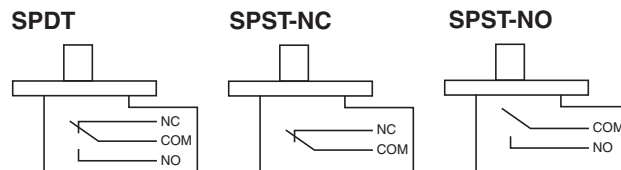

Dimensions

■ Dimensions and Operating Characteristics

- Note:** 1. Unless otherwise specified, all units are in millimeters and a tolerance of ±0.4 mm applies to all dimensions
2. The operating characteristics are for operation in the A direction (indicated by the arrow)

Plunger Models

D3D-111
D3D-121
D3D-131

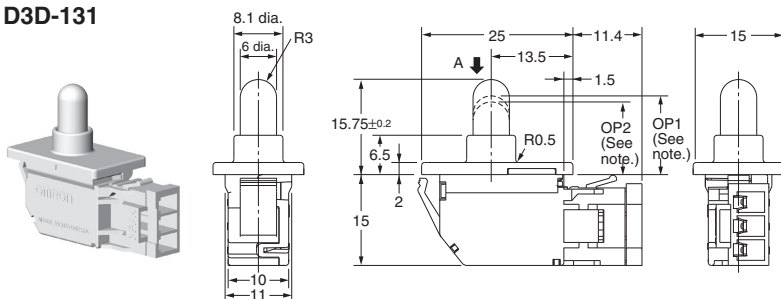

Note: The dimensions OP1 and OP2 apply to the D3D-111 only. The D3D-121 and D3D-131 are SPST-NC and SPST-NO respectively and so therefore have only one corresponding dimension here (OP).

Type	Plunger model		
	D3D-111	D3D-121	D3D-131
OF max.	204 gf		
TTF max.	357 gf		
TT	9.0 mm (reference value)		
OP min.	OP1 (NC-OFF) 13 mm	13 mm	12 mm
	OP2 (NO-ON) 12 mm		

- Note:** 1. Unless otherwise specified, all units are in millimeters and a tolerance of ± 0.4 mm applies to all dimensions
 2. The operating characteristics are for operation in the A direction (indicated by the arrow)

Lever Models

- D3D-211
- D3D-221
- D3D-231

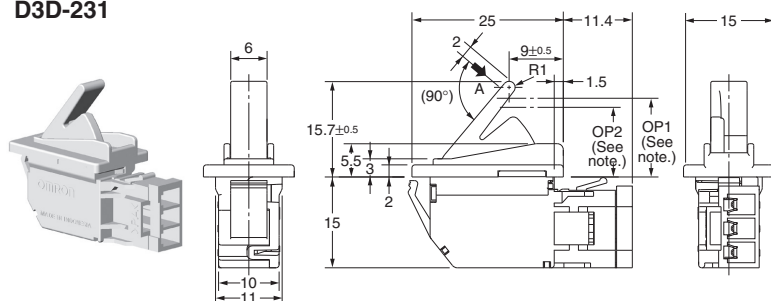

Note: The dimensions OP1 and OP2 apply to the D3D-211 only. The D3D-221 and D3D-231 are SPST-NC and SPST-NO respectively and so therefore have only one corresponding dimension here (OP).

Type Model	Lever model		
	D3D-211	D3D-221	D3D-231
OF max.	204 gf		
TTF max.	357 gf		
TT	9.7 mm (reference value)		
OP min.	OP1 (NC-OFF) 13 mm	13 mm	11.5 mm
	OP2 (NO-ON) 11.5 mm		

Precautions

Be sure to read the precautions and information common to all Snap Action and Detection Switches, contained in the Technical User's Guide, "Snap Action Switches, Technical Information" for correct use.

Correct Use

Mounting

This product does not have waterproof or drip-proof construction. Ensure that water does not enter the switch interior. In particular, do not use the switch in locations where water may be spilled or flow over the switch. Doing so may result in deterioration of the insulation.

Wiring

Do not use the switch with a large force applied to the connector or lead wire. Doing so may result in rattling or contact failure.

Storage Environment

Storing the switch in a plastic bag will help prevent discoloration due to sulfuration of the (silver-plated) terminals.

Do not use the switch in locations subject to harmful gases or to high temperatures or humidity levels. Depending on the location, it is recommended that switches be inspected between 3 and 6 months after the date of manufacture.

Micro Loads

Even when using the switch within the operating range, if there are inrush currents or surges, it may decrease the durability of the switch. If necessary, insert a contact protection circuit.

Connectors

The terminals connect to JST's HL Connector.

The HL Connector consists of the following components.

Contact: SSF-21T-P1.4

Housing: HLP-03V

Omron does not sell the HL Connector.

Contact J.S.T. Manufacturing Co. for these connectors.

Cautions

Handling

Do not expose the switch to shocks, such as by dropping it. Doing so may damage or deform the switch.

Do not apply lubrication to the sliding parts, such as pushbuttons or actuators. Doing so may result in faulty operation or contact failure.

In order to ensure stable contact force for NO contacts, use an operating stroke of at least 5 mm.

All sales are subject to Omron Electronic Components LLC standard terms and conditions of sale, which can be found at http://www.components.omron.com/components/web/webfiles.nsf/sales_terms.html

ALL DIMENSIONS SHOWN ARE IN MILLIMETERS.
To convert millimeters into inches, multiply by 0.03937. To convert grams into ounces, multiply by 0.03527.

OMRON[®]

**OMRON ELECTRONIC
COMPONENTS LLC**

55 E. Commerce Drive, Suite B
Schaumburg, IL 60173

847-882-2288

OMRON ON-LINE

Global - <http://www.omron.com>

USA - <http://www.components.omron.com>