

D2VW

Sealed Miniature Basic Switch

Sealed Miniature Basic Switch Conforms to IP67 (Excluding the terminals on terminal models)

- Use of epoxy resin assures stable sealing, making this switch ideal for places subject to water spray or excessive dust.
- V-series internal mechanism assures high precision and durability. The mounting is the same as of the V models.
- Ideal for automobiles, agricultural machines, large-scale home appliances, and industrial equipment, which require high environmental resistance.

RoHS Compliant

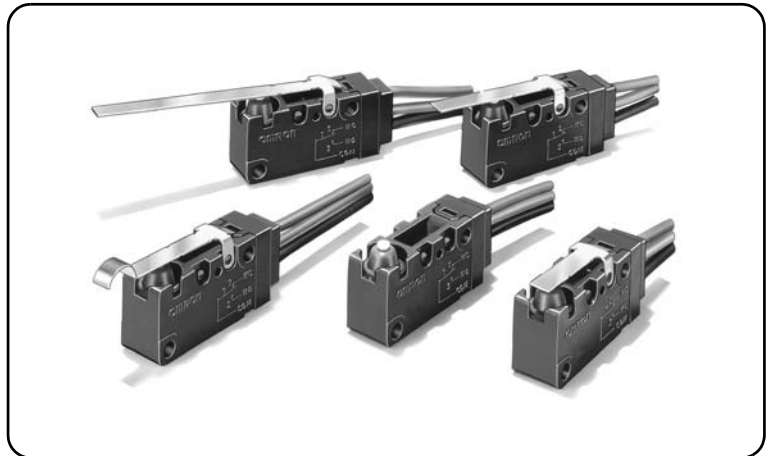





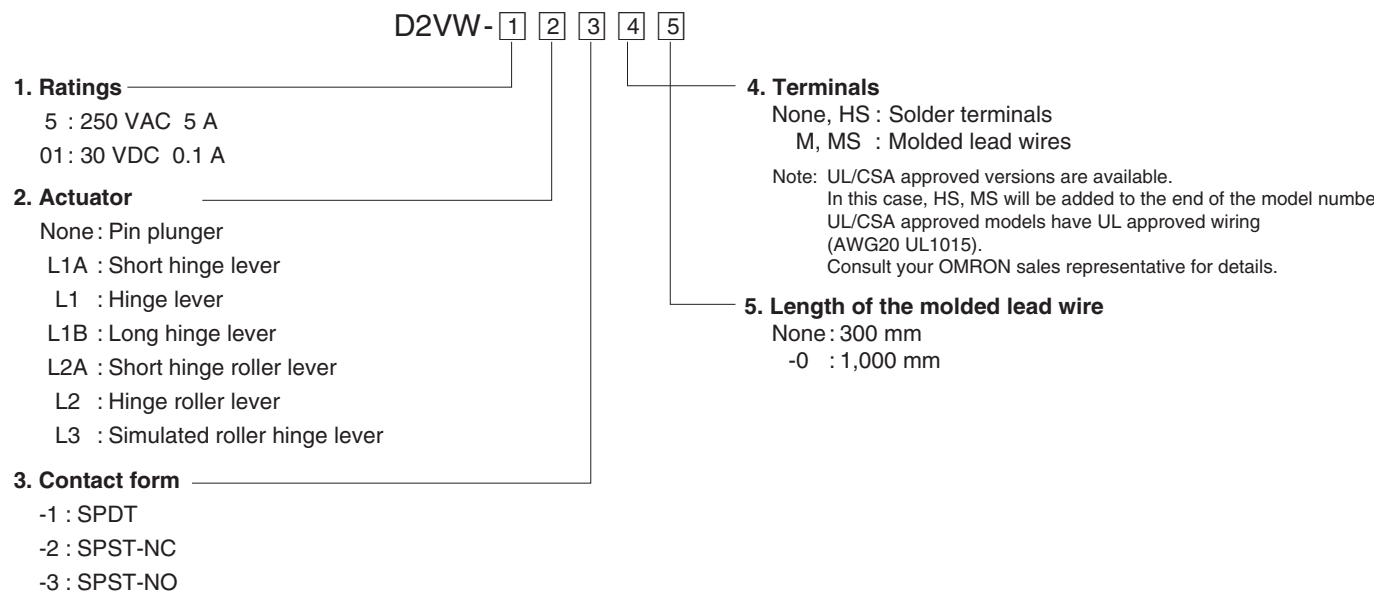

D
2
V
W

Model Number Legend









List of Models

Actuator	Terminals	Ratings	5 A	0.1 A
		Contact form		
Pin plunger 	Solder terminals	SPDT	D2VW-5-1	D2VW-01-1
		SPST-NC	D2VW-5-2	D2VW-01-2
		SPST-NO	D2VW-5-3	D2VW-01-3
	Molded lead wires (300 mm)	SPDT	D2VW-5-1M	D2VW-01-1M
		SPST-NC	D2VW-5-2M	D2VW-01-2M
		SPST-NO	D2VW-5-3M	D2VW-01-3M
Molded lead wires (1,000 mm)	SPDT	D2VW-5-1M-0	D2VW-01-1M-0	
Short hinge lever 	Solder terminals	SPDT	D2VW-5L1A-1	D2VW-01L1A-1
		SPST-NC	D2VW-5L1A-2	D2VW-01L1A-2
		SPST-NO	D2VW-5L1A-3	D2VW-01L1A-3
	Molded lead wires (300 mm)	SPDT	D2VW-5L1A-1M	D2VW-01L1A-1M
		SPST-NC	D2VW-5L1A-2M	D2VW-01L1A-2M
		SPST-NO	D2VW-5L1A-3M	D2VW-01L1A-3M
Molded lead wires (1,000 mm)	SPDT	D2VW-5L1A-1M-0	D2VW-01L1A-1M-0	
Hinge lever 	Solder terminals	SPDT	D2VW-5L1-1	D2VW-01L1-1
		SPST-NC	D2VW-5L1-2	D2VW-01L1-2
		SPST-NO	D2VW-5L1-3	D2VW-01L1-3
	Molded lead wires (300 mm)	SPDT	D2VW-5L1-1M	D2VW-01L1-1M
		SPST-NC	D2VW-5L1-2M	D2VW-01L1-2M
		SPST-NO	D2VW-5L1-3M	D2VW-01L1-3M
Molded lead wires (1,000 mm)	SPDT	D2VW-5L1-1M-0	D2VW-01L1-1M-0	
Long hinge lever 	Solder terminals	SPDT	D2VW-5L1B-1	D2VW-01L1B-1
		SPST-NC	D2VW-5L1B-2	D2VW-01L1B-2
		SPST-NO	D2VW-5L1B-3	D2VW-01L1B-3
	Molded lead wires (300 mm)	SPDT	D2VW-5L1B-1M	D2VW-01L1B-1M
		SPST-NC	D2VW-5L1B-2M	D2VW-01L1B-2M
		SPST-NO	D2VW-5L1B-3M	D2VW-01L1B-3M
Molded lead wires (1,000 mm)	SPDT	D2VW-5L1B-1M-0	D2VW-01L1B-1M-0	
Short hinge roller lever 	Solder terminals	SPDT	D2VW-5L2A-1	D2VW-01L2A-1
		SPST-NC	D2VW-5L2A-2	D2VW-01L2A-2
		SPST-NO	D2VW-5L2A-3	D2VW-01L2A-3
	Molded lead wires (300 mm)	SPDT	D2VW-5L2A-1M	D2VW-01L2A-1M
		SPST-NC	D2VW-5L2A-2M	D2VW-01L2A-2M
		SPST-NO	D2VW-5L2A-3M	D2VW-01L2A-3M
Molded lead wires (1,000 mm)	SPDT	D2VW-5L2A-1M-0	D2VW-01L2A-1M-0	
Hinge roller lever 	Solder terminals	SPDT	D2VW-5L2-1	D2VW-01L2-1
		SPST-NC	D2VW-5L2-2	D2VW-01L2-2
		SPST-NO	D2VW-5L2-3	D2VW-01L2-3
	Molded lead wires (300 mm)	SPDT	D2VW-5L2-1M	D2VW-01L2-1M
		SPST-NC	D2VW-5L2-2M	D2VW-01L2-2M
		SPST-NO	D2VW-5L2-3M	D2VW-01L2-3M
Molded lead wires (1,000 mm)	SPDT	D2VW-5L2-1M-0	D2VW-01L2-1M-0	
Simulated roller hinge lever 	Solder terminals	SPDT	D2VW-5L3-1	D2VW-01L3-1
		SPST-NC	D2VW-5L3-2	D2VW-01L3-2
		SPST-NO	D2VW-5L3-3	D2VW-01L3-3
	Molded lead wires (300 mm)	SPDT	D2VW-5L3-1M	D2VW-01L3-1M
		SPST-NC	D2VW-5L3-2M	D2VW-01L3-2M
		SPST-NO	D2VW-5L3-3M	D2VW-01L3-3M
Molded lead wires (1,000 mm)	SPDT	D2VW-5L3-1M-0	D2VW-01L3-1M-0	

D
2
V
W

Separator (Sold Separately), Actuator (Sold Separately), Terminal Connector (Sold Separately) ➔ Refer to "Basic Switch Common Accessories"

●Safety Standard Approved Models

Actuator	Terminals	Ratings Contact form	5A	0.1A
Pin plunger 	Solder terminals	SPDT	D2VW-5-1HS	D2VW-01-1HS
	Molded lead wires (300 mm)		D2VW-5-1MS	D2VW-01-1MS
Short hinge lever 	Solder terminals		D2VW-5L1A-1HS	D2VW-01L1A-1HS
	Molded lead wires (300 mm)		D2VW-5L1A-1MS	D2VW-01L1A-1MS
Hinge lever 	Solder terminals		D2VW-5L1-1HS	D2VW-01L1-1HS
	Molded lead wires (300 mm)		D2VW-5L1-1MS	D2VW-01L1-1MS
Long hinge lever 	Solder terminals		D2VW-5L1B-1HS	D2VW-01L1B-1HS
	Molded lead wires (300 mm)		D2VW-5L1B-1MS	D2VW-01L1B-1MS
Short hinge roller lever 	Solder terminals		D2VW-5L2A-1HS	D2VW-01L2A-1HS
	Molded lead wires (300 mm)		D2VW-5L2A-1MS	D2VW-01L2A-1MS
Hinge roller lever 	Solder terminals		D2VW-5L2-1HS	D2VW-01L2-1HS
	Molded lead wires (300 mm)		D2VW-5L2-1MS	D2VW-01L2-1MS
Simulated roller hinge lever 	Solder terminals		D2VW-5L3-1HS	D2VW-01L3-1HS
	Molded lead wires (300 mm)		D2VW-5L3-1MS	D2VW-01L3-1MS

D
2
V
W

Contact Form

●SPDT

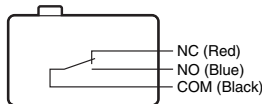

●SPST-NC

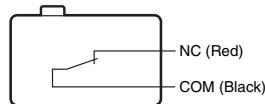

●SPST-NO

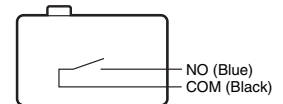

The color in parentheses indicates the color of the lead wire.

Contact Specifications

Item	Model	D2VW-5 models	D2VW-01 models
Contact	Specification	Rivet	Crossbar
	Material	Silver alloy	Gold alloy
	Gap (standard value)	0.5 mm	
Inrush current	NC	15A max.	-
	NO	15A max.	-
Minimum applicable load (reference value) *		5 VDC 160 mA	5 VDC 1 mA

* Please refer to "Using Micro Loads" in "●Precautions" for more information on the minimum applicable load.

Ratings

Model	Item		Resistive load
	Rated voltage		
D2VW-5 models	250 VAC	5 A	5 A
	125 VAC	5 A	
	30 VDC	5 A	
D2VW-01 models	125 VAC	0.1 A	0.1 A
	30 VDC	0.1 A	

Note. The above rating values apply under the following test conditions.

- (1) Ambient temperature: 20±2°C
- (2) Ambient humidity: 65±5%
- (3) Operating frequency: 30 operations/min

Approved Safety Standards

UL (UL1054)/CSA (CSA C22.2 No.55)

The terminal specification for models with UL/CSA safety standard certification is "HS" or "MS."

Rated voltage	Model	D2VW-5	D2VW-01
125 VAC 250 VAC		3 A	0.1 A
		3 A	-
30 VDC		-	0.1 A

VDE (EN61058-1)

The models in the *List of Models* on the previous page are not certified for VDE standards.

Contact your OMRON representative if you require certified models.

Rated voltage	Model	D2VW-5	D2VW-01
125 VAC 250 VAC		-	0.1 A
		3 A	-

Testing conditions: D2VW-5 25E3 (25,000 operations)
T55 (0 to 55°C)
D2VW-01 1E5 (100,000 operations)
T85 (0 to 85°C)

Separator (Sold Separately), Actuator (Sold Separately), Terminal Connector (Sold Separately) ➔ Refer to "Micro Switch Common Accessories"

Characteristics

Item	Model	D2VW-5 models	D2VW-01 models
Permissible operating speed		0.1mm to 1m/s (for pin plunger models)	
Permissible operating frequency	Mechanical	300 operations/min	
	Electrical	60 operations/min	
Insulation resistance		100 MΩ min. (500 VDC with insulation tester)	
Contact resistance (initial value)	Terminal models	50 mΩ max.	
	Molded lead wire terminals (300mm)	100 mΩ max.	
	Molded lead wire terminals (1,000mm)	200 mΩ max.	
Dielectric strength *1	Between terminals of the same polarity	1,000 VAC 50/60 Hz for 1 min	
	Between current-carrying metal parts and ground	1,500 VAC 50/60 Hz for 1 min	
	Between terminals and non-current-carrying metal parts	1,500 VAC 50/60 Hz for 1 min	
Vibration resistance *2	Malfunction	10 to 55 Hz, 1.5 mm double amplitude	
Shock resistance	Destruction	1,000m/s ² (approx. 100G) max.	
	Malfunction *2	300m/s ² (approx. 30G) max.	
Durability *3	Mechanical	10,000,000 operations min. (60 operations/min)	
	Electrical	100,000 operations min. (30 operations/min)	1,000,000 operations min. (30 operations/min)
Degree of protection	Terminal models	IEC IP67 (excluding the terminals on terminal models)	
	Molded lead wire models	IEC IP67	
Degree of protection against electric shock		Class I	
Proof tracking index (PTI)		175	
Ambient operating temperature		-40°C to +85°C (at ambient humidity of 60% max.) (with no icing or condensation)	
Ambient operating humidity		95% max. (for +5°C to +35°C)	
Weight		Approx. 7 g (for pin plunger models with terminals)	

Note. The data given above are initial values.

- *1. The dielectric strength shown in the table indicates the value for models with a Separator (refer to "Basic Switch Common Accessories").
- *2. For the pin plunger models, the above values apply for use at the free position and total travel position. For the lever models, they apply at the total travel position. Close or open circuit of the contact is 1 ms max.
- *3. For testing conditions, consult your OMRON sales representative.

Mounting Holes (Unit: mm)

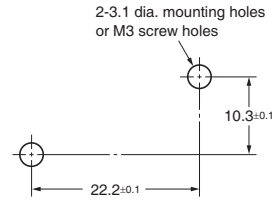

D
2
V
W

Dimensions (Unit: mm) and Operating Characteristics

Models with solder terminals

The illustrations and dimensions are for pin plunger models.

Dimensions and operation characteristics of other actuator models are the same as those of molded lead wires models.

● Pin Plunger Models

D2VW-5-1
D2VW-01-1

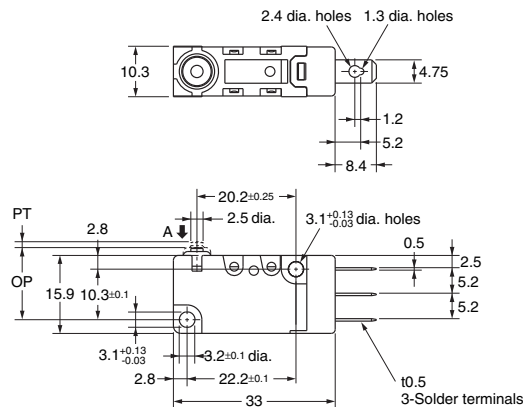
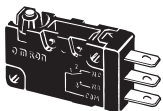

Operating Force	OF	Max.	1.96 N {200 gf}
Releasing Force	RF	Min.	0.29 N {30 gf}
Pretravel	PT	Max.	1.2 mm
Overtravel	OT	Min.	1.0 mm
Movement Differential	MD	Max.	0.4 mm
Operating Position	OP		14.7±0.4 mm

Note 1. Unless otherwise specified, a tolerance of ±0.4 mm applies to all dimensions.

Note 2. The operating characteristics are for operation in the A direction (↓).

Models with molded lead wires

The illustration and drawing shown is the SPDT model. SPST-NC model and SPST-NO model are omitted.

●Pin Plunger Models

- D2VW-5-1M
- D2VW-5-1M-0
- D2VW-01-1M
- D2VW-01-1M-0

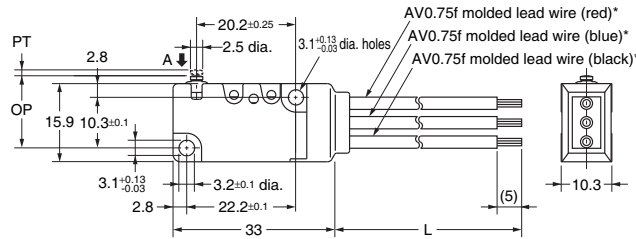
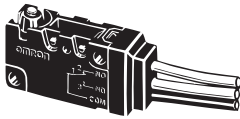

Dimensions

	300 mm type	1,000 mm type
L	300 \pm 10	1,000 \pm 30

Operating Force	OF Max.	1.96 N {200 gf}
Releasing Force	RF Min.	0.29 N {30 gf}
Pretravel	PT Max.	1.2 mm
Overtravel	OT Min.	1.0 mm
Movement Differential	MD Max.	0.4 mm
Operating Position	OP	14.7 \pm 0.4 mm

* UL/CSA approved models have UL approved wiring (AWG20 UL1015).

●Short Hinge Lever Models

- D2VW-5L1A-1M
- D2VW-5L1A-1M-0
- D2VW-01L1A-1M
- D2VW-01L1A-1M-0

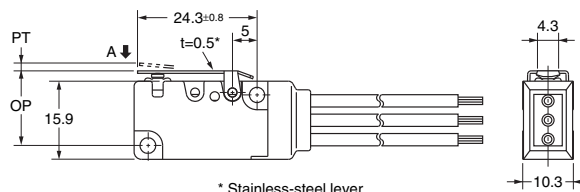
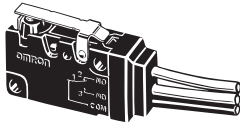

Operating Force	OF Max.	1.96 N {200 gf}
Releasing Force	RF Min.	0.20 N {20 gf}
Pretravel	PT Max.	1.6 mm
Overtravel	OT Min.	0.8 mm
Movement Differential	MD Max.	0.5 mm
Operating Position	OP	15.2 \pm 0.5 mm

●Hinge Lever Models

- D2VW-5L1-1M
- D2VW-5L1-1M-0
- D2VW-01L1-1M
- D2VW-01L1-1M-0

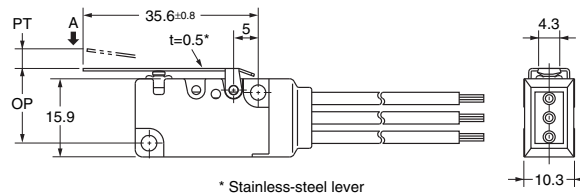
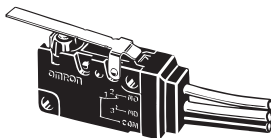

Operating Force	OF Max.	1.18 N {120 gf}
Releasing Force	RF Min.	0.15 N {15 gf}
Pretravel	PT Max.	4.0 mm
Overtravel	OT Min.	1.6 mm
Movement Differential	MD Max.	0.8 mm
Operating Position	OP	15.2 \pm 1.2 mm

●Long Hinge Lever Models

- D2VW-5L1B-1M
- D2VW-5L1B-1M-0
- D2VW-01L1B-1M
- D2VW-01L1B-1M-0

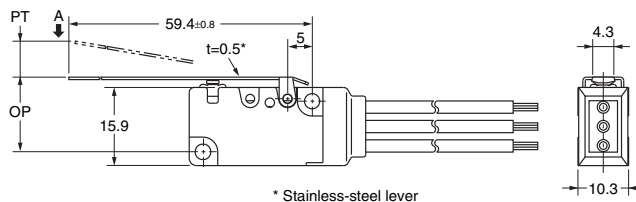
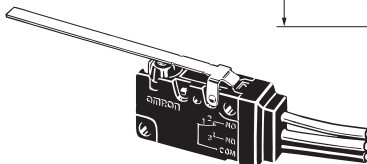

Operating Force	OF Max.	0.59 N {60 gf}
Releasing Force	RF Min.	0.05 N {5 gf}
Pretravel	PT Max.	9.0 mm
Overtravel	OT Min.	3.2 mm
Movement Differential	MD Max.	2.0 mm
Operating Position	OP	15.2 \pm 2.6 mm

●Simulated Roller Lever Hinge Models

- D2VW-5L3-1M
- D2VW-5L3-1M-0
- D2VW-01L3-1M
- D2VW-01L3-1M-0

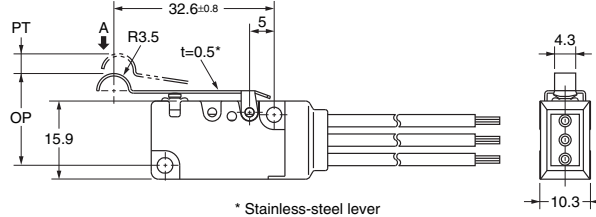
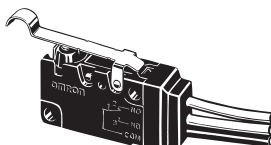

Operating Force	OF Max.	1.18 N {120 gf}
Releasing Force	RF Min.	0.15 N {15 gf}
Pretravel	PT Max.	4.0 mm
Overtravel	OT Min.	1.6 mm
Movement Differential	MD Max.	0.8 mm
Operating Position	OP	18.7 \pm 1.2 mm

Note 1. Unless otherwise specified, a tolerance of ± 0.4 mm applies to all dimensions.

Note 2. The operating characteristics are for operation in the A direction (↓).

Models with molded lead wires

●Short Hinge Roller Lever Models

- D2VW-5L2A-1M
- D2VW-5L2A-1M-0
- D2VW-01L2A-1M
- D2VW-01L2A-1M-0

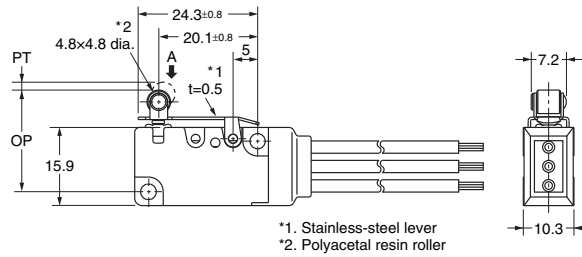
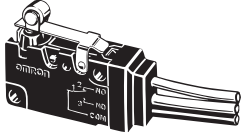

Operating Force	OF	Max.	2.25 N {230 gf}
Releasing Force	RF	Min.	0.20 N {20 gf}
Pretravel	PT	Max.	1.6 mm
Overtravel	OT	Min.	0.8 mm
Movement Differential	MD	Max.	0.5 mm
Operating Position	OP		20.7±0.6 mm

*1. Stainless-steel lever
*2. Polyacetal resin roller

●Hinge roller lever

- D2VW-5L2-1M
- D2VW-5L2-1M-0
- D2VW-01L2-1M
- D2VW-01L2-1M-0

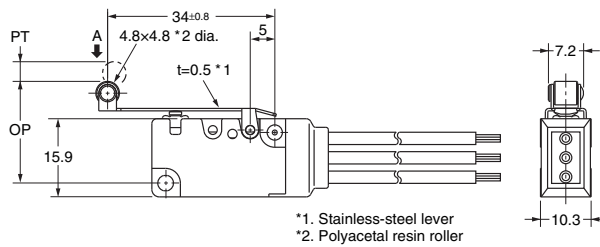
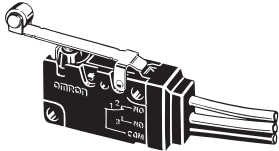

Operating Force	OF	Max.	1.18 N {120 gf}
Releasing Force	RF	Min.	0.15 N {15 gf}
Pretravel	PT	Max.	4.0 mm
Overtravel	OT	Min.	1.6 mm
Movement Differential	MD	Max.	0.8 mm
Operating Position	OP		20.7±1.2 mm

*1. Stainless-steel lever
*2. Polyacetal resin roller

Note 1. Unless otherwise specified, a tolerance of ±0.4 mm applies to all dimensions.

Note 2. The operating characteristics are for operation in the A direction (↓).

Precautions

★Please refer to "Basic Switches Common Precautions" for correct use.

Cautions

●Degree of Protection

Do not use the Switch underwater.

The Switch was tested and found to meet the conditions necessary to meet the following standard, however, the test checks for water intrusion after immersion for a specified time period, not for switching operation underwater.

JIS C0920:

Degrees of protection provided by enclosures of electrical apparatus (IP Code)

IEC 60529:

Degrees of protection provided by enclosures (IP Code)

Degree of protection: IP67

(check water intrusion after immersion for 30 min submerged 1 m underwater)

●Protection Against Chemicals

Prevent the Switch from coming into contact with oil or chemicals.

Otherwise, damage to or deterioration of Switch materials may result.

●Soldering

- Connecting to Solder Terminals

When soldering the lead wire to the terminal, first insert the lead wire conductor through the terminal hole and then conduct soldering.

Complete the soldering at the iron tip temperature between 350 to 400°C within 5 seconds, and do not apply any external force for 1 minute after soldering. Soldering at a excessively high temperature or soldering for more than 5 s may deteriorate the characteristics of the Switch.

Correct Use

●Mounting

Use M3 mounting screw with plane washers or spring washers to securely mount the Switch. Tighten the screws to a torque of 0.39 to 0.59 N·m {4 to 6 kgf·cm}.

●Operating Body

With the pin plunger models, set the Switch so that the plunger can be pushed in from directly above. Since the plunger is covered with a rubber cap, applying a force from lateral directions may cause damage to the plunger or reduction in the sealing capability.

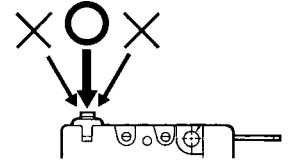

●Handling

Handle the Switch carefully so as not to break the sealing rubber.

●Using Micro Loads

Using a model for ordinary loads to open or close the contact of a micro load circuit may result in faulty contact. Use models that operate in the following range. However, even when using micro load models within the following operating range, if inrush current occurs when the contact is opened or closed, it may increase the contact wear and so decrease durability. Therefore, insert a contact protection circuit where necessary. The N-level reference value applies for the minimum applicable load. This value indicates the malfunction reference level for the reliability level of 60% (λ_{60}).

(JIS C5003)

The equation, $\lambda_{60}=0.5 \times 10^{-6} / \text{operations}$ indicates that the estimated malfunction rate is less than $\frac{1}{2,000,000}$ operations with a reliability level of 60%.

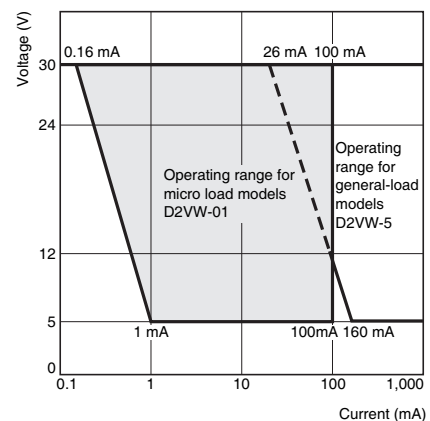

• Application examples provided in this document are for reference only. In actual applications, confirm equipment functions and safety before using the product.
• Consult your OMRON representative before using the product under conditions which are not described in the manual or applying the product to nuclear control systems, railroad systems, aviation systems, vehicles, combustion systems, medical equipment, amusement machines, safety equipment, and other systems or equipment that may have a serious influence on lives and property if used improperly. Make sure that the ratings and performance characteristics of the product provide a margin of safety for the system or equipment, and be sure to provide the system or equipment with double safety mechanisms.

Note: Do not use this document to operate the Unit.