

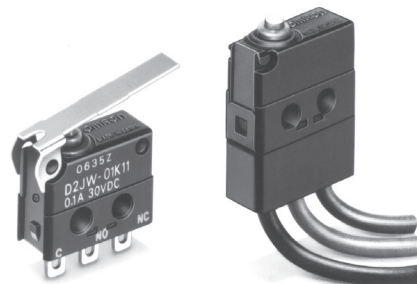







Sealed Snap Action Switch D2JW

Immersion-Proof Subminiature Snap Action Switch

- Ultra-small and highly sealed
- Water-tight housing conforming to IEC IP67
- Wide range of operating temperature from -40° to 85°C
- Gold crossbar contact and coil spring offer long life expectancy and high reliability
- RoHS Compliant



Ordering Information

| Actuator | Model | |
|---|--|--|
| | Solder terminal  | Molded lead wires  |
| Pin plunger  | D2JW-011 | D2JW-011-MD |
| Short hinge lever  | D2JW-01K1A1 | D2JW-01K1A1-MD |
| Hinge lever  | D2JW-01K11 | D2JW-01K11-MD |
| Simulated roller lever  | D2JW-01K31 | D2JW-01K31-MD |
| Hinge roller lever  | D2JW-01K21 | D2JW-01K21-MD |

Note: The length of the standard molded lead wire (AVS0.3f) is 30 cm (12 in).

Model Number Legend

D2JW-01 □ - □ - □
1 2 3 4

- | | | | |
|--|--|---|---|
| <p>1. Ratings 01: 0.1 A at 30 VDC</p> | <p>2. Actuator None: Pin plunger K1A: Short hinge lever K1: Hinge lever K3: Simulated roller lever K2: Hinge roller lever</p> | <p>3. Contact Form 1: SPDT 2: SPST-NC* 3: SPST-NO* *Lead wire versions only</p> | <p>4. Terminals None: Solder terminals MD: Molded lead wires</p> |
|--|--|---|---|

Note: Consult Omron regarding SPST-NO and SPST-NC models.

Specifications

■ Characteristics

| | |
|---|--|
| Operating speed (see note 2) | 1 mm to 250 mm/second |
| Operating frequency | Mechanical: 240 operations per minute max. Electrical: 30 operations per minute max. |
| Contact resistance | 100 mΩ max. (Molded lead type: 140 mΩ min.) |
| Insulation resistance | 100 MΩ min. (at 500 VDC) |
| Dielectric strength (See note 3) | 600 VAC, 50/60 Hz for 1 minute between terminals of same polarity 1,000 VAC, 50/60 Hz for 1 minute between current-carrying metal part and ground, and between each terminal and noncurrent-carrying metal part |
| Vibration resistance (See note 4) | Malfunction: 10 to 55 Hz, 1.5 mm double amplitude |
| Shock resistance (See note 4) | Destruction: 1,000 m/s ² (approx. 100G) max. Malfunction: 200 m/s ² (approx. 20G) max. |
| Ambient operating temperature | -40° to 85°C (at 60% RH) with no icing or condensation |
| Ambient operating humidity | 35% to 98% (for 5°C to 35°C) |
| Degree of protection | IEC IP67 (excluding the terminals on terminal models) |
| Degree of protection against electric shock | Class I |
| Proof tracking index (PRTI) | 175 |
| Service life | Mechanical: 1,000,000 operations min. at 60 operations per minute Electrical: 100,000 operations min. at 30 operations per minute |
| Weight | Approx. 7 g (pin plunger with molded lead wire models) |

- Note:** 1. Data shown are of initial value.
 2. The values are for pin plunger type.
 3. The dielectric strength values shown apply when using a separator (terminal type)
 4. The values shown apply for malfunctions of 1 ms max.

■ Ratings

| | |
|-------------------|--------------------------------|
| Electrical rating | 0.1 A, 30 VDC (resistive load) |
|-------------------|--------------------------------|

- Note:** The ratings apply under the following test conditions:
 Ambient Temperature = 20±2°C,
 Ambient Humidity = 65±5%,
 Operating frequency = 30 operations/min.

■ Contact Specifications

| Item | Specification |
|------------------------------------|---------------|
| Specification | Crossbar |
| Material | Gold alloy |
| Gap (standard value) | 0.5 mm |
| Inrush current | 0.1 A max. |
| Minimum applicable load (see note) | 1 mA at 5 VDC |

Note: Minimum applicable loads are indicated by N standard reference values. This value represents the failure rate at a 60% (λ_{60}) reliability level (JIS C5003).
 The equation $\lambda_{60}=0.5 \times 10^{-6} / \text{operations}$ indicates that a failure rate of 1/2,000,000 operations can be expected at a reliability level of 60%

Engineering Data

■ Construction

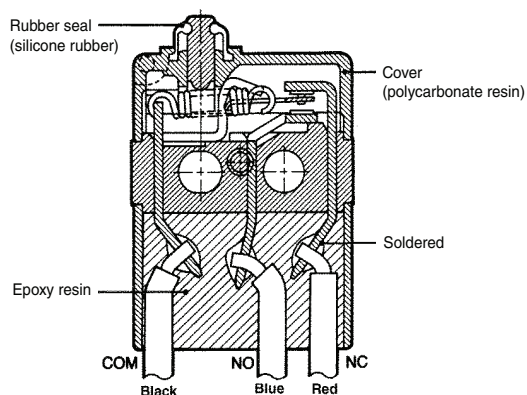

■ Contact Form

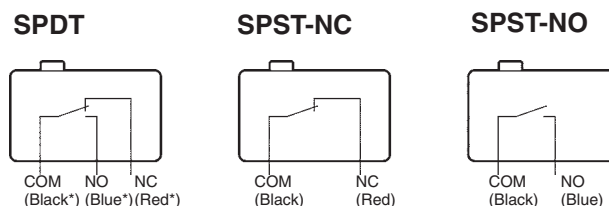

*Indicates the color of the lead wire.

Dimensions

■ Terminals

Note: Unless otherwise specified, all units are in millimeters and a tolerance of ± 0.4 mm applies to all dimensions

Solder Terminals

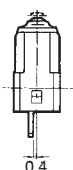
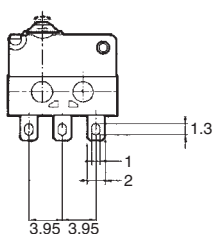

Molded Lead Wires

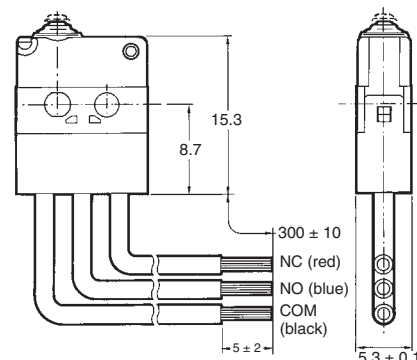

■ Mounting

All switches may be panel mounted using M2.3 mounting screws with plane washers or spring washers to securely mount the switch. Tighten the screws to a torque of 0.20 to 0.29 N-m.

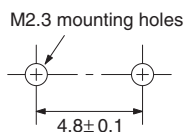

■ Dimensions and Operating Characteristics

- Note:**
1. Unless otherwise specified, all units are in millimeters and a tolerance of ± 0.4 mm applies to all dimensions
 2. The following illustrations and dimensions are for models with PCB terminals. Refer to "Terminals" for models with molded lead wires.
 3. The operating characteristics are for operation in the A direction (▼)

Pin Plunger Models

D2JW-011

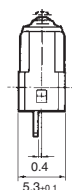
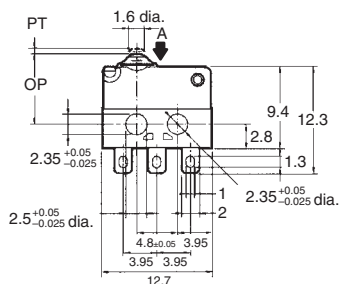
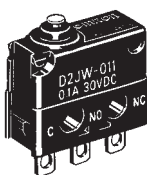

| | |
|---------|--------------|
| OF max. | 250 gf |
| RF min. | 100 gf |
| PT max. | 0.6 mm |
| OT min. | 0.3 mm |
| MD max. | 0.1 mm |
| OP | 8.1 ± 0.3 mm |

Short Hinge Lever Models

D2JW-01K1A1

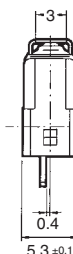
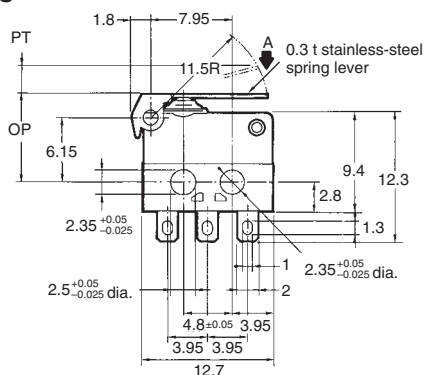
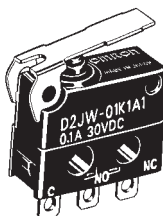

| | |
|---------|--------------|
| OF max. | 117 gf |
| RF min. | 23 gf |
| PT max. | 5.4 mm |
| OT min. | 0.7 mm |
| MD max. | 0.5 mm |
| OP | 8.4 ± 0.8 mm |

- Note:** 1. Unless otherwise specified, all units are in millimeters and a tolerance of ± 0.4 mm applies to all dimensions
 2. The following illustrations and dimensions are for models with PCB terminals. Refer to "Terminals" for models with molded lead wires.
 3. The operating characteristics are for operation in the A direction(▼)

Hinge Lever Models

D2JW-01K11

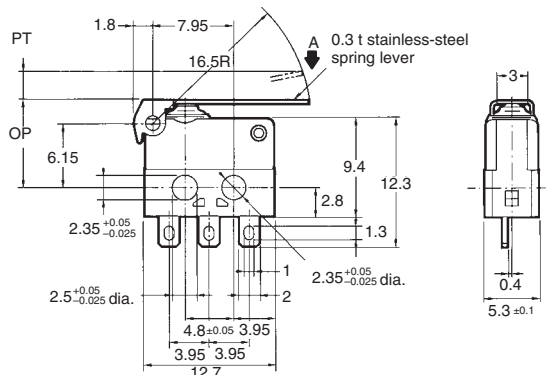
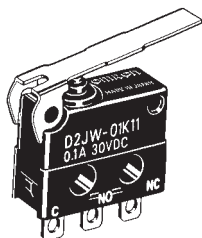

| | |
|---------|------------------|
| OF max. | 82 gf |
| RF min. | 16 gf |
| PT max. | 6.4 mm |
| OT min. | 1.4 mm |
| MD max. | 0.7 mm |
| OP | 8.4 \pm 0.8 mm |

Simulated Roller Lever Models

D2JW-01K31

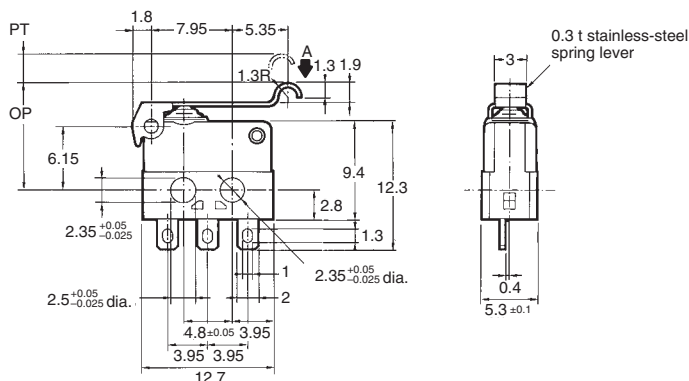
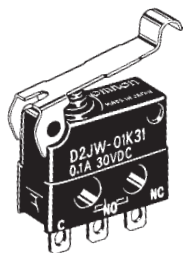

| | |
|---------|-------------------|
| OF max. | 97 gf |
| RF min. | 20 gf |
| PT max. | 5.5 mm |
| OT min. | 1.1 mm |
| MD max. | 0.6 mm |
| OP | 10.3 \pm 0.8 mm |

Hinge Roller Lever Models

D2JW-01K21

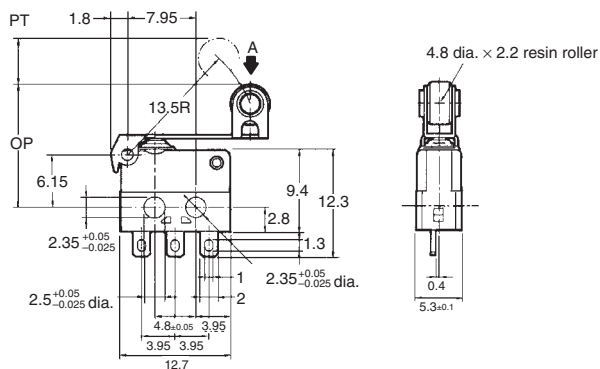
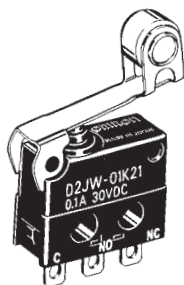

| | |
|---------|-------------------|
| OF max. | 100 gf |
| RF min. | 20 gf |
| PT max. | 5.2 mm |
| OT min. | 1.1 mm |
| MD max. | 0.5 mm |
| OP | 14.6 \pm 0.8 mm |

Precautions

Be sure to read the precautions and information common to all Snap Action and Detection Switches, contained in the Technical User's Guide, "Snap Action Switches, Technical Information" for correct use.

■ Protection against chemicals

Prevent the switch from coming into contact with oil and chemicals. Otherwise, damage to or deterioration of switch materials may result.

Because the switch uses polycarbonate resin as material for its component parts, contact OMRON if the switch material is likely to deteriorate due to adherence of oil or chemicals to the switch housing.

■ Soldering

To solder the lead to the terminal, apply a soldering iron rated at 30 W max. (temperature of soldering iron: 250°C max.) for no more than 3 seconds.

Note that if soldering is not carried out under the proper conditions, there is a danger of over-heating and subsequent heat damage.

Applying a soldering iron for more than three seconds or using one that is rated at more than 30 W may degrade the switch characteristics.

■ Operation

Make sure that the operating body pushes the switch actuator with an adequate force when the switch is to be operated, and that it does not touch the actuator when the switch is released.

Install the pin plunger switch so that the operating force is applied in alignment with the stroke of the actuator.

Do not apply excessive force to the actuator; otherwise, the switch may be damaged.

■ Degree of Protection

The D2JW satisfies the following test condition specified by the IEC Publication 529 (Degree of Protection by Enclosure):

Degree of protection: IP67

Test method: See the figure below.

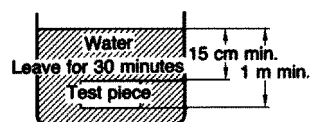

Leave the test piece in water for 30 minutes with the top of the test piece submerged 15 cm or more below the water level and the bottom of the test piece submerged 1 m or more below the water level.

This test is to check the ingress of water into the switch enclosure after submerging the switch in water for a given time. Note that even if this test condition is met, the switch cannot be used in water.

■ Separator

When mounting the switch on a metallic surface, be sure to provide a separator between the switch and the mounting plates.

Reference the following dimensions when designing the separator;

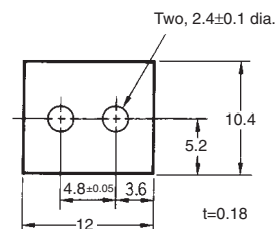

All sales are subject to Omron Electronic Components LLC standard terms and conditions of sale, which can be found at http://www.components.omron.com/components/web/webfiles.nsf/sales_terms.html

ALL DIMENSIONS SHOWN ARE IN MILLIMETERS.
To convert millimeters into inches, multiply by 0.03937. To convert grams into ounces, multiply by 0.03527.

OMRON[®]

**OMRON ELECTRONIC
COMPONENTS LLC**

55 E. Commerce Drive, Suite B
Schaumburg, IL 60173

847-882-2288

OMRON ON-LINE

Global - <http://www.omron.com>

USA - <http://www.components.omron.com>

Cat. No. X303-E-1a

07/11

Specifications subject to change without notice

Printed in USA