

# D Series Miniature Snap-in Power Rocker Switches

## Features/Benefits

- Momentary and maintained models
- PC and quick connect terminals
- Recessed bracket available – prevents accidental actuation
- RoHS compliant

## Typical Applications

- Small appliances
- Computers and peripherals
- Medical instrumentation



Models Available

## Specifications

CONTACT RATING: D10X and D20X Models: 4 AMPS @ 125 V AC; 2 AMPS @ 250 V AC. D50X and D60X Models: 10 AMPS @ 125 V AC; 5 AMPS @ 250 V AC.

ELECTRICAL LIFE: 10,000 make-and-break cycles at full load.

INSULATION RESISTANCE:  $10^9 \Omega$  min.

DIELECTRIC STRENGTH: 1,000 Vrms min. @ sea level.

**NOTE:** Specifications and materials listed above are for standard switches. For information on specific and custom switches, consult Customer Service Center.

## Materials

ACTUATOR & HOUSING: 6/6 nylon (UL 94V-2), color black, finish: matte.

MOVABLE CONTACTS: D10X and D20X Models: Copper, silver plated. D50X and D60X Models: Coin silver, silver plated.

STATIONARY CONTACTS AND TERMINALS: Copper or brass, silver plated.

CONTACT SPRING: Music wire or stainless steel.

OPERATING TEMPERATURE: -30°C to +65°C

## Build-A-Switch

To order, simply select desired option from each category and place in the appropriate box. Available options are shown and described on pages G-62 through G-65. For additional options not shown in catalog, consult Customer Service Center.

<p><b>Switch Function</b></p> <p><b>D101</b> SPDT, On-None-On  <b>D102</b> SPST, On-None-Off  <b>D103</b> SPDT, On-Off-On  <b>D105</b> SPDT, Mom.-Off-Mom.  <b>D108</b> SPDT, Mom.-None-On  <b>D201</b> DPDT, On-None-On  <b>D202</b> DPST, On-None-Off  <b>D203</b> DPDT, On-Off-On  <b>D501</b> SPDT, On-None-On  <b>D502</b> SPST, On-None-Off  <b>D503</b> SPDT, On-Off-On  <b>D508</b> SPDT, Mom.-None-On  <b>D601</b> DPDT, On-None-On  <b>D602</b> DPST, On-None-Off  <b>D608</b> DPDT, Mom.-None-On</p>	<p><b>Actuator</b></p> <p><b>J1</b> Rocker  <b>J5</b> Lever</p> <p><b>Actuator Color</b></p> <p><b>2</b> Black  <b>1</b> White  <b>3</b> Red</p> <p><b>Mounting Style/Color</b></p> <p><b>S2</b> Snap-in, black  <b>B2</b> Recessed snap-in actuator guard, black  <b>G2</b> Actuator guard, black  <b>S1</b> Snap-in, white</p> <p><b>Terminations</b></p> <p><b>15</b> Quick connect  <b>A</b> Right angle, PC thru-hole  <b>02</b> PC Thru-hole  <b>05</b> Twisted quick connect  <b>06</b> Extended PC thru-hole  <b>17</b> Wirable quick connect</p> <p><b>Actuator Markings</b></p> <p><b>NONE</b> No marking  <b>D</b> ON-OFF  <b>H</b> O I  <b>N</b> Large dot  <b>P</b> Q –  <b>R</b> Red rectangle on end  <b>U</b> Large dot on end</p>	<p><b>Contact Material</b></p> <p><b>QA</b> Silver (UL/CSA)  <b>QF</b> Silver (UL/CSA/VDE)</p>
---	--	--



Dimensions are shown: Inches (mm)  
Specifications and dimensions subject to change



# D Series Miniature Snap-in Power Rocker Switches

## SWITCH FUNCTION

NO. POLES	MODEL NO.	AMP RATING*	SWITCH FUNCTION			CONNECTED TERMINALS			SCHEMATIC
			POS. 1	POS. 2	POS. 3	POS. 1	POS. 2	POS. 3	
SP	D102 D502	4 10	ON	NONE	OFF		N/A	OPEN	SPST
	D101 D501	4 10	ON	NONE	ON	1-1A	OPEN	1-1B	SPDT
	D103 D503	4 10		OFF					
	D105	4	MOM.	OFF	MOM.				
	D108 D508	4 10	MOM.	NONE	ON		N/A		

### SPDT

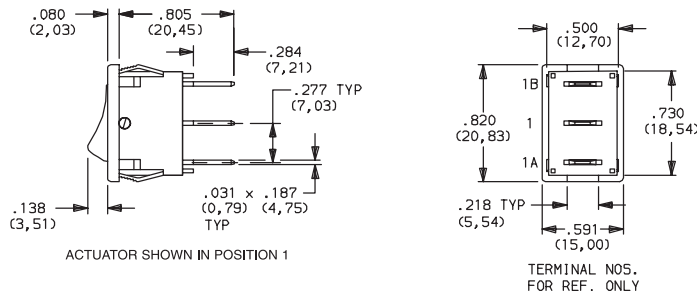

Part number shown: D101J12S215QA

DP	D202 D602	4 10	ON	NONE	OFF		N/A	OPEN	DPST
	D201 D601	4 10	ON	NONE	ON	1-1A, 2-2A	OPEN	1-1B, 2-2B	DPDT
	D203	4		OFF					
	D608	10	MOM.	NONE			N/A		

### DPDT

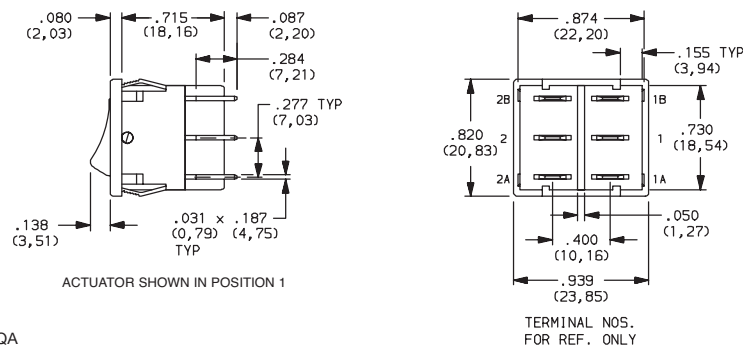

Part number shown: D201J12S215QA

MOM. = Momentary

\*AMP RATING: D10X and D20X models: 4 AMPS @ 125 V AC; 2 AMPS @ 250 V AC. D50X and D60X models: 10 AMPS @ 125 V AC; 5 AMPS @ 250 V AC.

All models . DX01, DX02 models also available with . See CONTACT MATERIALS, page G-65.

Rocker



G

**C&K**



Third Angle Projection

Dimensions are shown: Inches (mm)  
Specifications and dimensions subject to change

# D Series Miniature Snap-in Power Rocker Switches

## ACTUATOR

**J1** ROCKER

**J5** LEVER

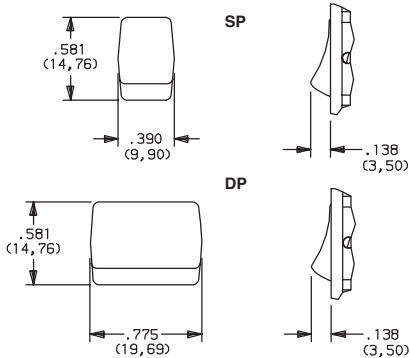

OPTION CODE	ACTUATOR COLOR
2	BLACK
1	WHITE
3	RED

**NOTE:** Actuator finish: matte. Other colors available, consult Customer Service Center.

'J5' actuator available only with DP models D201, D202, D601 and D602.

## MOUNTING STYLE/COLOR

**S** SNAP-IN

**B2** RECESSED SNAP-IN ACTUATOR GUARD, BLACK

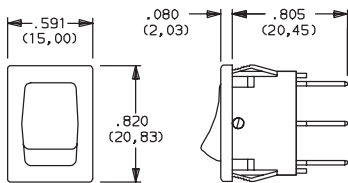

OPTION CODE	HOUSING COLOR
2	(STD.) BLACK
1	WHITE

**NOTE:** Frame finish on housing: matte. Other colors available, consult Customer Service Center.

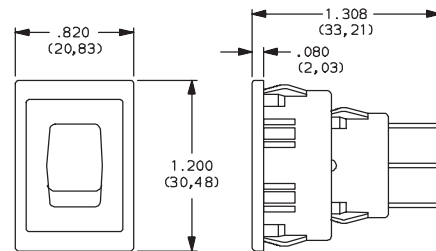

**NOTE:** Vertical mount, SP models only.

**G2** ACTUATOR GUARD, BLACK

**NEW!**

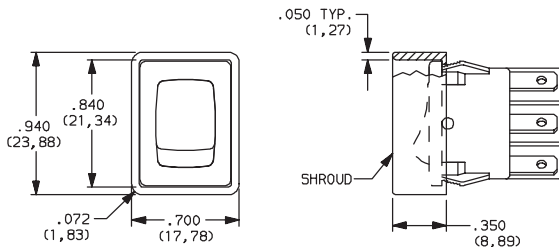

**NOTE:** Vertical mount, SP models only.

### PANEL MOUNTING

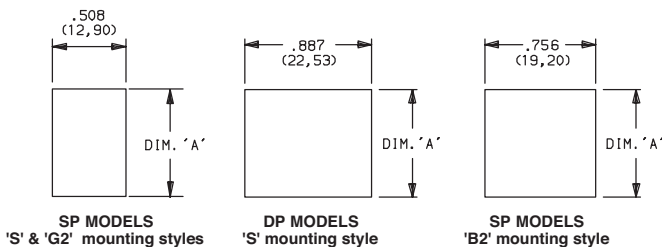

PANEL THICKNESS	DIM 'A' SP & DP MODELS 'S' MOUNTING STYLE	DIM 'A' WITH 'G2' OPTION SP MODELS ONLY	DIM 'A' SP MODELS 'B' MOUNTING STYLE
.030-.049 (0,76) (1,24)	.756 (19,20)	.764 (19,41)	1.068 (27,13)
.049-.079 (1,24) (2,01)	.764 (19,41)	.780 (19,81)	1.076 (27,33)
.079-.118 (2,01) (3,00)	.780 (19,81)	n/a	1.092 (27,74)

**NOTE:** Blank insert available for SP models only, see page G-65.



Dimensions are shown: Inches (mm)  
Specifications and dimensions subject to change



# D Series Miniature Snap-in Power Rocker Switches

## TERMINATIONS

### A RIGHT ANGLE, PC THRU-HOLE

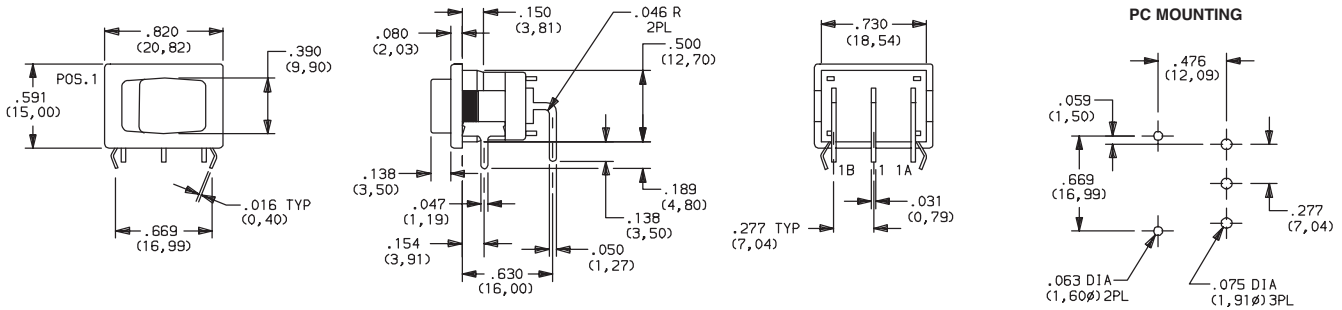

Available with D101, D102, D501, D502 SP models only.

## TERMINATIONS

### 02 PC THRU-HOLE

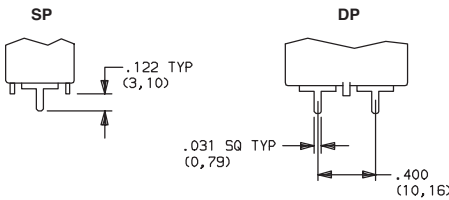

Available with DX01 and DX02 models only.

### 06 EXTENDED PC THRU-HOLE

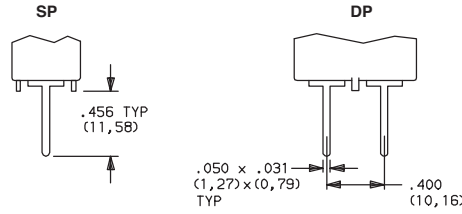

Available with DX01 and DX02 models only.

### PC MOUNTING (02 and 06)

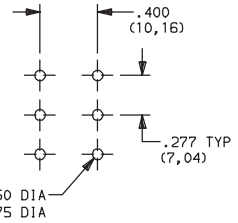

### 15 QUICK CONNECT

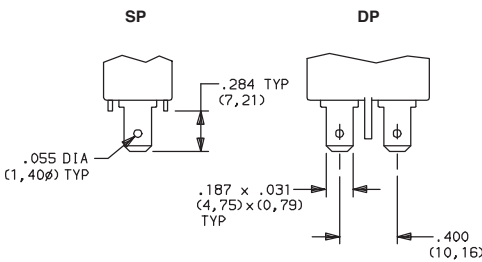

Available with DX01 and DX02 models only.

### 05 TWISTED QUICK CONNECT

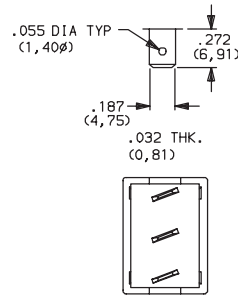

NOTE: Terminals are twisted.

### 17 WIRABLE QUICK CONNECT

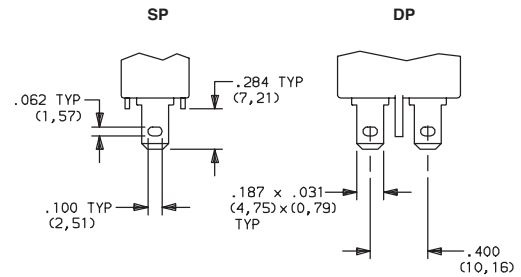

Available with DX01 and DX02 models only.

## ACTUATORS

**NONE** NO MARKING

**D** ON-OFF

**H** O |

**N** LARGE DOT

**P** O -

**R** RED RECTANGLE **U** LARGE DOT ON END ON END

Rocker

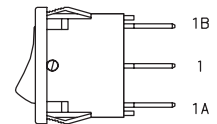

'D, H, P & U' marking options: marking color white, standard for all actuator colors except white. Black marking color, standard for white actuators. 'R' & 'N' marking option: red marking color, standard. Consult Customer Service Center for other available marking colors.

**NOTE:** Orientation of actuator markings and terminals.



Third Angle Projection

Dimensions are shown: Inches (mm)  
Specifications and dimensions subject to change







# D Series Miniature Snap-in Power Rocker Switches

## CONTACT MATERIAL

OPTION CODE	CONTACT AND TERMINAL MATERIAL	RATINGS	
QA	SILVER <sup>1</sup>	POWER	D10X and D20X MODELS: 4 AMPS @ 125 V AC; 2 AMPS @ 250 V AC (UL/CSA). D50X and D60X MODELS: 10 AMPS @ 125 V AC; 5 AMPS @ 250 V AC (UL/CSA).
QF			D10X and D20X MODELS: 4 AMPS @ 125 V AC; 2 AMPS @ 250 V AC (UL/CSA). 4(2) AMPS @ 125 V AC; 2(1) AMPS @ 250 V AC, T85 (VDE). D50X and D60X MODELS: 10 AMPS @ 125 V AC; 5 AMPS @ 250 V AC (UL/CSA). 10(6) AMPS @ 125 V AC; 5(3) AMPS @ 250 V AC, T85 (VDE).

<sup>1</sup>MOVABLE CONTACT: D10X and D20X MODELS: Copper, silver plated.  
D50X and D60X MODELS: Coin silver, silver plated.  
STATIONARY CONTACTS & TERMINALS: Copper or brass, silver plated.

All models   with all options. DX01, DX02 models    when ordered with 'QF' contact material.

## AVAILABLE HARDWARE

Insert  
SP Only

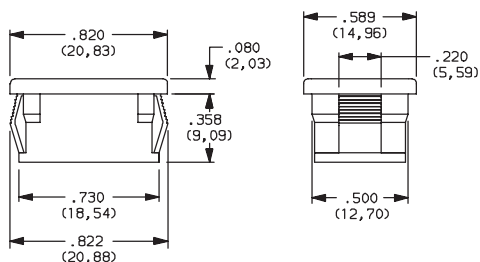

**PART NO.**  
**057190200** BLACK  
Material: Nylon 6/6  
Finish: Matte

Recessed Actuator Guard,  
SP Only



**599D02000** BLACK  
Material: 6/6 Nylon  
Finish: Matte

Actuator Guard

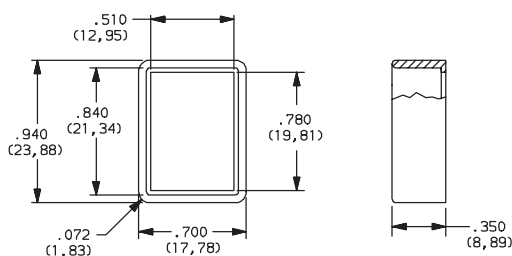

**PART NO.**  
**104C22000**  
Material: PBT thermoplastic  
Finish: Matte

**PART NO.**  
**216C00000** IP65 SPLASH PROOF RUBBER  
BOOT

