

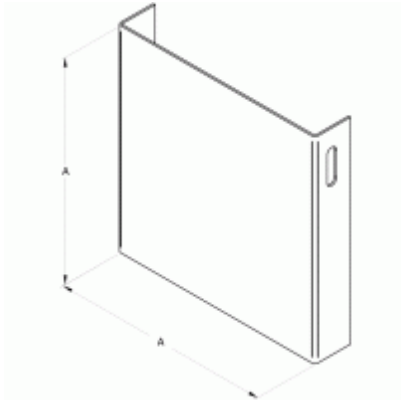

Quality Products. Service Excellence.

Closing Plate - w/o Knockouts CWCPNK Series



Painted Steel

Part No.	For use with	H	W
CWCP2NK	2.5 x 2.5	2.40	2.40
CWCP4NK	4 x 4	3.90	3.90
CWCP6NK	6 x 6	5.90	5.90
CWCP8NK	8 x 8	7.90	7.90
CWCP10NK	10 x 10	9.90	9.90
CWCP12NK	12 x 12	11.90	11.90

Unpainted Galvanized

Part No.	For use with	H	W
CWCP2GNK	2.5 x 2.5	2.40	2.40
CWCP4GNK	4 x 4	3.90	3.90
CWCP6GNK	6 x 6	5.90	5.90
CWCP8GNK	8 x 8	7.90	7.90
CWCP10GNK	10 x 10	9.90	9.90
CWCP12GNK	12 x 12	11.90	11.90

Data subject to change without notice

© 2022. Hammond Manufacturing Ltd. All rights reserved.