



Think Automation and beyond...

ø22 mm

# CW Series Flush Silhouette Switches

Double Contact Block

Double contact block

4-contact configurations available

Safety

Two-action removal

IDEC's third-generation safety construction reduces labor and enhances level of safety.

Double contact block



Only 59.9 mm behind the panel

Single contact block



Shortest in its class

Only 39.9 mm behind the panel



2.5 mm-thick bezel

Sleek design

## Ø22 mm CW Series Flush Silhouette Switches



**Double Contact Block**

**New double contact blocks with four-contact configurations.**  
(Illuminated pushbuttons, pushbuttons, selector switches, key selector switches)

Double contact blocks



Single contact blocks



**Shortest in its class**  
(as of March 2013)

**Short depth behind the panel for compact equipment.**

**Double: 59.9 mm (maintained: 64.6 mm)**

**Single: 39.9 mm (maintained: 44.6 mm)**

Switching capacity is 120V AC, 10A (resistive load). The compact style requires less depth behind the panel. Can be used with IDEC's FB and other 22 mm control boxes. No transformer needed for any voltage.

Double contact block



(Actual size)

59.9 mm

Single contact block

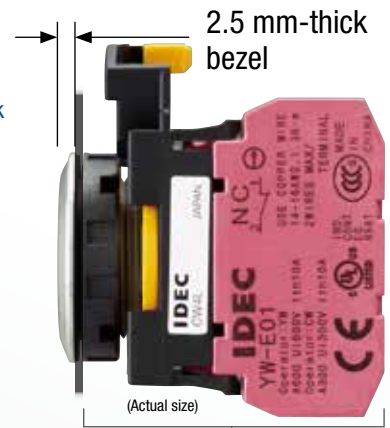

(Actual size)

39.9 mm

**Fits in small space**

*Four-contact illuminated pushbutton*

Conventional

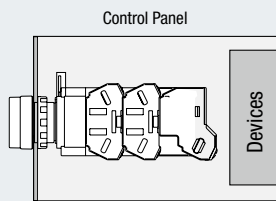

**40% less space**  
**50% less weight**

CW series double contact block



*Two-contact illuminated pushbutton*

Conventional

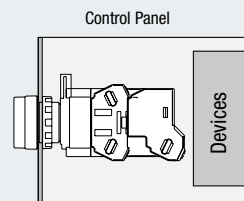

**50% less space**  
**59% less weight**

CW series single contact block

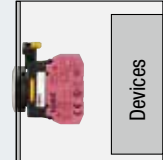



# sophistication



## Sleek and stylish switches and pilot lights with a 2.5 mm-thick bezel

The CW series gives a sleek, stylish image to your machines or control panels. The surface is safer with less chance of unexpected operation or accidents by hitting the projections, and also is cleaner with less dust build-up.



## **Safety** Third-generation safety construction

### Two-action removal of contact blocks

IDEC's original two-action push-turn locking lever provides a higher level of safety by preventing unexpected release of the locking lever. Whether the contact block is installed securely can be checked easily from the back of the panel, with the position of the locking lever.

### Locking lever integrated with guard

Prevents locking lever from unexpected release or damage by trapped wires.



### IP20 Finger-safe Terminal

Finger-safe, IP20 terminal prevents electrical shock.



## Variety



**Illuminated Pushbuttons**  
(round flush or extended)



See page 8.



**Pilot lights**  
(round flush or extended)



See page 10.



**Pushbuttons**  
(round flush or extended)



See page 11.

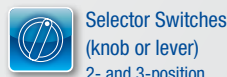

**Selector Switches**  
(knob or lever)  
2- and 3-position

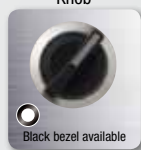

See page 12.

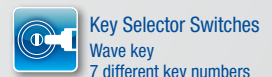

**Key Selector Switches**  
Wave key  
7 different key numbers



See page 14.



Hard to duplicate, wave-key ensures a high level of safety.

## Colors

Illuminated Pushbuttons/Pilot Lights						Pushbuttons						Bezels	
Amber (A)	Blue (S)	Green (G)	Red (R)	Pure White (PW)	Yellow (Y)	Black	Blue	Green	Red	White	Yellow	Metallic	Black (plastic)

**Flush bezel projects only 2.5 mm from front of panel  
Only 39.9 mm depth behind the panel (single contact block, momentary).**

- ø22.3 mm mounting hole compliant with IEC 60947-5-1
- 3.5-mm operator travel for pushbuttons ensures comfortable and reliable operation.
- Black plastic and metallic bezels available.
- Four-contact configuration is available with double contact blocks.
- Direct opening NC contact ensures shutdown without failure.
- Seven different keys can be chosen for key selector switches.
- 10A contact rating. Up to three contact blocks for non-illuminated and two contact blocks for illuminated units can be connected.
- Contact blocks can be removed by the two-action locking lever integrated with a guard, ensuring safety.
- IP20 finger-safe screw terminals
- IP66/67, UL Type 4X degree of protection from panel front (see Table 1).

Applicable Standards	Mark	File No. or Organization
UL508 CSA C22.2 No.14		UL/c-UL File No. E68961
EN60947-5-1		EU Low Voltage Directive
GB14048.5		No. 2012010305589209 (Pilot lights: No. 2012010304567962)



## Contact Ratings

Rated Insulation Voltage (Ui)			300V			
Rated Thermal Current (Ith)			10A			
Rated Operating Voltage (Ue)			24V	120V	240V	
Rated Operating Current (Ie)	Electrical Life 50,000 operations	AC 50/60 Hz	Resistive Load (AC-12)	10A	10A	6A
			Inductive Load (AC-15)	10A	6A	3A
		DC	Resistive Load (DC-12)	8A	2.2A	1.1A
	Inductive Load (DC-13)		4A	1.1A	0.55A	
	Electrical Life 100,000 operations	AC 50/60 Hz	Resistive Load (AC-12)	5A	5A	3A
			Inductive Load (AC-15)	5A	3A	1.5A
DC		Resistive Load (DC-12)	4A	1.1A	0.55A	
		Inductive Load (DC-13)	2A	0.55A	0.27A	
Contact Material			Silver			

- Minimum applicable load (reference value): 3V AC/DC, 5 mA (Applicable range is subject to the operating conditions and load.)
- Note: The operational current represents the classification by making and breaking currents (IEC 60947-5-1).
- UL, c-UL rating: A300, CCC rating: A300

**Table 1 (Degree of Protection)**

	IP65	IP66	IP67	UL Type 4X
Illuminated Pushbutton	Yes	Yes (Note)	Yes (Note)	Yes (Note)
Pilot Light	Yes	Yes	No	Yes
Pushbutton	Yes	Yes (Note)	Yes (Note)	Yes (Note)
Selector Switch	Yes	Yes	Yes	Yes
Key Selector Switch	Yes	Yes	No	Yes

Note: When used with rubber boot (CW9Z-D11, -D12)

## Specifications

Operating Temperature	Non-illuminated: -25 to +60°C (no freezing) LED illuminated: -25 to +55°C (no freezing)	
Operating Humidity	45 to 85% RH (no condensation)	
Storage Temperature	-40 to +80°C (no freezing)	
Contact Resistance	50 mΩ maximum (initial value)	
Insulation Resistance	100 MΩ minimum (500V DC megger)	
Overvoltage Category	II (IEC 60664-1)	
Impulse Withstand Voltage	2.5 kV (IEC 60664-1/60947-5-1)	
Pollution Degree	3 (IEC 60947-5-1)	
Vibration Resistance	Operating extremes: 5 to 55Hz, amplitude 0.5 mm Damage limits: 30 Hz, amplitude 1.5 mm	
Shock Resistance	Operating extremes: 100 m/s <sup>2</sup> Damage limits: 1000 m/s <sup>2</sup>	
Mechanical Life (minimum operations)	Illuminated pushbutton/pushbutton	
	Momentary:	2,000,000 (single contact block) 1,000,000 (double contact block)
	Maintained:	250,000 (single contact block) 100,000 (double contact block)
	Selector switch:	250,000 (single contact block) 100,000 (double contact block)
Electrical Life (minimum operations)	Key selector switch:	250,000 (single contact block) 100,000 (double contact block)
	Single contact block	50,000 (see Contact Ratings) 100,000 (see Contact Ratings)
Electrical Life (minimum operations)	Double contact block	25,000 (see Contact Ratings) 50,000 (see Contact Ratings)
	Switching frequency	
Degree of Protection (IEC 60529)	Momentary: 1800 operations/h Maintained: 900 operations/h	
	Panel front:	See table to the left
Short-circuit Protection	Terminal:	IP20 (IEC 60529)
	250V/10A fuse (Type aM IEC 60269-1, IEC 602069-2)	
Electrical Shock Protection	Class II (IEC 61140)	
Terminal Style	Screw terminal (M3.5 slotted Phillips screw) (Ring terminal cannot be used.)	
Bezel Material	Polyamide	
Applicable Wire Size	Up to 2 wires of 2 mm <sup>2</sup> (solid wire ø1.6) maximum (14 to 16AWG)	
Recommended Tightening Torque	Terminal:	1.0 to 1.3 N·m
	Locking ring:	1.2 N·m

## Weight (Examples)

Illuminated Pushbutton	46g (CW1L-M1E02QH, 2 contacts) 62g (CW1L-M1E22QH, 4 contacts)
Pilot Light	27g (CW1P-1EQH)
Pushbutton	45g (CW1B-M1E03, 3 contacts) 52g (CW1B-M1E22, 4 contacts)
Selector Switch	48g (CW1S-2E03, 3 contacts) 55g (CW1S-2E22, 4 contacts)
Key Selector Switch	61g (CW1K-2AE03, 3 contacts) 68g (CW1K-2AE22, 4 contacts)

## Direct Opening of Key Selector Switch

Applicable Type	2-position (3NC)	3-position (2NC)
Minimum Operator Angle for Direct Opening Action	90°	45°
Minimum Operator Torque for Direct Opening Action	0.2 N·m	0.3 N·m
Maximum Operator Angle	90°	45°

## LED Module

Rated Insulation Voltage (Ui)	250V					
Rated Operating Voltage (Ue)	6V AC/DC	12V AC/DC	24V AC/DC	100/120V AC (50/60 Hz sine wave)	200/220V AC (50/60 Hz sine wave)	230/240V AC (50/60 Hz sine wave)
Operating Voltage Range	6V AC/DC ±10%	12V AC/DC ±10%	24V AC/DC ±10%	100/120V AC ±10%	200/220V AC ±10%	230/240V AC ±10%
Illumination Color Code ②	A (amber), G (green), PW (pure white), R (red), S (blue)					
LED Module Part No.	CW-EAQ2②	CW-EAQ3②	CW-EAQ4②	CW-EAQH②	CW-EAQM②	CW-EAQM4②
Current Draw	15 mA	15 mA	16.5 mA	18 mA	20 mA	18 mA
Life (reference value)	Approx. 30,000 hours (the illuminance is reduced to 50% of the initial intensity when used on complete DC at 25°C.)					
Internal Circuit	<ul style="list-style-type: none"> <li> LED Chip</li> <li> Rectifying Diode</li> <li> Zener Diode</li> <li> Resistor</li> </ul>			<ul style="list-style-type: none"> <li> LED Chip</li> <li> Rectifying Diode</li> <li> Zener Diode</li> <li> Resistor</li> <li> Capacitor</li> </ul>		

- Specify an illumination color code in place of ② in the Part No.
- Use the pure white (PW) LED module for yellow illumination.

## Contact Blocks

Contact	Single Contact Block		Double Contact Block		
	1NO	1NC	2NO	2NC	1NO-1NC
Part No.	YW-E10R	YW-E01	YW-EW2R0	YW-EW02	YW-EW1R1
Shape					
Housing Color	Blue/Black	Reddish Purple	Blue/Black	Reddish Purple	Reddish Purple/Blue
Push Rod Color	Black	Red	Black	Red	Gray
Terminal No.	3-4	1-2	1st tier: 13-14 2nd tier: 23-24	1st tier: 11-12 2nd tier: 21-22	1st tier: (NO) 13-14 2nd tier: (NC) 21-22
Weight (approx.)	11g		19g		

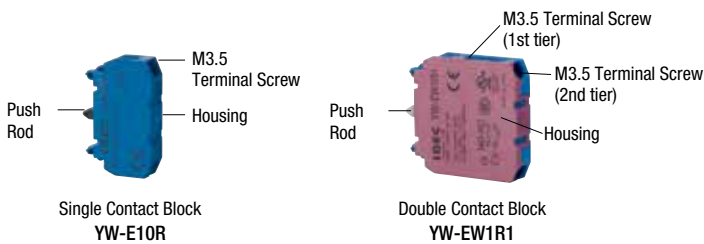

## Mounting Hole Layout

IEC 60947-5-1 compliant

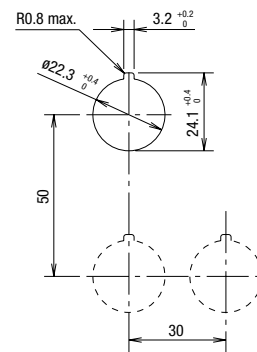

Note: Determine mounting centers to ensure easy operation.

# ø22 Flush Silhouette Switches CW Series

## Part No. Development

### Illuminated Pushbuttons

Note: Please use these charts to interpret the part numbers as all combinations are not possible to be created.

C W 1 L - M 1 E 10 Q4 ②

#### Bezel Color

Code	Bezel Color
1	Black
4	Metallic

#### Operation

Code	Operation
M	Momentary
A	Maintained

#### Shape

Code	Shape
1	Round Flush
2	Round Extended

#### Option

Code	Option	Part No. Example
W	White lens type (when light is off)	CW1L-M1E10Q4W②

- For white lens, clear lens is used instead of colored lens for amber, green, red, and blue illuminated pushbuttons. Amber, green, red, or blue LED units are used.

#### Illumination Color

Code	Color	Code	Color
A	Amber	R	Red
G	Green	S	Blue
PW	Pure White	Y	Yellow

#### Rated Voltage

Code	Rated Voltage	Code	Rated Voltage
Q2	6V AC/DC	QH	100/120V AC
Q3	12V AC/DC	QM	200/220V AC
Q4	24V AC/DC	QM4	230/240V AC

#### Contact Configuration

Code	Contact Configuration	Code	Contact Configuration
10	1NO	20	2NO
01	1NC	02	2NC
11	1NO-1NC	22	2NO-2NC

### Pilot Lights

C W 1 P - 1 E Q4 ②

#### Bezel Color

Code	Bezel Color
1	Black
4	Metallic

#### Shape

Code	Shape
1	Round Flush
2	Round Extended

#### Option

Code	Option	Part No. Example
W	White lens type (when light is off)	CW1P-1EQ4W②

- For white lens, clear lens is used instead of colored lens for amber, green, red, and blue illuminated pushbuttons. Amber, green, red, or blue LED units are used.

#### Illumination Color

Code	Color	Code	Color
A	Amber	R	Red
G	Green	S	Blue
PW	Pure White	Y	Yellow

#### Rated Voltage

Code	Rated Voltage	Code	Rated Voltage
Q2	6V AC/DC	QH	100/120V AC
Q3	12V AC/DC	QM	200/220V AC
Q4	24V AC/DC	QM4	230/240V AC

### Pushbuttons

C W 1 B - M 1 E 10 ①

#### Bezel Color

Code	Bezel Color
1	Black
4	Metallic

#### Operation

Code	Operation
M	Momentary
A	Maintained

#### Operation

Code	Shape
1	Round Flush
2	Round Extended

#### Button Color

Code	Color	Code	Color
A	Amber	R	Red
B	Black	S	Blue
G	Green	Y	Yellow

#### Contact Configuration

Code	Contact Configuration	Code	Contact Configuration
10	1NO	02	2NC
01	1NC	21	2NO-1NC
11	1NO-1NC	22	2NO-2NC
12	1NO-2NC	30	3NO
20	2NO	03	3NC

**Selector Switches**

**CW 1 S - 2 LE 10**

**Bezel Color**

Code	Bezel Color
1	Black
4	Metallic

**Contact Configuration**  
See page 12 and 13.

**Operator**

Code	Shape
Blank	Knob
L	Lever

**Positions**

**2-position**

Code	Position	Code	Positions
2	Maintained 	21	Spring return from right 

**3-position**

Code	Position	Code	Positions	Code	Position	Code	Positions
3	Maintained 	31	Spring return from right 	32	Spring return from left 	33	Spring return two-way 

**Key Selector Switches**

**CW 1 K - 2 A E 10 - 1H**

**Bezel Color**

Code	Bezel Color
1	Black
4	Metallic

**Key**

Code	Bezel Color
Blank	Standard
1H to 2H	Reversible Key
3H to 6H	Non-reversible Key

**Contact Configuration**  
See page 14 and 15.

**Positions**

Code	Bezel Color
2	90° 2-position, maintained
21	90° 2-position, spring return from right
3	45° 3-position, maintained
31	45° 3-position, spring return from right
32	45° 3-position, spring return from left
33	45° 3-position, spring return two-way

**Key Removal Position**

**2-position**

Code	Position	Code	Positions	Code	Positions	Spring Return from right
A	Maintained 	B	Removable in left only 	C	Removable in right only 	

①②: Key retained position

Note: The key cannot be removed in a spring return position.

**3-position**

Code	Position	Code	Positions	Code	Positions	Code	Positions
A	Maintained 	B	Removable in left and center 	C	Removable in right and center 	D	Removable in center only 
E	Maintained (removable in right and left) 	G	Removable in left only 	H	Removable in right only 		

①②: Key retained position

Spring Return from right	Spring Return from left	Spring Return two-way



Note: The key cannot be removed in a spring return position.



# ø22 Flush Silhouette Switches CW Series Illuminated Pushbuttons

## Illuminated Pushbuttons

Package quantity: 1

Shape	Operation	Operating Voltage	Contact Configuration	Part No.		Illumination Color Code ②	
				Black Bezel	Metallic Bezel		
Round Flush CW□L-M1 CW□L-A1   (black bezel)   (metallic bezel)	Momentary	6V AC/DC	1NO	CW1L-M1E10Q2②	CW4L-M1E10Q2②	Specify an illumination color code in place of ② in the Part No.  A: amber G: green PW: pure white R: red S: blue Y: yellow	
			1NC	CW1L-M1E01Q2②	CW4L-M1E01Q2②		
			1NO-1NC	CW1L-M1E11Q2②	CW4L-M1E11Q2②		
			2NO	CW1L-M1E20Q2②	CW4L-M1E20Q2②		
			2NC	CW1L-M1E02Q2②	CW4L-M1E02Q2②		
			2NO-2NC	CW1L-M1E22Q2②	CW4L-M1E22Q2②		
		12V AC/DC	1NO	CW1L-M1E10Q3②	CW4L-M1E10Q3②		
			1NC	CW1L-M1E01Q3②	CW4L-M1E01Q3②		
			1NO-1NC	CW1L-M1E11Q3②	CW4L-M1E11Q3②		
			2NO	CW1L-M1E20Q3②	CW4L-M1E20Q3②		
			2NC	CW1L-M1E02Q3②	CW4L-M1E02Q3②		
			2NO-2NC	CW1L-M1E22Q3②	CW4L-M1E22Q3②		
		24V AC/DC	1NO	CW1L-M1E10Q4②	CW4L-M1E10Q4②		
			1NC	CW1L-M1E01Q4②	CW4L-M1E01Q4②		
			1NO-1NC	CW1L-M1E11Q4②	CW4L-M1E11Q4②		
			2NO	CW1L-M1E20Q4②	CW4L-M1E20Q4②		
			2NC	CW1L-M1E02Q4②	CW4L-M1E02Q4②		
			2NO-2NC	CW1L-M1E22Q4②	CW4L-M1E22Q4②		
		100/120V AC	1NO	CW1L-M1E10QH②	CW4L-M1E10QH②		
			1NC	CW1L-M1E01QH②	CW4L-M1E01QH②		
			1NO-1NC	CW1L-M1E11QH②	CW4L-M1E11QH②		
			2NO	CW1L-M1E20QH②	CW4L-M1E20QH②		
			2NC	CW1L-M1E02QH②	CW4L-M1E02QH②		
			2NO-2NC	CW1L-M1E22QH②	CW4L-M1E22QH②		
	200/220V AC	1NO	CW1L-M1E10QM②	CW4L-M1E10QM②			
		1NC	CW1L-M1E01QM②	CW4L-M1E01QM②			
		1NO-1NC	CW1L-M1E11QM②	CW4L-M1E11QM②			
		2NO	CW1L-M1E20QM②	CW4L-M1E20QM②			
		2NC	CW1L-M1E02QM②	CW4L-M1E02QM②			
		2NO-2NC	CW1L-M1E22QM②	CW4L-M1E22QM②			
	230/240V AC	1NO	CW1L-M1E10QM4②	CW4L-M1E10QM4②			
		1NC	CW1L-M1E01QM4②	CW4L-M1E01QM4②			
		1NO-1NC	CW1L-M1E11QM4②	CW4L-M1E11QM4②			
		2NO	CW1L-M1E20QM4②	CW4L-M1E20QM4②			
		2NC	CW1L-M1E02QM4②	CW4L-M1E02QM4②			
		2NO-2NC	CW1L-M1E22QM4②	CW4L-M1E22QM4②			
	Maintained	6V AC/DC	1NO	CW1L-A1E10Q2②	CW4L-A1E10Q2②		Specify an illumination color code in place of ② in the Part No.  A: amber G: green PW: pure white R: red S: blue Y: yellow
			1NC	CW1L-A1E01Q2②	CW4L-A1E01Q2②		
			1NO-1NC	CW1L-A1E11Q2②	CW4L-A1E11Q2②		
			2NO	CW1L-A1E20Q2②	CW4L-A1E20Q2②		
			2NC	CW1L-A1E02Q2②	CW4L-A1E02Q2②		
			2NO-2NC	CW1L-A1E22Q2②	CW4L-A1E22Q2②		
		12V AC/DC	1NO	CW1L-A1E10Q3②	CW4L-A1E10Q3②		
			1NC	CW1L-A1E01Q3②	CW4L-A1E01Q3②		
			1NO-1NC	CW1L-A1E11Q3②	CW4L-A1E11Q3②		
			2NO	CW1L-A1E20Q3②	CW4L-A1E20Q3②		
			2NC	CW1L-A1E02Q3②	CW4L-A1E02Q3②		
			2NO-2NC	CW1L-A1E22Q3②	CW4L-A1E22Q3②		
24V AC/DC		1NO	CW1L-A1E10Q4②	CW4L-A1E10Q4②			
		1NC	CW1L-A1E01Q4②	CW4L-A1E01Q4②			
		1NO-1NC	CW1L-A1E11Q4②	CW4L-A1E11Q4②			
		2NO	CW1L-A1E20Q4②	CW4L-A1E20Q4②			
		2NC	CW1L-A1E02Q4②	CW4L-A1E02Q4②			
		2NO-2NC	CW1L-A1E22Q4②	CW4L-A1E22Q4②			
100/120V AC		1NO	CW1L-A1E10QH②	CW4L-A1E10QH②			
		1NC	CW1L-A1E01QH②	CW4L-A1E01QH②			
		1NO-1NC	CW1L-A1E11QH②	CW4L-A1E11QH②			
		2NO	CW1L-A1E20QH②	CW4L-A1E20QH②			
		2NC	CW1L-A1E02QH②	CW4L-A1E02QH②			
		2NO-2NC	CW1L-A1E22QH②	CW4L-A1E22QH②			
200/220V AC	1NO	CW1L-A1E10QM②	CW4L-A1E10QM②				
	1NC	CW1L-A1E01QM②	CW4L-A1E01QM②				
	1NO-1NC	CW1L-A1E11QM②	CW4L-A1E11QM②				
	2NO	CW1L-A1E20QM②	CW4L-A1E20QM②				
	2NC	CW1L-A1E02QM②	CW4L-A1E02QM②				
	2NO-2NC	CW1L-A1E22QM②	CW4L-A1E22QM②				
230/240V AC	1NO	CW1L-A1E10QM4②	CW4L-A1E10QM4②				
	1NC	CW1L-A1E01QM4②	CW4L-A1E01QM4②				
	1NO-1NC	CW1L-A1E11QM4②	CW4L-A1E11QM4②				
	2NO	CW1L-A1E20QM4②	CW4L-A1E20QM4②				
	2NC	CW1L-A1E02QM4②	CW4L-A1E02QM4②				
	2NO-2NC	CW1L-A1E22QM4②	CW4L-A1E22QM4②				

- See page 21 for replacement LED modules.
- Marking film can be inserted to indicate legends. See page 23.
- See page 16 for dimensions.
- White lens type (when light is off) are available. Clear lens is used instead of colored lens for amber, green, red, and blue illuminated pushbuttons. Amber, green, red, or blue LED units are used. To specify, add W before the color code in Part No. Example: CW1L-M1E10Q2WR
- A dummy block is installed when one contact block is used.





## Illuminated Pushbuttons

Package quantity: 1

Shape	Operation	Operating Voltage	Contact Configuration	Part No.		Illumination Color Code ②					
				Black Bezel	Metallic Bezel						
<div style="display: flex; flex-direction: column; align-items: center;"> <p>(black bezel)</p> <p>(metallic bezel)</p> </div>	Momentary	6V AC/DC	1NO	CW1L-M2E10Q2②	CW4L-M2E10Q2②	Specify an illumination color code in place of ② in the Part No.  A: amber G: green PW: pure white R: red S: blue Y: yellow					
			1NC	CW1L-M2E01Q2②	CW4L-M2E01Q2②						
			1NO-1NC	CW1L-M2E11Q2②	CW4L-M2E11Q2②						
			2NO	CW1L-M2E20Q2②	CW4L-M2E20Q2②						
			2NC	CW1L-M2E02Q2②	CW4L-M2E02Q2②						
			2NO-2NC	CW1L-M2E22Q2②	CW4L-M2E22Q2②						
			12V AC/DC	1NO	CW1L-M2E10Q3②		CW4L-M2E10Q3②				
				1NC	CW1L-M2E01Q3②		CW4L-M2E01Q3②				
				1NO-1NC	CW1L-M2E11Q3②		CW4L-M2E11Q3②				
				2NO	CW1L-M2E20Q3②		CW4L-M2E20Q3②				
				2NC	CW1L-M2E02Q3②		CW4L-M2E02Q3②				
				2NO-2NC	CW1L-M2E22Q3②		CW4L-M2E22Q3②				
				24V AC/DC	1NO		CW1L-M2E10Q4②	CW4L-M2E10Q4②			
					1NC		CW1L-M2E01Q4②	CW4L-M2E01Q4②			
					1NO-1NC		CW1L-M2E11Q4②	CW4L-M2E11Q4②			
		2NO			CW1L-M2E20Q4②		CW4L-M2E20Q4②				
		2NC			CW1L-M2E02Q4②		CW4L-M2E02Q4②				
		2NO-2NC			CW1L-M2E22Q4②		CW4L-M2E22Q4②				
		100/120V AC			1NO		CW1L-M2E10QH②	CW4L-M2E10QH②			
					1NC		CW1L-M2E01QH②	CW4L-M2E01QH②			
					1NO-1NC		CW1L-M2E11QH②	CW4L-M2E11QH②			
			2NO		CW1L-M2E20QH②		CW4L-M2E20QH②				
			2NC		CW1L-M2E02QH②		CW4L-M2E02QH②				
			2NO-2NC		CW1L-M2E22QH②		CW4L-M2E22QH②				
			200/220V AC		1NO		CW1L-M2E10QM②	CW4L-M2E10QM②			
					1NC		CW1L-M2E01QM②	CW4L-M2E01QM②			
					1NO-1NC		CW1L-M2E11QM②	CW4L-M2E11QM②			
				2NO	CW1L-M2E20QM②		CW4L-M2E20QM②				
				2NC	CW1L-M2E02QM②		CW4L-M2E02QM②				
				2NO-2NC	CW1L-M2E22QM②		CW4L-M2E22QM②				
				230/240V AC	1NO		CW1L-M2E10QM4②	CW4L-M2E10QM4②			
					1NC		CW1L-M2E01QM4②	CW4L-M2E01QM4②			
					1NO-1NC		CW1L-M2E11QM4②	CW4L-M2E11QM4②			
		2NO			CW1L-M2E20QM4②		CW4L-M2E20QM4②				
		2NC			CW1L-M2E02QM4②		CW4L-M2E02QM4②				
		2NO-2NC			CW1L-M2E22QM4②		CW4L-M2E22QM4②				
		Maintained			Maintained		6V AC/DC	1NO	CW1L-A2E10Q2②	CW4L-A2E10Q2②	Specify an illumination color code in place of ② in the Part No.  A: amber G: green PW: pure white R: red S: blue Y: yellow
								1NC	CW1L-A2E01Q2②	CW4L-A2E01Q2②	
								1NO-1NC	CW1L-A2E11Q2②	CW4L-A2E11Q2②	
			2NO					CW1L-A2E20Q2②	CW4L-A2E20Q2②		
			2NC					CW1L-A2E02Q2②	CW4L-A2E02Q2②		
			2NO-2NC					CW1L-A2E22Q2②	CW4L-A2E22Q2②		
			12V AC/DC					1NO	CW1L-A2E10Q3②	CW4L-A2E10Q3②	
								1NC	CW1L-A2E01Q3②	CW4L-A2E01Q3②	
								1NO-1NC	CW1L-A2E11Q3②	CW4L-A2E11Q3②	
				2NO				CW1L-A2E20Q3②	CW4L-A2E20Q3②		
				2NC				CW1L-A2E02Q3②	CW4L-A2E02Q3②		
				2NO-2NC				CW1L-A2E22Q3②	CW4L-A2E22Q3②		
24V AC/DC	1NO			CW1L-A2E10Q4②		CW4L-A2E10Q4②					
	1NC			CW1L-A2E01Q4②		CW4L-A2E01Q4②					
	1NO-1NC			CW1L-A2E11Q4②		CW4L-A2E11Q4②					
	2NO			CW1L-A2E20Q4②		CW4L-A2E20Q4②					
	2NC			CW1L-A2E02Q4②		CW4L-A2E02Q4②					
	2NO-2NC			CW1L-A2E22Q4②		CW4L-A2E22Q4②					
	100/120V AC			1NO		CW1L-A2E10QH②	CW4L-A2E10QH②				
				1NC		CW1L-A2E01QH②	CW4L-A2E01QH②				
				1NO-1NC		CW1L-A2E11QH②	CW4L-A2E11QH②				
			2NO	CW1L-A2E20QH②		CW4L-A2E20QH②					
			2NC	CW1L-A2E02QH②		CW4L-A2E02QH②					
			2NO-2NC	CW1L-A2E22QH②		CW4L-A2E22QH②					
			200/220V AC	1NO		CW1L-A2E10QM②	CW4L-A2E10QM②				
				1NC		CW1L-A2E01QM②	CW4L-A2E01QM②				
				1NO-1NC		CW1L-A2E11QM②	CW4L-A2E11QM②				
2NO				CW1L-A2E20QM②		CW4L-A2E20QM②					
2NC				CW1L-A2E02QM②		CW4L-A2E02QM②					
2NO-2NC				CW1L-A2E22QM②		CW4L-A2E22QM②					
230/240V AC				1NO		CW1L-A2E10QM4②	CW4L-A2E10QM4②				
				1NC		CW1L-A2E01QM4②	CW4L-A2E01QM4②				
				1NO-1NC		CW1L-A2E11QM4②	CW4L-A2E11QM4②				
	2NO			CW1L-A2E20QM4②		CW4L-A2E20QM4②					
	2NC			CW1L-A2E02QM4②		CW4L-A2E02QM4②					
	2NO-2NC			CW1L-A2E22QM4②		CW4L-A2E22QM4②					

- See page 21 for replacement LED modules.
- Marking film can be inserted to indicate legends. See page 23.
- See page 16 for dimensions.
- White lens type (when light is off) are available. Clear lens is used instead of colored lens for amber, green, red, and blue illuminated pushbuttons. Amber, green, red, or blue LED units are used. To specify, add W before the color code in Part Number. Example: CW1L-M2E10Q2WR
- A dummy block is installed when one contact block is used.



# ø22 Flush Silhouette Switches CW series Pilot Lights

## Pilot Lights





Package quantity: 1

Shape	Operating Voltage	Part No.		Illumination Color Code ②
		Black Bezel	Metallic Bezel	
Round Flush CW□P-1  (black bezel)  (metallic bezel) 	6V AC/DC	CW1P-1EQ2②	CW4P-1EQ2②	A: amber G: green PW: pure white R: red S: blue Y: yellow
	12V AC/DC	CW1P-1EQ3②	CW4P-1EQ3②	
	24V AC/DC	CW1P-1EQ4②	CW4P-1EQ4②	
	100/120V AC	CW1P-1EQH②	CW4P-1EQH②	
	200/220V AC	CW1P-1EQM②	CW4P-1EQM②	
	230/240V AC	CW1P-1EQM4②	CW4P-1EQM4②	
Round Extended CW□P-2  (black bezel)  (metallic bezel) 	6V AC/DC	CW1P-2EQ2②	CW4P-2EQ2②	A: amber G: green PW: pure white R: red S: blue Y: yellow
	12V AC/DC	CW1P-2EQ3②	CW4P-2EQ3②	
	24V AC/DC	CW1P-2EQ4②	CW4P-2EQ4②	
	100/120V AC	CW1P-2EQH②	CW4P-2EQH②	
	200/220V AC	CW1P-2EQM②	CW4P-2EQM②	
	230/240V AC	CW1P-2EQM4②	CW4P-2EQM4②	

- Specify an illumination color code in place of ② in the Part No.
- See page 16 for dimensions.
- See page 21 for replacement LED modules.
- Two dummy blocks are installed.

## Pushbuttons

Package quantity: 1

Shape	Operation	Contact Configuration	Part No.		Button Color Code ①
			Black Bezel	Metallic Bezel	
Round Flush CW□B-M1 CW□B-A1   (black bezel)   (metallic bezel)  	Momentary	1NO	CW1B-M1E10①	CW4B-M1E10①	B: black G: green R: red S: blue W: white Y: yellow
		1NC	CW1B-M1E01①	CW4B-M1E01①	
		1NO-1NC	CW1B-M1E11①	CW4B-M1E11①	
		2NO	CW1B-M1E20①	CW4B-M1E20①	
		2NC	CW1B-M1E02①	CW4B-M1E02①	
		2NO-1NC	CW1B-M1E21①	CW4B-M1E21①	
		1NO-2NC	CW1B-M1E12①	CW4B-M1E12①	
		3NO	CW1B-M1E30①	CW4B-M1E30①	
		3NC	CW1B-M1E03①	CW4B-M1E03①	
	Maintained	1NO	CW1B-A1E10①	CW4B-A1E10①	B: black G: green R: red S: blue W: white Y: yellow
		1NC	CW1B-A1E01①	CW4B-A1E01①	
		1NO-1NC	CW1B-A1E11①	CW4B-A1E11①	
		2NO	CW1B-A1E20①	CW4B-A1E20①	
		2NC	CW1B-A1E02①	CW4B-A1E02①	
		2NO-1NC	CW1B-A1E21①	CW4B-A1E21①	
		1NO-2NC	CW1B-A1E12①	CW4B-A1E12①	
		3NO	CW1B-A1E30①	CW4B-A1E30①	
		3NC	CW1B-A1E03①	CW4B-A1E03①	
2NO-2NC	CW1B-A1E22①	CW4B-A1E22①			
Round Extended CW□B-M2 CW□B-A2   (black bezel)   (metallic bezel)  	Momentary	1NO	CW1B-M2E10①	CW4B-M2E10①	B: black G: green R: red S: blue W: white Y: yellow
		1NC	CW1B-M2E01①	CW4B-M2E01①	
		1NO-1NC	CW1B-M2E11①	CW4B-M2E11①	
		2NO	CW1B-M2E20①	CW4B-M2E20①	
		2NC	CW1B-M2E02①	CW4B-M2E02①	
		2NO-1NC	CW1B-M2E21①	CW4B-M2E21①	
		1NO-2NC	CW1B-M2E12①	CW4B-M2E12①	
		3NO	CW1B-M2E30①	CW4B-M2E30①	
		3NC	CW1B-M2E03①	CW4B-M2E03①	
	Maintained	2NO-2NC	CW1B-M2E22①	CW4B-M2E22①	B: black G: green R: red S: blue W: white Y: yellow
		1NO	CW1B-A2E10①	CW4B-A2E10①	
		1NC	CW1B-A2E01①	CW4B-A2E01①	
		1NO-1NC	CW1B-A2E11①	CW4B-A2E11①	
		2NO	CW1B-A2E20①	CW4B-A2E20①	
		2NC	CW1B-A2E02①	CW4B-A2E02①	
		2NO-1NC	CW1B-A2E21①	CW4B-A2E21①	
		1NO-2NC	CW1B-A2E12①	CW4B-A2E12①	
		3NO	CW1B-A2E30①	CW4B-A2E30①	
3NC	CW1B-A2E03①	CW4B-A2E03①			
2NO-2NC	CW1B-A2E22①	CW4B-A2E22①			

- Specify a button color code in place of ① in the Part No.
- See page 17 for dimensions.
- Two or one dummy block is installed when one or two contact blocks are used, respectively.
- Contact configurations 2NO-1NC, 1NO-2C, 3NO, and 3NC are available for momentary pushbuttons only.

# ø22 Flush Silhouette Switches CW series Selector Switches

## Selector Switches

Package quantity: 1

No. of Positions	Contact Configuration (Code)	Contact Block		Operator Position			
		Mounting Position	Contact	L	R		
90° 2-position	1NO (10)	1	NO		●	CW□S-2E10	CW□S-21E10
		2	—	Dummy			
		3	—	Dummy			
	1NC (01)	1	—	Dummy		CW□S-2E01	CW□S-21E01
		2	—	Dummy			
		3	NC	●			
	1NO-1NC (11)	1	NO		●	CW□S-2E11	CW□S-21E11
		2	—	Dummy			
		3	NC	●			
	2NO (20)	1	NO		●	CW□S-2E20	CW□S-21E20
		2	—	Dummy			
		3	NO		●		
	2NC (02)	1	NC	●		CW□S-2E02	CW□S-21E02
		2	—	Dummy			
		3	NC	●			
	2NO-1NC (21)	1	NO		●	CW□S-2E21	CW□S-21E21
		2	NO		●		
		3	NC	●			
	1NO-2NC (12)	1	NO		●	CW□S-2E12	CW□S-21E12
		2	NC	●			
		3	NC	●			
	3NO (30)	1	NO		●	CW□S-2E30	CW□S-21E30
		2	NO		●		
		3	NO		●		
	3NC (03)	1	NC	●		CW□S-2E03	CW□S-21E03
		2	NC	●			
		3	NC	●			
	2NO-2NC (22)	1	NO/NC	NO NC	●	CW□S-2E22	CW□S-21E22
2		—	Dummy				
3		NO/NC	NO NC	●			
4NO (40)	1	2NO	NO NO	● ●	CW□S-21E40	CW□S-21E40	
	2	—	Dummy				
	3	2NO	NO NO	● ●			

- Specify a bezel color code in place of □ in the Part No.: 1 (black bezel), 4 (metallic bezel)
- Lever operator is also available. For dimensions, see page 18.
- When ordering a lever operator selector switch, designate L before E in the Part No. of knob operator selector switches.

[Example] CW1S-2E10 → CW1S-2LE10

Knob Operator

Lever Operator

Contact Block Mounting Position

1 2 3

Lever Operator



CW1S-\*LE (black bezel)







CW4S-\*LE (metallic bezel)





# Flush Silhouette Switches CW series Selector Switches ø22

Package quantity: 1

No. of Positions	Contact Configuration (Code)	Contact Block		Operator Position			 Maintained	 Spring return from right	 Spring return from left	 Spring return two-way	
		Mounting Position	Contact	L	C	R					
45° 3-position	1NO-1NC (11)	1	NO	●			CW□S-3E11	CW□S-31E11	CW□S-32E11	CW□S-33E11	
		2	—	Dummy							
		3	NC	■							
	1NO-1NC (11N1)	1	NC		■			CW□S-3E11N1	CW□S-31E11N1	CW□S-32E11N1	CW□S-33E11N1
		2	—	Dummy							
		3	NO			●					
	1NO-1NC (11N2)	1	NO	●			CW□S-3E11N2	CW□S-31E11N2	CW□S-32E11N2	CW□S-33E11N2	
		2	NC			●					
		3	—	Dummy							
	1NO-1NC (11N3)	1	—	Dummy			CW□S-3E11N3	CW□S-31E11N3	CW□S-32E11N3	CW□S-33E11N3	
		2	NC			●					
		3	NO			●					
	1NO-1NC (11N4)	1	—	Dummy			CW□S-3E11N4	CW□S-31E11N4	CW□S-32E11N4	CW□S-33E11N4	
		2	NO	●		●					
		3	NC	■							
	2NO (20)	1	NO	●			CW□S-3E20	CW□S-31E20	CW□S-32E20	CW□S-33E20	
		2	—	Dummy							
		3	NO			●					
	2NO (20N1)	1	—	Dummy			CW□S-3E20N1	CW□S-31E20N1	CW□S-32E20N1	CW□S-33E20N1	
		2	NO	●		●					
		3	NO			●					
	2NC (02)	1	NC		■			CW□S-3E02	CW□S-31E02	CW□S-32E02	CW□S-33E02
		2	—	Dummy							
		3	NC	■							
	2NC (02N1)	1	—	Dummy			CW□S-3E02N1	CW□S-31E02N1	CW□S-32E02N1	CW□S-33E02N1	
		2	NC			●					
		3	NC	■							
	2NO-1NC (21)	1	NO	●			CW□S-3E21	CW□S-31E21	CW□S-32E21	CW□S-33E21	
		2	NO	●		●					
		3	NC	■							
	2NO-1NC (21N1)	1	NO	●			CW□S-3E21N1	CW□S-31E21N1	CW□S-32E21N1	CW□S-33E21N1	
		2	NC			●					
		3	NO			●					
	1NO-2NC (12)	1	NO	●			CW□S-3E12	CW□S-31E12	CW□S-32E12	CW□S-33E12	
		2	NC			●					
		3	NC	■							
	1NO-2NC (12N1)	1	NC		■			CW□S-3E12N1	CW□S-31E12N1	CW□S-32E12N1	CW□S-33E12N1
		2	NO	●		●					
		3	NC	■							
	3NO (30)	1	NO	●			CW□S-3E30	CW□S-31E30	CW□S-32E30	CW□S-33E30	
2		NO	●		●						
3		NO			●						
3NC (03)	1	NC		■			CW□S-3E03	CW□S-31E03	CW□S-32E03	CW□S-33E03	
	2	NC			●						
	3	NC	■								
2NO-2NC (22)	1	NO/NC	NO	●		CW□S-3E22	CW□S-31E22	CW□S-32E22	CW□S-33E22		
	2	—	Dummy								
	3	NO/NC	NO	●							
4NO (40)	1	2NO	NO	●		CW□S-3E40	CW□S-31E40	CW□S-32E40	CW□S-33E40		
	2	—	Dummy								
	3	2NO	NO		●						
2NO-2NC (22N2)	1	2NC	NC		■		CW□S-3E22N2	CW□S-31E22N2	CW□S-32E22N2	CW□S-33E22N2	
	2	—	Dummy								
	3	2NO	NC		●						

• Specify a bezel color code in place of □ in the Part No.: 1 (black bezel), 4 (metallic bezel) • For the contact block mounting position, see page 12.

• Lever operator is also available. For dimensions, see page 18.

• When ordering a lever operator selector switch, designate L before E in the Part No. of knob operator selector switches.

[Example] CW1S-3E11 → CW1S-3LE11

Knob Operator    Lever Operator

# ø22 Flush Silhouette Switches CW series Key Selector Switches

## Key Selector Switches

Package quantity: 1

No. of Positions	Contact Configuration (Code)	Contact Block		Operator Position		 Maintained	 Spring return from right	
		Mounting Position	Contact	L	R			
90° 2-position	1NO (10)	1	NO		I	CW□K-2AE10	CW□K-21BE10	
		2	—	Dummy				
		3	—	Dummy				
	1NC (01)	1	—	Dummy		CW□K-2AE01	CW□K-21BE01	
		2	—	Dummy				
		3	NC	●				
	1NO-1NC (11)	1	NO		●	CW□K-2AE11	CW□K-21BE11	
		2	—	Dummy				
		3	NC	●				
	2NO (20)	1	NO		●	CW□K-2AE20	CW□K-21BE20	
		2	—	Dummy				
		3	NO		●			
	2NC (02)	1	NC	●		CW□K-2AE02	CW□K-21BE02	
		2	—	Dummy				
		3	NC	●				
	2NO-1NC (21)	1	NO		●	CW□K-2AE21	CW□K-21BE21	
		2	NO		●			
		3	NC	●				
	1NO-2NC (12)	1	NO		●	CW□K-2AE12	CW□K-21BE12	
		2	NC	●				
		3	NC	●				
	3NO (30)	1	NO		●	CW□K-2AE30	CW□K-21BE30	
		2	NO		●			
		3	NO		●			
	3NC (03)	1	NC	●		CW□K-2AE03	CW□K-21BE03	
		2	NC	●				
		3	NC	●				
	2NO-2NC (22)	1	NO/NC	NO	●	CW□K-2AE22	CW□K-21BE22	
				NC	●			
		2	—	Dummy				
	4NO (40)	1	2NO	NO		●	CW□K-2AE40	CW□K-21BE40
				NO		●		
				NO		●		
		2	—	Dummy				
		3	2NO	NO		●		
				NO		●		

- Specify a bezel color code in place of □ in the Part No.: 1 (black bezel), 4 (metallic bezel)
- On the spring-returned types, the key can be released only from the maintained position. On the maintained types, the key can be released from every position. Key retained positions are also available. See below.
- Two keys are supplied. • Key cylinder material: Metal
- Besides the standard key (key number 0H), six other keys are also available. See below.
- For the contact block mounting position, see page 12. • For dimensions, see page 19.
- When ordering an optional key or optional key retained positions, specify designation codes as shown below:



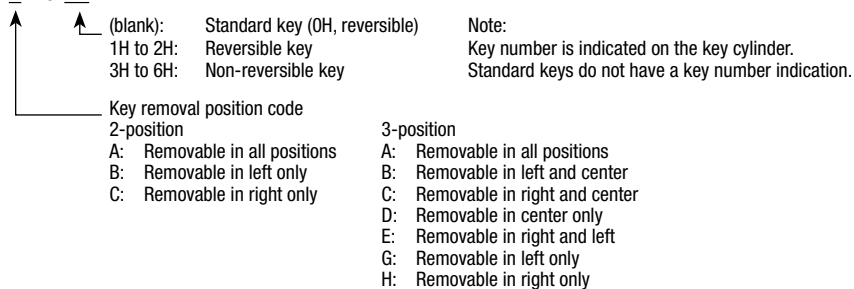

[Example] CW1K-2AE10-1H



Note: Key is retained in the spring-returned position.

# Flush Silhouette Switches CW series Key Selector Switches Ø22

Package quantity: 1

No. of Positions	Contact Configuration	Contact Block		Operator Position			 Maintained	 Spring return from right	 Spring return from left	 Spring return two-way	
		Mounting Position	Contact	L	C	R					
45° 3-position	1NO-1NC (11)	1	NO	●			CW□K-3AE11	CW□K-31BE11	CW□K-32CE11	CW□K-33DE11	
		2	—	Dummy							
		3	NC	●							
	1NO-1NC (11N1)	1	NC		●			CW□K-3AE11N1	CW□K-31BE11N1	CW□K-32CE11N1	CW□K-33DE11N1
		2	—	Dummy							
		3	NO			●					
	1NO-1NC (11N2)	1	NO	●			CW□K-3AE11N2	CW□K-31BE11N2	CW□K-32CE11N2	CW□K-33DE11N2	
		2	NC		●						
		3	—	Dummy							
	1NO-1NC (11N3)	1	—	Dummy			CW□K-3AE11N3	CW□K-31BE11N3	CW□K-32CE11N3	CW□K-33DE11N3	
		2	NC		●						
		3	NO			●					
	1NO-1NC (11N4)	1	—	Dummy			CW□K-3AE11N4	CW□K-31BE11N4	CW□K-32CE11N4	CW□K-33DE11N4	
		2	NO	●		●					
		3	NC	●							
	2NO (20)	1	NO	●			CW□K-3AE20	CW□K-31BE20	CW□K-32CE20	CW□K-33DE20	
		2	—	Dummy							
		3	NO			●					
	2NO (20N1)	1	—	Dummy			CW□K-3AE20N1	CW□K-31BE20N1	CW□K-32CE20N1	CW□K-33DE20N1	
		2	NO	●		●					
		3	NO			●					
	2NC (02)	1	NC		●			CW□K-3AE02	CW□K-31BE02	CW□K-32CE02	CW□K-33DE02
		2	—	Dummy							
		3	NC	●							
	2NC (02N1)	1	—	Dummy			CW□K-3AE02N1	CW□K-31BE02N1	CW□K-32CE02N1	CW□K-33DE02N1	
		2	NC		●						
		3	NC	●							
	2NO-1NC (21)	1	NO	●			CW□K-3AE21	CW□K-31BE21	CW□K-32CE21	CW□K-33DE21	
		2	NO	●		●					
		3	NC	●							
2NO-1NC (21N1)	1	NO	●			CW□K-3AE21N1	CW□K-31BE21N1	CW□K-32CE21N1	CW□K-33DE21N1		
	2	NC		●							
	3	NO			●						
1NO-2NC (12)	1	NO	●			CW□K-3AE12	CW□K-31BE12	CW□K-32CE12	CW□K-33DE12		
	2	NC		●							
	3	NC	●								
1NO-2NC (12N1)	1	NC		●			CW□K-3AE12N1	CW□K-31BE12N1	CW□K-32CE12N1	CW□K-33DE12N1	
	2	NO	●		●						
	3	NC	●								
3NO (30)	1	NO	●			CW□K-3AE30	CW□K-31BE30	CW□K-32CE30	CW□K-33DE30		
	2	NO	●		●						
	3	NO			●						
3NC (03)	1	NC		●			CW□K-3AE03	CW□K-31BE03	CW□K-32CE03	CW□K-33DE03	
	2	NC		●							
	3	NC	●								
2NO-2NC (22)	1	NO/NC	NO NC	●		CW□K-3AE22	CW□K-31BE22	CW□K-32CE22	CW□K-33DE22		
	2	—	Dummy								
	3	NO/NC	NO NC		●						
4NO (40)	1	2NO	NO NO	●		CW□K-3AE40	CW□K-31BE40	CW□K-32CE40	CW□K-33DE40		
	2	—	Dummy								
	3	2NO	NO NO		●						
2NO-2NC (22N2)	1	2NC	NC NC		●		CW□K-3AE22N2	CW□K-31BE22N2	CW□K-32CE22N2	CW□K-33DE22N2	
	2	—	Dummy								
	3	2NO	NO NO		●						

- Specify a bezel color code in place of □ in the Part No.: 1 (black bezel), 4 (metallic bezel)
- On the spring-returned types, the key can be released only from the maintained position. On the maintained types, the key can be released from every position. Key retained positions are also available. See page 14.
- Two keys are supplied. • Key cylinder material: Metal
- Besides the standard key (key number OH), six other keys are also available. See page 14.
- For the contact block mounting position, see right.
- For dimensions, see page 19.

Contact Block Mounting Position







# Flush Silhouette Switches CW series Dimensions Ø22

All dimensions in mm.

## Pushbuttons

See page 5 for mounting hole layout.

### 1 to 3 contacts

#### Round Flush

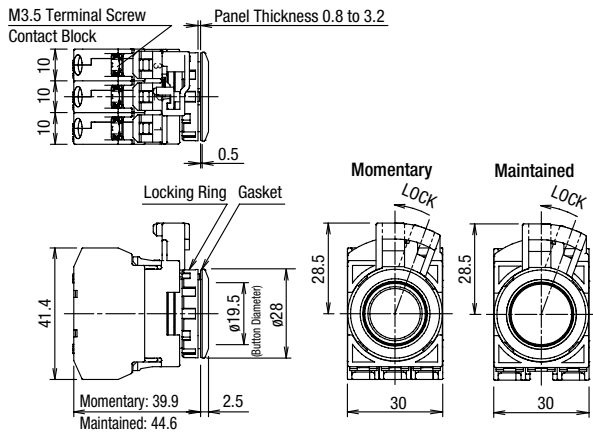

#### Round Extended

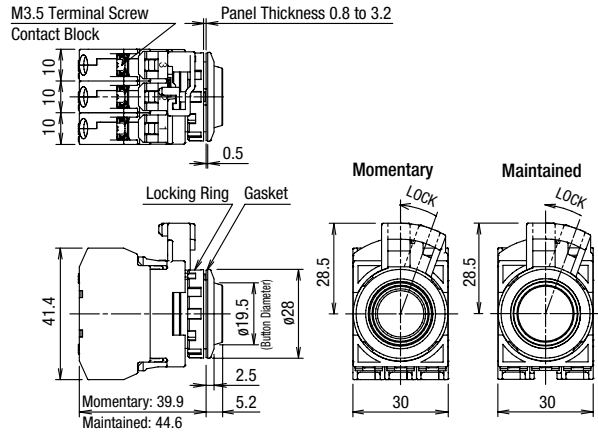

### 4 contacts

#### Round Flush

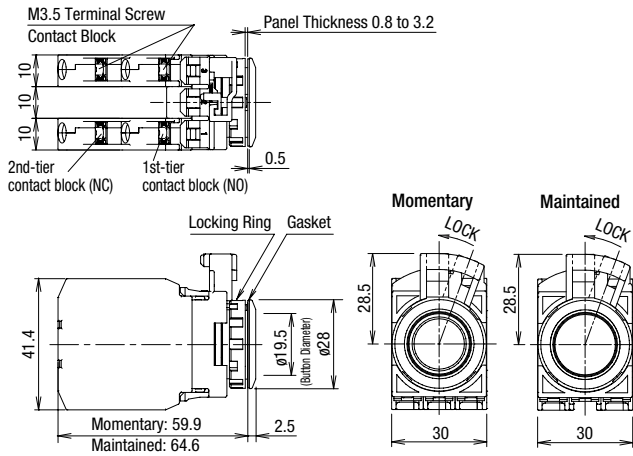

#### Round Extended

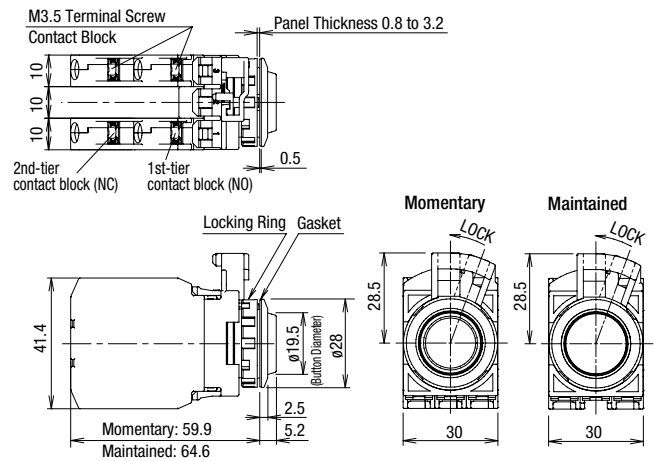

# Ø22 Flush Silhouette Switches CW series Dimensions

## Selector Switches

All dimensions in mm.

### 1 to 3 contacts

See page 5 for mounting hole layout.

#### Knob Operator

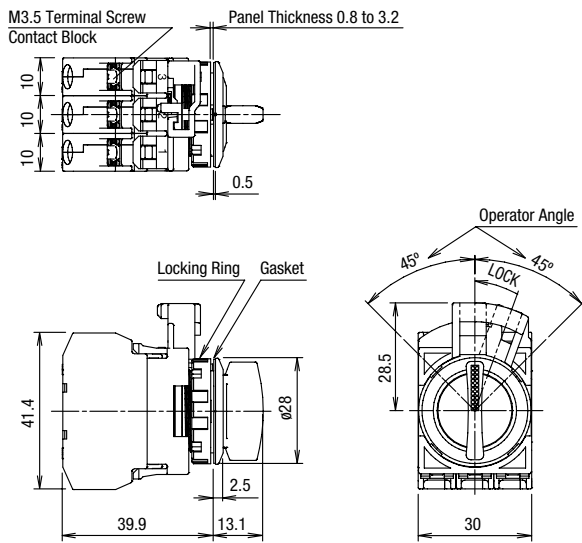

#### Lever Operator

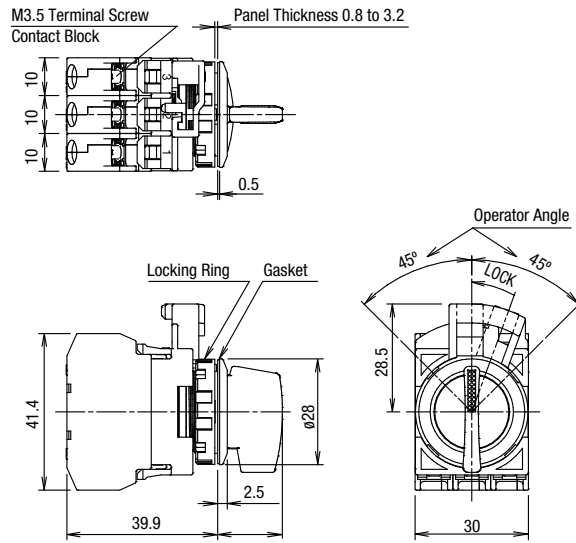

### 4 contacts

#### Knob Operator

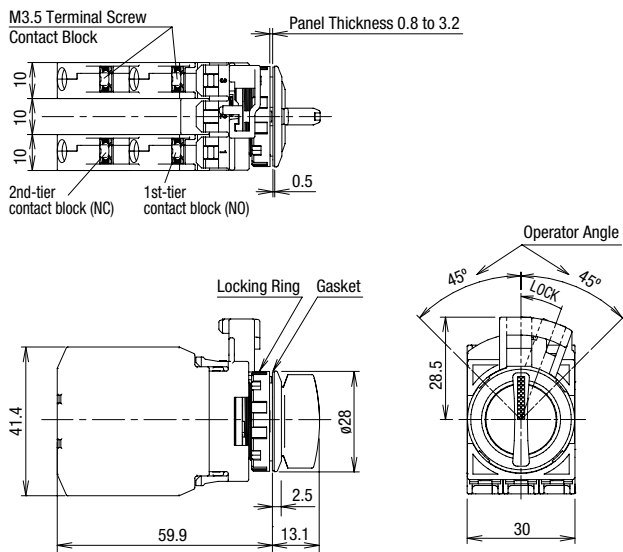

#### Lever Operator

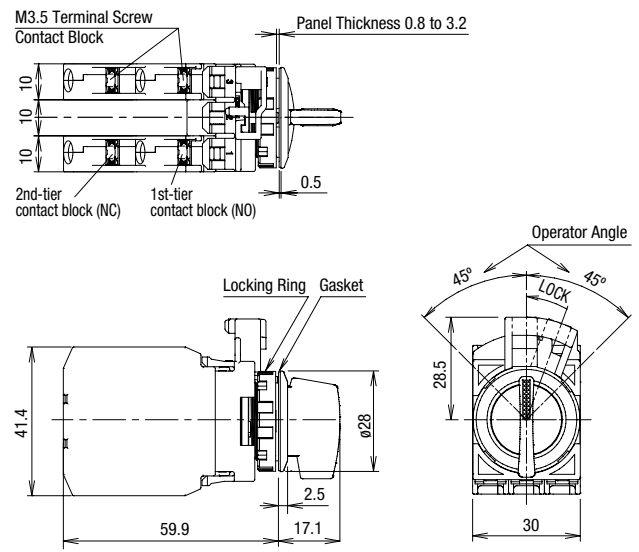

All dimensions in mm.

## Key Selector Switches

### 1 to 3 contacts

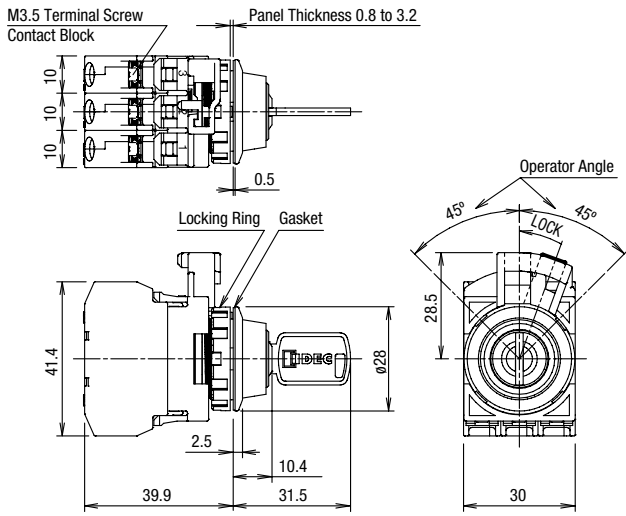

Key No: 0H to 2H (reversible key)

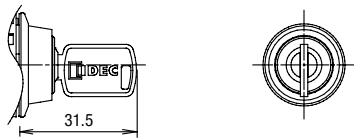

Key No: 3H to 6H (non-reversible key)

## Keys

### Reversible Key

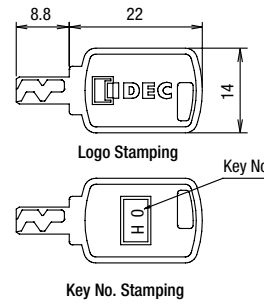

### Non-reversible Key

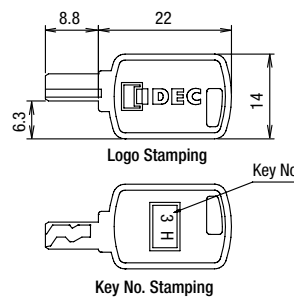

### 4 contacts

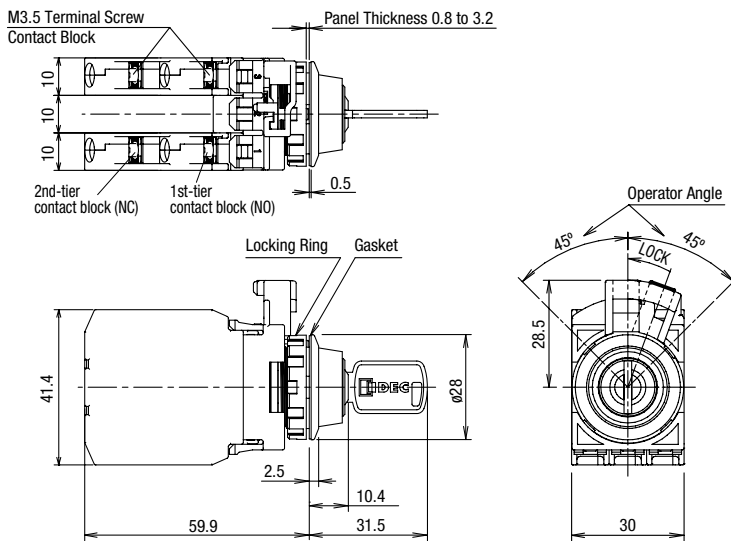

Key No: 0H to 2H (reversible key)

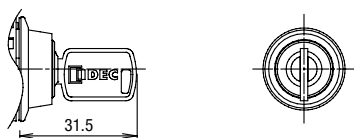





Key No: 3H to 6H (non-reversible key)

See page 5 for mounting hole layout.

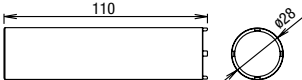
# ø22 Flush Silhouette Switches CW series Accessories / Maintenance Parts

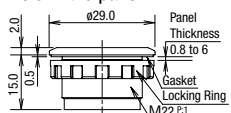
## Accessories

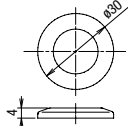
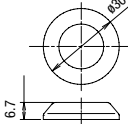
Shape	Material	Part No.	Package Quantity	Remarks
	Brass	MW9Z-T1	1	<ul style="list-style-type: none"> <li>Used to tighten the locking ring when installing the CW series control unit in a panel cut-out.</li> <li>Weight: Approx 150 g</li> </ul> 
	Polyamide (black)	LW9Z-BP1	1	<ul style="list-style-type: none"> <li>Used to plug an unnecessary ø22.3 mm hole in the panel.</li> <li>Degree of protection: IP65</li> <li>Panel thickness: 0.8 to 6.0 mm</li> </ul> 
Rubber Boot 1  2 	1 For round flush 2 For round extended Rubber (Transparent silicon rubber)	CW9Z-D11 CW9Z-D12	1 1	<ul style="list-style-type: none"> <li>Degree of protection: IP66/67 UL Type 4X</li> <li>Panel thickness: 0.8 to 3.2 mm</li> <li>Use with round extended illuminated push-buttons/pushbuttons.</li> </ul>  

## Nameplates

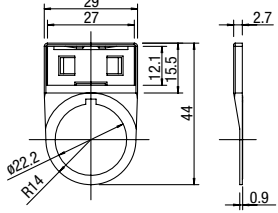
Description	Legend	Material	Part No.	Ordering No.	Package Quantity	Dimensions (mm)
	Order marking plate (HWNP) separately.	Plastic (black)	CWAM	CWAM	1	<ul style="list-style-type: none"> <li>Marking plate HWNP is necessary.</li> <li>Degree of protection: IP65</li> <li>Do not remove the gasket on the operator.</li> </ul>  <ul style="list-style-type: none"> <li>Cannot be used with HW/FB series control box types.</li> </ul>
			CWAM	CWAMPN10	10	

## Making Plate

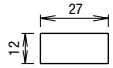
Description	Material	Part No.	Ordering No.	Package Quantity	Dimensions (mm)
	Aluminum (black) 1.0 mm thick	HWNP-*	HWNP-*	1	<ul style="list-style-type: none"> <li>White legend on black background.</li> </ul>  <ul style="list-style-type: none"> <li>Engraving area: W25, H7</li> <li>Thickness: 1.0 mm</li> </ul>
		HWNP-*	HWNP-*PN10	10	

• Specify a legend code in place of \* in the Ordering No.













## Legends

Code	Legend	Code	Legend
0	(blank)	4	STOP
1	ON	31	OFF-ON
2	OFF	33	HAND-AUTO
3	START	53	HAND-OFF-AUTO

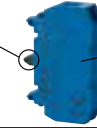

## Maintenance Parts

Used for replacement only. Do not use the maintenance parts to remodel or expand the CW series control units.

Shape	Material	Part No.	Ordering No.	Package Quantity	Remarks	
Button 1  2   3 	1 For round flush	Polyarylate ø19.5 H3.5	<b>CW9Z-B11</b> ①	<b>CW9Z-B11</b> ①PN05	5  • For maintained pushbuttons. • Specify a button color code in place of ① in the Part No. B (black), G (green), R (red), S (blue), W (white), Y (yellow)	
	2 For round extended	Polyarylate ø19.5 H6.2	<b>CW9Z-B12</b> ①	<b>CW9Z-B12</b> ①PN05		5
Lens 2  1  3 	1 Round Flush	Polyarylate	<b>CW9Z-L11</b> ②	<b>CW9Z-L11</b> ②PN05	5  Color code ②: A (amber), C (clear), G (green), R (red), S (blue), Y (yellow) Use a clear (C) lens for pure white (PW) illumination. 1: For illuminated pushbutton, pilot light 2: For illuminated pushbutton 3: For pilot light	
	2 Round Extended	Polyarylate	<b>CW9Z-L12</b> ②	<b>CW9Z-L12</b> ②PN05		5
	3 Round Extended	Polyarylate	<b>CW9Z-L15</b> ②	<b>CW9Z-L15</b> ②PN05		5
Single Contact Block 	1NO		<b>YW-E10R</b>	<b>YW-E10R</b>	1  Push rod color: black Housing color: blue and black Terminal No.: 3-4	
	1NC		<b>YW-E01</b>	<b>YW-E01</b>		1  Push rod color: red Housing color: reddish purple Terminal No.: 1-2
Double Contact Block   (photo: YW-EW1R1)	2NO		<b>YW-EW2R0</b>	<b>YW-EW2R0</b>	1  Push rod color: black Housing color: blue and black Terminal No. 1st tier: 13-14 2nd tier: 23-24	
	2NC		<b>YW-EW02</b>	<b>YW-EW02</b>		1  Push rod color: red Housing color: reddish purple Terminal No. 1st tier: 11-12 2nd tier: 21-22
	1NO, 1NC		<b>YW-EW1R1</b>	<b>YW-EW1R1</b>		1  Push rod color: gray Housing color: reddish purple/blue Terminal No. 1st tier: 13-14 2nd tier: 21-22
Dummy Block 	Polyamide (black)	<b>CW-DB</b>	<b>CW-DBPN05</b>	5		
Locking Ring 	Polyamide (black)	<b>CW9Z-LN</b>	<b>CW9Z-LNPN05</b>	5		
Gasket 	Nitrile rubber	<b>CW9Z-WM</b>	<b>CW9Z-WMPN10</b>	10	Waterproof gasket between CW control unit bezel and the mounting panel.   Thickness: 0.5	
Spare Key  Non-reversible Reversible	Zinc (nickel-plated)	<b>LA9Z-SK-□</b>	<b>LA9Z-SK-□PN02</b>	2	Specify a key No. in place of □. 0H: Standard key (reversible) 1H to 2H: Reversible key 3H to 6H: Non-reversible key For dimensions, see page 19.	

## LED Module

Package quantity: 1

Shape	Operating Voltage Range	Current Draw	Part No.	Illumination Color Code ②
	6V AC/DC ±10%	15 mA	<b>CW-EAQ2</b> ②	Specify an illumination color code in place of ② in the Part No. A: amber G: green PW: pure white R: red S: blue
	12V AC/DC ±10%	15 mA	<b>CW-EAQ3</b> ②	
	24V AC/DC ±10%	16.5 mA	<b>CW-EAQ4</b> ②	
	100/120V AC ±10%	18 mA	<b>CW-EAQH</b> ②	
	200/220V AC ±10%	20 mA	<b>CW-EAQM</b> ②	
	230/240V AC ±10%	18 mA	<b>CW-EAQM4</b> ②	

• Use a pure white (PW) LED module for yellow (Y) illumination.

## Safety Precautions

- Turn off the power to the CW series control units before installation, removal, wiring, and maintenance. Failure to turn power off may cause electrical shocks or fire hazard.
- For wiring, use wires of a proper size to meet the voltage and current requirements. Tighten the M3.5 terminal screws to a tightening torque of 1.0 to 1.3 N·m. Failure to tighten the terminal screws may cause overheating and fire.

## Operating Instructions

### Notes for Operation

- When using the CW series control units in a safety-related circuit of a control system, observe safety rules and regulations of each country concerning particular applications of the actual machines and facilities. Perform risk assessment before operation to ensure safety.

### Operating Conditions

- In corrosive gas or high-temperature, high-humidity atmosphere, contact failure due to corrosion or color change or breakage of the housing may occur.
- Main parts of the CW series control units are made of plastics. Do not scratch the surface with a sharp object or apply excessive shocks or load, otherwise the control units may be damaged. In particular, keep the button, lens, and bezel from such damage, otherwise appearance and function may be impaired.
- Do not apply detergents, cutting oils, or chemicals which may impair the function and appearance of the CW series control units.

### Removing and Installing the Contact Unit

1. To remove the contact block from the operator, push the yellow locking lever and turn it to the left.



2. To install, align the TOP marking on the operator with the TOP marking on the contact block mounting adaptor, and turn the locking lever to the right.

### Panel Mounting

Remove the contact block from the operator. Remove the locking ring from the operator. Insert the operator into the panel cut-out from the front, tighten the locking ring from the back, then install the contact block to the operator.

### Installation in Panel Cut-out

Remove the locking ring from the operator. With the anti-rotation projection on the operator aligned with the recess in the mounting hole, insert the operator into the mounting hole. Tighten the locking ring from the rear of the panel.

### Note for Panel Mounting

When installing the operator in a panel cut-out, use the optional locking ring wrench (MW9Z-T1) to tighten the locking ring to a recommended tightening torque of 1.2 N·m. Do not use pliers and do not tighten excessively, otherwise the operator may be damaged.

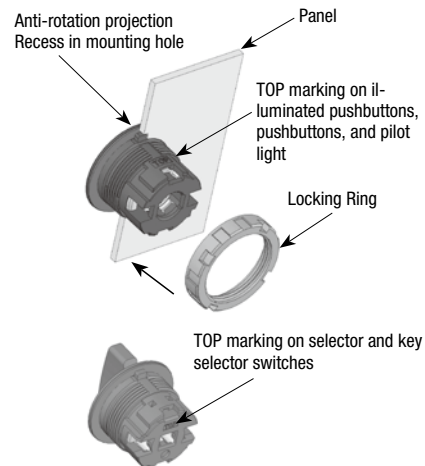

### Mounting Hole

1. Mounting hole dimensions are in compliance with IEC 60947-5-1.
2. If the anti-rotation projection is removed from the bezel, CW series control units can be mounted in ø22.3 mm mounting holes. To remove the anti-rotation projection, remove the gasket and use cutting pliers to break the projection.

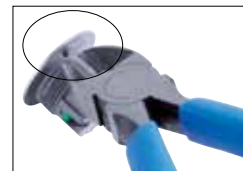

## Operating Instructions

### Pushbuttons (momentary)

Momentary pushbutton caps cannot be removed. Do not tamper with the pushbutton caps using a screwdriver or pliers, otherwise the pushbutton caps may be damaged.

### Pushbuttons (maintained) / Illuminated Pushbuttons / Pilot Lights

#### Removing the button/lens

To remove the button or lens from a pushbutton, illuminated pushbutton or pilot light, insert a flat screwdriver under the flange of the lens at 90° from the TOP marking and twist the screwdriver.

Do not insert the screwdriver too deeply and do not apply excessive force to the lens, otherwise the bezel surface may be damaged.

#### [Screwdriver Insertion Direction]

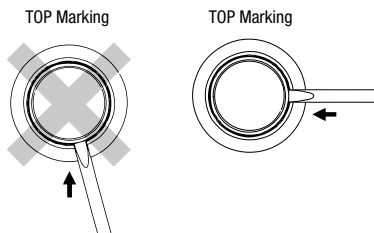

#### [Screwdriver Insertion Angle]

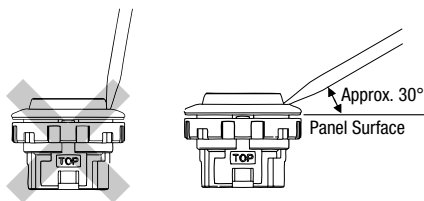

### Installing the Lens

Turn the groove in the lens to the TOP marking on the operator housing. With the groove aligned with the ridge, press the lens in.

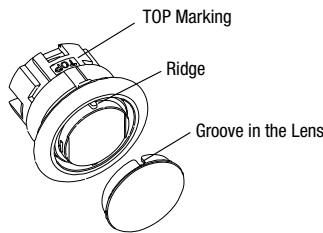

### Marking

Marking plates are not available for CW series illuminated pushbuttons and pilot lights. Marking film can be inserted to indicate legends.

#### Applicable Marking Film Size

Illuminated Pushbutton (Round Flush) Pilot Light (Round Flush, Round Extended)	Illuminated Pushbutton (Round Extended)

Thickness: 0.2 mm maximum

Film material: Polyester (recommended)

Note: Film is not supplied and must be prepared by the user.

### Installing the Rubber Boot

When using in places where the switches are subjected to water splash or an excessive amount of dust, make sure to use the optional rubber boot. Mount the rubber boot so that the protrusion at the bottom surface of the operator fits with the recess on the operator, placing the rubber boot all around the operator sleeve. Make sure that the protrusion on the rubber boot and the recess on the operator is properly fitted, otherwise, the waterproof and dustproof characteristics are not ensured.

#### How to Install the Rubber Boot

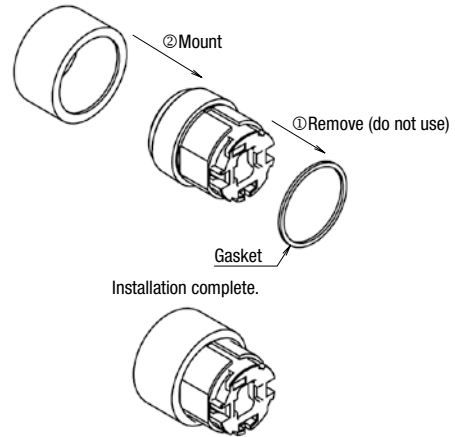

Note: Install the rubber boot before mounting the unit to the panel.

### Maintained

Do not replace the button/lens while the operator is latched. Otherwise the internal structure will be damaged.

### Selector Switches

Turn the selector operator or key to the detent positions.

#### Key Selector Switches

To prevent malfunctions and damage, take the following precautions.

- Insert the key to the bottom before turning.
- Do not remove the key while turning.
- Besides the standard key (0H), six other keys are available. Use a key with a key selector switch of a matching number indicated on the key cylinder. Standard key does not have a key number indication.
- Keys are available in two shapes. Key numbers 0H (standard), 1H, and 2H are reversible keys. Key numbers 3H, 4H, 5H, and 6H are non-reversible keys. Make sure of correct insertion direction.

Contact Blocks and LED Modules

To remove the contact block from the operator, insert a flat screwdriver under the latch and push down the screwdriver as shown below. Before removing the LED module, first remove all contact blocks, and remove the LED module in the same manner.

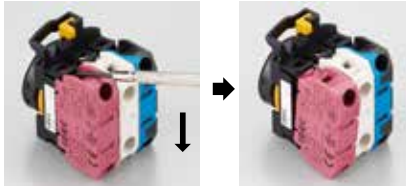

Nameplate / Marking Plate

- Installing the marking plate on a nameplate

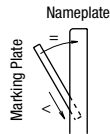

- To remove the marking plate, insert the flat screwdriver between the marking plate and nameplate.

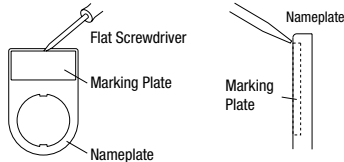

Note: When using a nameplate, the mounting panel thickness is 2.6 mm maximum.

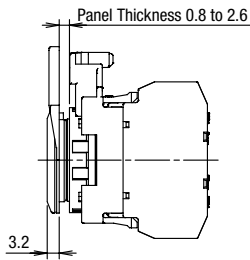

Wiring

Applicable Wires

Stranded wire: 2.0 mm<sup>2</sup> maximum (14AWG)  
 Solid wire: ø1.6 mm maximum (16AWG)

One or two wires can be connected to the terminal.

Applicable Crimping Terminals

[Spade terminal]

When using crimping terminals, be sure to use insulating tubes or use insulated crimping terminals.

Note: Ring terminals cannot be used.

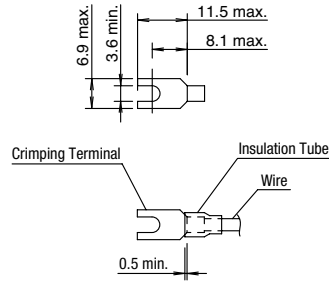

[Ferrule]

When connecting two ferrules to one terminal, use ferrules without insulation.

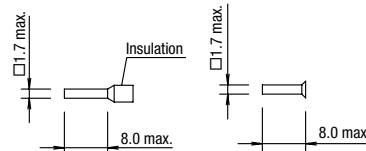

When using spade terminals or ferrules, insert them to the bottom.

[Solid Wire]

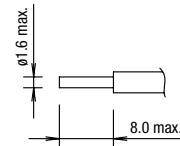

IDEC CORPORATION

www.idec.com

Head Office

6-64, Nishi-Miyahara-2-Chome, Yodogawa-ku, Osaka 532-0004, Japan

<b>USA</b>	IDEC Corporation	Tel: +1-408-747-0550	opencontact@idec.com	<b>Hong Kong</b>	IDEC Izumi (H.K.) Co., Ltd.	Tel: +852-2803-8989	info@hk.idec.com
<b>Germany</b>	APEM GmbH	Tel: +49-40-25 30 54 - 0	service@eu.idec.com	<b>China/Shanghai</b>	IDEC (Shanghai) Corporation	Tel: +86-21-6135-1515	idec@cn.idec.com
<b>Singapore</b>	IDEC Izumi Asia Pte. Ltd.	Tel: +65-6746-1155	info@sg.idec.com	<b>China/Shenzhen</b>	IDEC (Shenzhen) Corporation	Tel: +86-755-8356-2977	idec@cn.idec.com
<b>Thailand</b>	IDEC Asia (Thailand) Co., Ltd	Tel: +66-2-392-9765	sales@th.idec.com	<b>China/Beijing</b>	IDEC (Beijing) Corporation	Tel: +86-10-6581-6131	idec@cn.idec.com
<b>Australia</b>	IDEC Australia Pty. Ltd.	Tel: +61-3-8523-5900	sales@au.idec.com	<b>Japan</b>	IDEC Corporation	Tel: +81-6-6398-2527	marketing@idec.co.jp
<b>Taiwan</b>	IDEC Taiwan Corporation	Tel: +886-2-2698-3929	service@tw.idec.com				

Specifications and other descriptions in this brochure are subject to change without notice. 2018 IDEC Corporation, All Rights Reserved.

