



### DESCRIPTION

The CUP Series has become a standard in the European relay market due to its versatile switch and schematic options. The staggered pin layout gives more space and allows for higher isolation from pin to pin on the PC board when compared to 1.0" x 0.1" relays. Designers have a choice between two switch technologies, the all position mercury wetted MYAD®, and the vertically mounting high performance MH4 contact. There is a choice between plastic and metal covers, as well as non-encapsulated types for lower capacitance. The CUPV models offer high input to output isolation and are BS EN 60950 approved.

### FEATURES

- Standard nominal coil voltages include 5,12 and 24 volts
- Available with plastic and metal can housings
- Designed to meet the most stringent telecommunications specifications on a worldwide basis
- Ideal for optional high isolation between input and output (up to 4000Vrms)
- FCC68 compatible

### RATINGS (@ 25°C)

Parameter	Min	Typ	Max	Units
Switching Voltage				
Switch option 5			1000	Volts
Switch option 6			500	Volts
Switching Current				
Switch option 5 or 6			2	Amps
Carry Current				
Switch option 5 or 6			3	Amps
Switching Frequency				
Switch option 5			200	Hz
Switch option 6			300	Hz
Contact Resistance				
Switch option 5			40	mΩ
Switch option 6			100	mΩ
CUPV Switch option 6			100	mΩ

(See detailed specifications for more information.)

### APPLICATIONS

- Telecom
- Process control
- General purpose electronics
- Industrial

### APPROVALS

- UL Recognized
- EN60950 certified CUPV types

**SPECIFICATIONS**

**CUP C, E, P**

Switch Type 6 All Position WETTED Ccontacts MYAD<sup>®</sup>      Switch Type 5<sup>(2)</sup> WETTED Ccontacts MH4

All parameters are at 25°C unless otherwise stated.

PARAMETER	CONDITIONS	SYMBOL	MIN	TYP	MAX	MIN	TYP	MAX	UNITS
<b>Contact Ratings</b>									
Switching Voltage	Max DC/PeakAC Resistive	VL	-	-	500	-	-	1000	Volts
Switching Current	Max DC/PeakAC Resistive	IL	-	-	2	-	-	2	Amps
Carry Current	Max DC/PeakAC Resistive	IC	-	-	3	-	-	3	Amps
Contact Rating	Max DC/PeakAC Resistive	-	-	-	50	-	-	50	Watts
Life Expectancy	Signal Level 1.0 V 10mA	-	-	300	-	-	2000	-	x10 <sup>6</sup> Ops
	Rated Loads <sup>(1)</sup>	-	-	-	-	-	-	-	x10 <sup>6</sup> Ops
Static Contact Resistance	50mV, 10mA	CR	-	-	100	-	-	40	mΩ
Contact Material		-	-	Hg	-	-	Hg	-	-
Hg Content		-	-	16	-	-	40	-	mgrams
<b>Relay Specifications</b>									
Insulation Resistance	Across Open Contacts	IR	10 <sup>8</sup>	-	-	10 <sup>8</sup>	-	-	Ω
	Contact to Coil	-	10 <sup>10</sup>	-	-	10 <sup>10</sup>	-	-	Ω
Capacitance	Across Open Contacts	-	-	1.5	2	-	1	1.5	pF
	Open Contact to Coil	-	-	3.5	3.8	-	2	2.5	pF
	Closed Contact to Coil	-	-	7.5	8	-	5	8	pF
Dielectric Strength	Across Open Contacts	-	1400	-	-	2000	-	-	VDC/Peak AC
	Contacts to Coil	I/O	2800	-	-	2800	-	-	VDC/Peak AC
Operate Time, no bounce	At Nominal Coil Voltage 10Hz Square Wave	TOP	-	1.6	2.7	-	-	3	ms
Release Time	Zener-Diode Suppression	TREL	-	1.4	1.75	-	1.5	2.5	ms
<b>Environmental Ratings</b>									
Storage Temperature		TA	-40	-	+105	-40	-	+105	°C
Operating Temperature		To	-38	-	+75	-38	-	+75	°C
Soldering Temperature	Applied to pins, 5 sec. max.	-	-	-	+260	-	-	+260	°C
Vibration Resistance (Survival)	10 Hz - 500 Hz	G	-	-	10	-	-	10	Gs
Shock Resistance (Survival)	11±1ms, 1/2 Sine Wave	S	-	-	30	-	-	30	Gs
Weight (1A)		-	-	6.5	-	-	6.6	-	grams
Weight (2A2B/5A)		-	-	13.8	-	-	16.7	-	grams

(1) Consult factory for life requirements.  
 (2) Must be mounted vertically ±30°

**SPECIFICATIONS**
**CUP V**  
 Switch Type 6  
 High Performance  
 MYAD®

All parameters are at 25°C unless otherwise stated.

PARAMETER	CONDITIONS	SYMBOL	MIN	TYP	MAX	UNIT
<b>Contact Ratings</b>						
Switching Voltage	Max DC/PeakAC Resistive	VL	-	-	500	Volts
Switching Current	Max DC/PeakAC Resistive	IL	-	-	2	Amps
Carry Current	Max DC/PeakAC Resistive	Ic	-	-	3	Amps
Contact Rating	Max DC/PeakAC Resistive	-	-	-	50	Watts
Life Expectancy	Signal Level 1.0 V 10mA	-	200	300	-	x10 <sup>6</sup> Ops
	Rated Loads <sup>(1)</sup>	-	-	-	-	x10 <sup>6</sup> Ops
Static Contact Resistance	50mV, 10mA	CR	-	-	100	mΩ
Contact Material		-	-	Hg	-	-
Hg Content		-	-	16	-	mgrams
<b>Relay Specifications</b>						
Insulation Resistance	Across Open Contact	IR	10 <sup>8</sup>	-	-	Ω
	Contact to Coil	-	10 <sup>10</sup>	-	-	Ω
Capacitance	Across Open Contacts	-	-	1.5	2	pF
	Open Contact to Coil	-	-	3.5	3.8	pF
Dielectric Strength		-	-	7.5	8	pF
	Between Contacts	-	1400	-	-	VDC/PeakAC
	Contacts to Coil	I/O	5600	-	-	VDC/PeakAC
Operate Time, no bounce	At Nominal Coil Voltage	TOP	-	1.6	2.7	ms
	10Hz Square Wave					
Release Time	Zener-Diode Suppression	TREL	-	1.4	1.75	ms
<b>Environmental Ratings</b>						
Storage Temperature		TA	-40	-	+105	°C
Operating Temperature		To	-38	-	+75	°C
Soldering Temperature	Applied to pins, 5 sec. max.	-	-	-	+260	°C
Vibration Resistance (Survival)	10Hz - 500Hz	G	-	-	10	Gs
Shock Resistance (Survival)	11±1ms, 1/2 Sine Wave	S	-	-	30	Gs
Weight (1A)		-	-	6.5	-	grams
Weight (2A2B/5A)		-	-	13.8	-	grams

(1) Consult factory for life requirements

**COIL SPECIFICATIONS**

Units	Coil Voltage			Coil Resistance			Operate Voltage			Release Voltage		
	Volts			Ω			Volts			Volts		
Conditions				+/- 10%, 25°C			Must operate by 25°C			Must release by 25°C		
Part #	Min	Typ	Max	Min	Typ	Max	Min	Typ	Max	Min	Typ	Max
CUP E 001A505 <sup>(1)</sup>		5	11	94	105	115			3.5	0.5		
CUP E 001A512		12	26	558	620	682			8.4	1.2		
CUP E 001A524		24	39	1260	1400	1540			16.8	1.9		
CUP E 002A505 <sup>(1,2)</sup>		5	9	63	70	77			3.5	0.5		
CUP E 002A512		12	23	378	420	462			8.4	1.3		
CUP E 002A524		24	35	972	1080	1188			16.8	2.2		
CUP E 001A605		5	12	126	140	154			3.75	0.5		
CUP E 001A612		12	32	900	1000	1100			9	1.4		
CUP E 001A624		24	49	2070	2300	2530			18	2.2		
CUP E 002A605 <sup>(3)</sup>		5	11	99	110	121			3.75	0.6		
CUP E 002A612		12	26	540	600	660			9	1.5		
CUP E 002A624		24	43	1440	1600	1760			18	2.3		
CUP V 60003		5	12	126	140	154			3.75	0.5		
CUP V 60004		12	30	900	1000	1100			9	1.4		
CUP V 60005		24	49	2070	2300	2530			18	2.2		
CUP V 60006		48	97	8073	8970	9867			36	4.4		
CUP V 60201		5	6.5	162	180	198			3.75	0.4		
CUP V 60202		12	15	990	1100	1210			9	1		
CUP V 60203		24	30	3816	4240	4664			18	2		
CUP V 60204		48	60	12600	14000	15400			36	4		
CUP V 60401		5	10	99	110	121			3.75	0.6		
CUP V 60402		12	24	540	600	660			9	1.5		
CUP V 60403		24	48	1440	1600	1760			18	1.3		
CUP V 60404		48	94	5580	6200	6820			36	4.8		

(1) Also available in metal cover  
 (2) Other contact forms available: 1A, 2A, 3A, 5A, 1B  
 (3) Other contact forms available: 1A, 2A, 3A, 4A, 5A, 1B

## PERFORMANCE GRAPHS

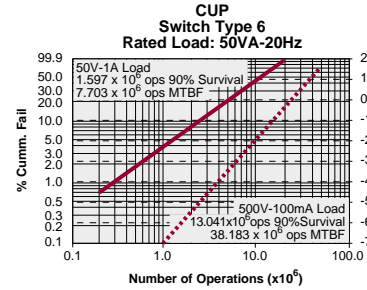
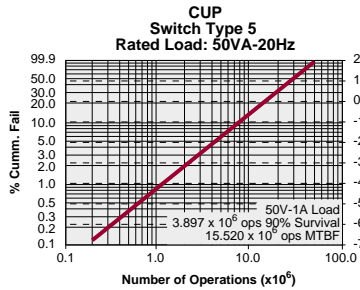

## ORDERING INFORMATION

A complete part number is represented by the digits below.

### CUP C, E, P

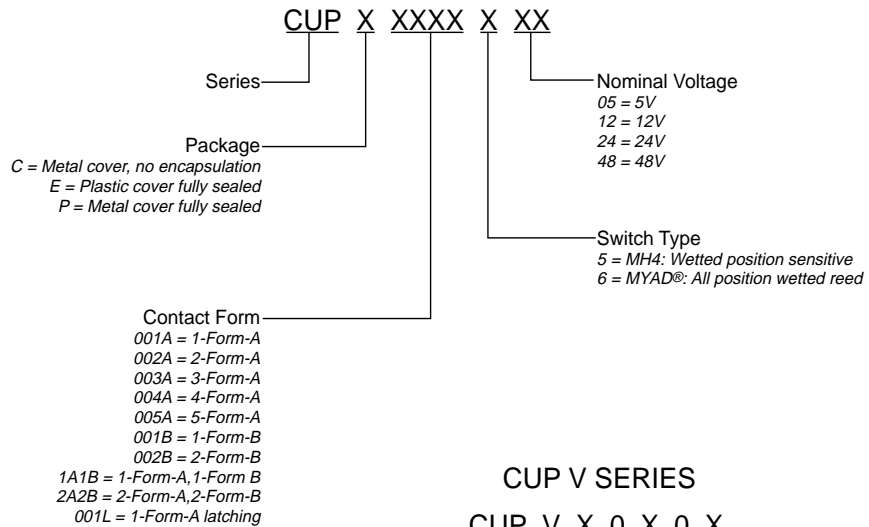

### CUP V SERIES

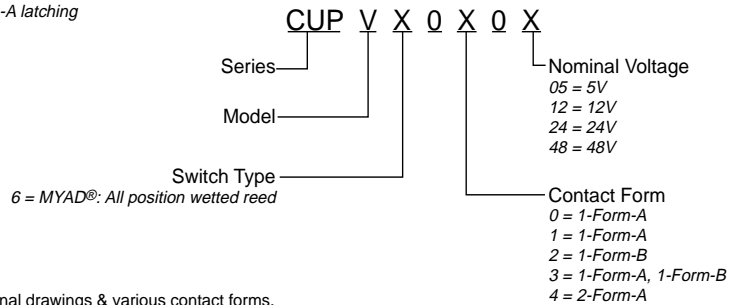

Consult factory for additional drawings & various contact forms.

MECHANICAL DIMENSIONS

DIMENSIONS  
mm  
(inches)

CUP C/CUP P 1A

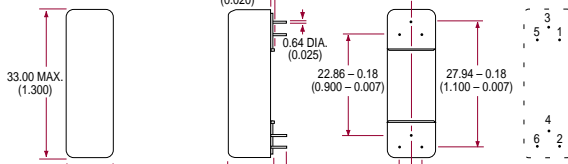

CUP C/CUP P 1A



CUP C/CUP P 2A/1B/1A(Latch)

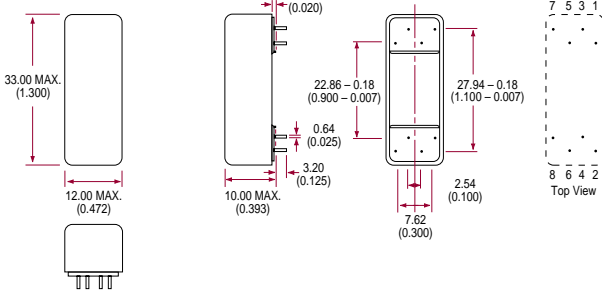

CUP C/CUP P 2A

CUP C/CUP P 1B

CUP C/CUP P 1A(Latch)

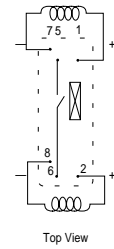
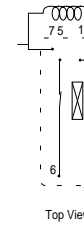
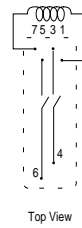

CUP C/CUP P 1A1B/2B/3A

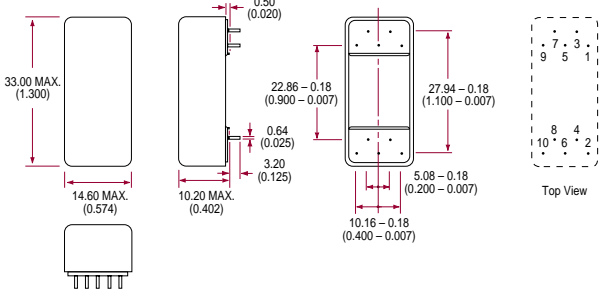

CUP C/CUP P 3A

CUP C/CUP P 2B

CUP C/CUP P 1A1B

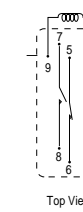
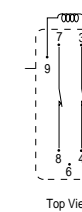
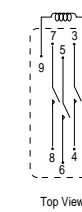

CUP P 5A/2A2B

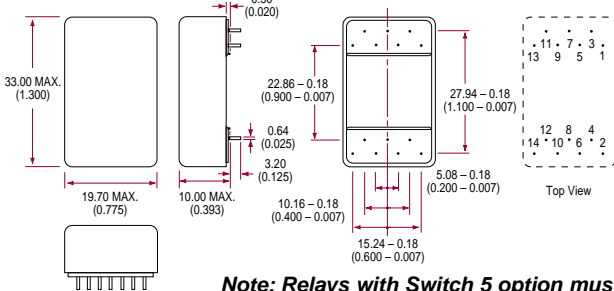

CUP P 5A

CUP P 2A2B

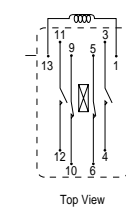

Note: Relays with Switch 5 option must be mounted vertically  $\pm 30^\circ$ .

### MECHANICAL DIMENSIONS

DIMENSIONS  
mm  
(inches)

CUP E/CUP V 1A

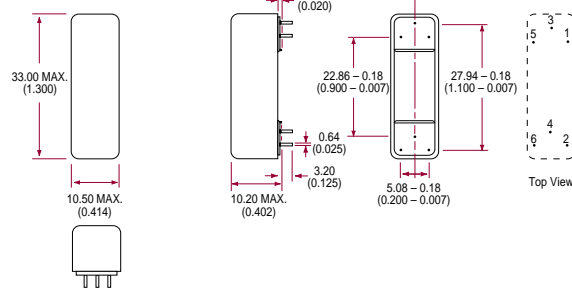

CUP E 1A



CUP V 1A



UP E/CUP V 2A/1B/1A(Latch)

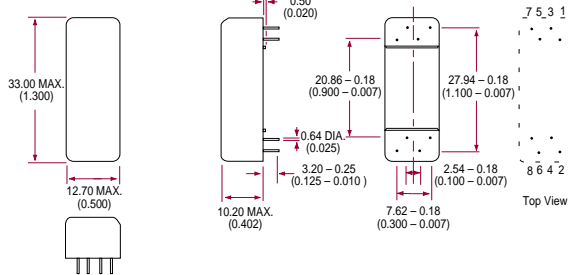

CUP E 2A

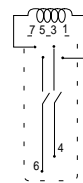

CUP E 1B

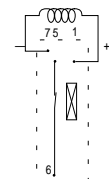

CUP E 1A(Latch)

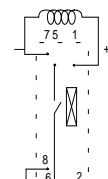

CUP V 2A



CUP V 1B



CUP E/CUP V 2B/3A/1A1B

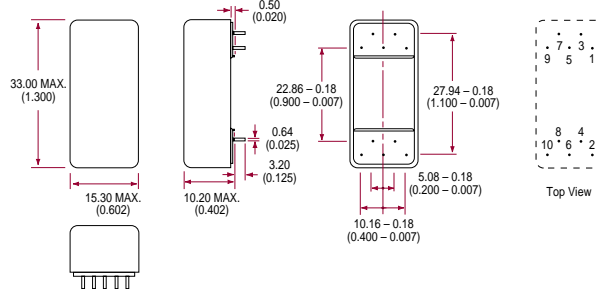

CUP E 3A

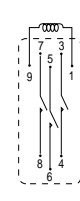

CUP E 2B

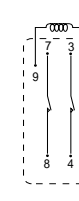

CUP E 1A1B



CUP V 1A1B

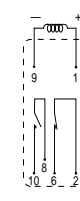

Note: Relays with Switch 5 option must be mounted vertically  $\pm 30^\circ$ .

**MECHANICAL DIMENSIONS**

DIMENSIONS  
mm  
(inches)

**CUP E 4A**

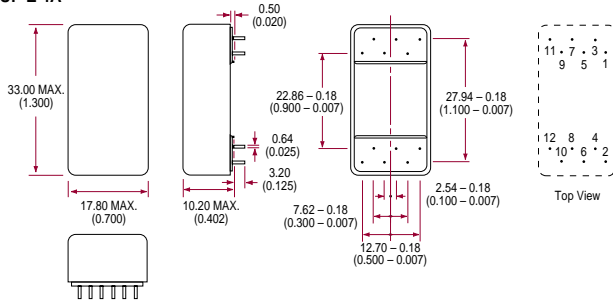

**UP E 4A**



**CUP E/CUP V 5A/2A2B**

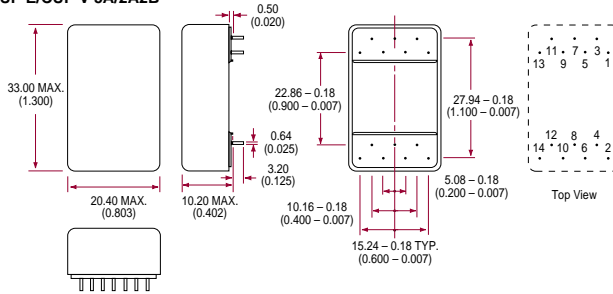

**CUP E 5A**

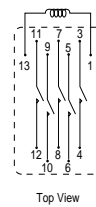

**UP E 2A2B**

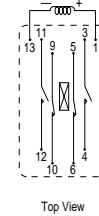

**CUP V 2A2B**

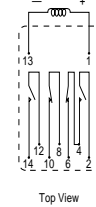

**Note: Relays with Switch 5 option must be mounted vertically  $\pm 30^\circ$ .**