

# General Specifications

## Electrical Capacity (Resistive Load)

**Power Level:** 3A @ 125V AC or 2A @ 250V AC

## Other Ratings

<b>Contact Resistance:</b>	10 milliohms maximum
<b>Insulation Resistance:</b>	1,000 megohms minimum @ 500V DC
<b>Dielectric Strength:</b>	1,000V AC minimum between contacts for 1 minute minimum; 1,500V AC minimum between contacts & case for 1 minute minimum
<b>Mechanical Life:</b>	50,000 operations minimum
<b>Electrical Life:</b>	20,000 operations minimum
<b>Static Capability:</b>	Withstands 12 kilovolts ESD
<b>Contact Timing:</b>	Nonshorting (break-before-make)
<b>Total Travel:</b>	.087" (2.2mm)

## Materials & Finishes

<b>Actuator:</b>	Glass fiber reinforced polyamide
<b>Cover &amp; Case:</b>	Glass fiber reinforced polyamide (UL94V-0)
<b>Movable Contacts:</b>	Copper with silver plating
<b>Stationary Contacts:</b>	Silver capped copper with silver plating
<b>Terminals:</b>	Copper with silver plating

## Environmental Data

<b>Operating Temp Range:</b>	-30°C through +85°C (-22°F through +185°F)
<b>Humidity:</b>	90 ~ 95% humidity for 240 hours @ 40°C (104°F)
<b>Vibration:</b>	10 ~ 55Hz with peak-to-peak amplitude of 1.5mm traversing the frequency range & returning in 1 minute; 3 right angled directions for 2 hours
<b>Shock:</b>	50G (490m/s <sup>2</sup> ) acceleration (tested in 6 right angled directions, with 5 shocks in each direction)

## Installation

<b>Soldering Time &amp; Temp:</b>	Wave Soldering: See Profile A in Supplement section. Manual Soldering: See Profile B in Supplement section.
<b>Cleaning:</b>	These devices are not process sealed. Hand clean locally using alcohol based solution.

## Standards & Certifications

<b>Flammability Standard:</b>	UL94V-0 cover & case
-------------------------------	----------------------

Toggles

Rockers

Pushbuttons

Illuminated PB

Programmable

Keylocks

Rotaries

Slides H

Tactiles

Tilt

Touch

Indicators

Accessories

Supplement

# Distinctive Characteristics

High performance and high quality at a low price.

Molded cover and case of high insulating material withstand 12 kilovolts of electrostatic discharge (ESD), providing antistatic feature.

Cover and case UL 94V-0 flammability rated.

Epoxy sealed terminals to lock out flux, dust, and other contaminants.

Suited for a wide variety of applications including telecommunications, electronic controls, audio devices, and household appliances.

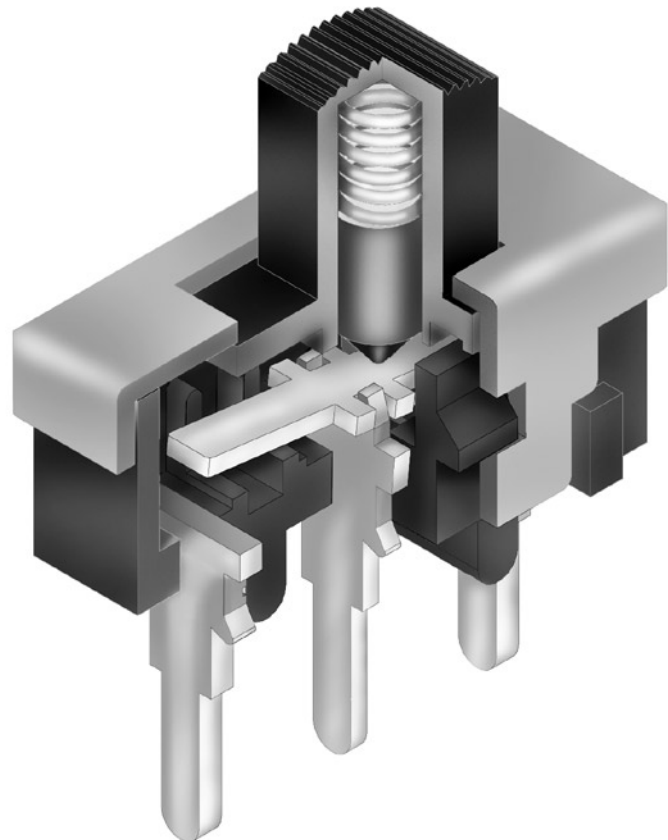

Actual Size

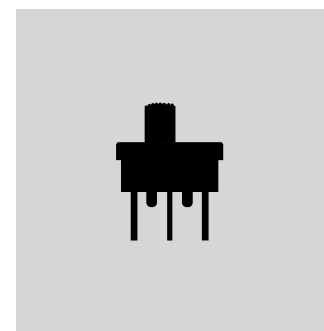

- Toggles
- Rockers
- Pushbuttons
- Illuminated PB
- Programmable
- Keylocks
- Rotaries
- H Slides**
- Tactiles
- Tilt
- Touch
- Indicators
- Accessories
- Supplement

### TYPICAL SWITCH ORDERING EXAMPLE

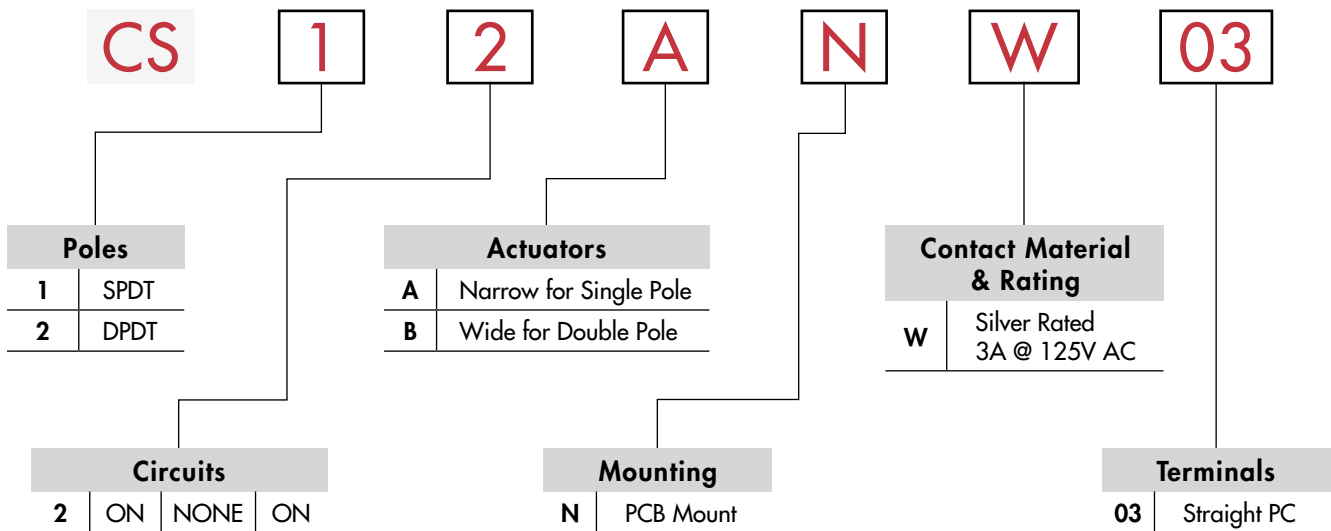

### DESCRIPTION FOR TYPICAL ORDERING EXAMPLE

#### CS12ANW03

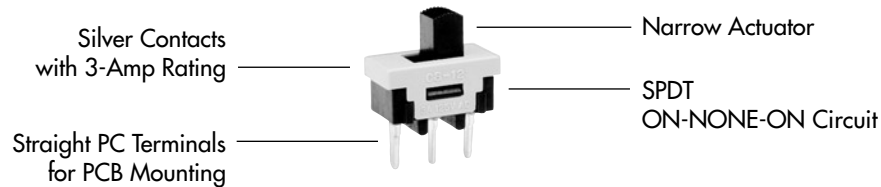

### POLES & CIRCUITS

		Slide Position			Connected Terminals			Throw & Schematics
Pole	Model	Left	Center	Right	Left	Center	Right	
SP	CS12	ON	NONE	ON	2-1	OPEN	2-3	SPDT 
DP	CS22	ON	NONE	ON	2-1 5-4	OPEN	2-3 5-6	DPDT 

Note: Terminal numbers are not actually on switch.

MOUNTING

Panel Cutouts

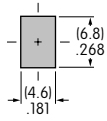

Single Pole

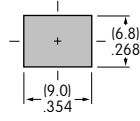

Double Pole

PCB Footprints

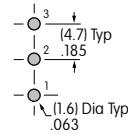

Single Pole

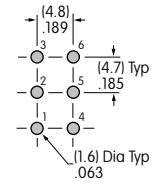

Double Pole

TYPICAL SWITCH DIMENSIONS

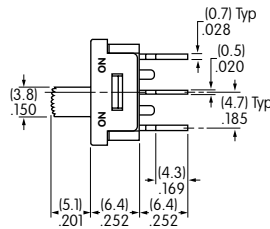
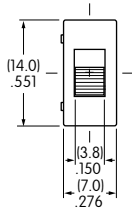

Actuator shown in LEFT position

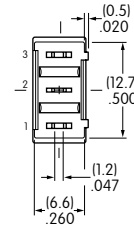

Single Pole



CS12ANW03

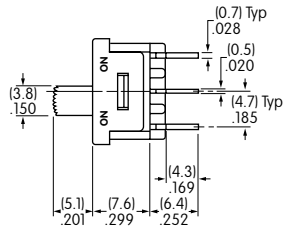
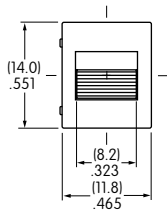

Actuator shown in LEFT position

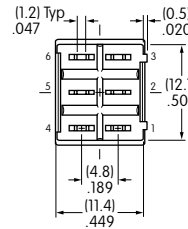

Double Pole



CS22BNW03