

Souriau CLIPPER series



Cost-effective,
reliable, easy to use
industrial connectors

Derived from MIL-C-5015



EATON

Powering Business Worldwide

Souriau CLIPPER series

Typical applications



Off-road vehicles



Railway



Energy and power



Utility



Traffic monitoring



Instrumentation



Communication



Robotic



Building automation & control



Infrastructure



Machinery

Souriau CLIPPER series

CLIPPER is a plastic, cost-effective and easy to use connector derived from MIL-C-5015

CLIPPER provides a durable, cost-effective solution for a variety of industrial applications.

With its high sealing level (IP68), salt spray resistance (1,000 h when mated) and UL qualifications, CLIPPER series connectors are interchangeable with other connectors meeting the standard MIL-C-5015, without compromising the equipment design or the application requirements, even for harsh conditions.

A quick mating system and safety

CLIPPER has a quick, audible and lockable screw coupling system ensuring a safe, confirmed connection. **The scoop proof design protects the contacts from damage**, reducing labor time and installation cost. Additionally, there is **no need for tooling** when inserting or extracting the contacts for easy maintenance.

Mono bloc
thermoplastic
connector

Stamped and
formed contacts
available

No extraction or
insertion tools
needed

PG backshell
adapter enables
use of standard
accessories



Souriau CLIPPER series

1

2

3

4



1 Overview

Technical specifications	05
Range overview	06
Retention plate principle	08
Layouts	08

2 Connectors & backshells

Square flange receptacle and in-line receptacle without contacts	10
Plug without contacts and backnut	11
Electrical thread backshells	12
Accessories	13
IP68 configuration	14
IP67 configuration	16
Mated plug dimensions	19
Mated receptacle dimensions	20
Dimensions receptacle, plug and panel cut out	21

3 Contacts

Description	22
Contact plating selector guide	22
Packaging	23
Machined contacts	24
Stamped and formed contacts	25
Keying capabilities	25

4 Technical information

Tooling	26
Stripping instructions for crimp contacts	27
Handle & interchangeable heads for crimp contacts	28
Assembly instructions	29
Protection provided by an enclosure	34



Technical features

Materials

- Monobloc shell and insulator in thermoplastic material
- Self-extinguishing according to **UL 94 V0**
- Copper alloy contacts, machined or stamped and formed



Electrical

- Withstand voltage: 1500 Vrms min or in accordance with **DIN 57110b**
- Contact resistance < 10 mW
- Current rating per contact:
 - Machined contacts
 - # 20 (7 Amps)
 - # 16 (13 Amps)
 - Stamped and formed contacts
 - # 20 (5 Amps)
 - # 16 (10 Amps)

Environmental

- Working temperature: From - 40°C to +125°C (-40°F to +257°F)
- Salt spray:
 - 48 h min
 - > 1000 h (sealed mated connectors)
- Sealing: Up to IP68
- Fluid resistance:
 - Oil
 - Petrol, fuel
 - Lubricants
 - For other fluids, please consult us
- Halogen free
- REACH and RoHS compliant



Mechanical

- Durability:
 - Connector: 250 cycles mating/unmating
 - Retention plate: 50 cycles mating/unmating
- Retention force:
 - # 20 = 70 N
 - # 16 = 90 N
- Vibration:
 - Frequency range: 10-2000 Hz, 20 g
 - 10 cycles in accordance with **CEI 68-2-6**
- 180° screw coupling with positive audible safety latch
- Scoop proof
- Interchangeable with MIL-C-5015 connectors

Backnuts

Sealed grommet backnut



Unsealed backnut



Backshells

Unsealed straight backshell for flexible conduit



Unsealed straight cable clamp



Sealed elbow backshell with sealing gland



Sealed straight backshell for flexible conduit

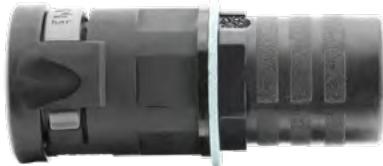

Sealed anti-decoupling sealing gland



Plugs

Unsealed
(without O-ring and mating seal)



Sealed
(with O-ring and mating seal)



Receptacles

Unsealed
(without O-ring)



Sealed
(with O-ring for use with backshell)



Sealed
(with O-ring and panel gasket)



Inline unsealed for male contacts



Inline sealed for male contacts



Backnuts

Unsealed backnut



Sealed grommet backnut



Backshells

Unsealed straight cable clamp



Unsealed straight backshell for flexible conduit



Sealed straight backshell for flexible conduit



Sealed elbow backshell with sealing gland



Sealed anti-decoupling sealing gland



1

Retention plate principle

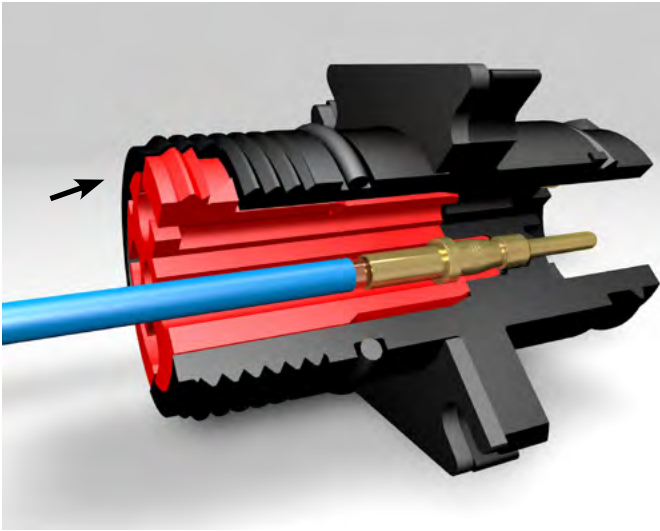

Locked plate

Locked, the retention plate holds the contacts firmly in position.

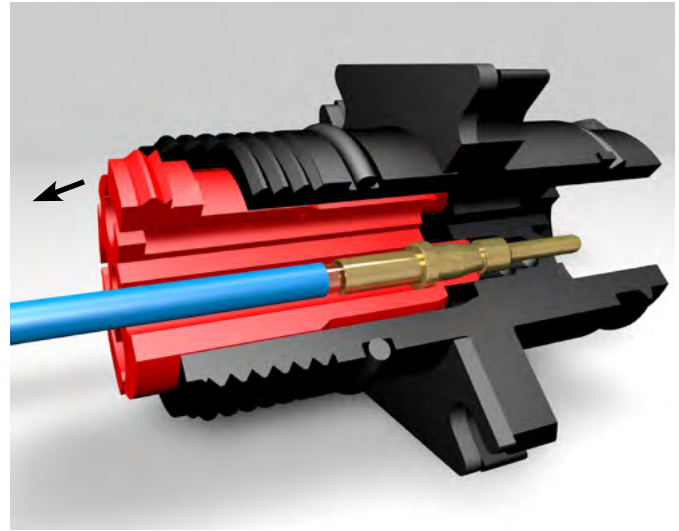

Unlocked plate

Unlocked, the retention plate allows the insertion or extraction of contacts without tooling.

Layouts face male contact

Contacts	Shell size 1	Shell size 2	Shell size 3	Shell size 4
Contact #16 (Ø 0.062" - 1.6mm)	<p>4 contacts, #16</p>	<p>9 contacts, #16</p>	<p>18 contacts, #16</p>	<p>26 contacts, #16</p>
Contact #20 (Ø 0.039" - 1.0mm)	<p>9 contacts, #20</p>	<p>14 contacts, #20</p>	<p>31 contacts, #20</p>	<p>40 contacts, #20</p>

Square flange receptacle and in-line receptacle - Version unsealed without O-ring and sealed with O-ring

2



Unsealed receptacle

Sealed receptacle for use with backshell

Sealed receptacle with panel gasket

In-line receptacle

Shell size	Layout face male contact	Unsealed receptacle		Sealed receptacle for use with backshell		Sealed receptacle with panel gasket		In-line receptacle	
		Male contacts	Female contacts	Male contacts	Female contacts	Male contacts	Female contacts	Unsealed for male contacts	Sealed for male contacts
1		CL1M1100	CL1R1100	CL1M1101	CL1R1101	CL1M1102	CL1R1102	CL1C1100	CL1C1101
	4 contacts, #16								
		CL1M1200	–	CL1M1201	–	CL1M1202	–	CL1C1200	CL1C1201
2	9 contacts, #20								
		CL1M2100	CL1R2100	CL1M2101	CL1R2101	CL1M2102	CL1R2102	CL1C2100	CL1C2101
	9 contacts, #16								
3		CL1M2200	–	CL1M2201	–	CL1M2202	–	CL1C2200	CL1C2201
	14 contacts, #20								
		CL1M3100	CL1R3100	CL1M3101	CL1R3101	CL1M3102	CL1R3102	CL1C3100	CL1C3101
4	18 contacts, #16								
		CL1M3200	–	CL1M3201	–	CL1M3202	–	CL1C3200	CL1C3201
	31 contacts, #20								
4		CL1M4100	–	CL1M4101	–	CL1M4102	–	CL1C4100	CL1C4101
	26 contacts, #16								
		CL1M4200	CL1R4200	CL1M4201	CL1R4201	CL1M4202	CL1R4202	CL1C4200	CL1C4201
40 contacts, #20									

Plug and backnut - Version unsealed without O-ring and sealed with O-ring



2

Shell size	Layout face male contact	Unsealed plug mating seal		Sealed plug mating seal		Sealed backnut		Unsealed backnut
		Male contacts	Female contacts	Male contacts	Female contacts	Male contacts	Female contacts	Male and female contacts
1		CL1P1100	CL1F1100	CL1P1101	CL1F1101 (IP67) CL1F1103 (IP68)	CL111102	CL111101	CL111000
		-	CL1F1200	-	CL1F1201 (IP67) CL1F1203 (IP68)	CL111202	CL111201	
2		CL1P2100	CL1F2100	CL1P2101	CL1F2101 (IP67) CL1F2103 (IP68)	CL11202	CL11201	CL112000
		-	CL1F2200	-	CL1F2201 (IP67) CL1F2203 (IP68)	-	-	
3		CL1P3100	CL1F3100	CL1P3101	CL1F3101 (IP67) CL1F3103 (IP68)	CL113102	CL113101	CL113000
		-	CL1F3200	-	CL1F3201 (IP67) CL1F3203 (IP68)	CL113202	CL113201	
4		-	CL1F4100	-	CL1F4101 (IP67) CL1F4103 (IP68)	CL114102	CL114101	CL114000
		CL1P4200	CL1F4200	CL1P4201	CL1F4201 (IP67) CL1F4203 (IP68)	CL114202	CL114201	

2

Connectors & backshells

Electrical thread backshells (PG)

Straight backshell for flexible conduit - Unsealed (IP40)

2



Shell size	Part number
1 (PG 13.5)	CL101040
2 (PG 16)	CL102040
3 (PG 21)	CL 103040
4 (PG 29)	CL124040
4 (PG 36)	CL104040

Straight cable clamp - Unsealed (IP40)



Shell size	Part number
1 (PG 13.5)	CL101030
2 (PG 16)	CL102030
3 (PG 21)	CL103030
4 (PG 29)	CL124030

Elbow backshell with sealing gland - Sealed*



Shell size	Part number
1 (PG 13.5)	CL101051
2 (PG 16)	CL102051
3 (PG 21)	CL103051
4 (PG 29)	CL124051

Straight backshell for flexible conduit systems - Sealed*

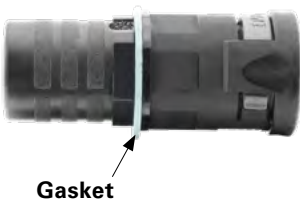

Shell size	Part number
1 (PG 13.5)	CL101041
2 (PG 16)	CL102041
3 (PG 21)	CL103041
4 (PG 29)	CL124041
4 (PG 29)	CL104041

Anti-decoupling sealing gland backshell - Sealed*



Shell size	Part number
1 (PG 13.5)	CL101021
2 (PG 16)	CL102021
3 (PG 21)	CL103021
4 (PG 29)	CL124021
4 (PG 36)	CL104021

* Electrical thread backshells are always supplied complete with the adaptor.

Panel gasket (for square flange receptacle)



Shell size	Part number
1	CL191001
2	CL192001
3	CL193001
4	CL194001

2

Straight adaptors



Shell size	Part number
1	CL101000
2	CL102000
3	CL103000
4	CL104000

90° sealed adaptors for receptacles*



Shell size	Part number
1	CL131001
2	CL132001
3	CL133001
4	CL134001

* with panel gasket.

IP67 Dust cap for receptacle



Shell size	Part number
1	CL141001
2	CL142001
3	CL143001
4	CL144001

* Electrical thread backshells are always supplied complete with the adaptor.

2

Connectors & backshells

IP68 configuration

Sealed version resisting water immersion up to 100 ft / 30 m

2

Wall mount receptacle

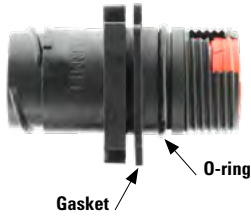

Inline receptacle



Plug



Sealed anti decoupling
sealing gland

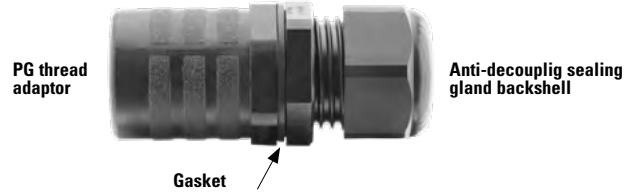

Sealed version resisting water immersion up to 100 ft / 30 m - Sealed version with O-ring

2



Sealed receptacle and panel gasket

Sealed inline receptacle

Sealed plug and mating seal

Sealed anti decoupling sealing gland

Shell size	Layout face male contact	Male contacts	Male contacts	Female contacts	Female contacts
1		CL1M1102	CL1C1101	CL1F1103	CL101021 (PG 13.5)
	4 contacts, #16				
		CL1M1202	CL1C1202	CL1F1203	—
	9 contacts, #20				
2		CL1M2102	CL1C2101	CL1F2103	CL102021 (PG 16)
	9 contacts, #16				
		CL1M2202	CL1C2201	CL1F2203	—
	14 contacts, #20				
3		CL1M3102	CL1C3101	CL1F3103	CL103021 (PG 21)
	18 contacts, #16				
		CL1M3202	CL1C3201	CL1F3203	—
	31 contacts, #20				
4		CL1M4102	CL1C4101	CL1F4103	CL124021 (PG 29)
	26 contacts, #16				
		CL1M4202	CL1C4201	CL1F4203	CL104021 (PG 36)
	40 contacts, #20				

2

Connectors & backshells

IP67 configuration

Temporary water tightness

2

Wall mount receptacle

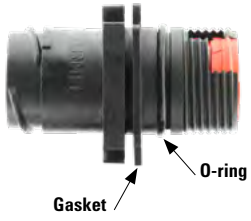

Inline receptacle



Plug

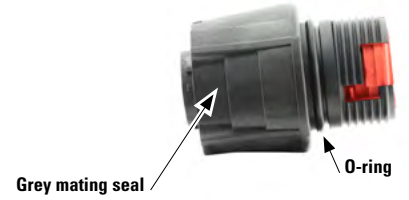

Sealed backnut

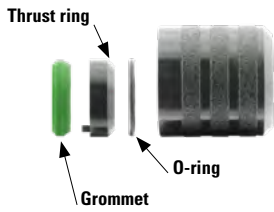

Elbow backshell with sealing gland



Straight backshell for flexible conduit

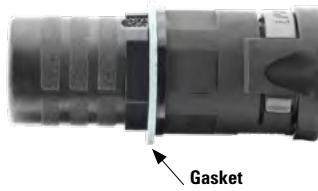

Anti-decoupling sealing gland backshell



Temporary water tightness - Sealed version with O-ring

2



Sealed receptacle and panel gasket



Sealed plug and mating seal











Sealed inline receptacle

Shell size	Layout face male contact	Male contacts	Female contacts	Male contacts	Female contacts	Male contacts
1		CL1M1102	CL1R1102	CL1P1101	CL1F1101	CL1C1101
	4 contacts, #16	CL1M1202	–	CL1F1201	–	CL1C1201
2		CL1M2102	CL1R2102	CL1P2101	CL1F2101	CL1C2101
	9 contacts, #20	CL1M2202	–	–	CL1F2201	CL1C2201
		CL1M3102	CL1R3102	CL1P3101	CL1F3101	CL1C3101
	9 contacts, #16	CL1M3202	–	–	CL1F3201	CL1C3201
3		CL1M3102	CL1R3102	CL1P3101	CL1F3101	CL1C3101
	18 contacts, #16	CL1M3202	–	–	CL1F3201	CL1C3201
3		CL1M3102	CL1R3102	CL1P3101	CL1F3101	CL1C3101
	31 contacts, #20	CL1M3202	–	–	CL1F3201	CL1C3201
4		CL1M4102	–	–	CL1F4101	CL1F4101
	26 contacts, #16	CL1M4202	CL1R4202	CL1P4201	CL1F4201	CL1C4201
		CL1M4202	CL1R4202	CL1P4201	CL1F4201	CL1C4201
40 contacts, #20						

Temporary water tightness - Sealed version with O-ring

2



Shell size	Layout face male contact	Sealed plug and mating seal		Elbow backshell with sealing gland	Straight backshell for flexible conduit	Anti-decoupling sealing gland backshell
		Male contacts	Female contacts	Male contacts		
1	 4 contacts, #16	CL111102	CL111101	CL101051 (PG 13.5)	CL101041 (PG 13.5)	CL101021 (PG 13.5)
	 9 contacts, #20	CL111202	CL111201	—	—	—
2	 9 contacts, #16	CL112102	CL112101	CL102051 (PG 16)	CL102041 (PG 16)	CL102021 (PG 16)
	 14 contacts, #20	—	—	—	—	—
3	 18 contacts, #16	CL113102	CL113101	CL103051 (PG 21)	CL103041 (PG 21)	CL103021 (PG 21)
	 31 contacts, #20	CL113202	CL113201	—	—	—
4	 26 contacts, #16	CL114102	CL114101	CL124051 (PG 29)	CL124041 (PG 29)	CL104041 (PG 36) CL124021 (PG 29)
	 40 contacts, #20	CL114202	CL114201	—	—	—

Plug with adaptor

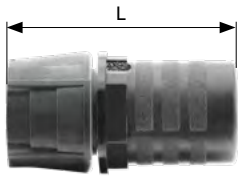

Shell size	L inches	mm
1	2.01	51.0
2	2.09	53.2
3	2.09	53.2
4 (PG 29)	2.17	55.2
4 (PG 36)	2.17	55.2

Plug with backnut

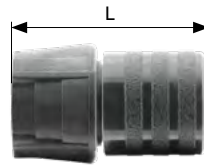

Shell size	L inches	mm
1	1.81	46.0
2	1.85	47.0
3	1.85	47.0
4 (PG 29)	—	—
4 (PG 36)	1.85	47.0.2

Plug with straight cable clamp



Shell size	L inches	mm	C (cable acceptance)	
			inches	mm
1	2.68	68.0	0.24/0.55	6.0/14.0
2	2.85	72.5	0.24/0.63	6.0/16.0
3	3.03	77.0	0.31/0.83	8.0/21.0
4 (PG 29)	3.41	86.5	0.39/1.10	10.0/28.0
4 (PG 36)	—	—	—	—

Plug with straight backshell for flexible conduit

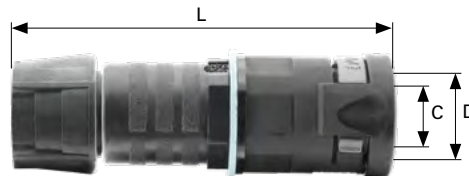

Shell size	L inches	mm	C (cable acceptance)		D (conduit Pmaxflex)	
			inches	mm	inches	mm
1	3.41	86.5	0.63	16.0	0.67	17.0
2	3.50	89.0	0.63	16.0	0.67	17.0
3	3.62	92.0	0.85	21.5	0.91	23.1
4 (PG 29)	3.70	94.0	1.08	27.4	1.14	28.9
4 (PG 36)	4.25	108.0	1.42	36.0	1.42	36.0

Plug with anti-decoupling sealing gland

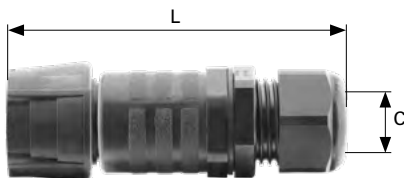

Shell size	L inches	mm	C (cable acceptance)	
			inches	mm
1	3.15	80.0	0.24/0.47	6.0/12.0
2	3.27	83.0	0.39/0.55	10.0/14.0
3	3.35	85.0	0.51/0.71	13.0/18.0
4 (PG 29)	3.74	95.0	0.71/0.98	18.0/25.0
4 (PG 36)	4.02	102.0	0.87/1.26	22.0/32.0

Plug with elbow backshell with sealing gland

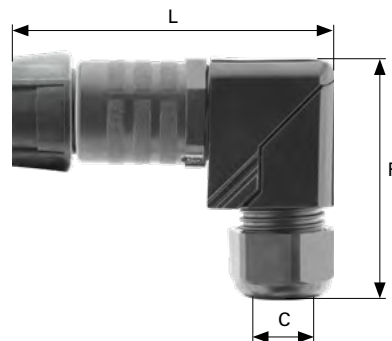

Shell size	L inches	mm	R max		C (cable acceptance)	
			inches	mm	inches	mm
1	3.31	84.0	2.24	57.0	0.24/0.47	6.0/12.0
2	3.46	88.0	2.34	59.5	0.39/0.55	10.0/14.0
3	3.77	96.0	2.87	73.0	0.51/0.71	13.0/18.0
4 (PG 29)	4.29	109.0	3.58	91.0	0.71/0.98	18.0/25.0
4 (PG 36)	—	—	—	—	—	—

Receptacle with adaptor

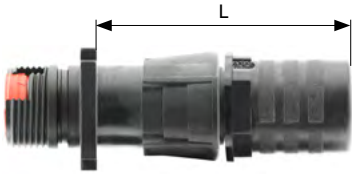

Shell size	L inches	mm
1	2.29	58.2
2	2.33	59.2
3	2.33	59.2
4 (PG 29)	2.41	61.2
4 (PG 36)	2.41	61.2

Receptacle with backnut

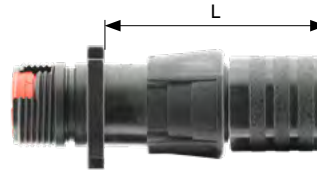

Shell size	L inches	mm
1	2.09	53.0
2	2.09	53.0
3	2.09	53.0
4 (PG 29)	–	–
4 (PG 36)	2.09	53.0

Receptacle with straight cable clamp

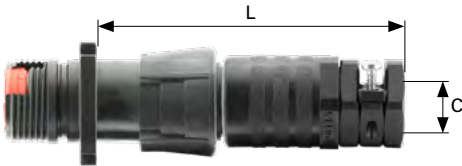

Shell size	L inches	mm	C (cable acceptance)	
			inches	mm
1	2.97	75.5	0.24/0.55	6.0/13.9
2	3.09	78.5	0.24/0.63	6.0/16.0
3	3.27	83.0	0.31/0.83	7.8/21.0
4 (PG 29)	3.60	91.5	0.39/1.10	9.9/27.9
4 (PG 36)	–	–	–	–

Receptacle with straight backshell for flexible conduit

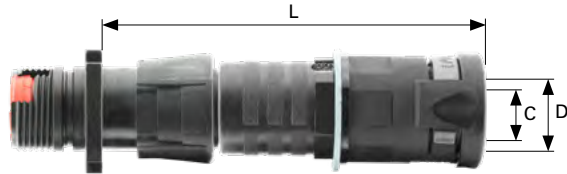

Shell size	L inches	R max		C (cable acceptance)		
		inches	mm	inches	mm	
1	3.70	94.0	0.63	16.0	0.67	17.0
2	3.74	95.0	0.63	16.0	0.67	17.0
3	3.86	98.0	0.85	21.5	0.91	23.1
4 (PG 29)	3.94	100.0	1.08	27.4	1.14	28.9
4 (PG 36)	4.47	113.5	1.42	36.0	1.42	36.0

Receptacle with anti-decoupling sealing gland

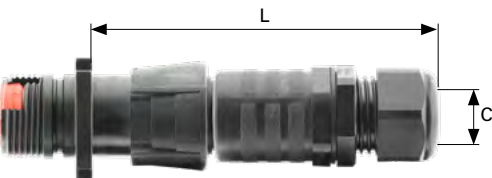

Shell size	L inches	mm	C (cable acceptance)	
			inches	mm
1	3.43	87.0	0.24/0.47	6.0/11.9
2	3.50	89.0	0.39/0.55	9.9/13.9
3	3.58	91.0	0.51/0.71	12.9/18.0
4 (PG 29)	3.98	101.0	0.71/0.98	18.0/24.8
4 (PG 36)	4.25	108.0	0.87/1.26	22.0/32.0

Receptacle with elbow backshell with sealing gland

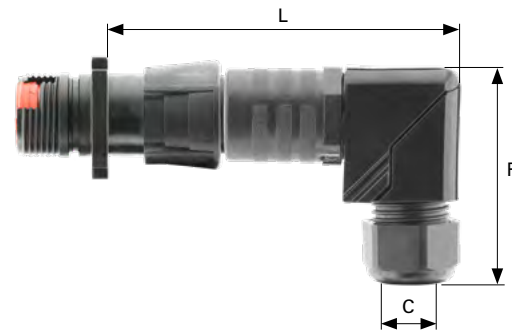

Shell size	L inches	mm	R max		C (cable acceptance)	
			inches	mm	inches	mm
1	3.58	91.0	2.24	56.8	0.24/0.47	6.0/11.9
2	3.70	94.0	2.34	59.4	0.39/0.55	9.9/13.9
3	4.01	102.0	2.87	72.8	0.51/0.71	12.9/18.0
4 (PG 29)	4.52	115.0	3.58	90.9	0.71/0.98	18.0/24.8
4 (PG 36)	-	-	-	-	-	-

Receptacle

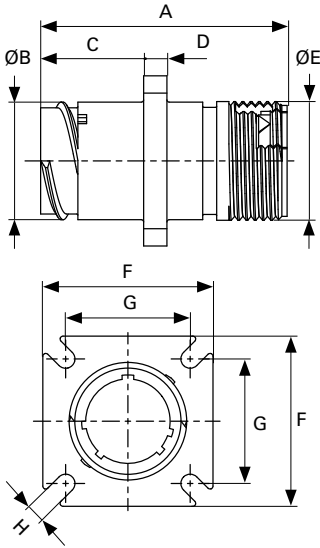

Shell size	A max inches	A max mm	ØB inches	ØB mm	C inches	C mm	D inches	D mm	ØE	F inches	F mm	G inches	G mm	H inches	H mm
1	1.67	42.35	0.83	20.20	0.71	17.7	0.16	4.0	PG 13	1.17	29.24	0.84	21.4	0.13	3.2
2	1.67	42.35	0.96	23.56	0.71	17.7	0.16	4.0	M24x1.5	1.23	30.84	0.96	24.6	0.13	3.2
3	1.67	42.35	1.14	28.24	0.71	17.7	0.16	4.0	PG 21	1.42	35.59	1.11	28.6	0.15	3.8
4	1.67	42.35	1.59	39.66	0.71	17.7	0.16	4.0	M40x1.5	1.89	47.48	1.43	36.5	0.15	3.8

2

Plug

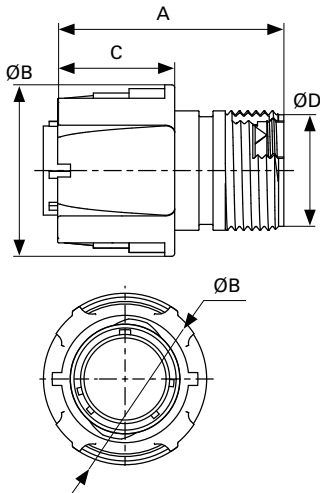

Shell size	A inches	A mm	ØB inches	ØB mm	C inches	C mm	ØD
1	1.52	38.45	1.154	29.30	0.80	20.0	PG 13
2	1.56	39.45	1.28	32.80	0.80	20.0	M24x1.5
3	1.56	39.45	1.46	37.00	0.80	20.0	PG 21
4	1.56	39.45	1.92	49.15	0.80	20.0	M40x1.5

Panel cut out

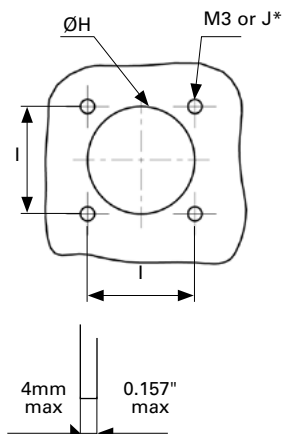

Shell size	ØH inches	ØH mm	I inches	I mm	J inches	J mm
1	0.85	21.60	0.84	21.33	0.13	3.30
2	0.98	24.90	0.97	24.63	0.13	3.30
3	1.22	30.98	1.13	28.70	0.15	3.81
4	1.61	40.90	1.44	36.57	0.15	3.81

Note: *M3 is recommended for all shells but it is possible to use dimension J

3

Contacts

Description

The **CLIPPER series** is delivered without contacts (crimp version) and offers the unique possibility to use the same contact in any layout, as long as it receives the same active part size. This provides opportunity for standardization and subsequent inventory cost reductions, eliminates the need for added tooling and simplifies the assembly process. Souriau contacts are designed for simple snap-in installation, further eliminating the need for insertion tooling.

3 Machined contacts are generally chosen as a better solution for power applications or when lower quantities are needed.

Stamped & Formed contacts offer the ability to be crimped automatically which makes them more suitable for high volume production applications.

Use the graph below for recommendations based on application, mating cycles and current/voltage needs.

Note: Do not mix different plating (i.e. tin plated pin contacts with gold plated socket contacts).

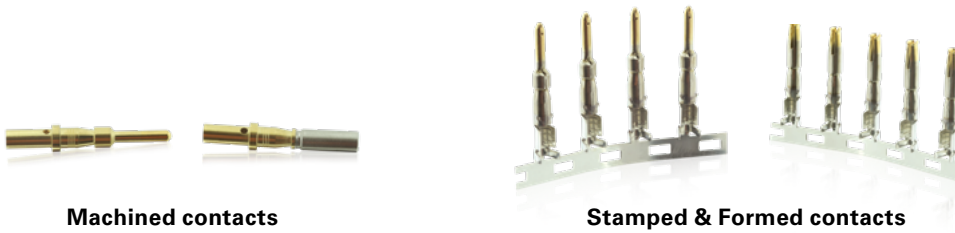

Contact plating selector guide

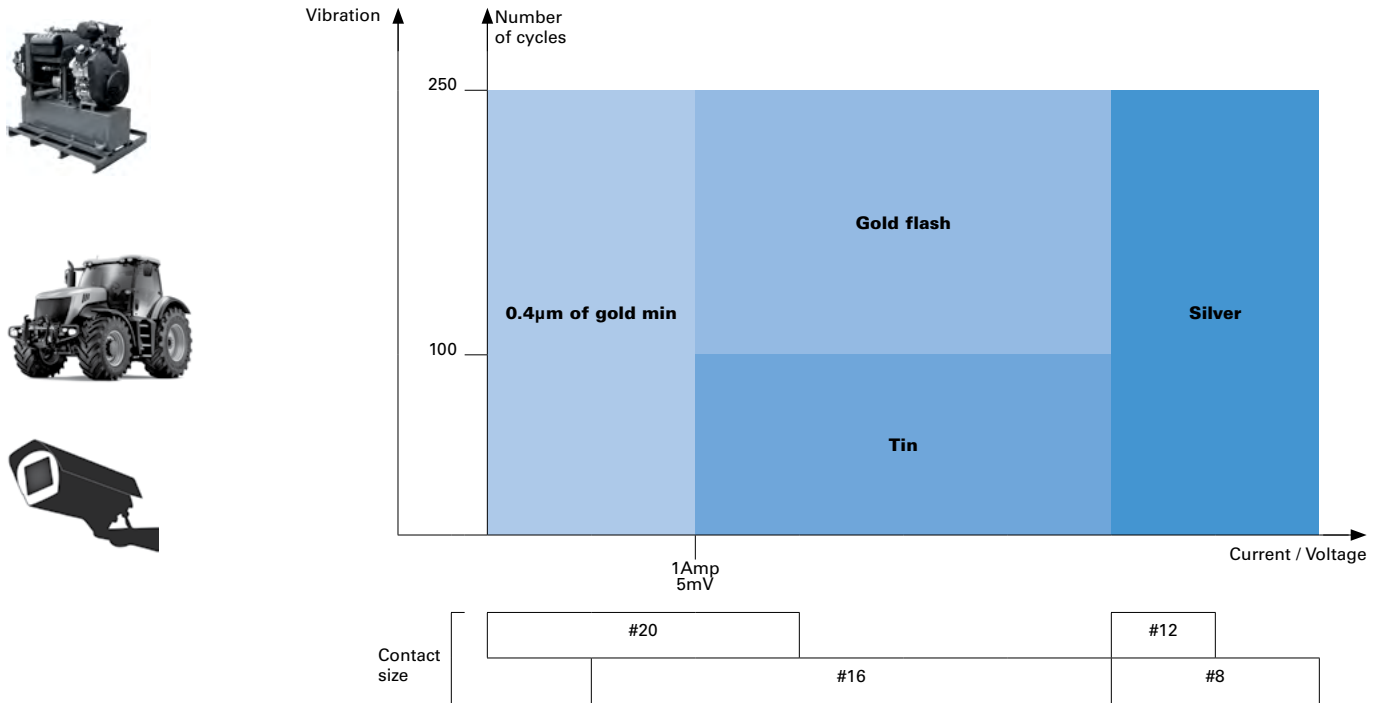

CLIPPER contacts are available in a wide variety of packaging, from very small quantities (small bulk packaging) to very large quantities (reeled parts).

Stamped & Formed contacts



Description	Number
Bulk package	100 pieces
Reeled	5,000 pieces

3

Machined contacts



Description	Number
Bulk package	100 pieces
Bulk package	200 pieces
Bulk package	500 pieces

3

Contacts

Machined contacts

Crimp and solder version

3



Contact size	Type	Wire size AWG	mm ²	Part number Male	Female	Max insulator Ø inches	mm	Available plating	Packaging
#20 Ø 0.039" / Ø1mm	Crimp	24-18	0.21-0.93	CM10PC10MQ	CM10SC10MQ	0.05-0.08	1.2-2.1	MQ*	Bulk
	Solder	18 max	Up to 0.93 mm ²	CM10PS10MQ	CM10SS10MQ	0.05-0.08	1.2-2.1	MQ*	Bulk
	Reducing sleeve	30-24	0.06-0.21	CM10PC20MQ	CM10SC20MQ	0.05-0.08	1.2-2.1	MQ*	Bulk
#16 Ø 0.062" / Ø1.6mm	Crimp	18-14	0.93-1.91	CM16PC10MQ	CM16SC10MQ	0.08-0.12	2-3	MQ*	Bulk
	Solder	14 max	Up to 1.91 mm ²	CM16PS10MQ	CM16SS10MQ	0.08-0.12	2-3	MQ*	Bulk
	Crimp	18-13	0.93-2.60	CM16PC00LY	CM16SC00LY	0.08-0.12	2-3	MQ*	Bulk
	Reducing sleeve	20	0.21-0.60	CM16PC20MQ	CM16SC20MQ	0.08-0.12	2-3	MQ*	Bulk

* Plating MQ: 0.4µm gold on active part (0.016µ inches)

Extended ground contact-crimp (Length + .039 inch = +1 mm)



Contact size	Type	Wire size AWG	mm ²	Part number Male	Max insulator Ø inches	mm	Packaging
#20 Ø 0.039" / Ø1mm	Crimp	24-18	0.21-0.93	8501 9641	0.05-0.08	1.2-2.1	Bulk
#16 Ø 0.062" / Ø1.6mm	Crimp	18-14	0.93-1.91	8501 9642 CL	0.08-0.12	2-3	Bulk

PCT machined contact



Contact size	Part number	Available plating	Packaging
#20 Ø 0.039" / Ø1mm	CM10PT10LY	LY*	Bulk
#16 Ø 0.062" / Ø1.6mm	CM16PT10LY	LY*	Bulk

* Plating LY: 0.4µm Gold (0.014µ inches) over 1µm Nickel mini (0.036µ inches)

Crimp with strain relief version



3

Contact size	Wire size AWG	mm ²	Part number Male	Female	Max insulator Ø inches	mm	Available plating	Packaging
#20 Ø 0.039" Ø1mm	22-20	0.35-0.6	CF10PC10RF	CF10SC10RF	0.05-0.08	1.2-2.1	RF*	Bulk
	22-20	0.35-0.6	CF10PC18RF	CF10SC18RF	0.05-0.08	1.2-2.1	RF*	5.000 pieces
#16 Ø 0.062" Ø1.6mm	18-16	0.7-1.5	CF16PC10RF	CF16SC10RF	0.08-0.12	2-3	RF*	Bulk
	18-16	0.7-1.5	CF16PC18RF	CF16SC18RF	0.08-0.12	2-3	RF*	5.000 pieces

Plating RF: gold flash on active part for standard version

Filler plug # 16



Description	Part number
For un-used contact cavities	8500 479 CL

Filler plug # 20



Description	Part number
For un-used contact cavities	8500 4144

Polarization contact



Description	Part number
Instruction for polarizing connector - see page 33	CP16SW9700

Automatic crimping tools

Contact Mecal for semi-automatic production tools.

Mecal sales network:
www.mecal.net

4

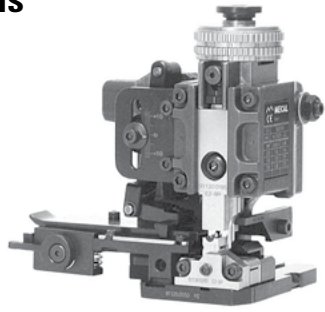

Min Applicator

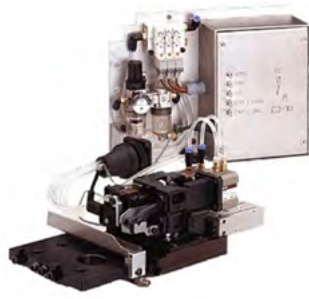

Stripper



Presses

Crimp tooling - Machined contact #20 & 16

Tooling



Description	Part number
For machined contact #20 & 16	8365 (M 22520/1-01)

Locator



Description	Part number
For machined contact #20 & 16	8365-02 (M 22520/1-02)

Crimp tooling - Stamped and formed contact #20 & 16

Tooling



Description	Part number
Handle (without head)	SHANDLES
Box containing handle and several crimp tooling	Toolkit

Crimp tooling



Description	Part number
Crimp tooling for contact #20 (without Shandles)	S20CFSP (20)
Crimp tooling for contact #16 (without Shandles)	S16CFSP (16)
Heads to be used with handle PN: SHANDLES	

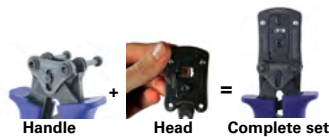

Stripping & cutting dimensions of outer jacket

Use the upmost care when stripping:

- Use stripping pliers appropriate for the cable gauge

- In order to obtain a correct crimping and to maintain all of the connector sealing characteristics, the wires must have the dimensions described below

Jacketed cable stripping length

- Make a 90° cut at the cable end
- Carefully make an incision in order to remove the cable

protection on a length L as described.

4

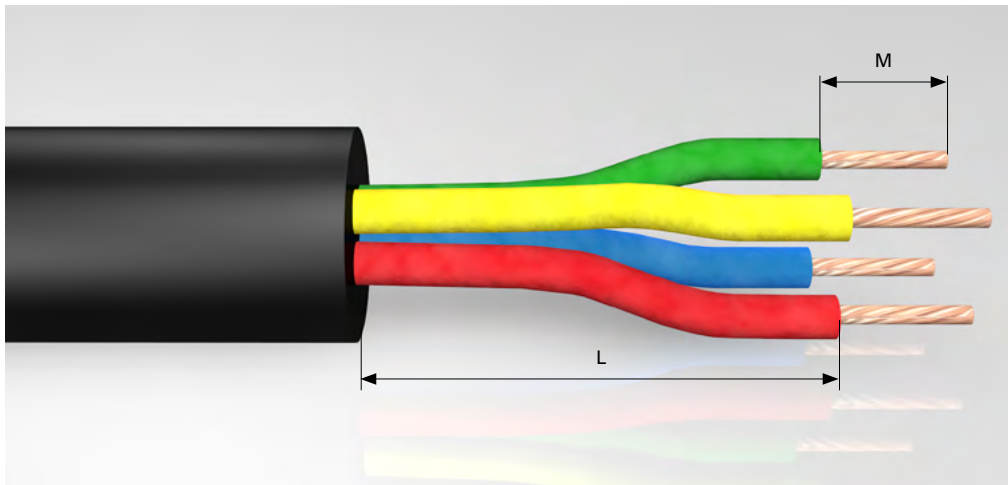

Caution:

This operation should be performed without deterioration of wire insulation.

Then, follow the normal stripping instructions:

- single wire with machined crimping contacts
- single wire with stamped and formed crimping contacts

Wire stripping length

Contact size	Stripping length M inches	mm
Machined contact #20 over insulation < 2 mm / 0.08"	0.20	5
Machined contact #20 over insulation > 2 mm / 0.08"	0.27	7
Machined contact #16	0.236	6
Stamped & formed #20 & #16	0.157	4

Cable stripping length

Shell size	Stripping length L inches	mm
1	2.36	60
2	2.56	65
3	2.56	65
4 layout 26	3.15	80
4 layout 40	3.94	100

4

Technical information

Handle & interchangeable heads for crimp contacts

Crimping with Souriau tooling

4



1) Fully close then release the tool, keep it open. Open the two pins.

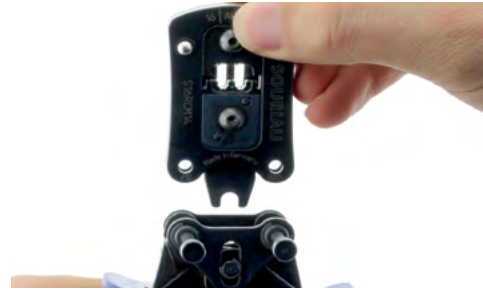

2) Choose the adapter head (sold separately). Keep vertical and slide it into the handle until the mechanical stop.



3) Close the two pins simultaneously to maintain the head.

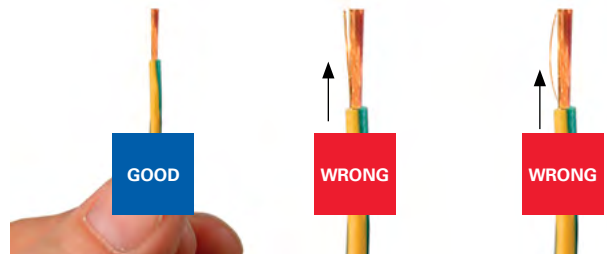

4) Strip the cable properly by checking the recommended size in the catalog on page 27.

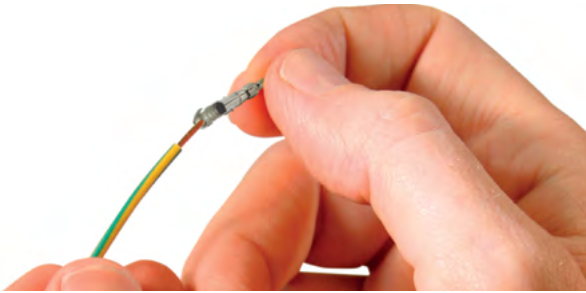

5) Place conductors, with no deterioration, in the contact bucket. All strands to be located in the crimp bucket.



6) Position the contact in the bottom of the tool by checking its orientation. Maintain the wire in position.



7) Tighten the handles to the end of the mechanism (max 175 N). After handles are opened, extract the contact.

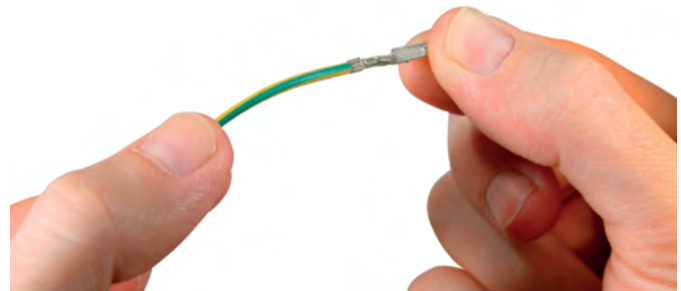

8) Control the quality of crimping.

Note: Assembly operations mentioned above shall not interfere or to be in contradiction with IPC-WHMA-A-620B

Insertion of contacts

Single wires

Contact insertion and extraction is performed without a tool thanks to the retainer plate system.



1) With the thumb and index finger, squeeze the retainer plate flaps.



2) Pull backwards. The plate is then in the unlocked position.

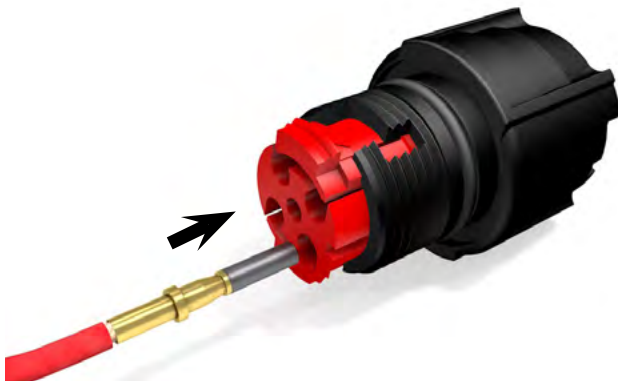

3) Fully insert the wired contact in the cavity.

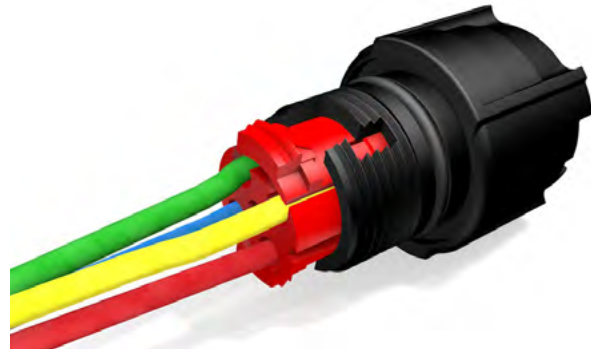

4) Repeat the same procedure for the other contacts.

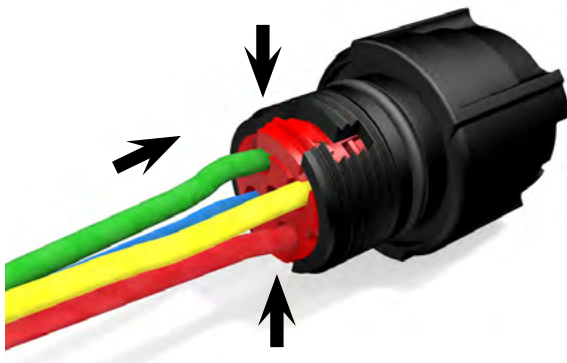

5) Once again squeeze the retainer plate flaps and push forward. The plate is then locked and retains the contacts

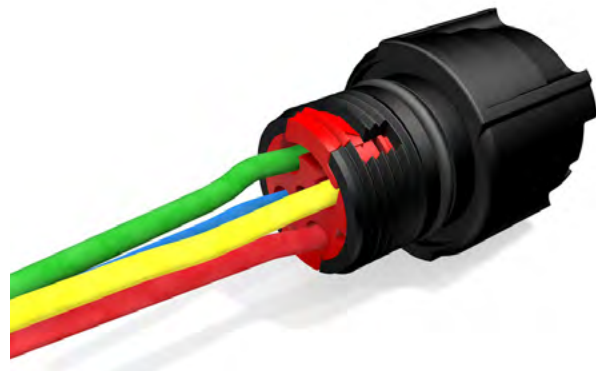

6) The plate can only be pushed back if the contacts are correctly engaged (backup security).
90 N of retention force for contacts of 1.6 mm diameter.

Extraction of contacts

Single wires

Contact insertion and extraction is performed without a tool thanks to the retainer plate system.

4

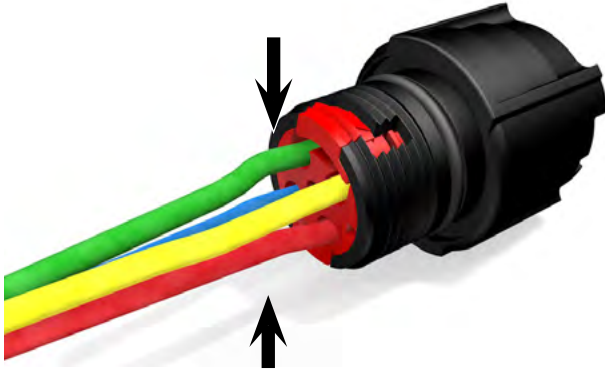

1) With the thumb and index finger, squeeze the retainer plate flaps.

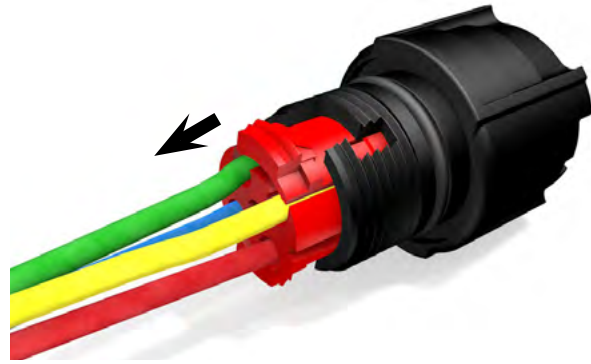

2) Pull backward. The plate is then in the unlocked position.

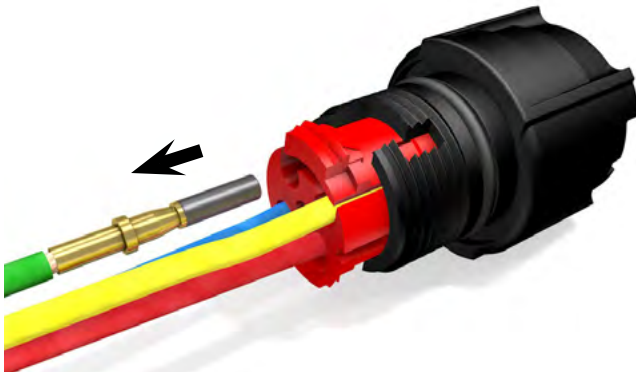

3) Pull the contact wire. The contact comes out of the cavity.

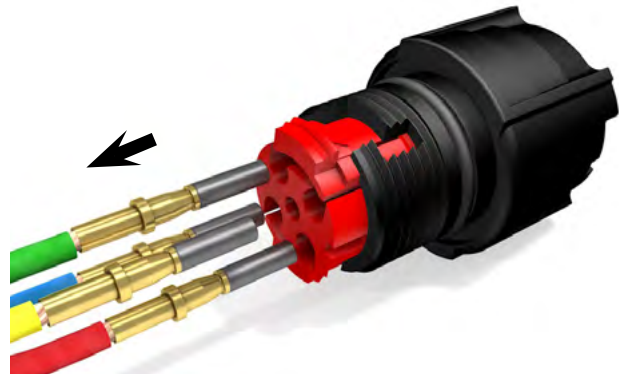

4) Repeat the same procedure for the other contacts.

Plug with anti-decoupling sealing gland assembly

4



1) Strip external cable jacket and wires (see page 27).



2) Locate the first contact and the corresponding cavity. Unlock the retainer plate as described page 32. Fully insert the wired contact in the cavity.

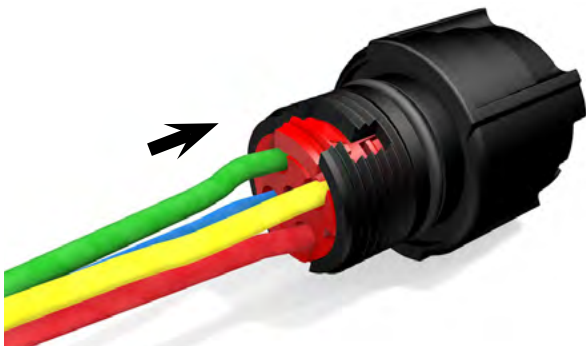

3) Respect the same procedure for the other contacts. Once again squeeze the retainer plate flaps and push forward. The plate is then locked.

Note: The plate can only be pushed back if the contacts are correctly engaged (backup-security).



4) Manually fully screw the backshell on the connector. Caution. In the sealed version, don't forget the O-ring.



5) Push the cable forwards into the backshell.

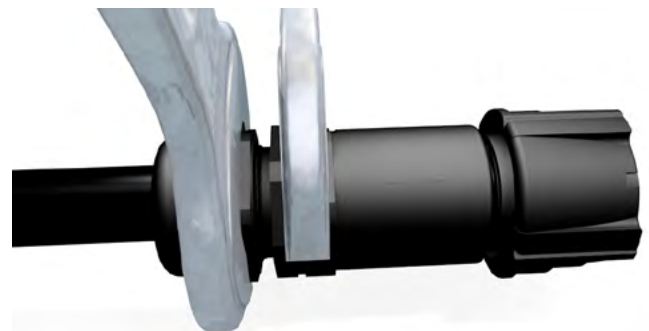

6) Fully screw on the backshell with a wrench while holding the adaptor with another wrench.

Grommet backshell assembly

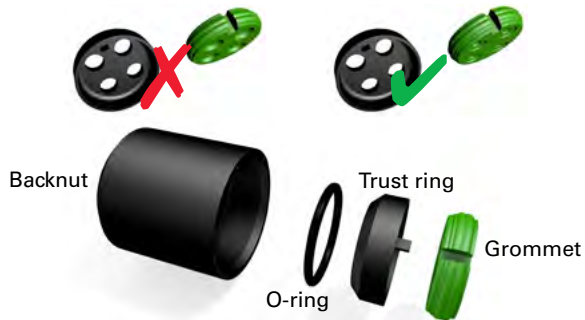

4

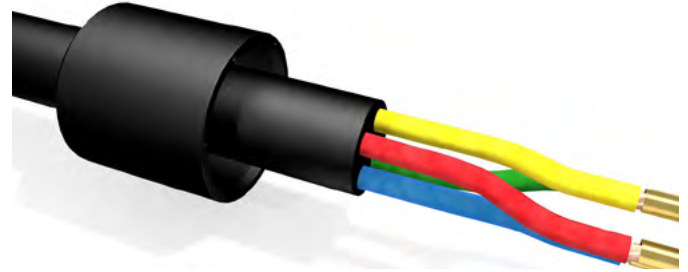

1) Position the O-ring at the bottom of the baknut.
When inserting the grommet into the trust ring, make sure that the small cavity of the grommet is facing towards the exterior.

2) Run the backnut around the cable.



3) Unlock the retainer plate.



4) Position the grommet in the thrust ring, resting against the retainer plate.



5) Insert the contacts through the grommet and the retainer plate.



6) Lock the retainer plate.



7) Screw the backshell.

Polarizing connector mounting

When the insert is partially filled with contacts, place polarization contact (part number: CP16SW9700) into selected hole location in the FEMALE INSERT and push in until seated.

Polarization contacts are used in the socket-cavities of standard plugs and reverse receptacles to provide keying capabilities for the **CLIPPER series**.

In order to lock the couple of chosen connectors, you have to let free the cavity in front of the polarization contact. To avoid connection with other connectors, you must insert a contact in the cavity in front of the polarization contact.

4

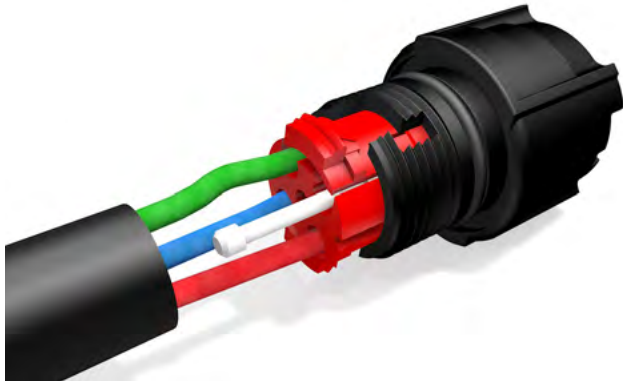

Panel mounting

Maximum wall thickness: 4mm, 0.157 inch.

Front mounting



Rear mounting

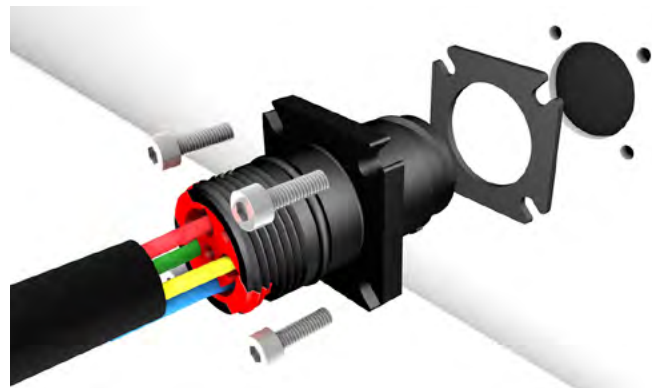

Note: Respect the coupling torques indicated M3 (all shells): 0.70 N.m Max

Protection provided by an enclosure

For safety reasons, electrical equipment needs to be protected against outside influences. The basis for the determination is the standard IEC 60529. IP is a coding system that provides information regarding the accessibility of live parts against ingress of water or other foreign bodies.

4

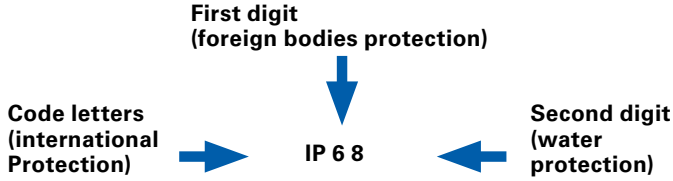

1st digit	Degree of protection	2nd digit	Degree of protection
0	No protection against accidental contact. No protection against solid foreign bodies.	0	No protection against water.
1	Protection against contact with any large area by hand and against large solid foreign bodies with a diameter bigger than 48 mm.	1	Drip-proof. Protection against vertical water drips.
2	Protection against contact with the fingers. Protection against solid foreign bodies with a diameter bigger than 12 mm.	2	Drip-proof. Protection against water drips up to a 15° angle.
3	Protection against tools, wires or similar objects with a diameter bigger than 2.5 mm. Protection against small solid bodies with a diameter bigger than 2.5 mm.	3	Spray-proof. Protection against diagonal water drips up to a 60° angle.
4	Same as 3 however diameter is bigger than 1 mm.	4	Splash-proof. Protection against splashed water from all directions.
5	Full protection against contact. Protection against interior injurious dust deposits.	5	Hose-proof. Protection against water (out of a nozzle) from all directions.
6	Total protection against contact. Protection against penetration of dust.	6	Protection against powerful water jets .
		7	Protection against temporary immersions.
		8	Protection against water pressure. Pressure and immersion time to be specified by supplier.
		9K	High pressure hose-proof. Protection against high pressure water (out of a nozzle) from all directions.

In addition to the IEC 60529 we conjointly use the ISO 20653 for the implementation of IPx9K testing:

CLIPPER offers high sealing:
IP68 even in dynamic situations.

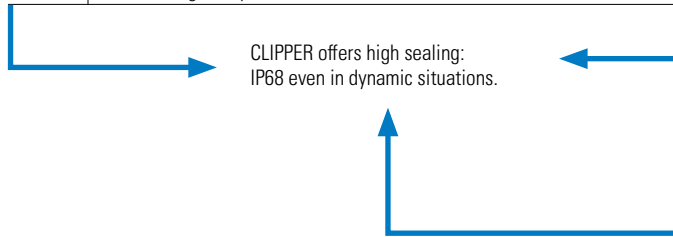

Eaton
1000 Eaton Boulevard
Cleveland, OH 44122
United States
Eaton.com

Aerospace Group
Souriau S.A.S
9, Rue de la Porte de Buc
78000 Versailles
France
Eaton.com

For more informations:
technical.emear@souriau.com
(Europe-Asia-Africa)
technical.americas@souriau.com
(North America)

© 2021 Eaton
All Rights Reserved
Document No. CACLIPPER01
October 2021

Eaton is a registered trademark.

All other trademarks are property
of their respective owners.



Follow us on social media to get the latest
product and support information.

