

## Features

- Working voltage 3.3 V
- SMT - DFN package
- Low capacitance - 4 pF
- IEC 61000-4-2 (ESD)
- IEC 61000-4-4 (EFT)
- IEC 61000-4-5 (Surge)

## Applications

- FireWire, T1/E1, T3/E3 chip side protection
- Digital Visual Interface (DVI)
- Ethernet 10/100/1000 Base T
- High speed port protection
- Portable electronics

# CDDFN10-3304NA - TVS/Steering Diode Array

## General Information

The CDDFN10-3304NA device provides ESD, EFT and Surge protection for high speed data ports, assisting compliance with IEC 61000-4-2 (ESD), IEC 61000-4-4 (EFT) and IEC 61000-4-5 (Surge) requirements. The Transient Voltage Suppressor array, protecting up to 4 data lines, offers a Working Peak Voltage of 3.3 V.

The DFN-10 packaged device will mount directly onto the industry standard DFN-10 footprint. Bourns® Chip Diodes are easy to handle with standard pick and place equipment.

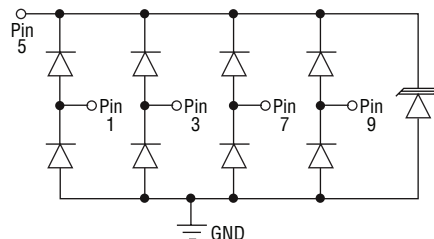

## Absolute Maximum Ratings, $T_A = 25\text{ }^\circ\text{C}$ (Unless Otherwise Noted)

Parameter	Symbol	CDDFN10-3304NA	Unit
Peak Pulse Current ( $t_p = 8/20\ \mu\text{s}$ ) per IEC 61000-4-5	$I_{PP}$	25	A
ESD Protection per IEC 61000-4-2			
Contact Discharge		$\pm 30$	kV
Air Discharge		$\pm 30$	kV
EFT Protection per IEC 61000-4-4 @ 5/50 ns		40	A
Storage Temperature	$T_{STG}$	-55 to +150	$^\circ\text{C}$
Operating Temperature	$T_{OPR}$	-55 to +125	$^\circ\text{C}$

## Electrical Characteristics (@ $T_A = 25\text{ }^\circ\text{C}$ Unless Otherwise Noted)

Parameter	Symbol	Min.	Typ.	Max.	Unit
Breakdown Voltage @ 1 mA	$V_{BR}$	3.9			V
Reverse Working Peak Voltage	$V_{RWM}$			3.3	V
Leakage Current <sup>1</sup> @ $V_{RWM}$	$I_D$			1	$\mu\text{A}$
Clamping Voltage <sup>2</sup> @ $I_P = 5\ \text{A}$ 8/20 $\mu\text{s}$	$V_C$			12	V
Clamping Voltage <sup>2</sup> @ $I_P = 15\ \text{A}$ 8/20 $\mu\text{s}$	$V_C$			15	V
Clamping Voltage <sup>2</sup> @ $I_P = 25\ \text{A}$ 8/20 $\mu\text{s}$	$V_C$			18	V
Junction Capacitance <sup>2</sup> @ 0 V 1 MHz	$C_D$		4.0	4.6	pF
Junction Capacitance <sup>3</sup> @ 0 V 1 MHz	$C_{IO}$		1.5	2.3	pF

Note 1: Pin 5 to ground.

Note 2: Pin 1,3,7 or 9 to ground.

Note 3: Between Pin 1,3,7 and 9.

\*RoHS Directive 2002/95/EC Jan. 27, 2003 including annex and RoHS Recast 2011/65/EU June 8, 2011.

Specifications are subject to change without notice.

Users should verify actual device performance in their specific applications.

The products described herein and this document are subject to specific legal disclaimers set forth on the last page of this document.

## Rating & Characteristic Curves

### Pulse Waveform

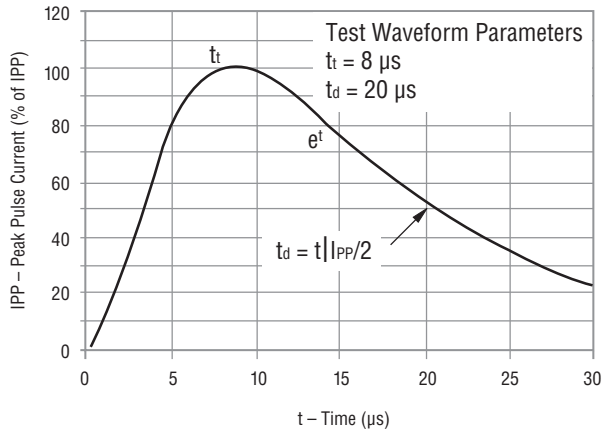

### Typical Clamping Voltage vs Peak Pulse Current

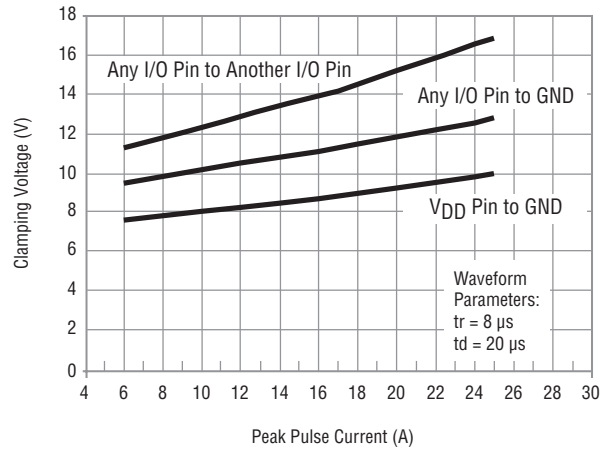

### Typical Transmission Line Pulsing (TLP) Measurement

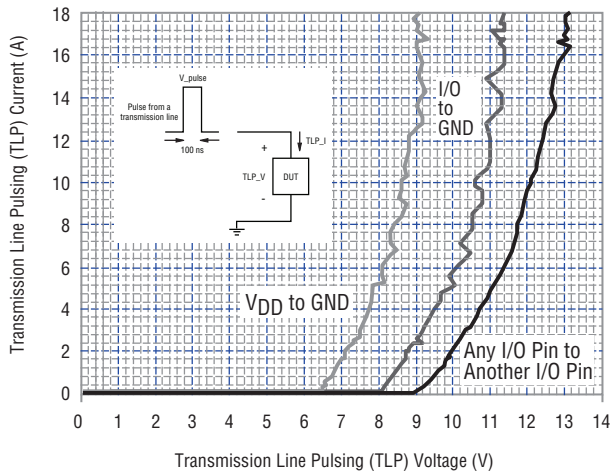

### Typical Voltage vs. Capacitance

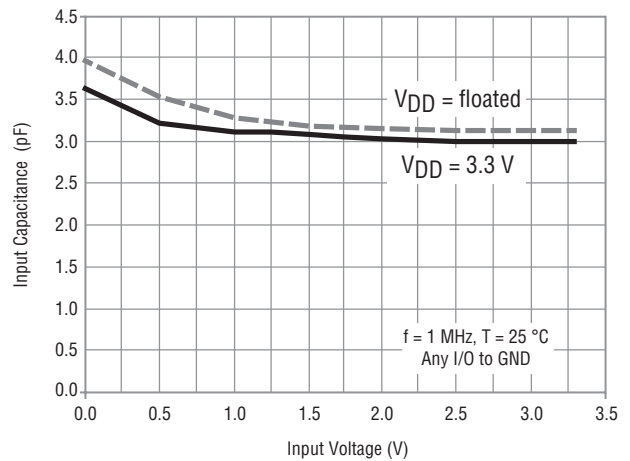

### Typical Power Derating Curve

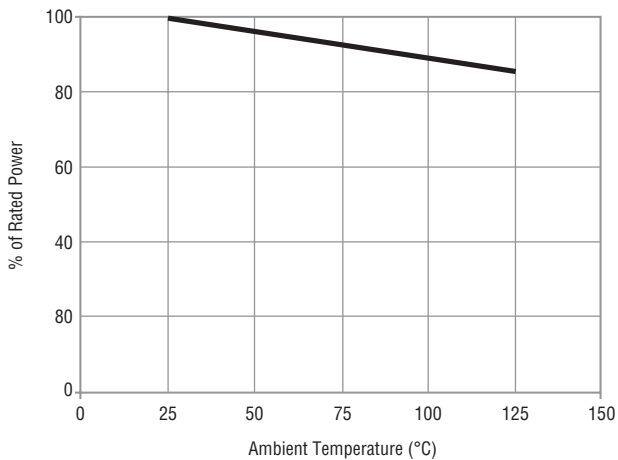

Specifications are subject to change without notice. Users should verify actual device performance in their specific applications. The products described herein and this document are subject to specific legal disclaimers set forth on the last page of this document.

# CDDFN10-3304NA - TVS/Steering Diode Array



## Product Dimensions

This is a molded DFN10 package with lead free Nickel-Paladium-Gold (Ni/Pd/Au) on the lead frame. It has a flammability rating of UL 94V-0.

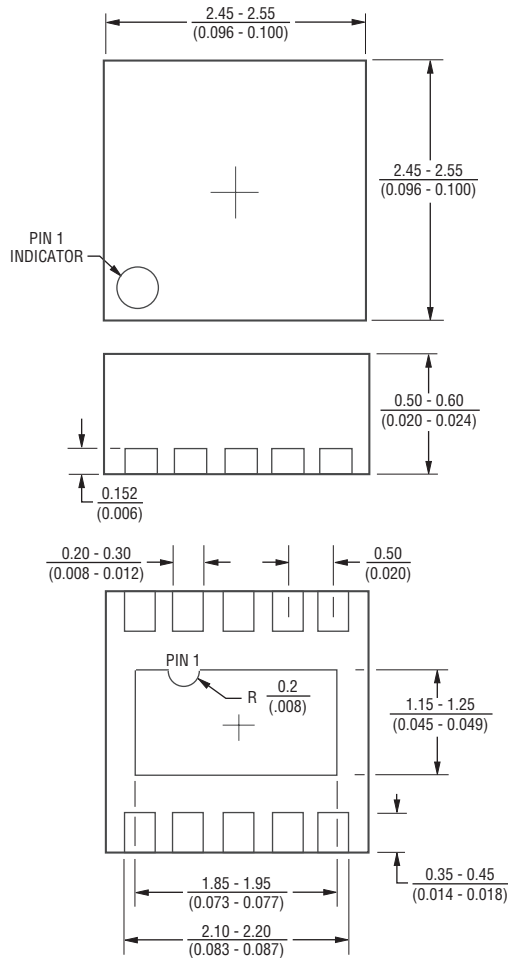

## Recommended Footprint

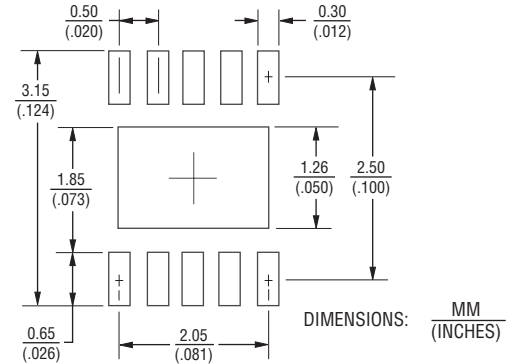

## Typical Part Marking

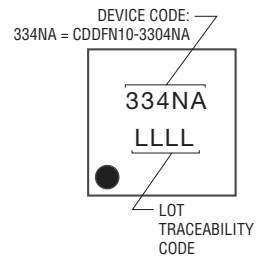

## Pin Out

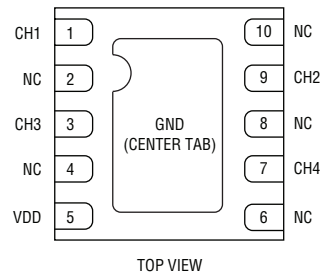

Pin	Function
1	I/O
2	N.C.
3	I/O
4	N.C.
5	V <sub>DD</sub>
6	N.C.
7	I/O
8	N.C.
9	I/O
10	N.C.
CENTER TAB	GROUND

## How to Order

**CD DFN10 - 33 04 NA**

Common Diode \_\_\_\_\_  
 Chip Diode \_\_\_\_\_  
 Package \_\_\_\_\_  
 DFN10 = DFN-10 Package \_\_\_\_\_  
 Reverse Working Peak Voltage \_\_\_\_\_  
 33 = 3.3 V<sub>RWM</sub> (Volts) \_\_\_\_\_  
 Number of Lines \_\_\_\_\_  
 04 = 4 Data Lines \_\_\_\_\_  
 Suffix \_\_\_\_\_  
 NA = Low Capacitance \_\_\_\_\_

## Environmental Specifications

Moisture Sensitivity Level.....3  
 ESD Classification (HBM).....3B

Specifications are subject to change without notice.  
 Users should verify actual device performance in their specific applications.  
 The products described herein and this document are subject to specific legal disclaimers set forth on the last page of this document.

# CDDFN10-3304NA - TVS/Steering Diode Array

**BOURNS®**

## Packaging Information

The product will be dispensed in tape and reel format (see diagram below).

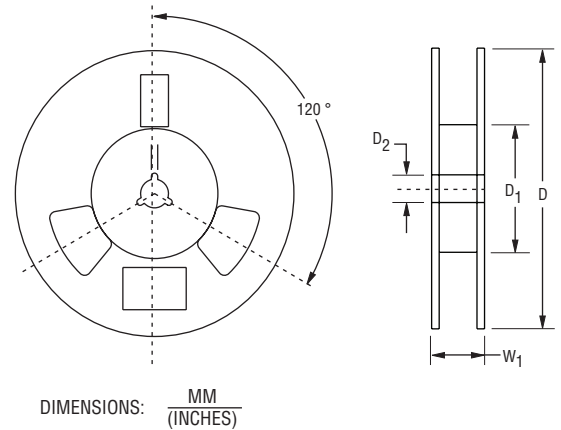
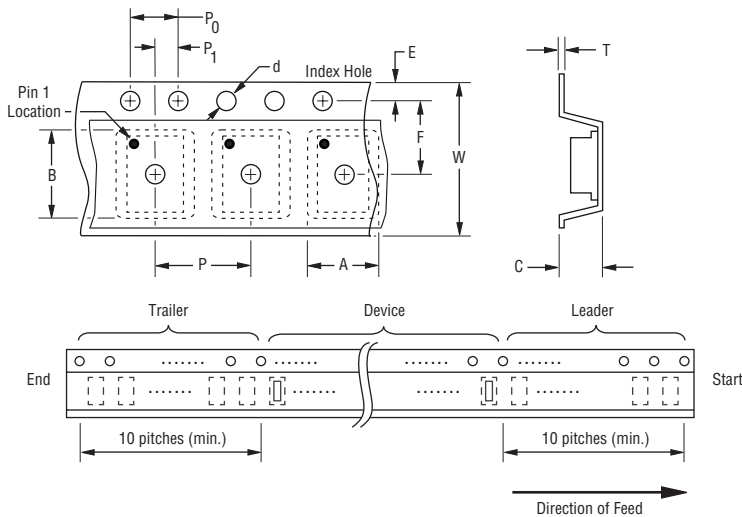

Devices are packed in accordance with EIA standard RS-481-A.

Item	Symbol	DFN-10
Carrier Width	A	$\frac{1.2 \pm 0.05}{(0.047 \pm 0.002)}$
Carrier Length	B	$\frac{2.7 \pm 0.05}{(0.106 \pm 0.002)}$
Carrier Depth	C	$\frac{0.7 \pm 0.05}{(0.028 \pm 0.002)}$
Sprocket Hole	d	$\frac{1.5 \pm 0.05}{(0.059 \pm 0.002)}$
Reel Outside Diameter	D	$\frac{180 \pm 3}{(7.087 \pm 0.118)}$
Reel Inner Diameter	D <sub>1</sub>	$\frac{50.0}{(1.969)}$ MIN.
Feed Hole Diameter	D <sub>2</sub>	$\frac{13.00 \pm 0.20}{(0.512 \pm 0.008)}$
Sprocket Hole Position	E	$\frac{1.75 \pm 0.10}{(0.069 \pm 0.004)}$
Punch Hole Position	F	$\frac{3.50 \pm 0.05}{(0.138 \pm 0.002)}$
Punch Hole Pitch	P	$\frac{4.00 \pm 0.10}{(0.157 \pm 0.004)}$
Sprocket Hole Pitch	P <sub>0</sub>	$\frac{4.00 \pm 0.10}{(0.157 \pm 0.004)}$
Embossment Center	P <sub>1</sub>	$\frac{2.00 \pm 0.05}{(0.079 \pm 0.002)}$
Overall Tape Thickness	T	$\frac{0.60}{(0.024)}$ MAX.
Tape Width	W	$\frac{12.3}{(0.484)}$ MAX.
Reel Width	W <sub>1</sub>	$\frac{18.4}{(0.724)}$ MAX.
Quantity per Reel	--	3000

**BOURNS®**

### Asia-Pacific:

Tel: +886-2 2562-4117

Email: asiacus@bourns.com

### Europe:

Tel: +36 88 520 390

Email: eurocus@bourns.com

### The Americas:

Tel: +1-951 781-5500

Email: americus@bourns.com

[www.bourns.com](http://www.bourns.com)

10/17

Specifications are subject to change without notice. Users should verify actual device performance in their specific applications. The products described herein and this document are subject to specific legal disclaimers set forth on the last page of this document, and at [www.bourns.com/docs/legal/disclaimer.pdf](http://www.bourns.com/docs/legal/disclaimer.pdf).